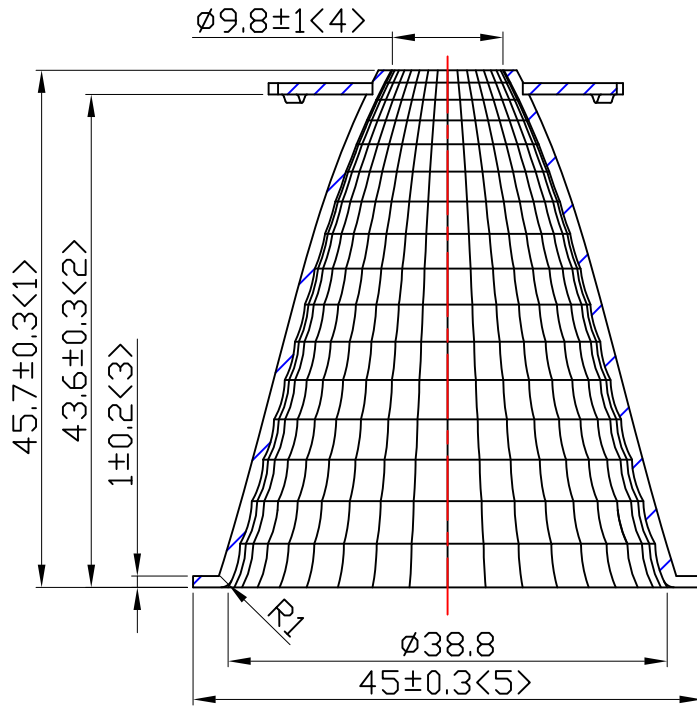
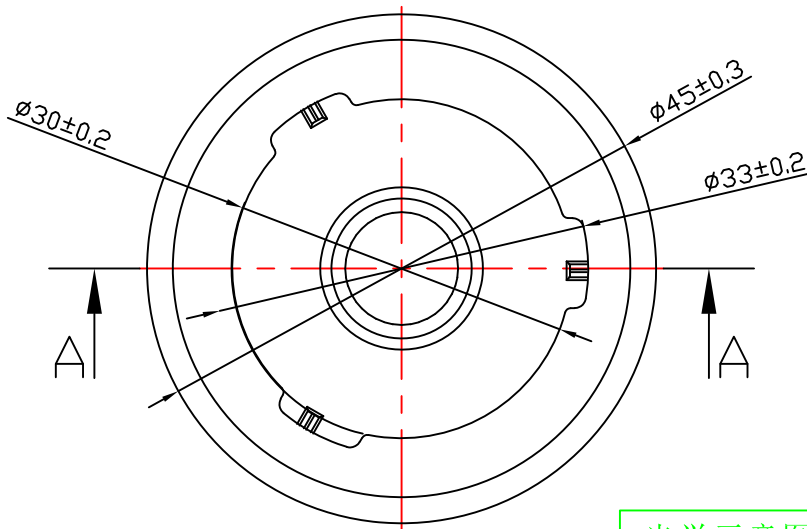

Table for unmentioned tolerance in the drawing (unit: mm)			punch angle tolerance in the drawing (unit: degree)		
0-5	5-30	30-120	0-10	10-50	50-120
±0.15	±0.2	±0.5	±1°	±0.5°	±0.3°
120-250	250-400	400-700	120-250	250-360	360 above
±0.8	±1.5	±2	±0.2°	±0.166°	±0.083°



A-A



Light Source	CITIZEN CLU028
Plastic Holder	92.70.124.00
Metal Adapter	97.76.753.00
Design Angle	35° ±3°
Measured Angle	34.2°
Efficiency	

光学示意图

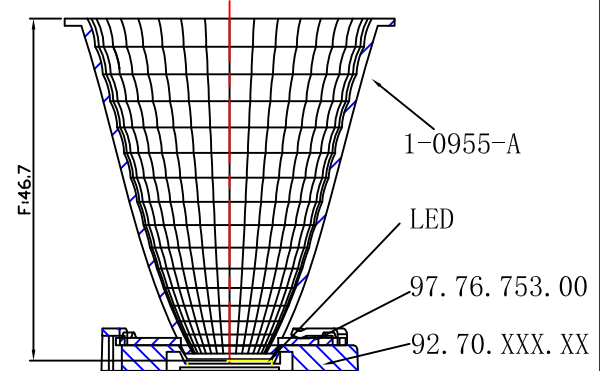

Material: 1.0 1090AL

Nata[®]
NATA Lighting Co., Ltd

Mark	Amended Times	Amended Content		Signature	Amended Date
Control Version	A0	Design Version	K2	Client Version	
Designer		Drawing by		Proportion	1:1
Technology		Auditor		View	
Approval		Date	2019.08.27	Page	Total_ Page_

Customer Item	D45深筒反光杯36°
Customer Code	NT
Product Number	91.01.0920.000
Product Name	1-0920-M