

High IP3 Frequency Mixer

SYM-20DHW+ SYM-20DHW

Level 17 (LO Power +17 dBm) 10 to 2000 MHz

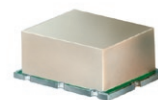

Maximum Ratings

Operating Temperature	-40°C to 85°C
Storage Temperature	-55°C to 100°C
RF Power	200mW
IF Current	40mA
Permanent damage may occur if any of these limits are exceeded.	

Pin Connections

LO	2
RF	1
IF	3
GROUND	4,5,6

Features

- low conversion loss, 6.2 dB typ.
- high IP3, 27 dBm typ.
- wideband, 10 to 2000 MHz
- excellent L-R isolation, 42 dB typ.;
- & L-I isolation, 40 dB typ.
- triple balanced mixer

Applications

- GPS
- UHF

CASE STYLE: TTT167
PRICE: \$17.95 ea. QTY (1-9)

**+ RoHS compliant in accordance
with EU Directive (2002/95/EC)**

The +Suffix identifies RoHS Compliance. See our web site for RoHS Compliance methodologies and qualifications.

Outline Drawing

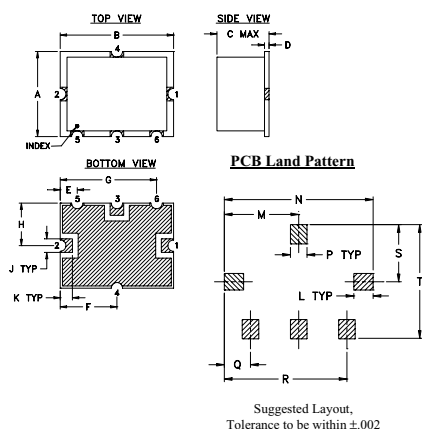

Outline Dimensions (inch mm)

A	B	C	D	E	F	G	H	J	K
.38	.50	.23	.020	.075	.250	.425	.187	.050	.050
9.65	12.70	5.84	0.51	1.91	6.35	10.80	4.75	1.27	1.27
L	M	N	P	Q	R	S	T	wt.	
.070	.270	.540	.060	.095	.445	.208	.415	grams	
1.78	6.86	13.72	1.52	2.41	11.30	5.28	10.54	0.8	

Demo Board MCL P/N: TB-12 Suggested PCB Layout (PL-079)

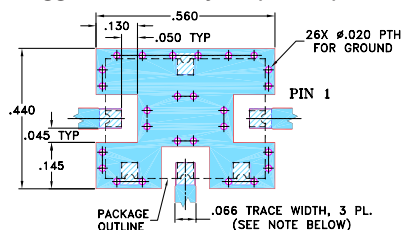

Electrical Specifications

FREQUENCY (MHz)		CONVERSION LOSS (dB)				LO-RF ISOLATION (dB)			LO-IF ISOLATION (dB)			IP3 at center band (dBm)						
LO/RF	IF	Mid-Band		Total Range	L	M	U	L	M	U								
f_L - f_U		\bar{X}	σ	Max.	Max.	Typ.	Min.	Typ.	Min.	Typ.	Min.	Typ.						
10-2000	10-1800	6.2	.10	7.5	8.8	33	20	40	25	37	22	44	30	42	28	34	22	27

1 dB COMP.: +14 dBm typ. L = low range [f_L to 10 f_U] M = mid range [10 f_L to $f_U/2$] U = upper range [$f_U/2$ to f_U]

Typical Performance Data

Frequency (MHz)		Conversion Loss (dB)	Isolation L-R (dB)	Isolation L-I (dB)	VSWR RF Port (:1)	VSWR LO Port (:1)
RF	LO	LO +17dBm	LO +17dBm	LO +17dBm	LO +17dBm	LO +17dBm
10.00	40.00	6.63	31.10	48.70	1.63	1.75
16.69	46.69	6.46	31.60	49.00	1.39	1.70
27.86	57.86	6.23	32.40	48.80	1.26	1.73
46.49	76.49	5.99	33.70	49.60	1.17	1.69
77.60	107.60	5.93	34.60	49.60	1.16	1.62
129.51	159.51	5.88	35.50	49.90	1.18	1.69
216.16	246.16	6.00	36.50	49.70	1.28	1.75
360.78	390.78	6.20	37.10	46.10	1.61	1.57
602.15	632.15	6.65	38.70	41.10	2.27	1.50
1005.00	1035.00	6.43	37.20	37.80	2.49	1.38
1104.50	1134.50	6.18	36.20	36.80	2.23	1.36
1204.00	1234.00	6.06	36.10	35.70	1.97	1.34
1303.50	1333.50	6.16	35.50	35.10	1.88	1.35
1403.00	1433.00	6.09	34.50	35.50	1.70	1.37
1502.50	1532.50	6.01	34.90	35.20	1.58	1.43
1602.00	1632.00	6.16	35.50	35.50	1.49	1.45
1700.00	1730.00	6.60	35.70	35.40	1.48	1.39
1801.00	1831.00	6.86	35.40	34.30	1.41	1.32
1900.50	1930.50	7.16	33.50	33.30	1.39	1.29
2000.00	2030.00	7.36	32.00	31.40	1.28	1.28

Electrical Schematic

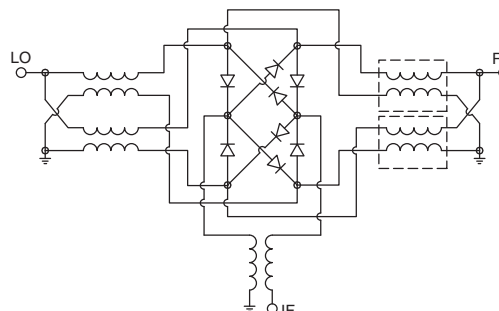

Mini-Circuits
ISO 9001 ISO 14001 AS 9100 CERTIFIED

For detailed performance specs & shopping online see web site

P.O. Box 350166, Brooklyn, New York 11235-0003 (718) 934-4500 Fax (718) 332-4661 The Design Engineers Search Engine Provides ACTUAL Data Instantly at minicircuits.com

IF/RF MICROWAVE COMPONENTS

Notes: 1. Performance and quality attributes and conditions not expressly stated in this specification sheet are intended to be excluded and do not form a part of this specification sheet. 2. Electrical specifications and performance data contained herein are based on Mini-Circuit's applicable established test performance criteria and measurement instructions. 3. The parts covered by this specification sheet are subject to Mini-Circuits standard limited warranty and terms and conditions (collectively, "Standard Terms"); Purchasers of this part are entitled to the rights and benefits contained therein. For a full statement of the Standard Terms and the exclusive rights and remedies thereunder, please visit Mini-Circuits' website at www.minicircuits.com/MCLStore/terms.jsp.

REV. C
M112207
SYM-20DHW
DJ/TD/AM
091006
Page 1 of 2

Performance Charts

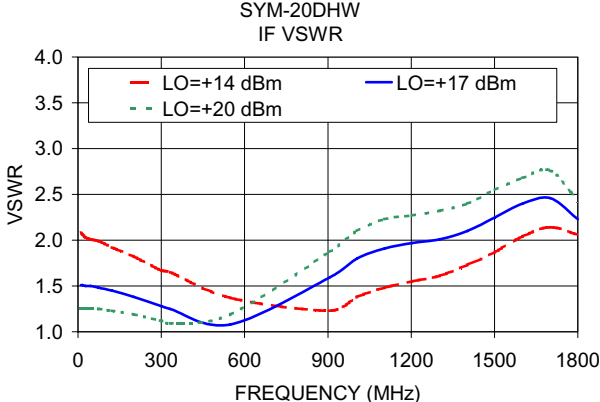
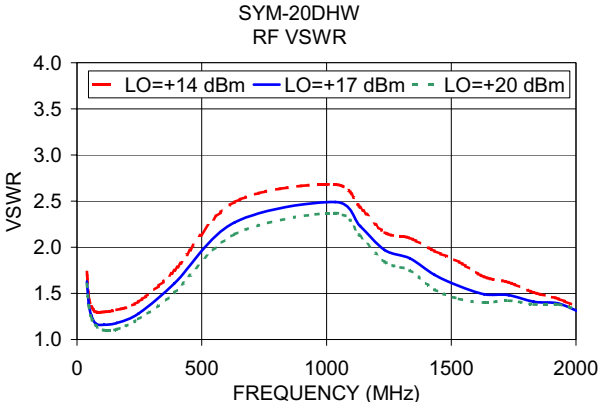
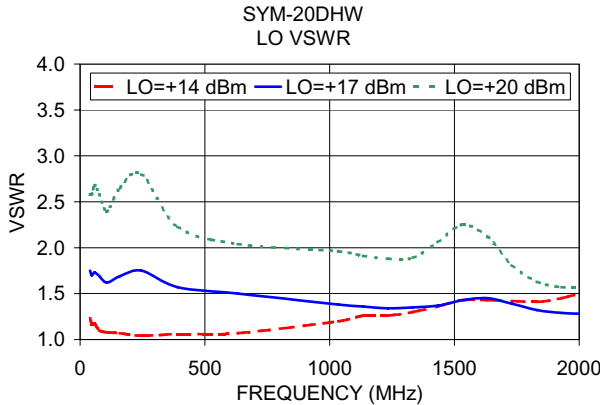
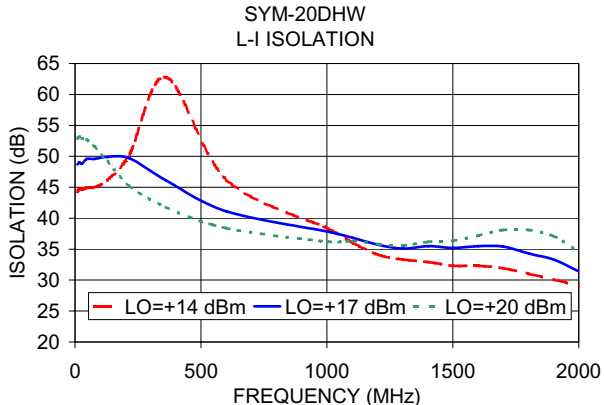
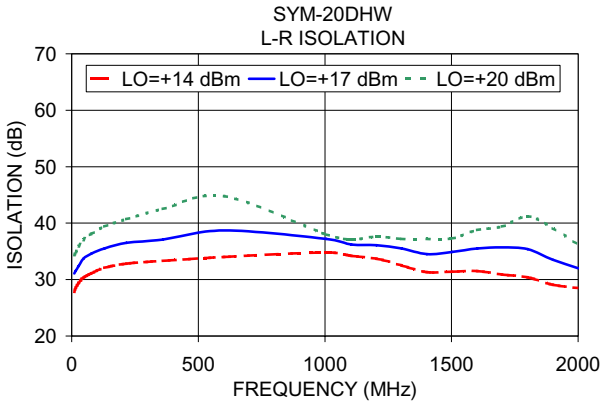
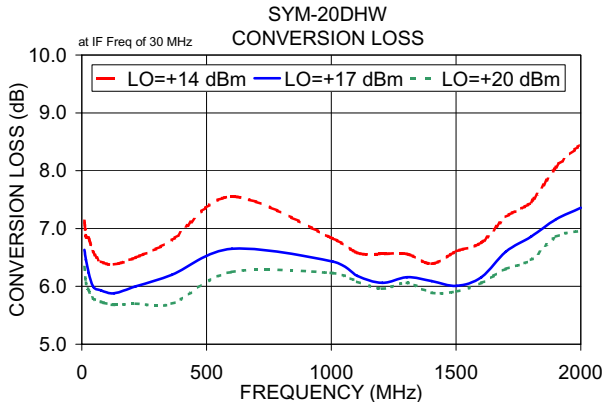

ISO 9001 ISO 14001 AS 9100 CERTIFIED

P.O. Box 350166, Brooklyn, New York 11235-0003 (718) 934-4500 Fax (718) 332-4661 The Design Engineers Search Engine Provides ACTUAL Data Instantly at minicircuits.com

IF/RF MICROWAVE COMPONENTS

For detailed performance specs & shopping online see web site

Notes: 1. Performance and quality attributes and conditions not expressly stated in this specification sheet are intended to be excluded and do not form a part of this specification sheet. 2. Electrical specifications and performance data contained herein are based on Mini-Circuit's applicable established test performance criteria and measurement instructions. 3. The parts covered by this specification sheet are subject to Mini-Circuits standard limited warranty and terms and conditions (collectively, "Standard Terms"); Purchasers of this part are entitled to the rights and benefits contained therein. For a full statement of the Standard Terms and the exclusive rights and remedies thereunder, please visit Mini-Circuits' website at www.minicircuits.com/MCLStore/terms.jsp.