

# MechaTronix *in* LED

## ModuLED Mega Modular Passive Star LED Cooler ø134mm



### Features & Benefits

- For low and high bay designs from 1,600 to 10,000 lumen
- Thermal resistance range Rth 0.67 - 1.32°C/W
- Modular design with mounting holes foreseen for a wide range of LED modules and COB's:
  - Zhaga Book 3 Spot Light Modules Edison Edilex, Osram PrevaLED Core AC, Core Z3, Philips Fortimo SLM, Tridonic Talexx Stark SLE, Vossloh Schwabe Luga Shop, ...
  - Bridgelux BXRA ES Rectangle, Vero 29
  - Citizen Citiled CLL032-CLU034, CLL042-CLU044, CLL052-CLU054
  - Cree XLamp CXA18xx, CXA25xx, CXA30xx
  - Edison EdiPower II HM16, HM30, HM40
  - GE Infusion M, DLM, NPM series LED module
  - LG Innotek LEMWM18 17W, 24W, LEMWM28 40W
  - Lustrous Lustron LL613F, LL620F, LL660D
  - Osram Soleriq S19, E30
  - Philips Fortimo DLM Gen5, Philips Lumileds Luxeon 1205, 1208, 1211
  - Prolight Opto PACC, PACD
  - Seoul Semiconductor ZC40
  - Tridonic Talexx Stark SLE GEN3 Mini LES-17, DLE GEN2 LES-65, FLE GEN1
- Direct mounting or by use of Zhaga Book 3 LED holder.
- Diameter 134mm - Standard height 20 / 50 / 100mm  
Other heights on request
- Extruded from highly conductive aluminum



### Order Information

Example : ModuLED Mega 134100-B

ModuLED Mega 134 **1** - **2**

- 1** Height (mm)
- 2** Anodising Color  
B - Black  
C - Clear

*ModuLED Mega* is designed in this way that you can mount LED modules from various manufacturers on the same LED cooler  
Simple mounting with self tapping screws  
Recommended screw force 6lb/in  
Screws are available from MechaTronix

# MechaTronix *in* LED

## ModulED Mega Modular Passive Star LED Cooler ø134mm



### Product Details

Model n°			
Dimension (mm) <sup>*1</sup>	ø134 x h20	ø134 x h50	ø134 x h100
Volume (mm <sup>3</sup> )	170110	283564	567200
Cooling Surface (mm <sup>2</sup> )	103850	165446	319435
Weight (gr)	459	766	1531
Thermal Resistance (°C/W) <sup>*2</sup>	1.32	0.88	0.67
Power Pd (W) <sup>*3</sup>	38	57	75
Heat Sink Material	AL6063-T5	AL6063-T5	AL6063-T5

<sup>\*1</sup> 3D files are available in ParaSolid, STP and IGS on request

<sup>\*2</sup> The thermal resistance Rth is determined with a calibrated heat source of 30mm x 30mm central placed on the heat sink, Tamb 40° and an open environment. Reference data @ heat sink to ambient temperature rise Ths-amb 50°C  
The thermal resistance of a LED cooler is not a fix value and will vary with the applied dissipated power Pd

<sup>\*3</sup> Dissipated power Pd. Reference data @ heat sink to ambient temperature rise Ths-amb 50°C  
The maximal dissipated power needs to be verified in function of required case temperature Tc or junction temperature Tj and related to the estimated ambient temperature where the light fixture will be placed  
Please be aware the dissipated power Pd is not the same as the electrical power Pe of a LED module

To calculate the dissipated power please use the following formula:  $Pd = Pe \times (1 - \eta_L)$

Pd - Dissipated power

Pe - Electrical power

$\eta_L$  = Light efficiency of the LED module

### Notes:

- MechaTronix reserves the right to change products or specifications without prior notice.
- Mentioned models are an extraction of full product range.
- For specific mechanical adaptations please contact MechaTronix.

# MechaTronix in LED

## ModuLED Mega Modular Passive Star LED Cooler $\phi$ 134mm



### Mounting Options

The ModuLED Mega passive LED coolers are standard foreseen from a variety of mounting holes which allow direct mounting of LED engines, COB's and secondary optics on the LED heat sink.

In this way mechanical afterwork and related costs can be avoided, and lighting designers can standardize their designs on a limited number of LED coolers.

Below you find an overview of LED modules and COB's which standard fit on the ModuLED Mega LED cooler.

The ModuLED Mega is probably the most complete standard LED cooler with regards to mounting possibilities of Zhaga and the latest generation of COB LED modules.

For more details about the required mounting holes and thermal results for your specific LED brand and model, please refer to the brand LED cooler datasheets under "Brand Products" and the brand LED cooler overview under the "Download" menu.

### Zhaga



The Zhaga Consortium is developing specifications that enable the interchangeability of LED light sources made by multiple different manufactures. The Zhaga specifications, known as Books, describe the interfaces between LED luminaires and LED light engines. Zhaga's members include hundreds of companies from throughout the global lighting industry. The cooperation is governed by a consortium agreement that defines rules regarding confidentiality, intellectual property and decision making.

#### Mounting indicator marks overview

MechaTronix recommends the use of a high thermal conductive interface between the LED module and the LED cooler. Either thermal grease, a thermal pad or a phase change thermal pad thickness 0.1-0.15mm is recommended. Thermal pads or phase change thermal pads can be pre-applied from MechaTronix.

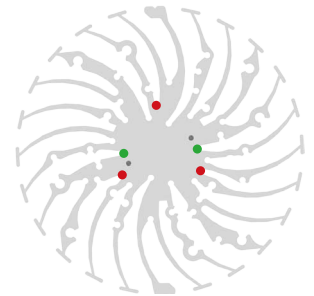

#### Zhaga Book 3 Spot Light Modules

Zhaga Interface Specification Book 3 defines the interfaces of a type-D LED light engine (non-socketable LED module with separate electronic control gear). The LED light engine LLE has a round disc shape with a maximum height of 7.2 mm and a typical diameter of 50 mm. It is suitable for spot-lighting and other applications that benefit from a small, circular source. Book 3 specifies a circular light-emitting surface (LES) that can have a range of diameters, namely 9 mm, 13.5 mm, 19 mm and 23 mm.

#### Zhaga book 3 compliant LED Spot Light modules \*1

- Edison Edilex SLM
- Osram PrevaLED CORE
- Philips Fortimo SLM
- Tridonic Talexx Stark SLE
- Vexica Lumaera
- Vossloh Schwabe Luga Shop

\*1 This is a non-binding overview of available Zhaga book 3 LED modules at press

#### Zhaga Book 3 mounting through the use of LED holders and connectors

With the use of Zhaga Book 3 mechanical compatible LED holders, a wide variety of LED COB's can be mounted in the same way on these LED coolers.

Zhaga Book 3 compatible LED holders can be found from BJB, TE Connectivity (Tyco), Molex and Ideal Industries.



# MechaTronix in LED

## ModuLED Mega Modular Passive Star LED Cooler ø134mm



### Mounting Options



#### Zhaga Book 3 Spot Light Modules

##### LED COB's for which Zhaga book 3 LED holders are available

- Bridgelux ES rectangular LED array
- Citizen CitiLED CLL032, CLU034, CLL042, CLU044
- Cree XLamp CXA18xx, 25xx, 30xx
- Edison Opto HM16, HM30, HM40
- Lextar Nimbus 1500, 2000, 3000
- LG Innotek LEMWM18 (10W, 13W, 17W, 24W), LEMWM28 (40W)
- Lustrous Lustron LL613F, LL620F, LL630F, LL630D, LL660D
- Nichia J216, J360, L110, L121, L204
- Osram Soleriq S13, S19, E30
- Philips Lumileds Luxeon 1203, 1204, 1205 and 1208, Luxeon K12 and K16
- Prolight Opto PABA, PACC, PACD
- Samsung LC026, LC040
- Seoul Semiconductor ZC12, ZC18, ZC25, ZC40
- Sharp Mega Zenigata and Tiger Zenigata
- Tridonic Talexx Stark SLE Gen3 Mini LES 17

##### Mounting

- Direct mounting with 2 self tapping screws M3 x 6mm  
Green indicator marks

##### Reflector ring Mounting

- This optional ring can be mounted on top of the Edison Opto EdiLex spot light module and provides in this way an easy plug-and-play attachment of various reflectors.
- Mounting with 3 self tapping screws M3 x 10mm  
Red indicator marks

# MechaTronix *in* LED

## ModulED Mega Modular Passive Star LED Cooler ø134mm



### Mounting Options

#### Bridgelux LED Arrays



Bridgelux is a leading provider of high power, cost effective and energy efficient light emitting diode (LED) solutions. Leveraging patented light source technology, Bridgelux LED Arrays replace traditional technologies (such as incandescent, halogen, fluorescent and high intensity discharge lighting) with integrated solid state light sources enabling high performance and energy-efficient products for the general lighting market.

#### Mounting indicator marks overview

MechaTronix recommends the use of a high thermal conductive interface between the LED module and the LED cooler. Either thermal grease, a thermal pad or a phase change thermal pad thickness 0.1-0.15mm is recommended. Thermal pads or phase change thermal pads can be pre-applied from MechaTronix.

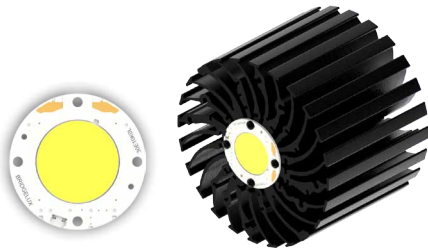
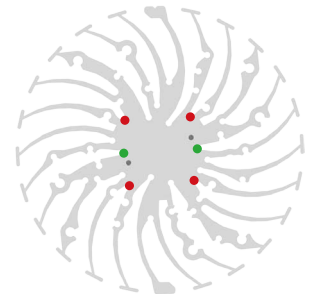

#### Bridgelux Vero 29 LED Array

##### Model names

- Vero 29 BXRC-27x10K0
- Vero 29 BXRC-30x10K0
- Vero 29 BXRC-35E10K0
- Vero 29 BXRC-40E10K0
- Vero 29 BXRC-50C10K0

##### Mounting

- Direct mounting with 4 self tapping screws M3 x 6mm
- Red indicator marks

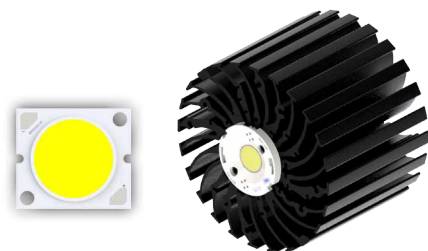

#### Bridgelux ES Rectangle LED Array

##### Model names

- BXRA-xxx0800
- BXRA-xxx1200
- BXRA-xxx2000
- BXRA-40E0950
- BXRA-40E1350
- BXRA-40E2200
- BXRA-xxC1100
- BXRA-xxC1600
- BXRA-xxC2600

##### Mounting

- With Zhaga Book 3 LED holder
- BJB spotlight connector 47.319.2040
- Mounting with 2 self tapping screws M3 x 6mm
- Green indicator marks

# MechaTronix *in* LED

## ModulED Mega Modular Passive Star LED Cooler ø134mm



### Mounting Options

#### Citizen LED COB



Citizen Electronics Co., Ltd. is a precision electronics manufacturer with headquarters in Fujiyoshida City, Yamanash Japan. Prefecture and a subsidiary of Citizen Holdings Co., Ltd. Citizen Electronics is a leader in LED light sources for electronic devices and high power white LED lamps. The second generation CITILED CLL LED COB modules and the new upcoming generation CLU distinguish themselves through the combination of high lumen per watt performance combined with a perfect light quality control.

#### Mounting indicator marks overview

MechaTronix recommends the use of a high thermal conductive interface between the LED module and the LED cooler. Either thermal grease, a thermal pad or a phase change thermal pad thickness 0.1-0.15mm is recommended. Thermal pads or phase change thermal pads can be pre-applied from MechaTronix.

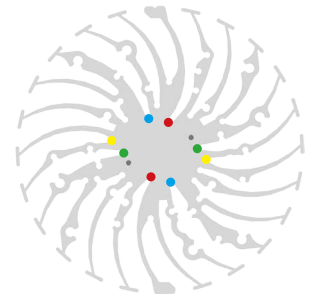

#### Citizen Citiled CLL032 - CLU034



##### Model names

- CLL032-xxxx
- CLU034-xxxx

##### Mounting

- Direct mounting with 2 self tapping screws M3 x 6mm  
Red indicator marks
- With Zhaga Book 3 LED holder  
TE Connectivity Lumawise type Z50 2213254-1  
TE Connectivity Lumawise type Z50 2213254-2  
BJB spotlight connector 47.319.2020  
Mounting with 2 self tapping screws M3 x 6mm  
Green indicator marks

#### Citizen Citiled CLL042 - CLU044

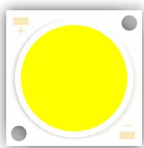

##### Model names

- CLL042-xxxx
- CLU044-xxxx

##### Mounting

- Direct mounting with 2 self tapping screws M3 x 6mm  
Blue indicator marks
- With Zhaga Book 3 LED holder  
BJB spotlight connector 47.319.2030  
Mounting with 2 self tapping screws M3 x 6mm  
Green indicator marks

#### Citizen Citiled CLL052 - CLU054



##### Model names

- CLL052-xxxx
- CLU054-xxxx

##### Mounting

- Direct mounting with 2 self tapping screws M3 x 6mm  
Yellow indicator marks

# MechaTronix *in* LED

## ModulED Mega Modular Passive Star LED Cooler ø134mm



### Mounting Options

#### Cree XLamp LED Array



Cree XLamp® LEDs deliver the industry's best lighting-class performance and are application-optimized to enable the lowest system cost.

Cree's new CXA LED Arrays deliver high lumen output and efficacy in a family of single, easy-to-use components. Optimized to simplify designs and lower system cost, Cree's CXA LED arrays are available in system level performance from 300 to over 16,000 lumens and can enable applications ranging from GU10s and commercial downlights to outdoor area lighting and high-bay lighting.

#### Mounting indicator marks overview

MechaTronix recommends the use of a high thermal conductive interface between the LED module and the LED cooler. Either thermal grease, a thermal pad or a phase change thermal pad thickness 0.1-0.15mm is recommended. Thermal pads or phase change thermal pads can be pre-applied from MechaTronix.

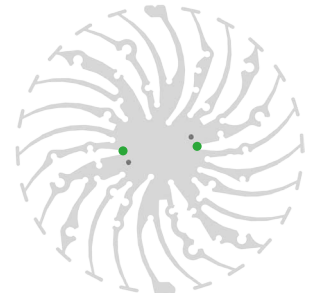

#### Cree XLamp CXA18 LED Array



##### Model names

- CXA1816->xxxx
- CXA1820->xxxx
- CXA1830->xxxx
- CXA1850->xxxx

##### Mounting

- With Zhaga Book 3 LED holder
- BJB Spotlight connector 47.319.2130
- TE Connectivity Lumawise type Z50 2213401-1
- TE Connectivity Lumawise type Z50 2213401-2
- Mounting with 2 self tapping screws M3 x 10mm
- Green indicator marks

#### Cree XLamp CXA25 LED Array



##### Model names

- CXA2520->xxxx
- CXA2530->xxxx
- CXA2540->xxxx
- CXA2590->xxxx

##### Mounting

- With Zhaga Book 3 LED holder
- BJB Spotlight connector 47.319.2140
- TE Connectivity Lumawise type Z50 2213407-1
- TE Connectivity Lumawise type Z50 2213407-2
- Mounting with 2 self tapping screws M3 x 10mm
- Green indicator marks

#### Cree XLamp CXA30 LED Array



##### Model names

- CXA3050->xxxx
- CXA3070->xxxx

##### Mounting

- With Zhaga Book 3 LED holder
- BJB Spotlight connector 47.319.2150
- Mounting with 2 self tapping screws M3 x 10mm
- Green indicator marks

# MechaTronix in LED

## ModulED Mega Modular Passive Star LED Cooler ø134mm



### Mounting Options

### Edison Opto LED Modules and COB's



Edison Opto with headquarters in Chung-Ho Dist, New Taipei City, Taiwan is a professional LED manufacture with specializes in designing and producing High-power LEDs, solid state lighting applications, LED sensors and SPDIFs. In response to rapid growth of capacity demand, Edison Opto has established factories in Dongguan and Yangzhou China and subsidiaries in USA and Germany. Edison Opto COB LED modules outstand in light quality and are available in the broadest lumen and CRI range available on the market.

#### Mounting indicator marks overview

MechaTronix recommends the use of a high thermal conductive interface between the LED module and the LED cooler. Either thermal grease, a thermal pad or a phase change thermal pad thickness 0.1-0.15mm is recommended. Thermal pads or phase change thermal pads can be pre-applied from MechaTronix.

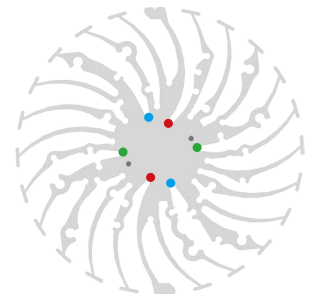

#### Edison Opto Edipower II HM series

##### Model Names 16W - 30W

- 2PHM16xxxx
- 2PHM30xxxx

##### Mounting

- Direct mounting with 2 self tapping screws M3 x 6mm  
Red indicator marks
- With Zhaga Book 3 LED holder  
BJB Spotlight connector 47.319.2020  
TE Connectivity Lumawise type Z50 2213254-1  
TE Connectivity Lumawise type Z50 2213254-2  
Mounting with 2 self tapping screws M3 x 6mm  
Green indicator marks

##### Model Names 40W

- 2PHM40xxxx

##### Mounting

- Direct mounting with 2 self tapping screws M3 x 6mm  
Blue indicator marks
- With Zhaga Book 3 LED holder  
BJB spotlight connector 47.319.2030  
Mounting with 2 self tapping screws M3 x 6mm  
Green indicator marks

#### Edison Opto EdiLex Spot Light Module (SLM)

##### Model Names

- 5PHR11xxxx
- 5PHR22xxxx
- 5PHV35xxxx

##### Mounting

- Direct mounting with 2 self tapping screws M3 x 10mm  
Green indicator marks

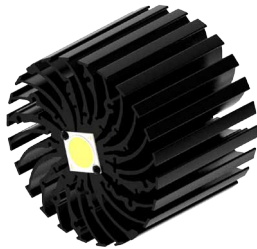

# MechaTronix in LED

## ModuLED Mega Modular Passive Star LED Cooler ø134mm



### Mounting Options

#### GE Lighting LED Modules



GE Infusion™ is a game-changing technology and one of the most flexible LED lighting solutions on the market. As a designer, OEM or end-users, you can choose from an extensive selection of modules. Plus, there's the assurance of GE reliability and performance.

#### Mounting indicator marks overview

MechaTronix recommends the use of a high thermal conductive interface between the LED module and the LED cooler. Either thermal grease, a thermal pad or a phase change thermal pad thickness 0.1-0.15mm is recommended. Thermal pads or phase change thermal pads can be pre-applied from MechaTronix.

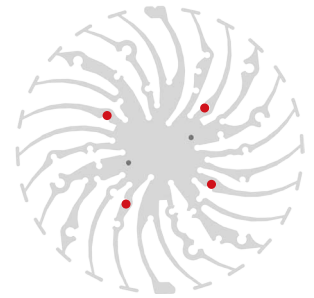

#### Infusion M-series Spot Light Modules

##### Model names

- Infusion M3000 series
- Infusion M4500 series

##### Mounting

- Twist and lock LED engine
- Mounting with GE LED collar by 4 self tapping screws M4 x 6mm or 8mm
- Red indicator marks



#### Infusion DLM-series Down Light Modules

##### Model names

- Infusion DLM3000 series
- Infusion DLM4000 series

##### Mounting

- Twist and lock LED engine
- Mounting with GE LED collar by 4 self tapping screws M4 x 6mm or 8mm
- Red indicator marks



#### Infusion NPM-series Narrow Punch Modules

##### Model names

- MP30/827/W/N
- MP30/830/W/N
- MP30/930/W/N
- MP30/840/W/N

##### Mounting

- Twist and lock LED engine
- Mounting with GE LED collar by 4 self tapping screws M4 x 6mm or 8mm
- Red indicator marks

# MechaTronix *in* LED

## ModulED Mega Modular Passive Star LED Cooler ø134mm



### Mounting Options

#### LG Innotek LED COB



LG Innotek is a global specialized material and component manufacturer who is making a better world through cutting edge core component technology that is leading the market and opening a smarter future through the development of new eco-friendly materials. With the world's highest production capacity as a single-factory and a solid LED business base built over more than a decade, LG Innotek's Paju LED factory produces 2 billion chips a month. Their LEMWM COB LED modules deliver a perfect lumen per watt ratio in an uncompromised lighting quality.

#### Mounting indicator marks overview

MechaTronix recommends the use of a high thermal conductive interface between the LED module and the LED cooler. Either thermal grease, a thermal pad or a phase change thermal pad thickness 0.1-0.15mm is recommended. Thermal pads or phase change thermal pads can be pre-applied from MechaTronix.

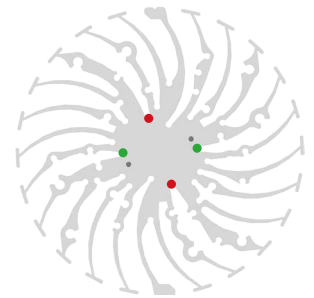

#### LG LEMWM18 17W/24W COB

##### Model names

- LEMWM18780xxxx
- LEMWM18880xxxx

##### Mounting

- With Zhaga Book 3 LED holder
- BJB Spotlight connector 47.319.2080
- Mounting with 2 self tapping screws M3 x 8mm
- Green indicator marks



#### LG LEMWM28 COB

##### Model names

- LEMWM28xxxx

##### Mounting

- Direct mounting with 2 self tapping screws M3 x 6mm
- Red indicator marks
- With Zhaga Book 3 LED holder
- BJB Spotlight connector 47.319.2030
- Mounting with 2 self tapping screws M3 x 8mm
- Green indicator marks



# MechaTronix in LED

## ModulED Mega Modular Passive Star LED Cooler ø134mm



### Mounting Options

#### Lustrous LED COB

### LUSTROUS

Green Technology of Lighting

LUSTROUS unique Chip-on-Board (COB) packaging technology of High Power LED leads the core competence of LUSTROUS. COB packaging technology shows excellent thermal management and high efficiency performance. One of the benefits of COB is bright, uniform light output. The excellent low thermal resistance is achieved through state of the art COB technology on highly conductive substrates. This enables low junction temperatures at chip level for much higher efficiencies.

#### Mounting indicator marks overview

MechaTronix recommends the use of a high thermal conductive interface between the LED module and the LED cooler. Either thermal grease, a thermal pad or a phase change thermal pad thickness 0.1-0.15mm is recommended. Thermal pads or phase change thermal pads can be pre-applied from MechaTronix.

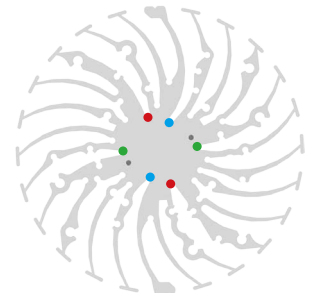

#### Lustrous Lustron LL613F - LL620F LED COB

##### Model names

- Lustron LL613F1206-xxx
- Lustron LL620F1208-xxx

##### Mounting

- Direct mounting with 2 self tapping screws M3 x 6mm
- Red indicator marks
- With Zhaga Book 3 LED holder
- BJB spotlight connector 47.319.2020
- Mounting with 2 self tapping screws M3 x 8mm
- Green indicator marks

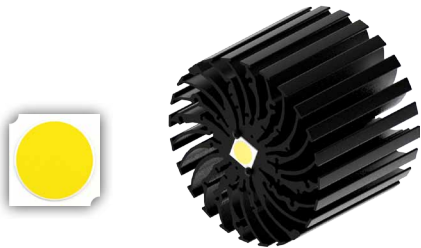

#### Lustrous Lustron LL660D LED COB

##### Model names

- Lustron LL660D1210-xxx

##### Mounting

- Direct mounting with 2 self tapping screws M3 x 6mm
- Blue indicator marks
- With Zhaga Book 3 LED holder
- BJB spotlight connector 47.319.2030
- Mounting with 2 self tapping screws M3 x 8mm
- Green indicator marks

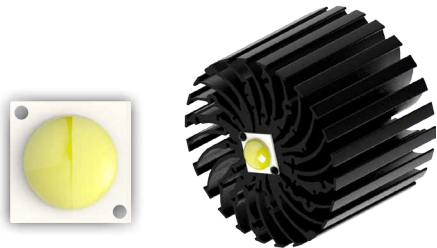

# MechaTronix in LED

## ModuLED Mega Modular Passive Star LED Cooler ø134mm



### Mounting Options

#### Osram PrevaLED LED Modules



With the PrevaLED Core and PrevaLED Core AC, Osram leads the path of versatile LED light modules interchangeable according Zhaga book 3 specifications. With an initial color binning below 3 steps Mc Adam, a wide range of lumen packages from 1.100lm all the way up to 5.000lm and a broad availability of color temperatures, the Osram PrevaLED Core found it's strive in high-end shop and down light applications with an uncompromised lighting quality.

#### Mounting indicator marks overview

MechaTronix recommends the use of a high thermal conductive interface between the LED module and the LED cooler. Either thermal grease, a thermal pad or a phase change thermal pad thickness 0.1-0.15mm is recommended. Thermal pads or phase change thermal pads can be pre-applied from MechaTronix.

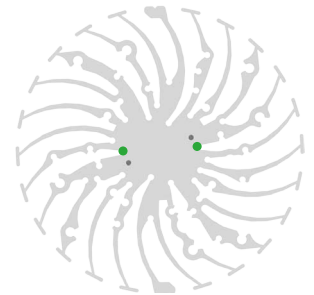

#### Osram PrevaLED Core Z3

##### Model names

- PL-CORE-3000-xxx-Z3
- PL-CORE-5000-xxx-Z3

##### Mounting

- Direct mounting with 2 self tapping screws M3 x 10mm
- Green indicator marks

#### Osram Opto Semiconductors LED COB



Osram SOLERIQ® LEDs are designed to meet the requirements of professional indoor general lighting applications. Large flux output, small light emitting surfaces, variation, CRI greater than 80 and easy to use Chip-on-Board technology support easy and creative lighting design. These properties make SOLERIQ® LED COB modules a high efficient, high-quality and price-performance-optimized solution for all demanding and at the same time cost-conscious lighting manufactures and designers.

#### Mounting indicator marks overview

MechaTronix recommends the use of a high thermal conductive interface between the LED module and the LED cooler. Either thermal grease, a thermal pad or a phase change thermal pad thickness 0.1-0.15mm is recommended. Thermal pads or phase change thermal pads can be pre-applied from MechaTronix.

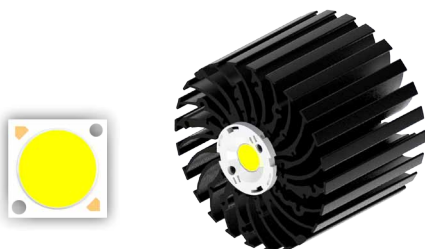
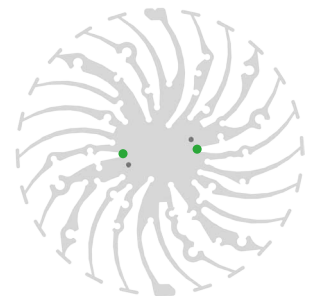

#### Osram Soleriq S19 LED COB

##### Model names

- GW-KAHLB1-xxxx

##### Mounting

- With Zhaga Book 3 LED holder
- BJB spotlight connector 47.319.2170
- TE Connectivity Lumawise type Z50 2213407-1
- TE Connectivity Lumawise type Z50 2213407-2
- Mounting with 2 self tapping screws M3 x 8mm
- Green indicator marks

# MechaTronix in LED

## ModulED Mega Modular Passive Star LED Cooler ø134mm



### Mounting Options

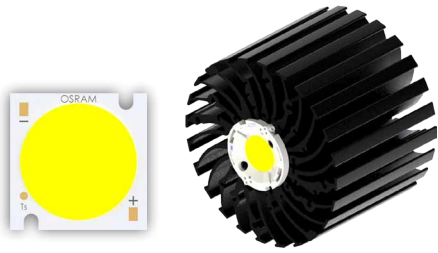

#### Osram Soleriq E30 LED COB

##### Model names

- GW KAJRB2.EM-STTQ->xxxx
- GW KAJRB2.EM-TPTR->xxxx

##### Mounting

- With Zhaga Book 3 LED holder
- BJB spotlight connector 47.319.2090
- Mounting with 2 self tapping screws M3 x 8mm
- Green indicator marks

### Philips LED Modules

# PHILIPS

The third Philips Fortimo LED SLM generation is the ideal solution for spot lighting fixtures and highly efficient compact down light luminaires. It is specifically designed for the retail market showcasing retail merchandise in bright and vivid light. This generation is equipped with new Chip-On-Board (COB) LED technology. This technology enables the creation of the most efficient point source Philips LED system available.

#### Mounting indicator marks overview

MechaTronix recommends the use of a high thermal conductive interface between the LED module and the LED cooler. Either thermal grease, a thermal pad or a phase change thermal pad thickness 0.1-0.15mm is recommended. Thermal pads or phase change thermal pads can be pre-applied from MechaTronix.

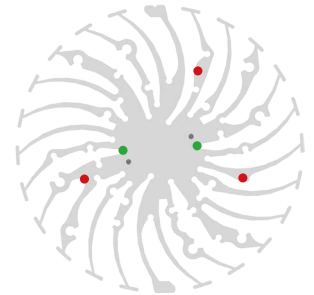

#### Philips Fortimo SLM GEN3 / GEN4 LED Modules

##### Model names

- Fortimo LED SLM 4000 G3
- Fortimo LED SLM 4500 G3
- Fortimo LED SLM 4500 G4

##### Mounting

- Direct mounting with 2 self tapping screws M3 x 6mm
- Green indicator marks



#### Philips Fortimo DLM GEN5 LED Modules

##### Model names

- Fortimo DLM 3000 G5
- Fortimo DLM 5000 G5

##### Mounting

- Direct mounting with 3 self tapping screws M3 x 8mm
- Red indicator marks

# MechaTronix in LED

## ModuLED Mega Modular Passive Star LED Cooler ø134mm



### Mounting Options

### Philips Lumileds LED Array & COB

#### PHILIPS LUMILEDS

Philips Lumileds LUXEON COB is a new breakthrough in efficacy for arrays. Due to its industry leading small Light Emitting Surfaces (LES), the COB array is very easy work with and will enable easier and less expensive designs. All LUXEON COBs are available in a single 3-step as well as a single 5-step MacAdam Ellipse, ensuring uniform optical performance in the application. Ideal applications include down lights and directional lamps.

#### Mounting indicator marks overview

MechaTronix recommends the use of a high thermal conductive interface between the LED module and the LED cooler. Either thermal grease, a thermal pad or a phase change thermal pad thickness 0.1-0.15mm is recommended. Thermal pads or phase change thermal pads can be pre-applied from MechaTronix.

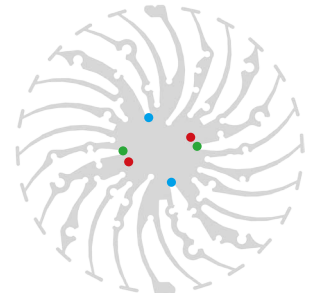

#### Luxeon COB 1205 - 1208

##### Model names

- Luxeon COB LHC1-xxxx-1205
- Luxeon COB LHC1-xxxx-1208

##### Mounting

- Direct mounting with 2 self tapping screws M3 x 6mm  
Red indicator marks
- With Zhaga Book 3 LED holder  
BJB spotlight connector 47.319.2010  
TE Connectivity Lumawise type Z50 2213130-1  
TE Connectivity Lumawise type Z50 2213130-2  
Mounting with 2 self tapping screws M3 x 8mm  
Green indicator marks



#### Luxeon COB 1211

##### Model names

- Luxeon COB LHC1-xxxx-1211

##### Mounting

- Direct mounting with 2 self tapping screws M3 x 6mm  
Blue indicator marks
- With Zhaga Book 3 LED holder  
BJB spotlight connector 47.319.2030  
Mounting with 2 self tapping screws M3 x 8mm  
Green indicator marks

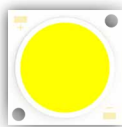

# MechaTronix in LED

## ModulED Mega Modular Passive Star LED Cooler ø134mm



### Mounting Options

#### Prolight Opto LED COB's



Founded in October 2004, Prolight Opto Technology Corporation is a professional manufacturer of LED packaging, dedicated to the research, development, and manufacturing of mid-to-high-power, high reliability LED packages. Prolight Opto continually invests over 6% of sales revenue in R&D and patents. With own package patents from the US and Taiwan they insure a wide range of LED emitters in the smallest foot prints and COB LED modules with perfect thermal management and high density lumen output.

#### Mounting indicator marks overview

MechaTronix recommends the use of a high thermal conductive interface between the LED module and the LED cooler. Either thermal grease, a thermal pad or a phase change thermal pad thickness 0.1-0.15mm is recommended. Thermal pads or phase change thermal pads can be pre-applied from MechaTronix.

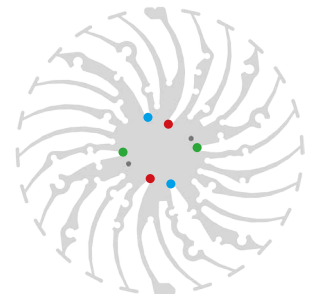

#### Prolight Opto CII series PACC COB

##### Model names

- PACC-18xxx-xxxx

##### Mounting

- Direct mounting with 2 self tapping screws M3 x 6mm  
Red indicator marks
- With Zhaga Book 3 LED holder  
BJB Spotlight connector 47.319.2020  
TE Connectivity Lumawise type Z50 2213254-1  
TE Connectivity Lumawise type Z50 2213254-2  
Mounting with 2 self tapping screws M3 x 6mm  
Green indicator marks



#### Prolight Opto CIII series PACD COB

##### Model names

- PACD-40xxx-xxxx

##### Mounting

- Direct mounting with 2 self tapping screws M3 x 6mm  
Blue indicator marks
- With Zhaga Book 3 LED holder  
BJB spotlight connector 47.319.2030  
Mounting with 2 self tapping screws M3 x 6mm  
Green indicator marks



# MechaTronix in LED

## ModuLED Mega Modular Passive Star LED Cooler ø134mm



### Mounting Options

#### Seoul Semiconductor LED COB



SEOUL SEMICONDUCTOR

The new Seoul Semiconductor ZC series Chip-On-Board (COB) LED Arrays offer high lumen density and efficacies of up to 140lm/W in a single, easy-to-use LED component family. Available in all major color temperatures from 2700K up to 6000K, these high flux packages deliver system level performance of 700 lumens to over 6,000 lumens. The new ZC series family is available in a single 3-step MacAdam Ellipse binning, ensuring excellent color consistency with minimum CRI options of 70, and 80 combining high quality of light with high efficacy.

#### Mounting indicator marks overview

MechaTronix recommends the use of a high thermal conductive interface between the LED module and the LED cooler. Either thermal grease, a thermal pad or a phase change thermal pad thickness 0.1-0.15mm is recommended. Thermal pads or phase change thermal pads can be pre-applied from MechaTronix.

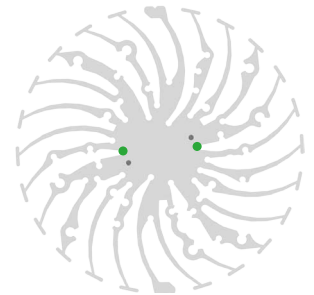

#### Seoul Semiconductor ZC 40 LED COB

##### Model names

- SDW05F1C
- SDW85F1C
- SDW95F1C

##### Mounting

- With Zhaga Book 3 LED holder
- BJB spotlight connector 47.319.2030
- Mounting with 2 self tapping screws M3 x 6mm
- Green indicator marks

#### Tridonic LED Modules and COB



With the TALEXX LED products Tridonic gives you the confidence that your chosen lighting solution will give you precisely the results you want. Thanks to Tridonic's many years of experience in product development they have been able to raise the quality of light from their LEDs to new levels. The production series have an exceptionally constant light color so they guarantee a uniform and crystal clear color appearance. In addition to high efficiency and balanced distribution of light Tridonic offers you impressive robustness in the latest generation of their products and the resultant long life will save you maintenance and repair costs.

#### Mounting indicator marks overview

MechaTronix recommends the use of a high thermal conductive interface between the LED module and the LED cooler. Either thermal grease, a thermal pad or a phase change thermal pad thickness 0.1-0.15mm is recommended. Thermal pads or phase change thermal pads can be pre-applied from MechaTronix.

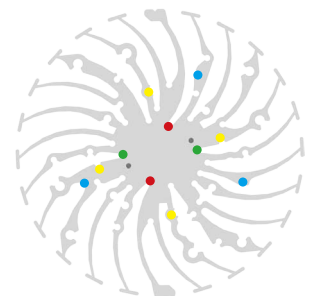

#### Tridonic Talexx Stark SLE GEN3 SELECT / CLASSIC / FOOD / ART

##### Model names

- STARK-SLE-G3-19-xxx
- STARK-SLE-G3-23-xxx

##### Mounting

- Direct mounting with 2 self tapping screws M3 x 8mm
- Green indicator marks

# MechaTronix in LED

## ModuLED Mega Modular Passive Star LED Cooler ø134mm



### Mounting Options

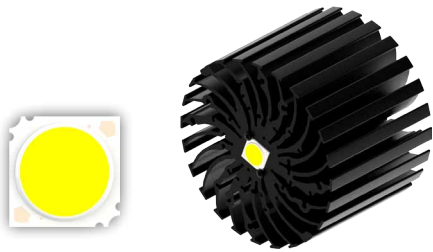

#### Tridonic Talexx Stark SLE GEN3 Mini LES-17 SELECT / CLASSIC

##### Model names

- STARK-SLE-PURE-G3-17-xxx

##### Mounting

- Direct mounting with 2 self tapping screws M3 x 8mm  
Red indicator marks
- With Zhaga Book 3 LED holder  
BJB Spotlight connector 47.319.2020  
Mounting with 2 self tapping screws M3 x 8mm  
Green indicator marks



#### Tridonic Talexx Stark SLE GEN4 ADVANCE / EXCITE / ESSENCE

##### Model names

- STARK-SLE-G4-19mm-3000lm-xxx
- STARK-SLE-G4-23mm-5000lm-xxx
- STARK-SLE-G4-23-5000-xxx-PURE W/O-C

##### Mounting

- Direct mounting with 2 self tapping screws M3 x 8mm  
Green indicator marks



#### Talexx Stark DLE GEN2 CLASSIC / integrated Advanced

##### Model names

- STARK-DLE-G2-LES65-xxxx
- STARK-DLE-PURE-G2-LES65-xxxx

##### Mounting

- Direct mounting with 3 self tapping screws M3 x 8mm  
Blue indicator marks

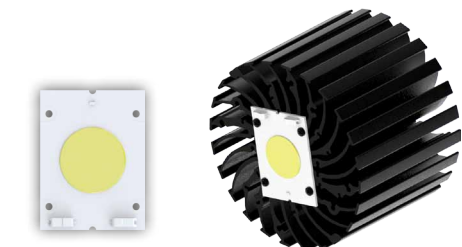

#### Talexx Stark FLE GEN1

##### Model names

- STARK-FLE-G1-30-xxx
- STARK-FLE-G1-40-xxx

##### Mounting

- Direct mounting with 4 self tapping screws M3 x 6mm  
Yellow indicator marks

# MechaTronix in LED

## ModuLED Mega Modular Passive Star LED Cooler ø134mm



### Mounting Options

### Vossloh Schwabe LED Modules



Vossloh-Schwabe is an independent brand within the Panasonic Group responsible for the global development of the business area "Components for light technology". Panasonic employs 367,000 members of staff with an annual turnover of 76.75 billion Euros (8692.7 billion yen) and is represented throughout the world by more than 634 companies or representations in Asia, America and Europe. The Vossloh Schwabe Luga Shop LED modules are ideal solution for high-end luminaire designs where quality stands at the first place.

#### Mounting indicator marks overview

MechaTronix recommends the use of a high thermal conductive interface between the LED module and the LED cooler. Either thermal grease, a thermal pad or a phase change thermal pad thickness 0.1-0.15mm is recommended. Thermal pads or phase change thermal pads can be pre-applied from MechaTronix.

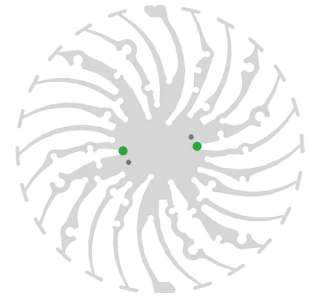

#### Luga Shop 2014 LED modules

##### Model names

- WU-M-484 / WU-M-461
- WU-M-485 / WU-M-462
- WU-M-486 / WU-M-464

##### Mounting

- Direct mounting with 2 self tapping screws M3 x 10mm
- Green indicator marks



#### Luga Shop 2014 Kit LED COB

##### Model names

- DMS128
- DMS158

##### Mounting

- With Luga Shop Kit holder
- Mounting with 2 self tapping screws M3 x 6mm
- Green indicator marks

# MechaTronix in LED

## ModuLED Mega Modular Passive Star LED Cooler ø134mm



### Drawings & Dimensions

### Example: ModuLED Mega 134100

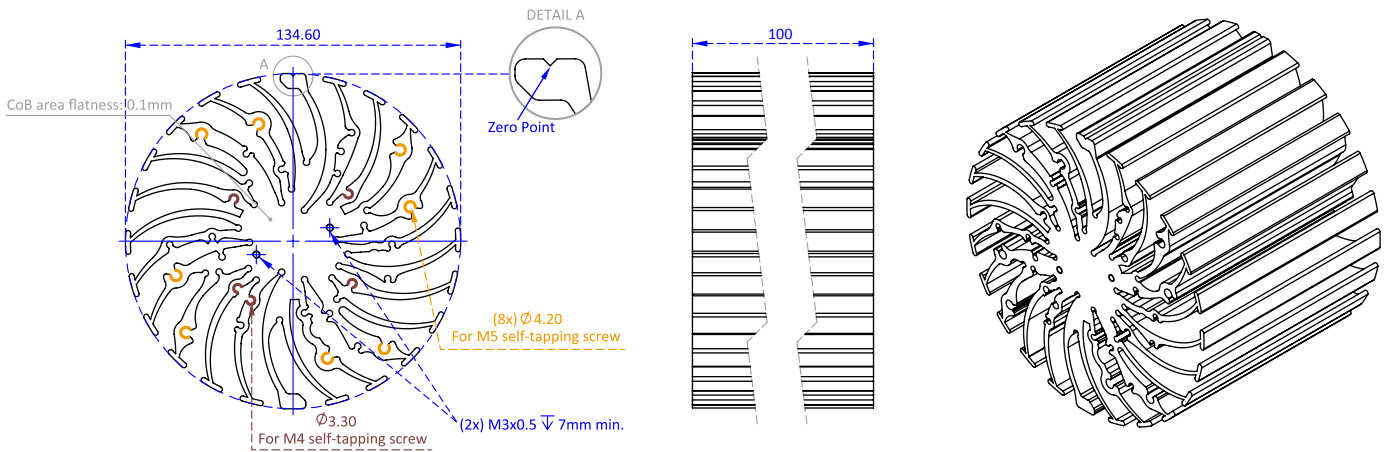

### Thermal Data

$P_d = P_e \times (1-\eta_L)$	Heat sink to ambient thermal resistance $R_{hs-amb}$ (°C/W)			Heat sink to ambient temperature rise $T_{hs-amb}$ (°C)		
	ModuLED Mega 13420	ModuLED Mega 13450	ModuLED Mega 134100	ModuLED Mega 13420	ModuLED Mega 13450	ModuLED Mega 134100
10	1.70	1.20	-	17	12	-
20	1.45	1.05	0.80	29	21	16
30	1.37	0.97	0.77	41	29	23
40	1.30	0.93	0.73	52	37	29
50	1.26	0.90	0.70	63	45	35
60	1.22	0.87	0.68	73	52	41
70	-	0.84	0.67	-	59	47
80	-	0.83	0.66	-	66	53
90	-	0.81	0.64	-	73	58
100	-	-	0.63	-	-	63

ModuLED Mega performance data at a heat sink to ambient temperature difference,  $\Delta T_{hs-amb}$ , of 50 °C

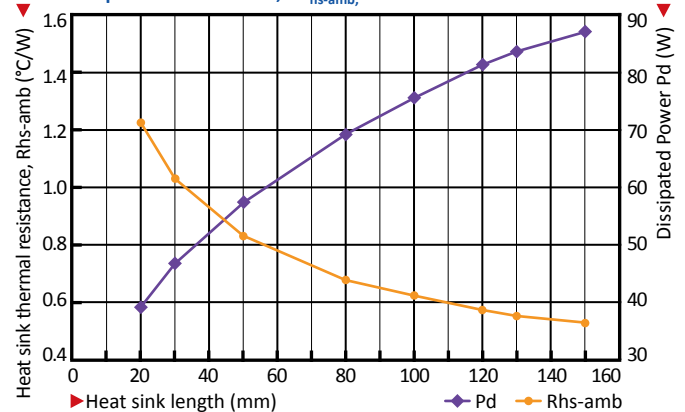

Heat sink to ambient temperature rise  $T_{hs-amb}$  (°C)

ModuLED Mega 13420 ModuLED Mega 13450 ModuLED Mega 134100

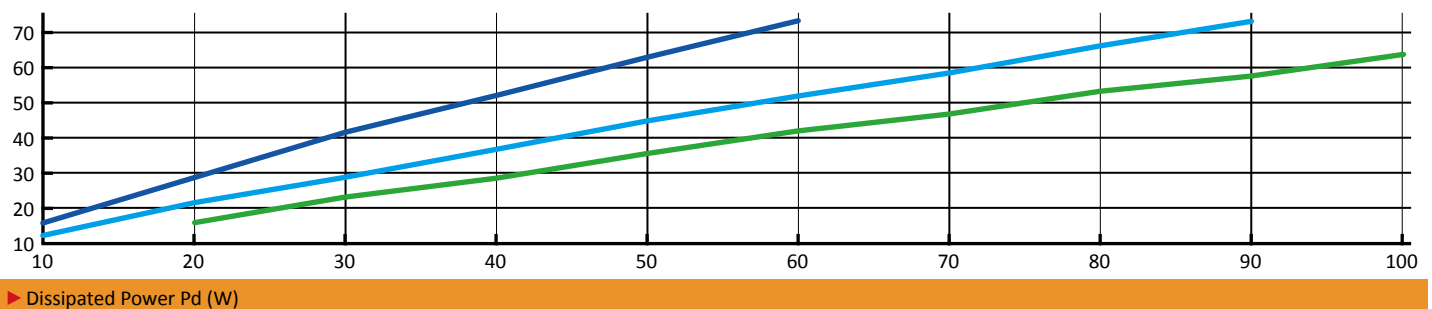

Dissipated Power Pd (W)