

DETAILS

Product Number	FN14720_STELLA-FRESNEL
Family	STELLA
Type	Pack
Color	black
Diameter	90 mm
Height	23 mm
Style	round
Optic Material	Silicone
Holder Material	
Fastening	screw
Status	production ready
ROHS Compliant	Yes
Date Updated	6/09/2016



OPTICAL PROPERTIES

LED	Viewing	Light	Effi-	cd/lm	Connector
	Angle	Beam	ciency		
VERO29	48 deg	Streetligh...	87 %	0.680	-
CLL04x/CLU04x	36 deg	Streetligh...	86 %	1.100	-
CXA/B 3590	sim: 37	Streetligh...	sim: 83 %	sim: 1.100	-
CXA/B 25xx	sim: 24	Streetligh...	sim: 83 %	sim: 2.500	-
CXA/B 30xx	37 deg	Streetligh...	88 %	1.000	BJB: 47.319.2151
LUXEON CoB 1216	39 deg	Streetligh...	86 %	0.930	-
LUXEON CoB 1208	sim: 23	Streetligh...	sim: 82 %	sim: 2.800	-
CXM-22	38 deg	Streetligh...	86 %	0.930	Bender Wirth: 431 Typ L3
Solerial P13	25 deg	Streetligh...	89 %	1.900	-
Solerial S19	32,1 deg	Streetligh...	84 %	1.219	-
Fortimo SLM 1211 L19 G6 Poke-In	33 deg	Streetligh...	87 %	1.200	-
SLE G5 LES19	30 deg	Streetligh...	86 %	1.360	-
SLE G5 LES23	35 deg	Streetligh...	86 %	1.050	-

H G F E D C B A

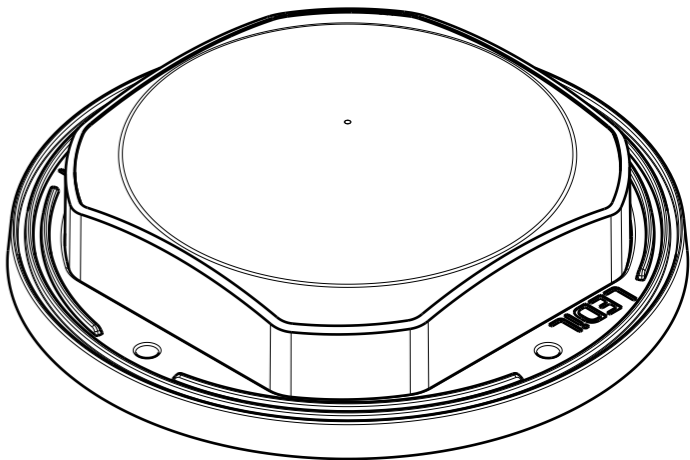
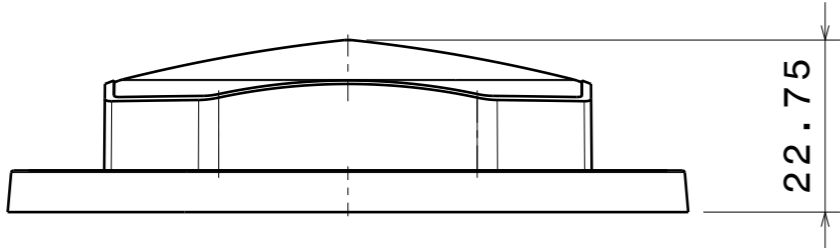

Isometric view
Scale: 1:1

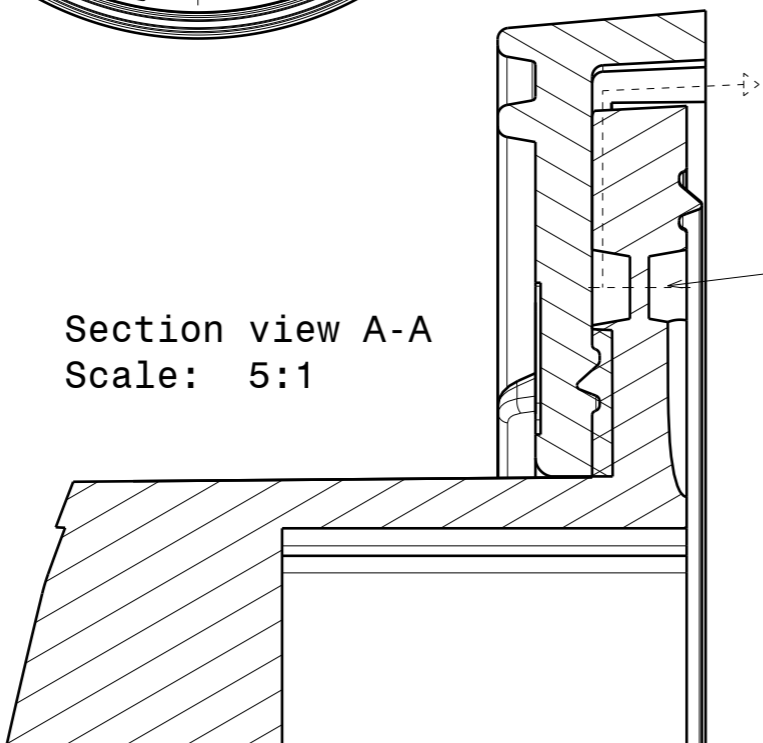
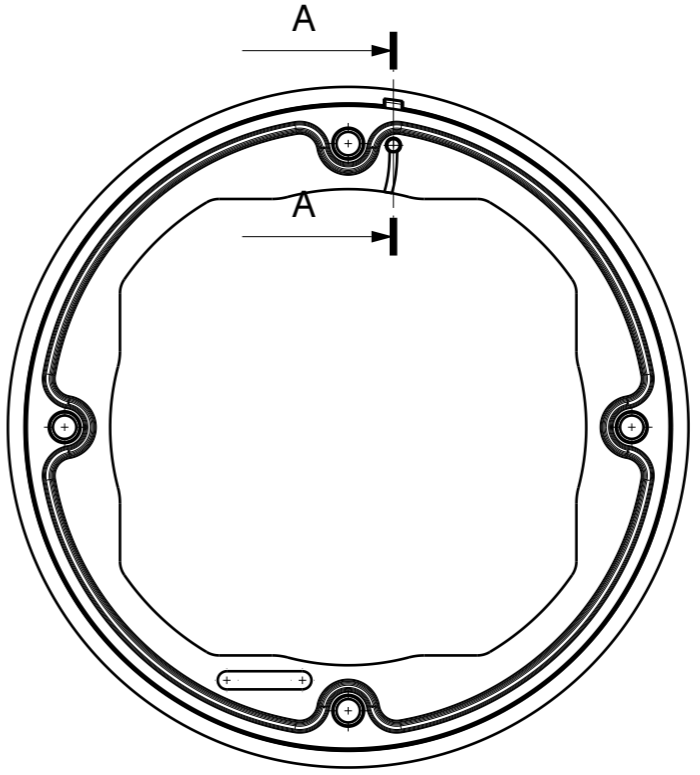
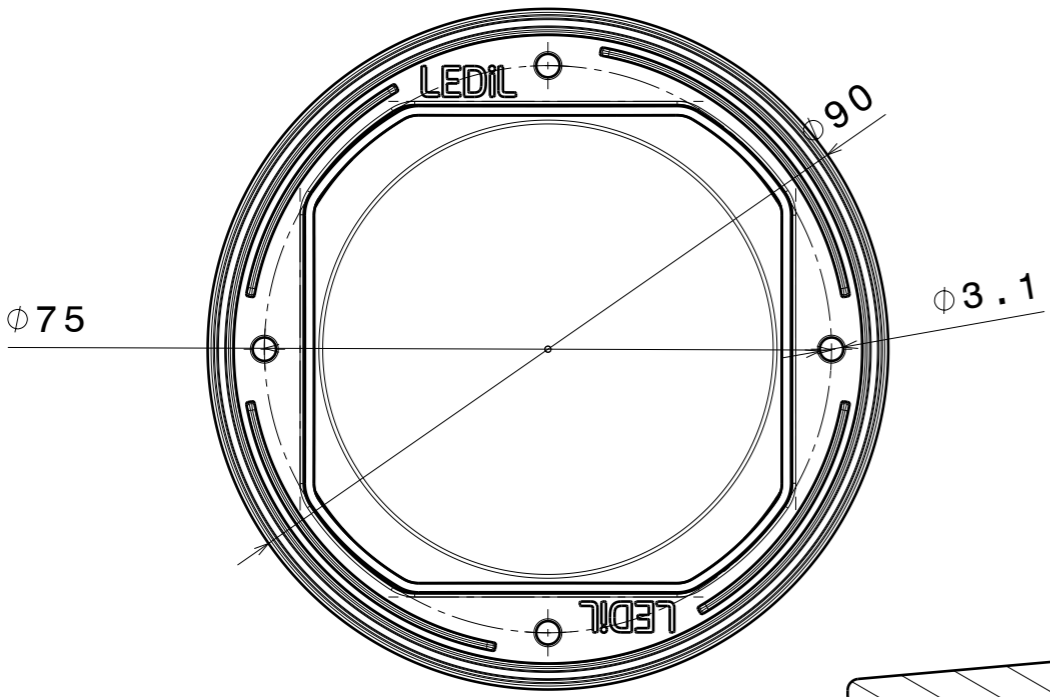

Section view A-A
Scale: 5:1

Venting pipe:
Piercing this membrane
will Allow lens breathing

NOTE: Maximum recommended tightening
torque for STELLA-FRAME is 0,4Nm

INDEX	PART NO	DESCRIPTION	MATERIAL	COLOUR
1	F14627	STELLA-FRESNEL	Optical grade LSR	
	C13322	STELLA-FRAME	PA	black

Tolerances if not otherwise shown
According to DIN ISO 2768-1
Linear measures: class V
Please note that due to the elasticity of
products made of silicone actual measured
values may vary, and therefore typical
tolerance values may not be applied.

LEDiL LediL Oy
Salorankatu 10
FIN 24240 SALO
Finland

THIRD ANGLE PROJECTION:

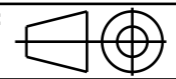

DRAWING TITLE
FN14720_STELLA-FRESNEL

This drawing is the property
of LEDiL Oy. It may not be
reproduced, copied or
communicated without a written
agreement with LEDiL Oy.

SIZE PART NUMBER
A3 FN14720

SCALE 1:1 WEIGHT 34,65 g SHEET 1/1

H G B A

Luminaire: Ledil FN14720_STELLA-FRESNEL_(Vero29)

Lamps: 1 x Bridgelux_Vero29_(30-E10K0L-Y2)_1467.5lm@250mA_P=8.8850W_I=0.25A

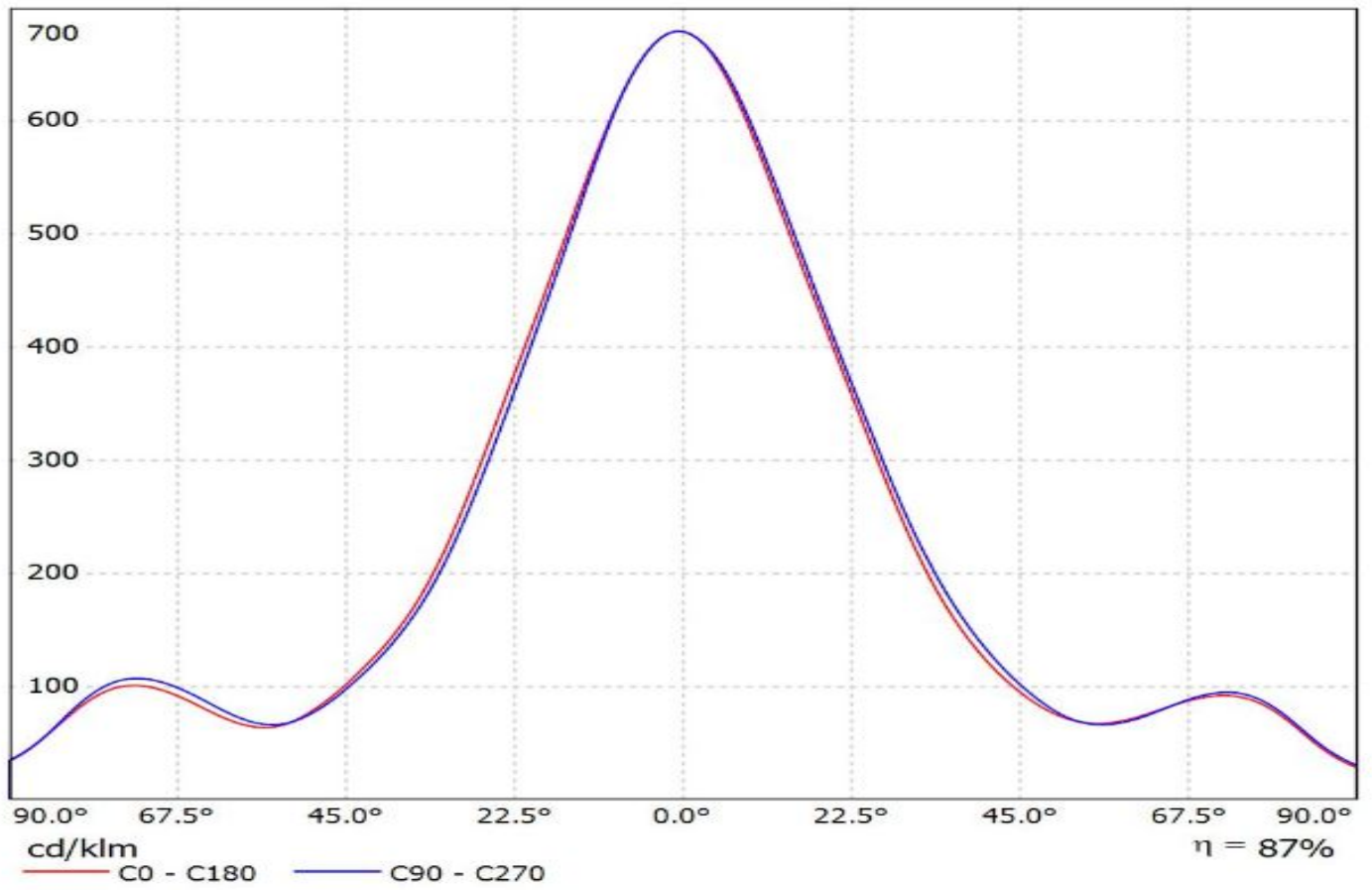

Luminaire: LEDiL Oy FN14720_STELLA-FRESNEL_(CLU046)
Lamps: 1 x Citizen_CLU046_1354.66lm@250mA_P=8.06877W_I=0.2499A

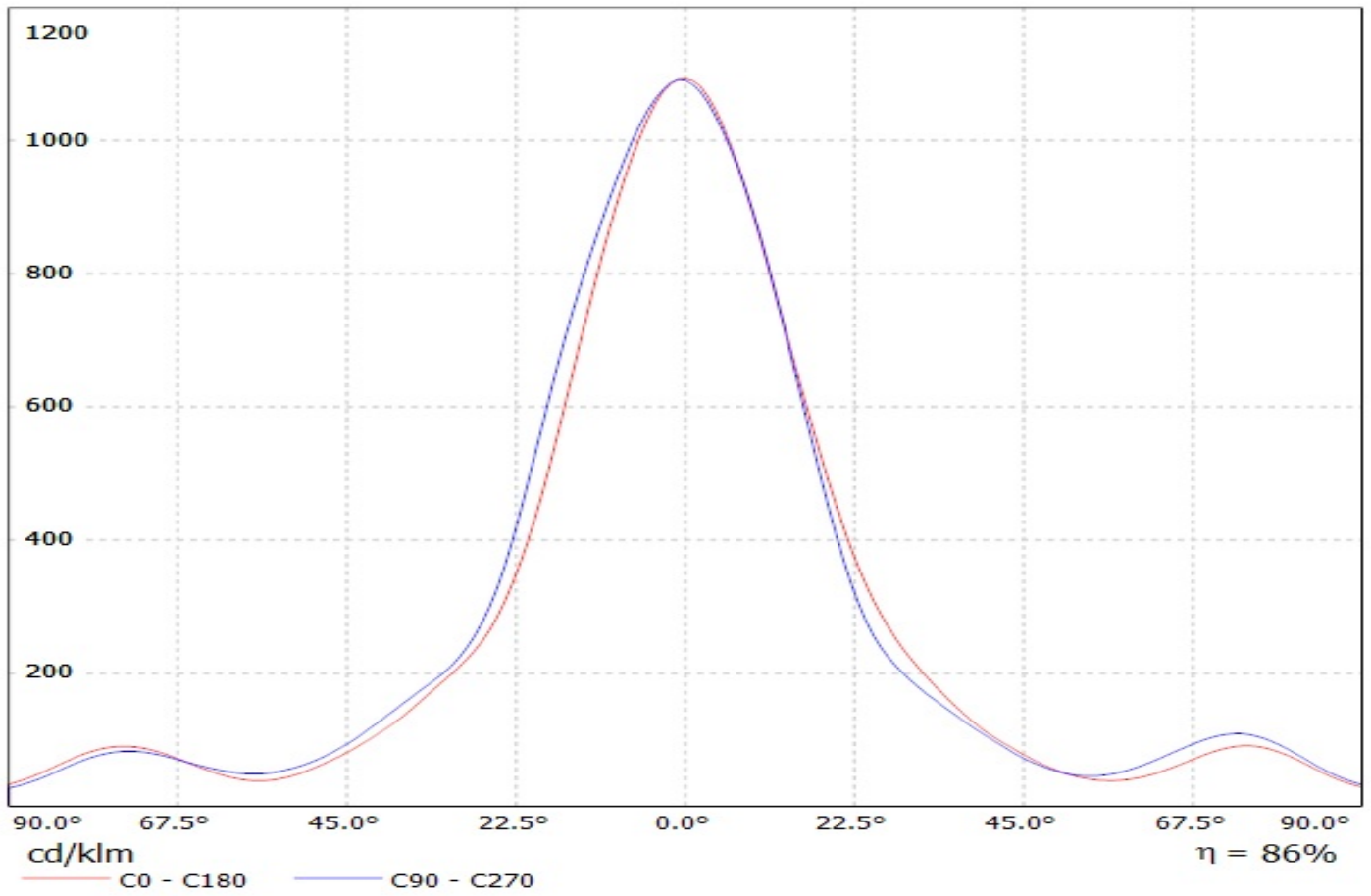

Luminaire: Ledil Oy FN14720_STELLA-FRESNEL_(CXA3590)_SIMULATED
Lamps: 1 x Cree CXA3590

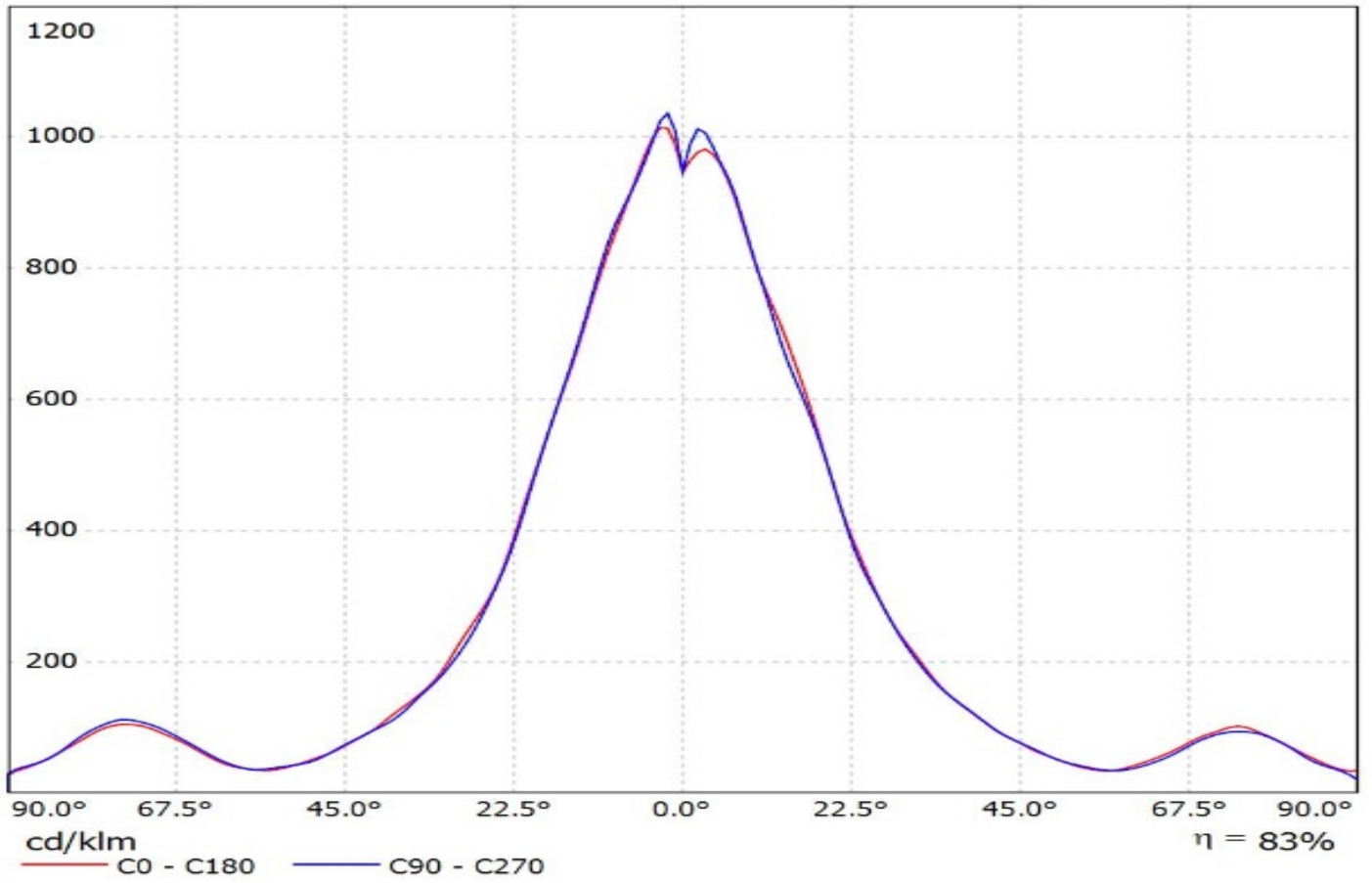

Luminaire: Ledil Oy FN14720_STELLA-FRESNEL_(CXA2590)_SIMULATED
Lamps: 1 x Cree CXA2590

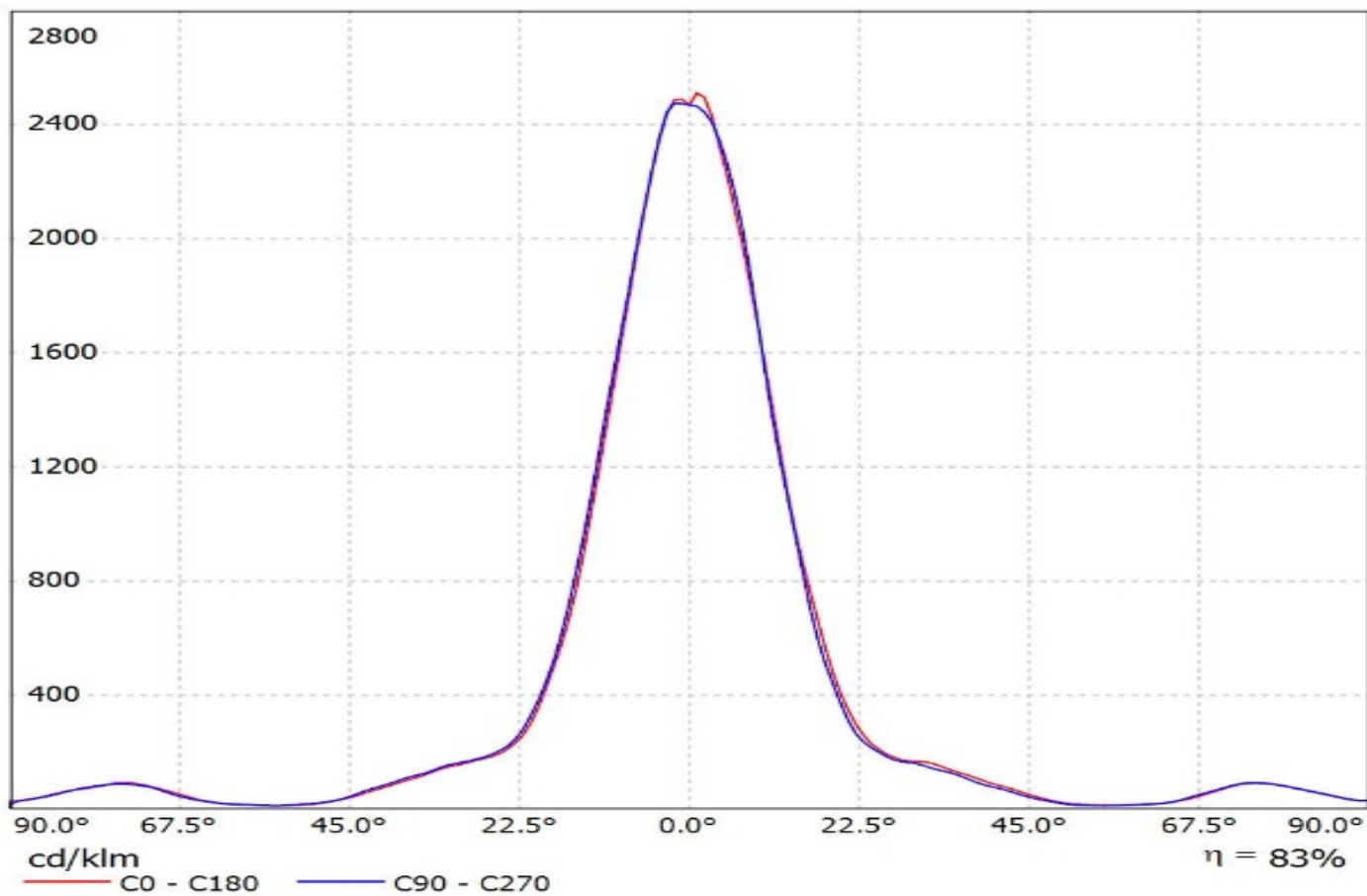

Luminaire: Ledil FN14720_STELLA-FRESNEL (CXB3070 +BJB)

Lamps: 1 x Cree_CXB3070_(-30G-AD-N0H-0001)_+BJB_47.319.2150_1399.52lm@250mA_CCT=3000K_P=8.0355W_I=0.25A

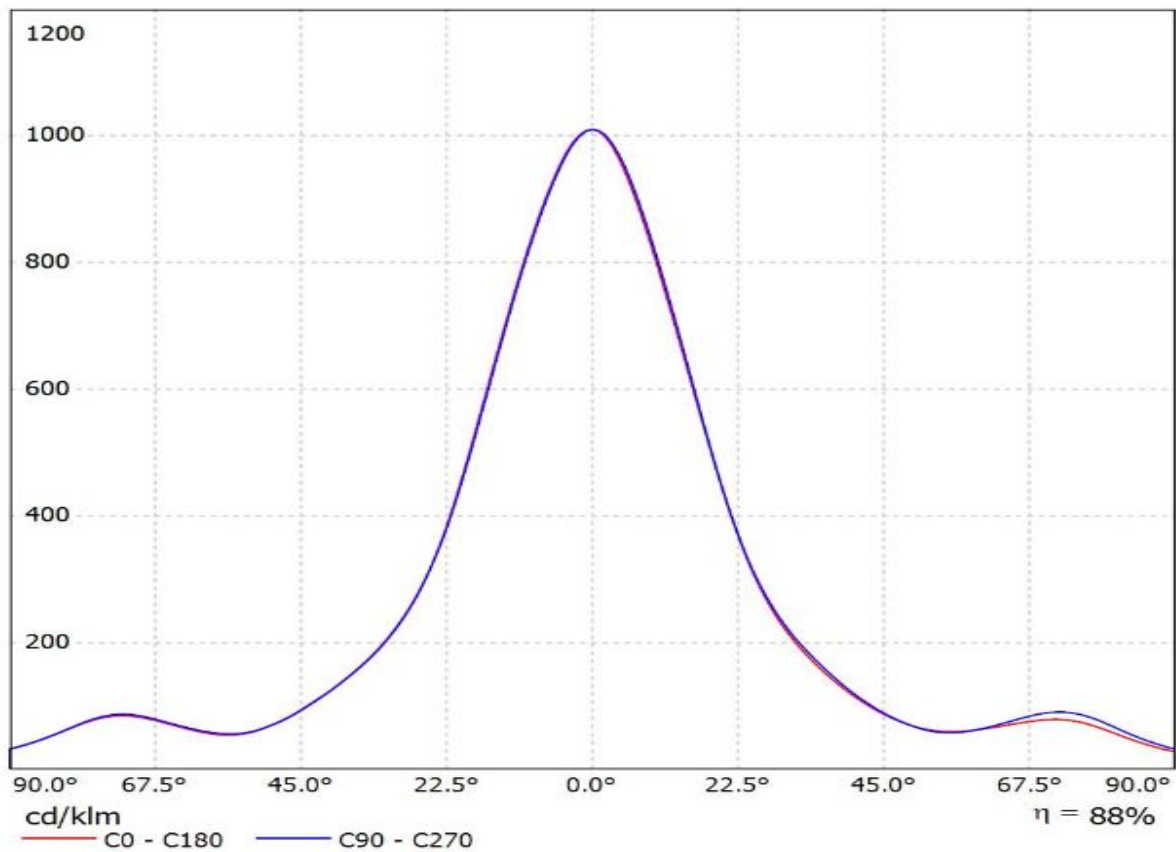

Luminaire: Ledil FN14720_STELLA-FRESNEL_(CoB_1216)

Lamps: 1 x Luxeon_CoB_1216_(L2C2-40801216E2300)_1468.12lm@250mA_P=7.9868W_η=0.25A

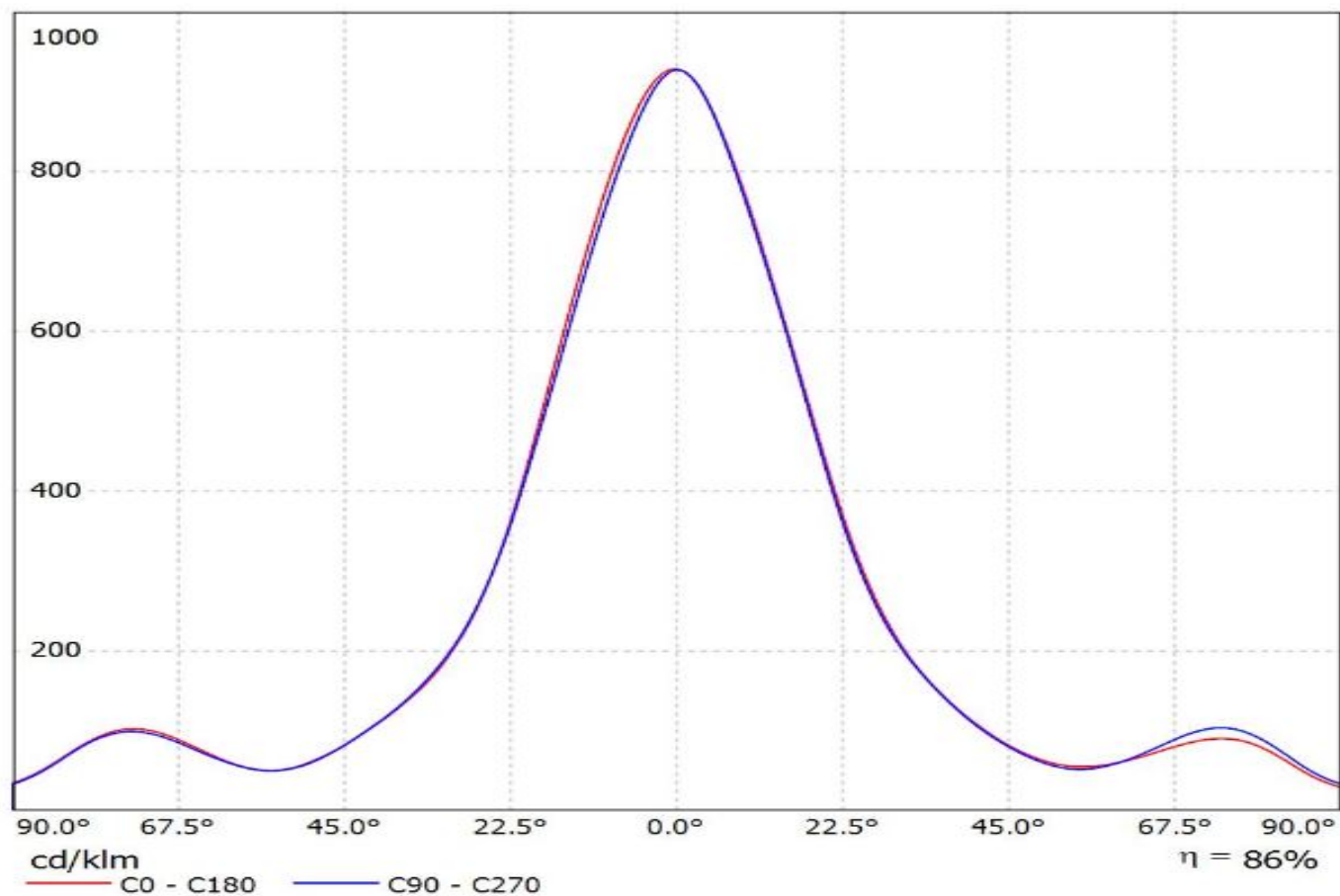

Luminaire: Ledil Oy FN14720_STELLA-FRESNEL_(Luxeon_CoB_1208)_SIMULATED
Lamps: 1 x Lumileds Luxeon CoB 1208

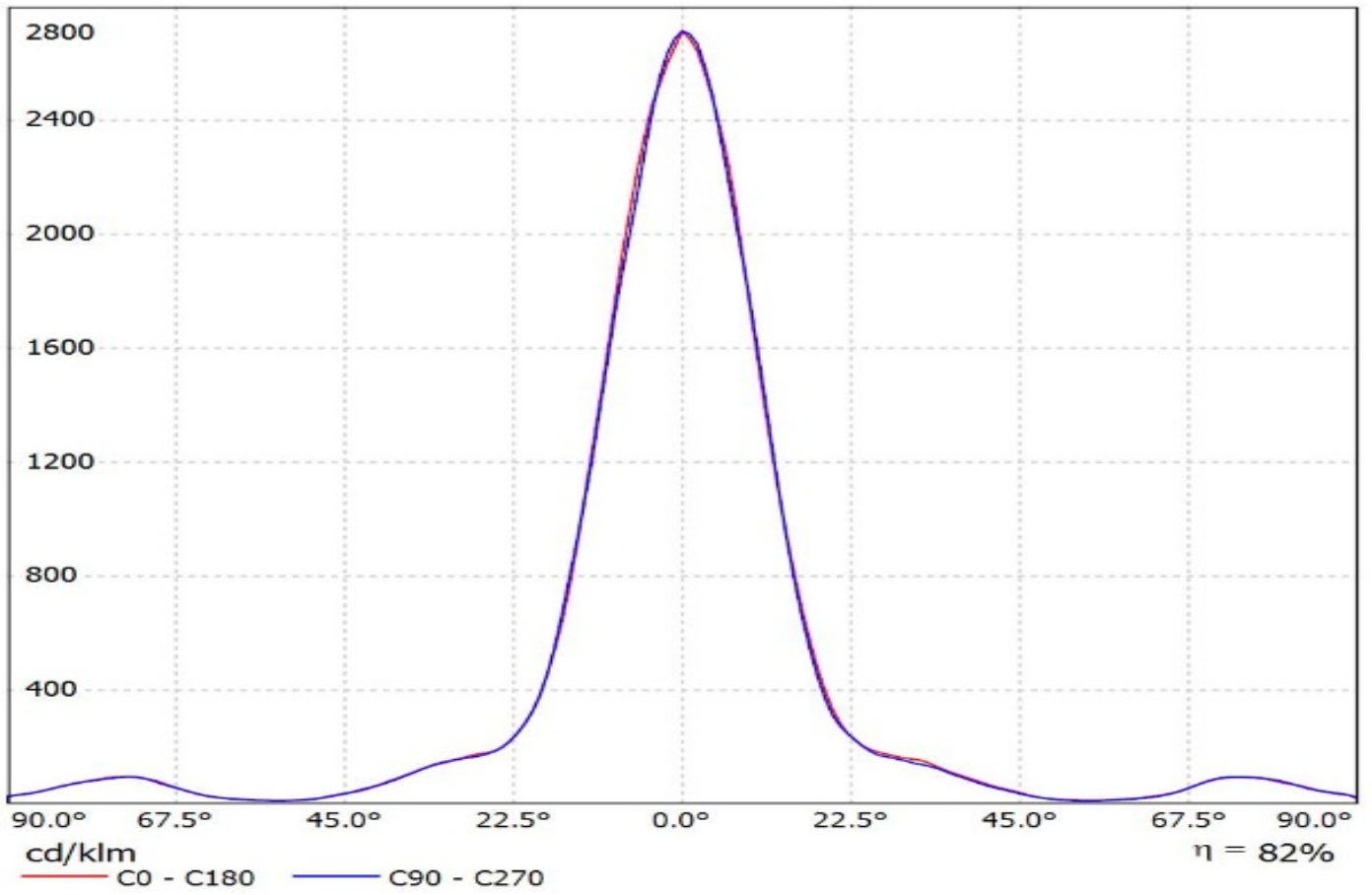

Luminaire: Ledil FN14720_STELLA-FRESNEL_(CXM-22_+BW)
Lamps: 1 x LUMINUS_CXM-22_+Bender&Wirth_431TypL3_1259.61lm@250mA_P=8.0332W_CCT=3000K_I=0.25A

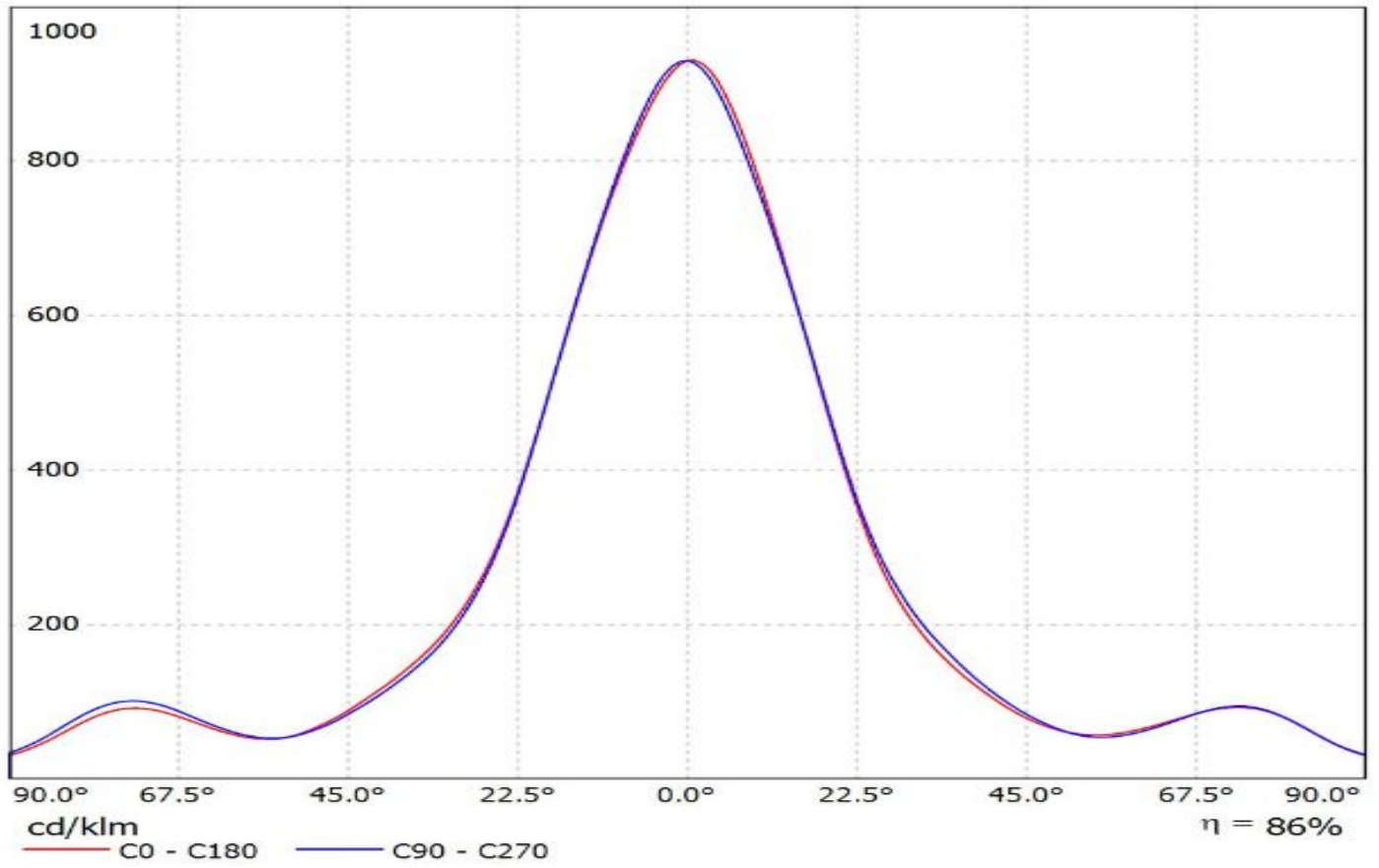

Luminaire: LEDiL Oy FN14720_STELLA-FRESNEL_(Soleriq_P13)_Cav1

Lamps: 1 x Osram_Soleriq_P13_(GQ_MAGMB1.EM)_922.464lm@250mA_P=8.69804W_I=0.2498A

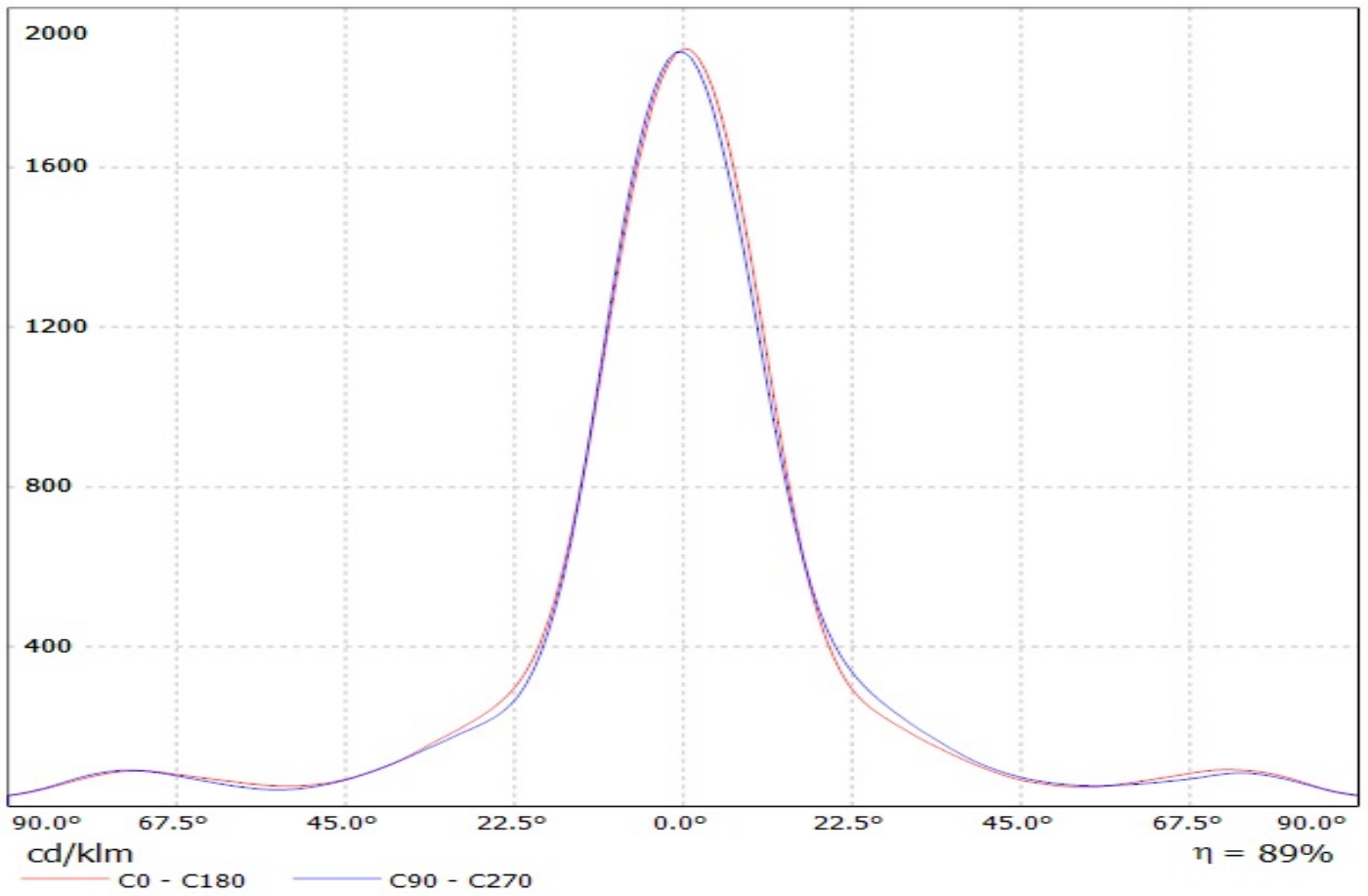

Luminaire: Ledil FN14720_STELLA-FRESNEL_(Soleriq_S19)
Lamps: 1 x Osram_Soleriq_S19_(GW-KAHJB1.EM)_1487.02lm@250mA_P=10.562W_I=0.25A

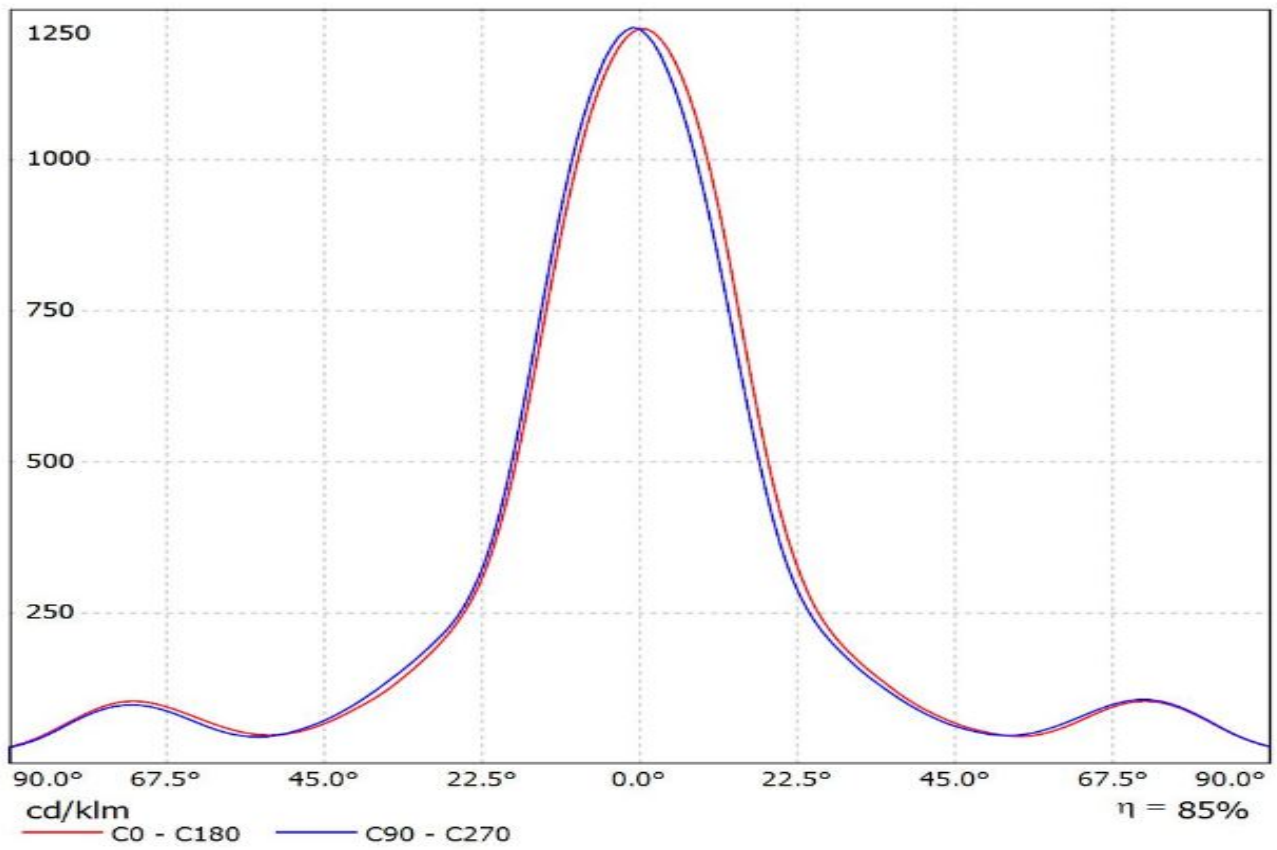

Luminaire: LEDiL Oy FN14720_STELLA-FRESNEL_(SLM_1211_L19_G6)

Lamps: 1 x Philips_Fortimo_SLM_1211_L19_G6_Poke-In_1152.17lm@250mA_P=8.10051W_I=0.25A

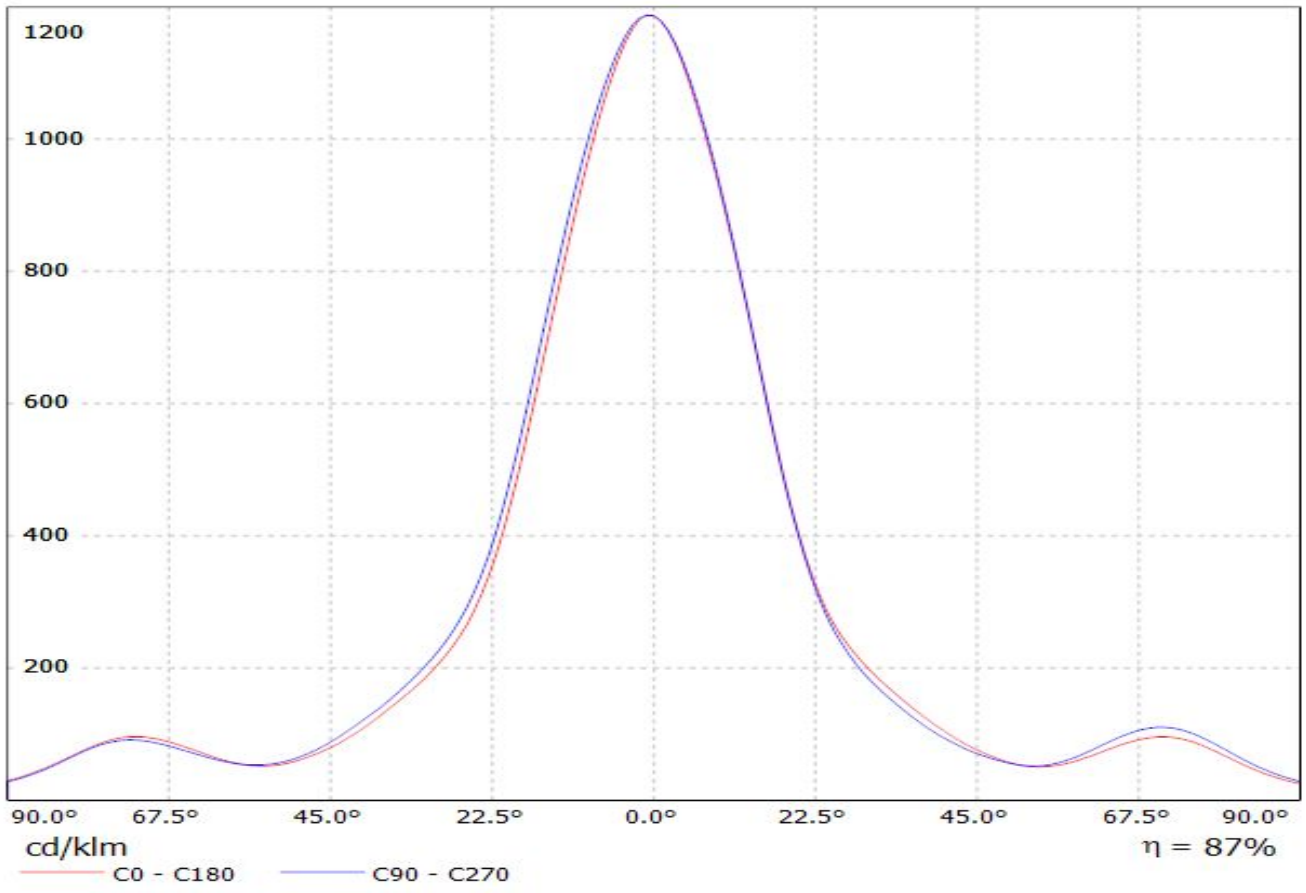

Luminaire: LEDiL Oy FN14720_STELLA-FRESNEL_(SLE-G5_LES-19)
Lamps: 1 x Tridonic_SLE-G5_LES-19_1189.9lm@250mA_P=8.3068W_I=0.250A

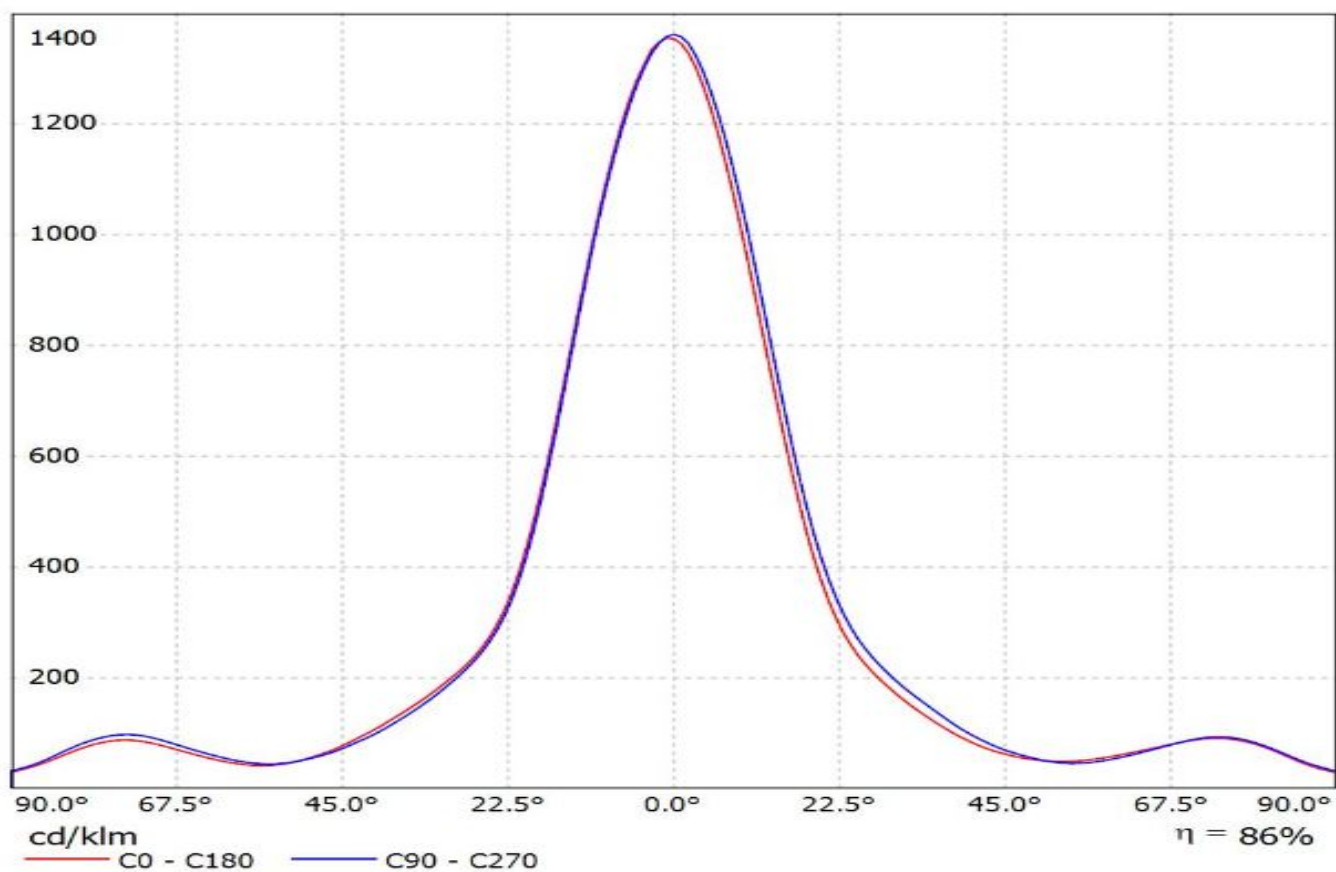

Luminaire: LEDiL Oy FN14720_STELLA-FRESNEL_(SLE-G5_LES-23)
Lamps: 1 x Tridonic_SLE-G5_LES-23_1408.28lm@250mA_P=8.1392W_I=0.250A

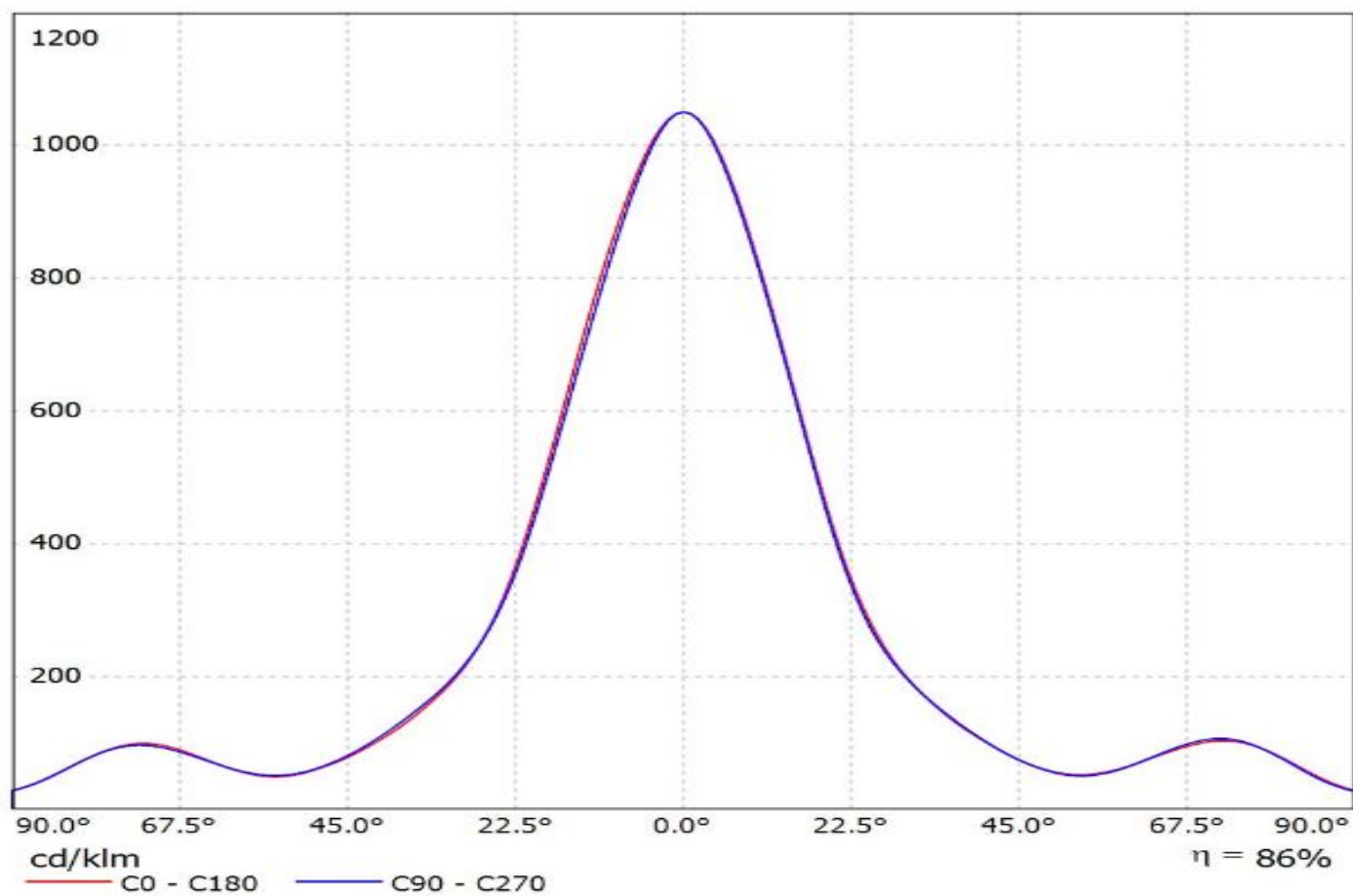

Luminaire: Ledil FN14720_STELLA-FRESNEL_(Vero29)

Lamps: 1 x Bridgelux_Vero29_(30-E10K0L-Y2)_1467.5lm@250mA_P=8.8850W_I=0.25A

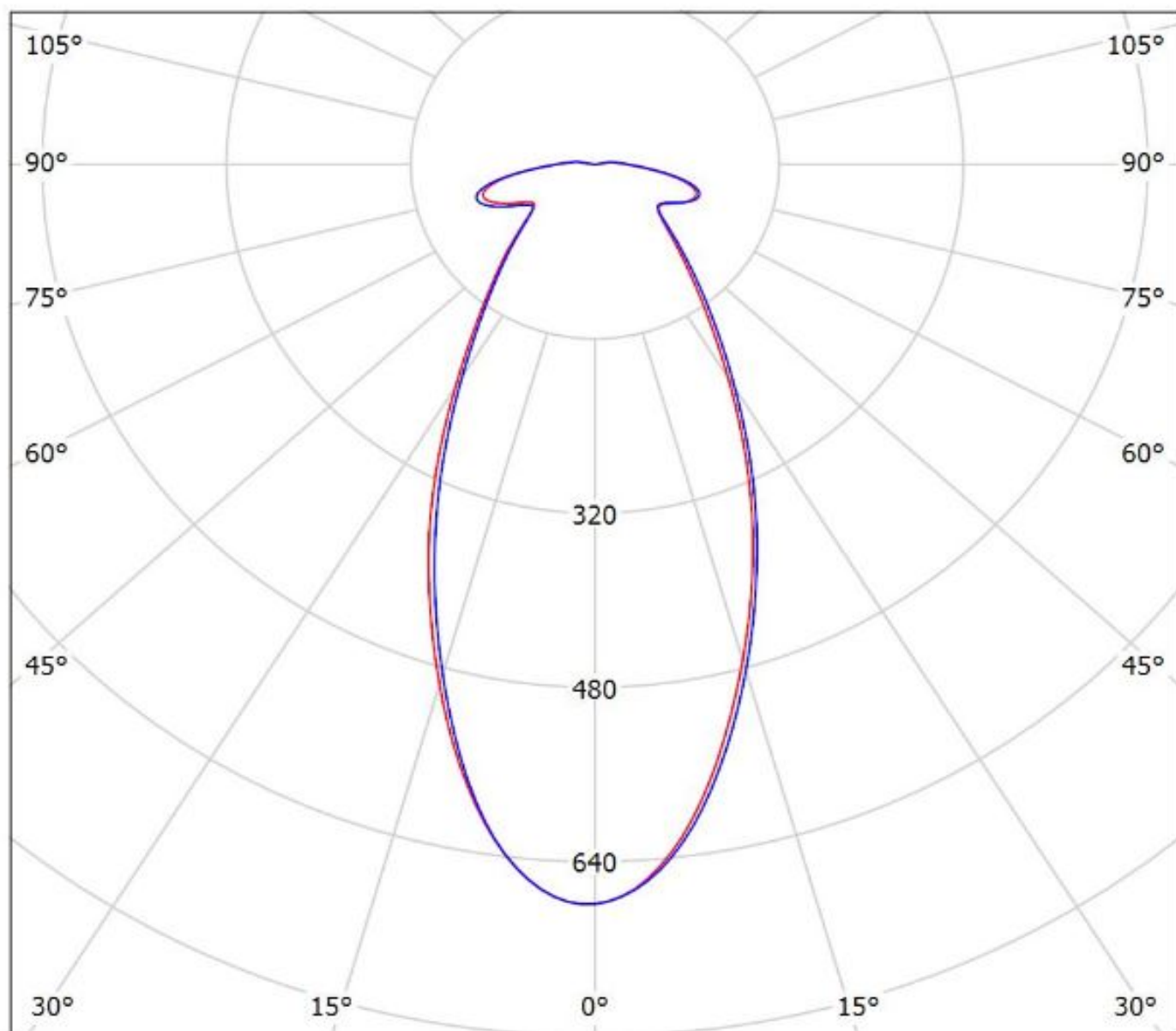

cd/klm

— C0 - C180

— C90 - C270

$\eta = 87\%$

Luminaire: LEDiL Oy FN14720_STELLA-FRESNEL_(CLU046)

Lamps: 1 x Citizen_CLU046_1354.66lm@250mA_P=8.06877W_I=0.2499A

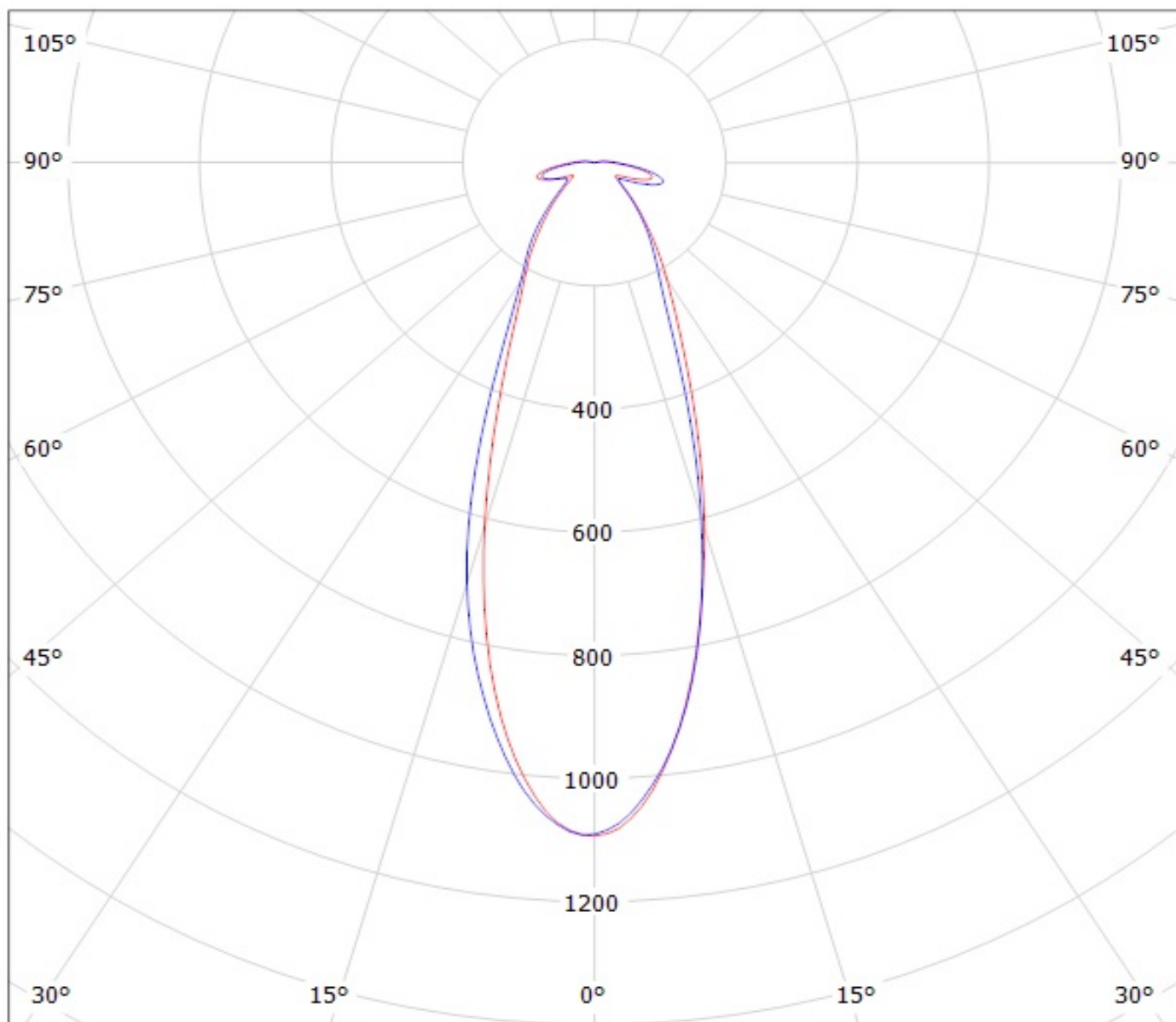

cd/klm

— C0 - C180

— C90 - C270

$\eta = 86\%$

Luminaire: Ledil Oy FN14720_STELLA-FRESNEL_(CXA3590)_SIMULATED
Lamps: 1 x Cree CXA3590

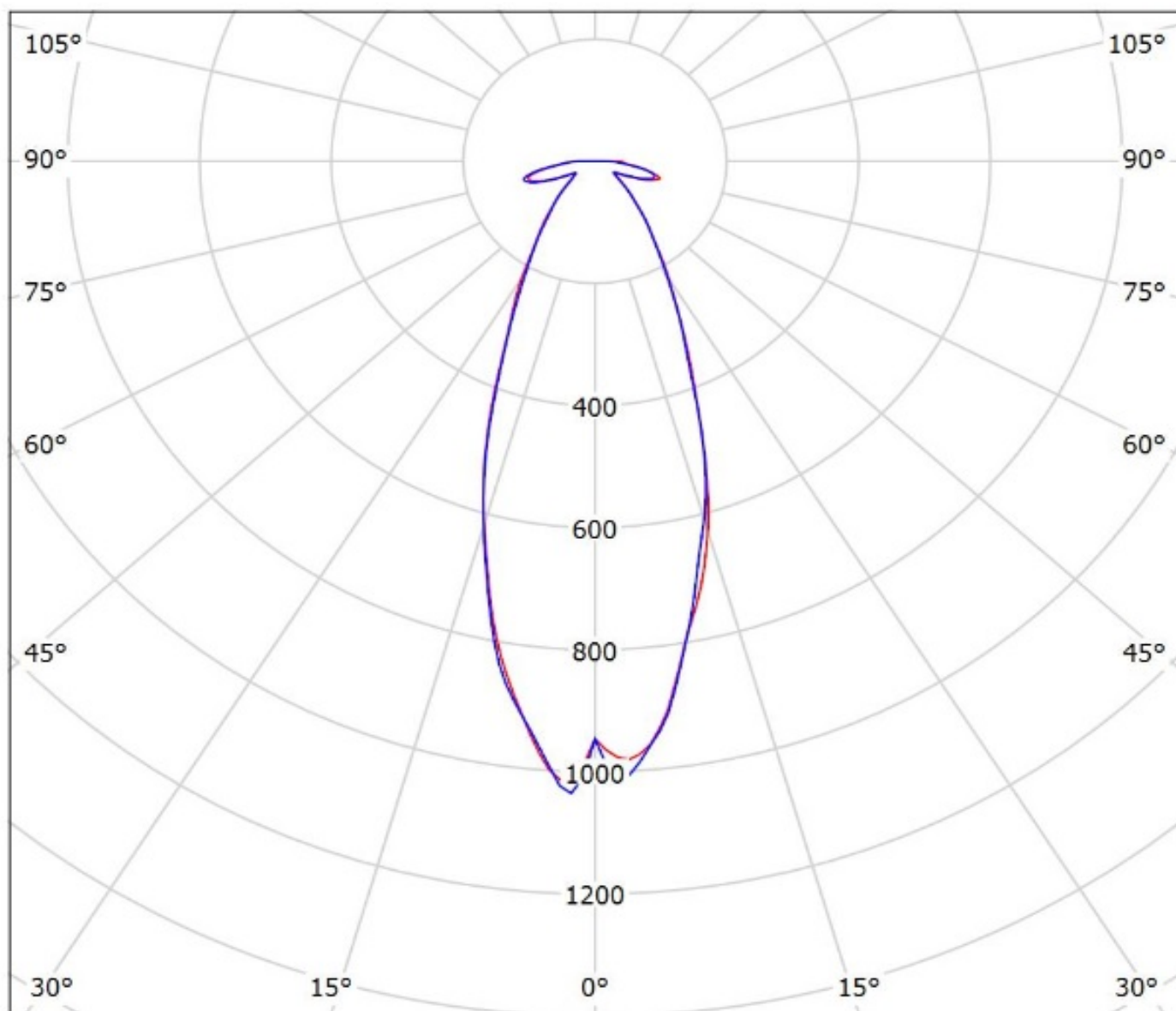

cd/klm
— C0 - C180 — C90 - C270

$\eta = 83\%$

Luminaire: Ledil Oy FN14720_STELLA-FRESNEL_(CXA2590)_SIMULATED
Lamps: 1 x Cree CXA2590

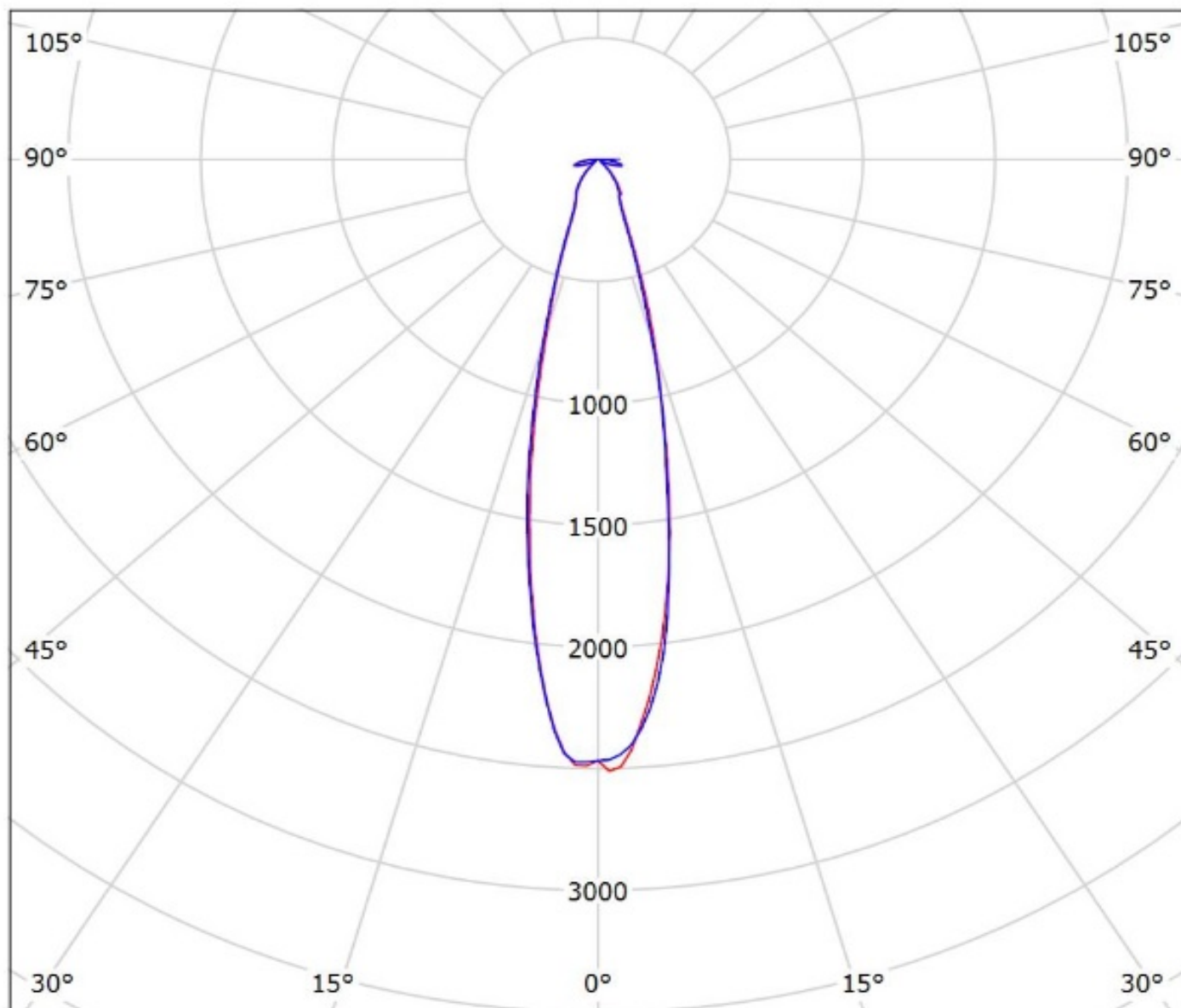

cd/klm

— C0 - C180 — C90 - C270

$\eta = 83\%$

Luminaire: Ledil FN14720_STELLA-FRESNEL_(CXB3070_+BJB)

Lamps: 1 x Cree_CXB3070_(-30G-AD-N0H-0001)_+BJB_47.319.2150_1399.52lm@250mA_CCT=3000K_P=8.0355W_I=0.25A

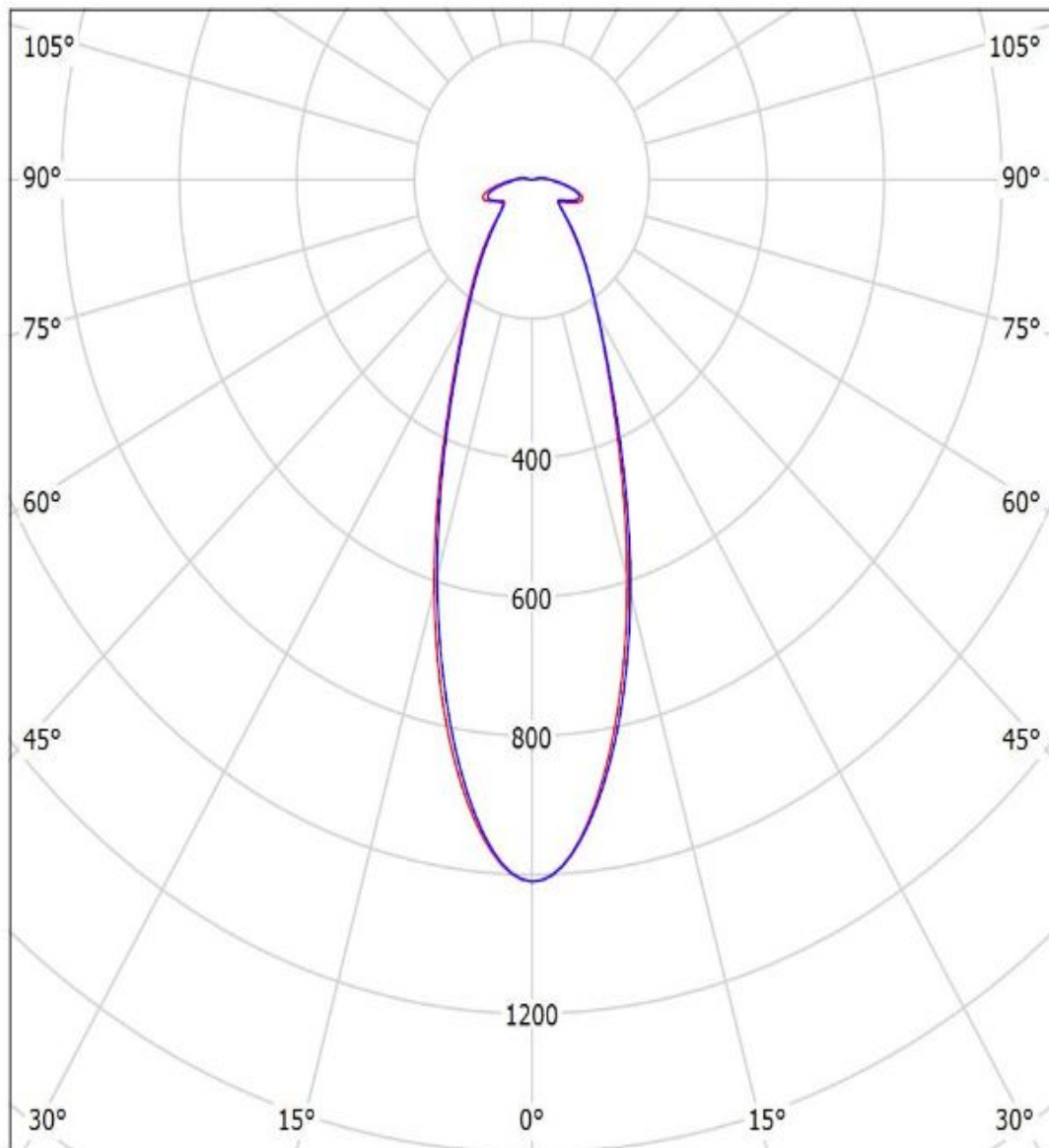

cd/klm

— C0 - C180 — C90 - C270

$\eta = 88\%$

Luminaire: Ledil FN14720_STELLA-FRESNEL_(CoB_1216)

Lamps: 1 x Luxeon_CoB_1216_(L2C2-40801216E2300)_1468.12lm@250mA_P=7.9868W_I=0.25A

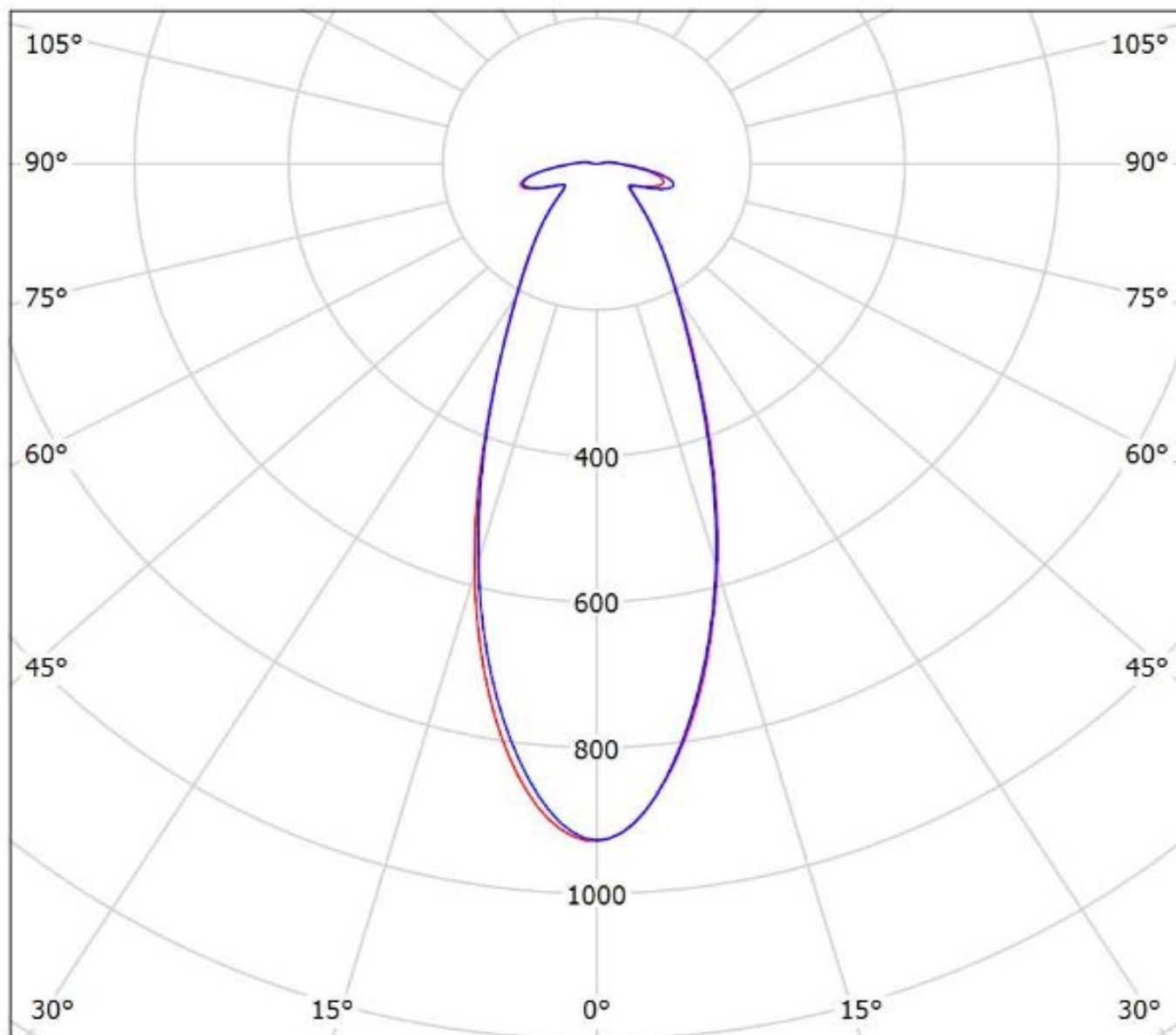

cd/klm

— C0 - C180 — C90 - C270

$\eta = 86\%$

Luminaire: Ledil Oy FN14720_STELLA-FRESNEL_(Luxeon_CoB_1208)_SIMULATED
Lamps: 1 x Lumileds Luxeon CoB 1208

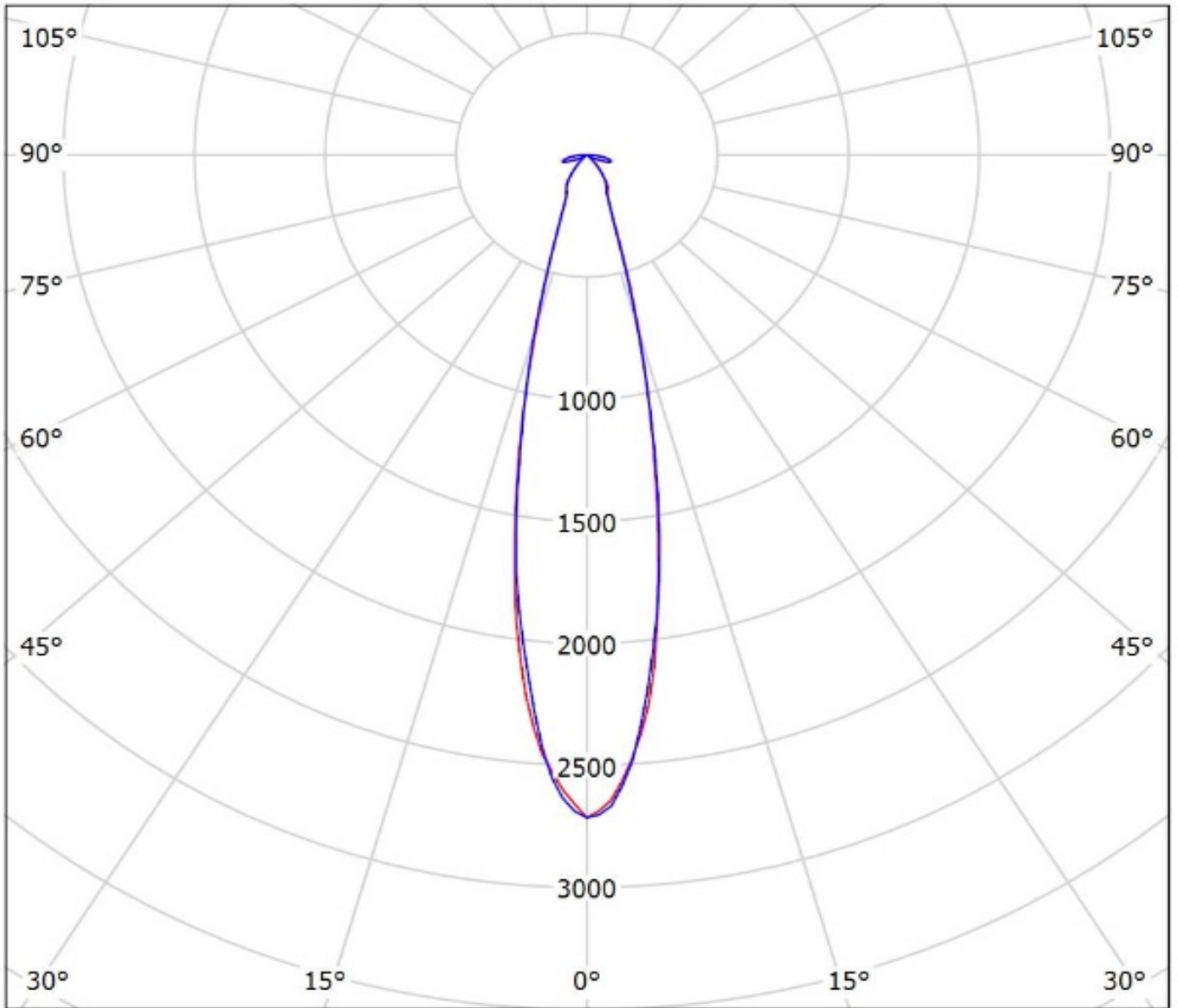

cd/klm

— C0 - C180 — C90 - C270

$\eta = 82\%$

Luminaire: Ledil FN14720_STELLA-FRESNEL_(CXM-22_+BW)

Lamps: 1 x LUMINUS_CXM-

22_+Bender&Wirth_431TypL3_1259.61lm@250mA_P=8.0332W_CCT=3000K_I=0.25A

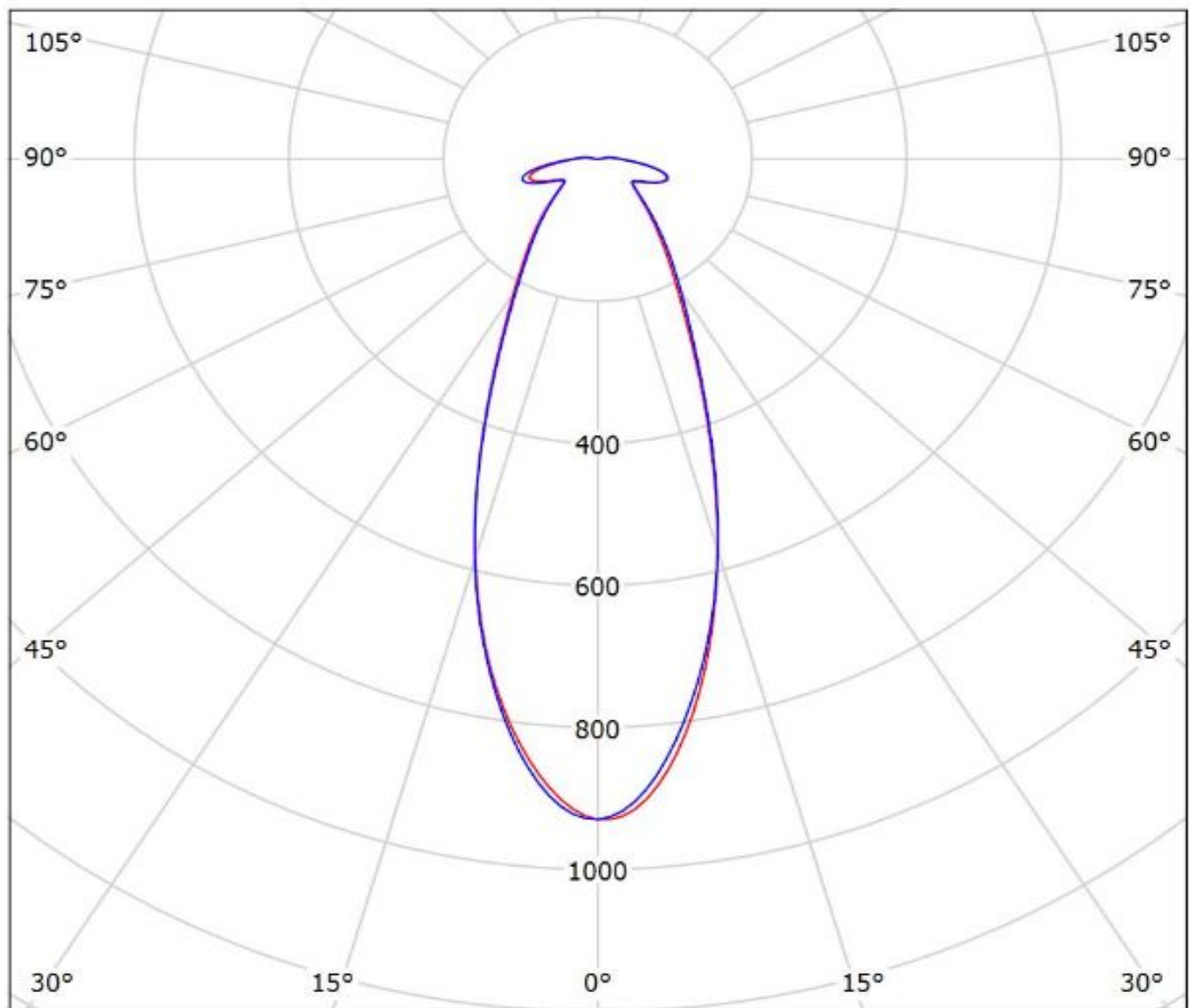

cd/klm

— C0 - C180

— C90 - C270

$\eta = 86\%$

Luminaire: LEDiL Oy FN14720_STELLA-FRESNEL_(Soleriq_P13)_Cav1

Lamps: 1 x Osram_Soleriq_P13_(GQ_MAGMB1.EM)_922.464lm@250mA_P=8.69804W_I=0.2498A

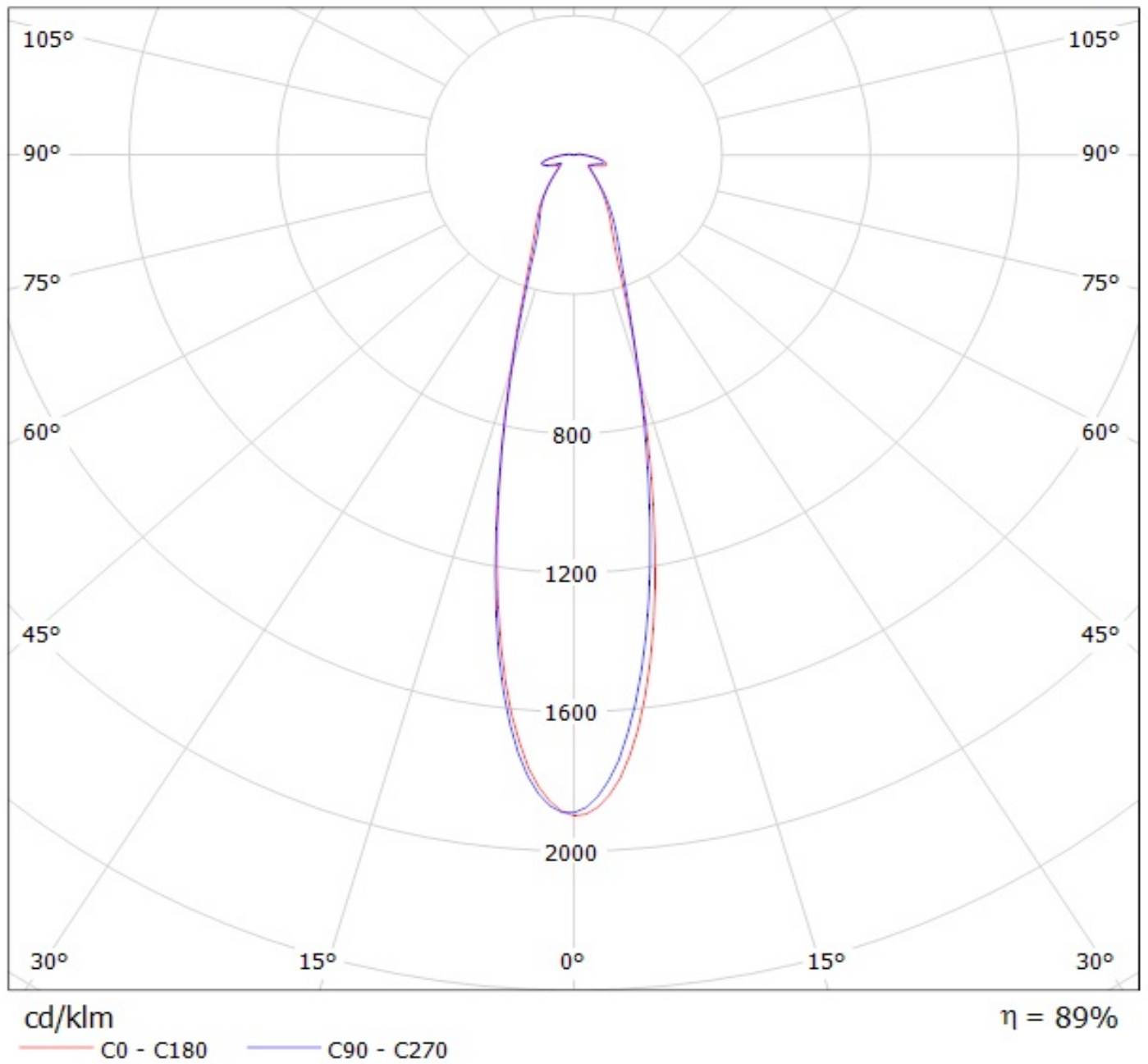

Luminaire: Ledil FN14720_STELLA-FRESNEL_(Soleriq_S19)

Lamps: 1 x Osram_Soleriq_S19_(GW-KAHJB1.EM)_1487.02lm@250mA_P=10.562W_I=0.25A

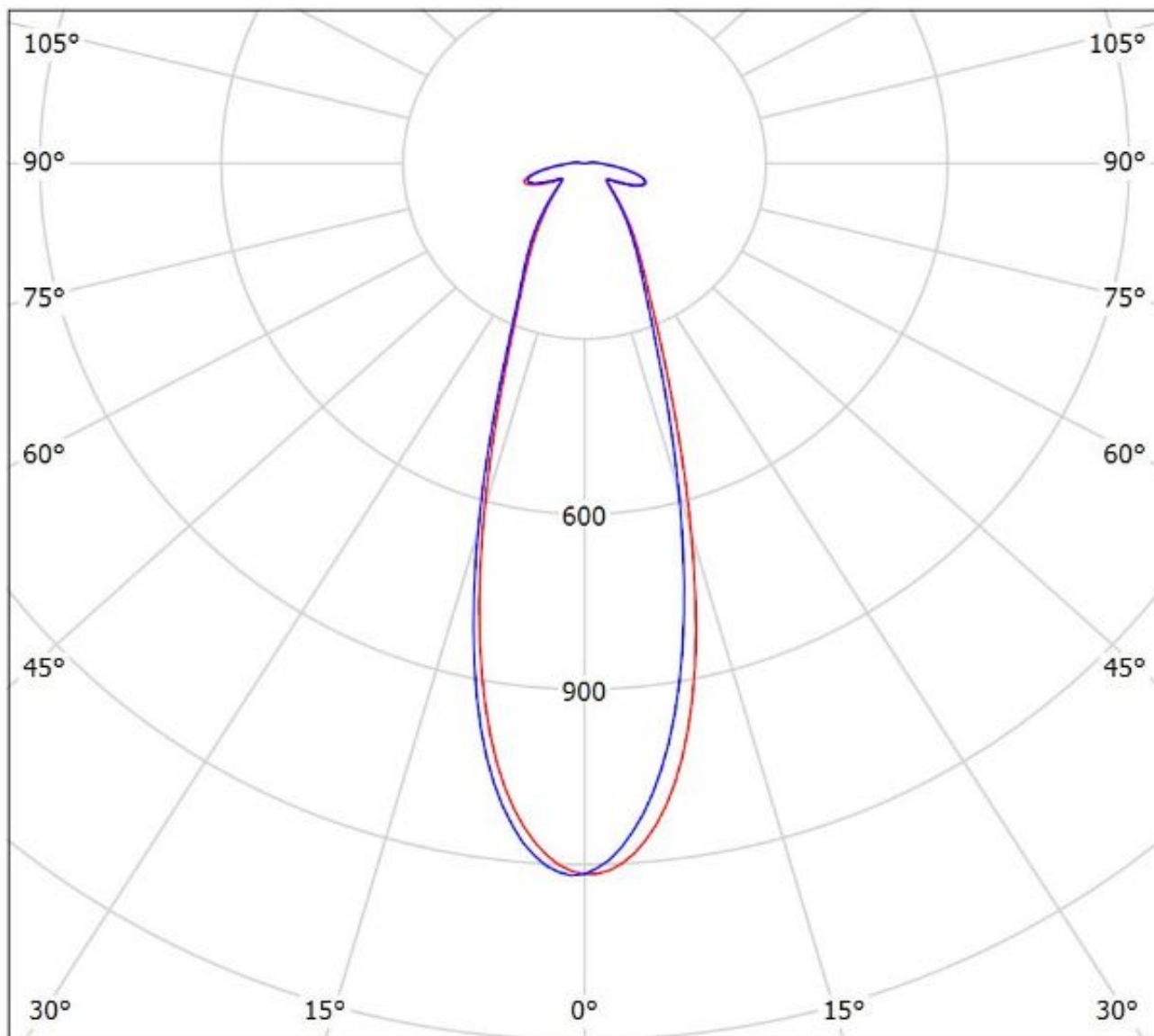

cd/klm

— C0 - C180 — C90 - C270

$\eta = 85\%$

Luminaire: LEDiL Oy FN14720_STELLA-FRESNEL_(SLM_1211_L19_G6)

Lamps: 1 x Philips_Fortimo_SLM_1211_L19_G6_Poke-In_1152.17lm@250mA_P=8.10051W_I=0.25A

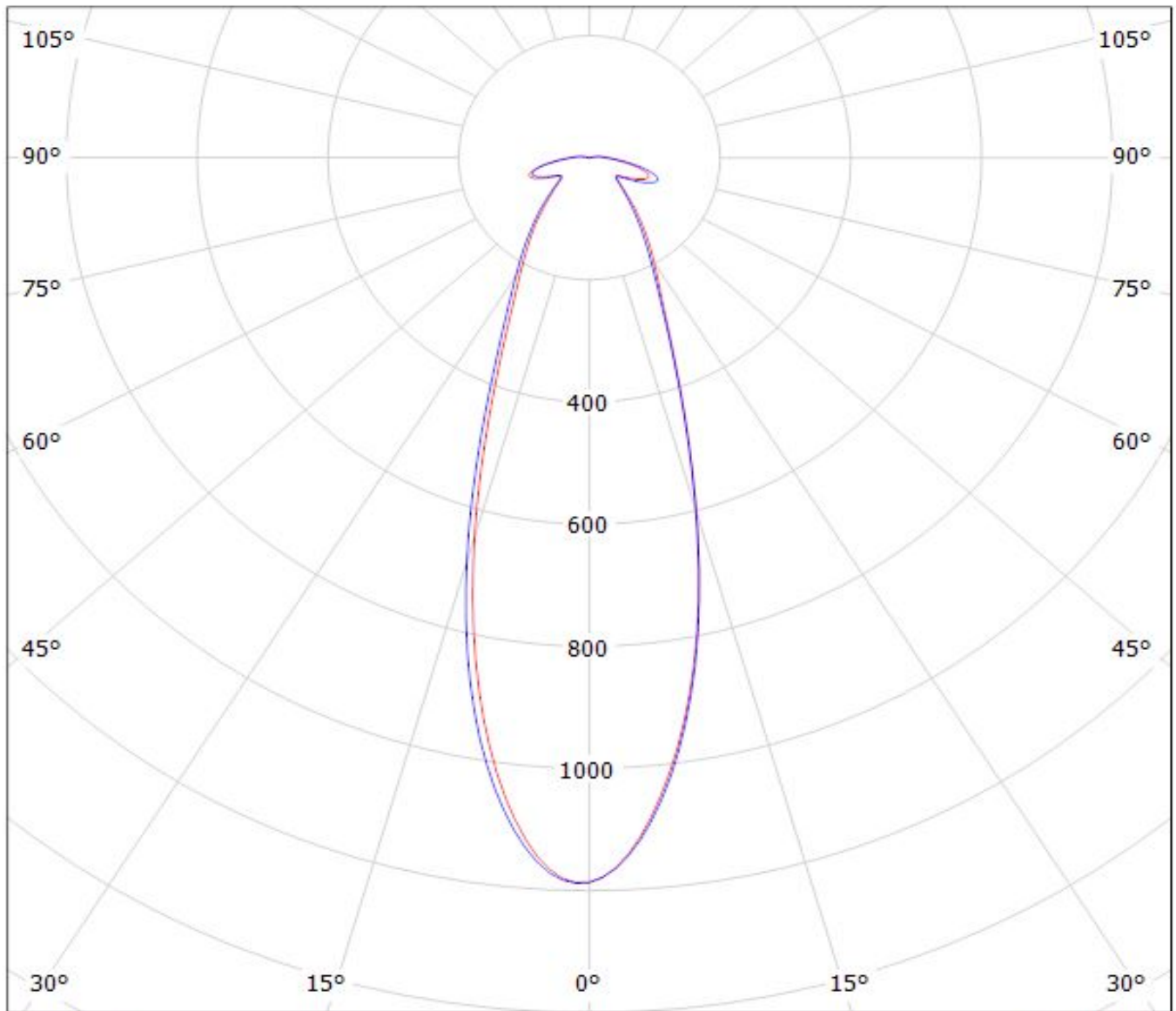

cd/klm

$\eta = 87\%$

— C0 - C180

— C90 - C270

Luminaire: LEDiL Oy FN14720_STELLA-FRESNEL_(SLE-G5_LES-19)
Lamps: 1 x Tridonic_SLE-G5_LES-19_1189.9lm@250mA_P=8.3068W_I=0.250A

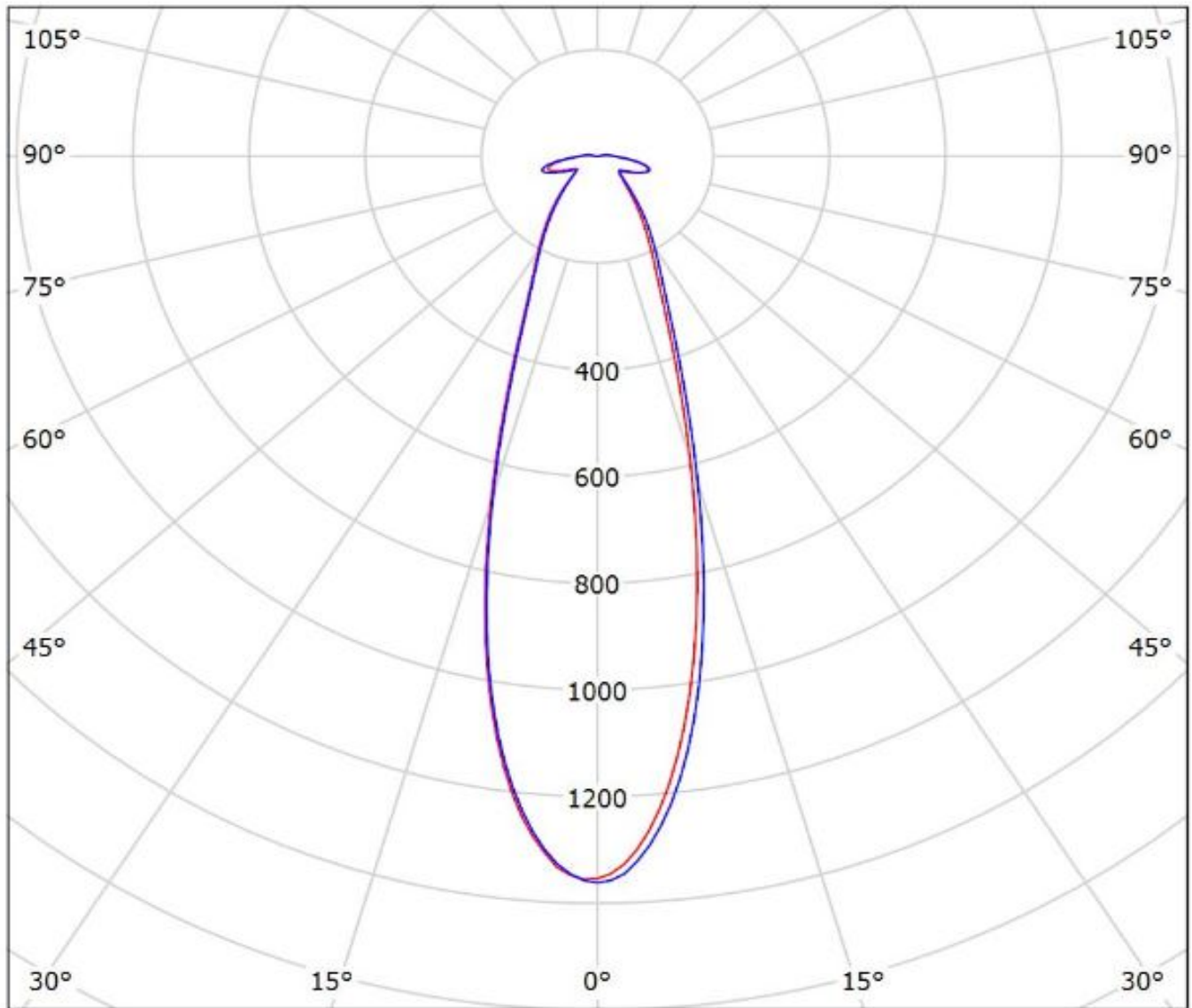

cd/klm

— C0 - C180 — C90 - C270

$\eta = 86\%$

Luminaire: LEDiL Oy FN14720_STELLA-FRESNEL_(SLE-G5_LES-23)

Lamps: 1 x Tridonic_SLE-G5_LES-23_1408.28lm@250mA_P=8.1392W_I=0.250A

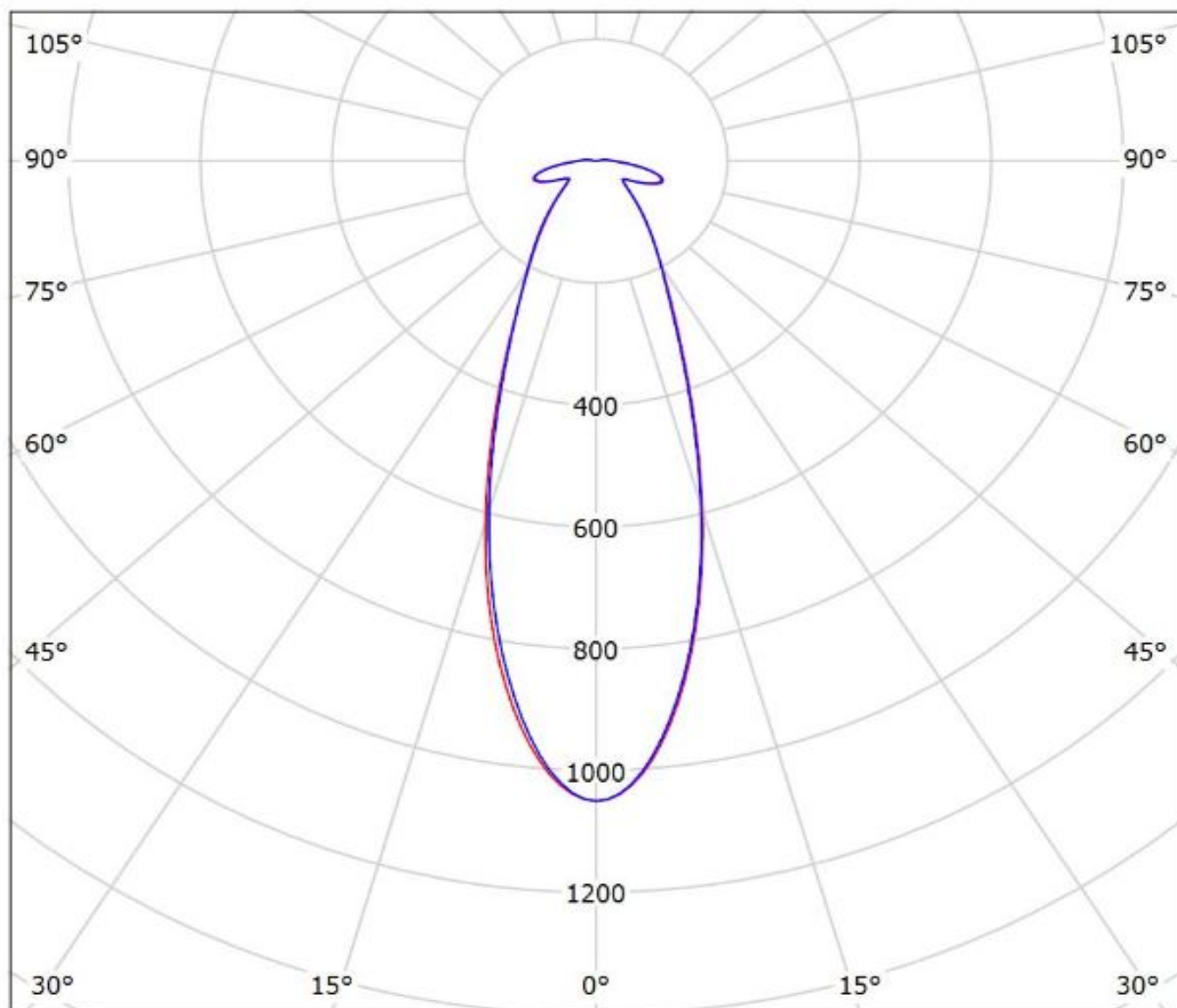

cd/klm

— C0 - C180 — C90 - C270

$\eta = 86\%$

NOTE: The typical divergence will be changed by different color, chip size and chip position tolerance. The typical total divergence is the full angle measured where the luminous intensity is half of the peak value.

GENERAL INFORMATION

- Product series especially designed & optimized for series of LEDs.
- Special care taken to make light distribution as uniform as possible.

Note! Due to use of high power COB's with this product, special attention to proper thermal design is highly recommended. LEDiL has no liability for direct, indirect or consecutive damages arising from the LEDiL products being used outside of the recommended temperature range.