

IRIS

~5° real spot beam optimized for CREE XP-E.
Assembly with holder and installation tape.

TECHNICAL SPECIFICATIONS:

Dimensions	Ø 38 mm
Height	27.1 mm
Fastening	glue, tape, pin, screw
Colour	black
Box size	480 x 280 x 300 mm
Box weight	8.9 kg
Quantity in Box	378 pcs
ROHS compliant	yes ⓘ



MATERIAL SPECIFICATIONS:

Component	Type	Material	Colour
IRIS	Lens	PMMA	clear
IRIS-XP-HLD-TAPE	Holder	PC	black

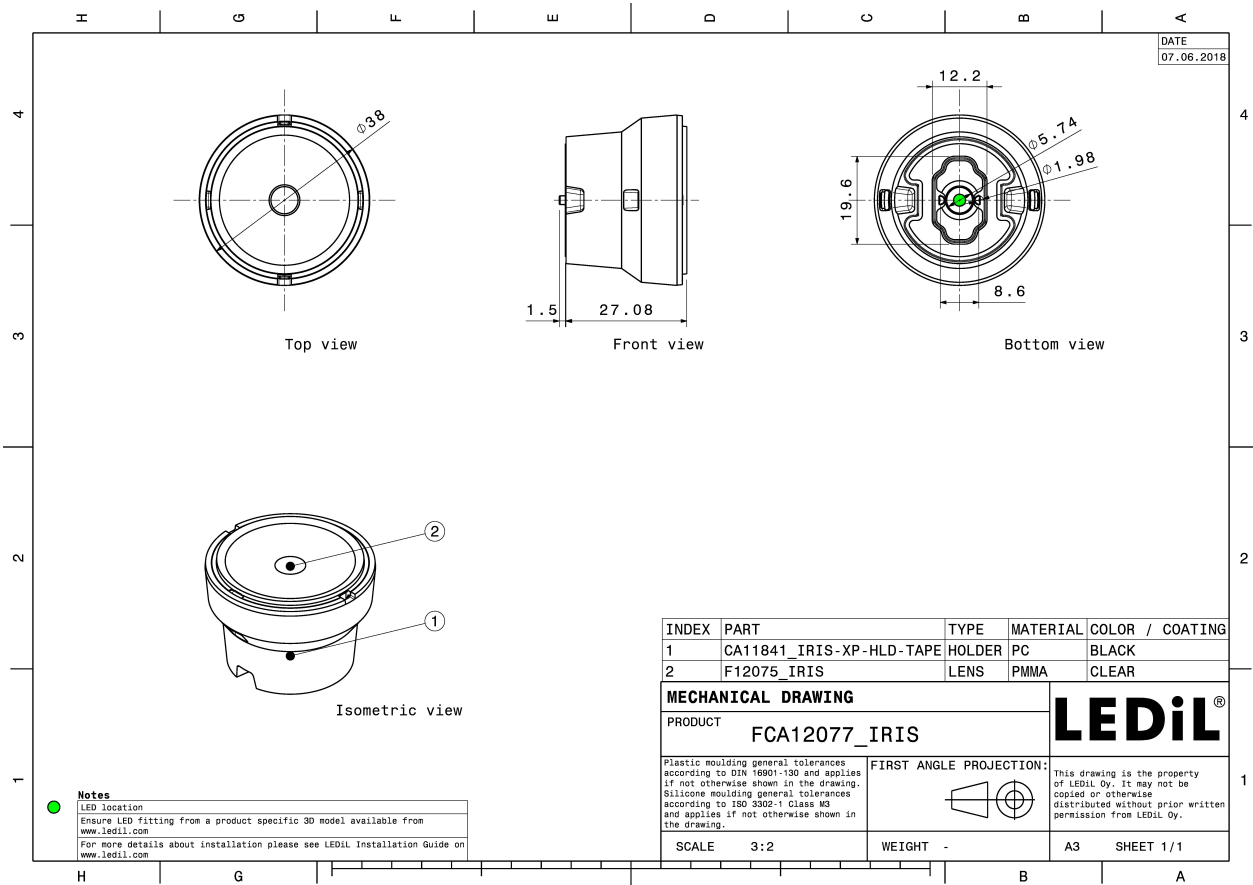

PHOTOMETRIC DATA (MEASURED):



LED XHP35 HD
 FWHM 10.0°
 Efficiency 89 %
 Peak intensity 18.560 cd/lm
 Required components:

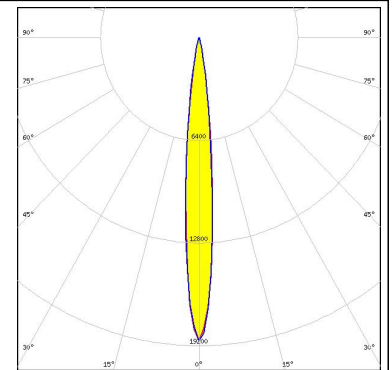
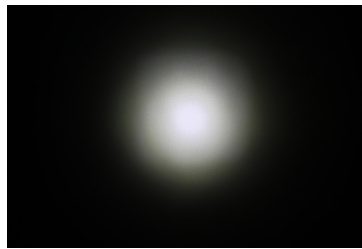

LED XHP35 HI
 FWHM 7.6°
 Efficiency 90 %
 Peak intensity 35.900 cd/lm
 Required components:

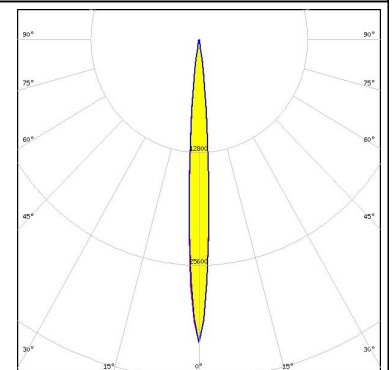

LED XP-E
 FWHM 4.0°
 Efficiency 93 %
 Peak intensity 87.400 cd/lm
 Required components:

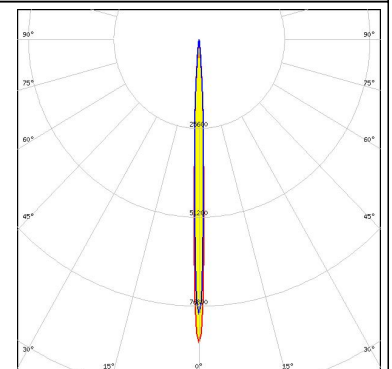
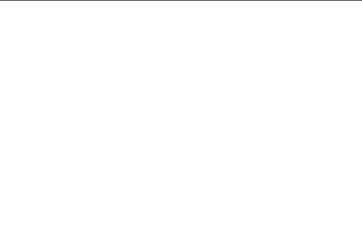

LED XP-E2
 FWHM 5.0°
 Efficiency 93 %
 Peak intensity 103.900 cd/lm
 Required components:

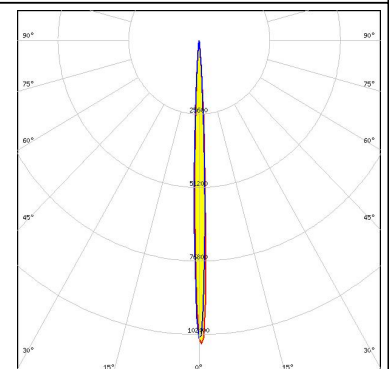

PHOTOMETRIC DATA (MEASURED):

CREE 

LED XP-G
FWHM 6.0°
Efficiency 94 %
Peak intensity 46.400 cd/Im
Required components:

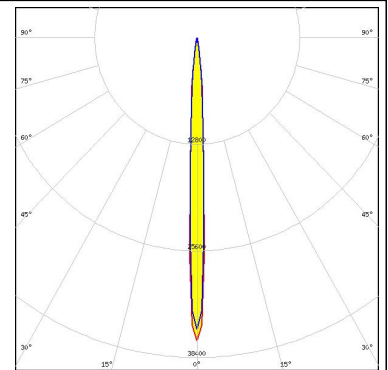
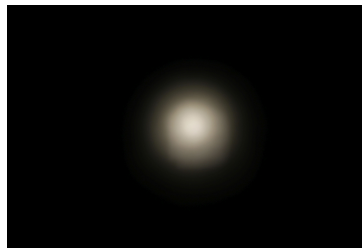

CREE 

LED XP-G2
FWHM 6.0°
Efficiency 95 %
Peak intensity 46.000 cd/Im
Required components:

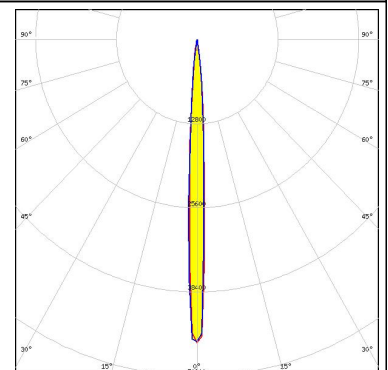

CREE 

LED XQ-E HI
FWHM 3.9°
Efficiency 88 %
Peak intensity 123.300 cd/Im
Required components:

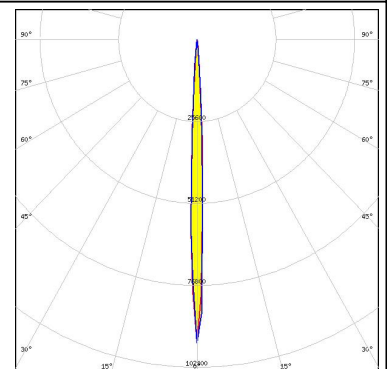

 **LG Innotek**

LED H35C1 (LEMWA33)
FWHM 8.0°
Efficiency 89 %
Peak intensity 40.400 cd/Im
Required components:

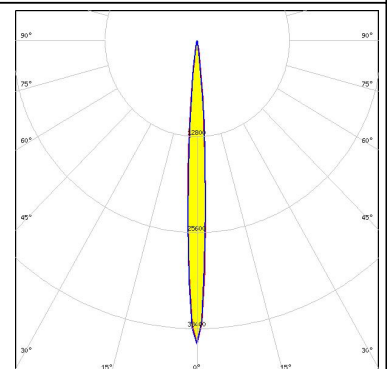

PHOTOMETRIC DATA (MEASURED):

LUMILEDS

LED LUXEON Rebel
FWHM 5.0°
Efficiency %
Peak intensity 75.600 cd/Im
Required components:

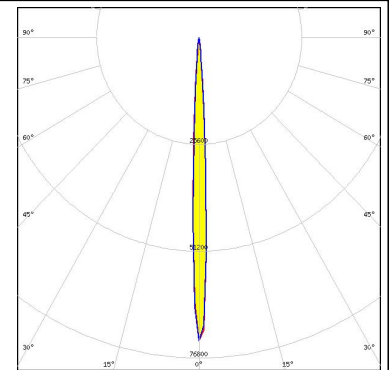

LUMILEDS

LED LUXEON Rebel ES
FWHM 7.0°
Efficiency 93 %
Peak intensity 38.500 cd/Im
Required components:

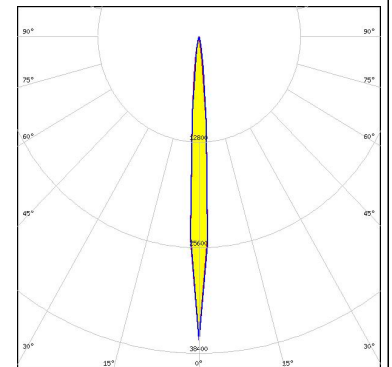

LUMILEDS

LED LUXEON T
FWHM 7.0°
Efficiency 94 %
Peak intensity 40.200 cd/Im
Required components:

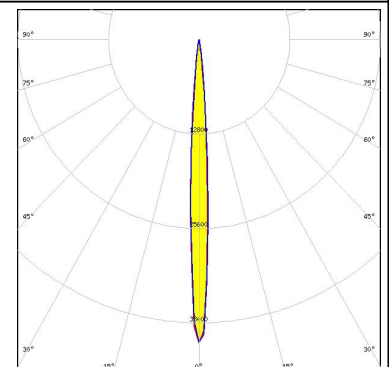
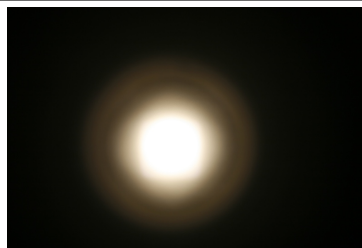

LUMILEDS

LED LUXEON TX
FWHM 6.9°
Efficiency 89 %
Peak intensity 43.100 cd/Im
Required components:

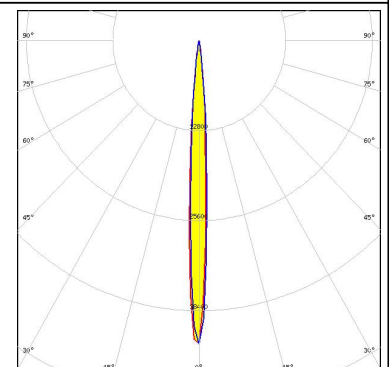

PHOTOMETRIC DATA (MEASURED):



LED LUXEON Z ES
 FWHM 4.0°
 Efficiency 93 %
 Peak intensity 94.060 cd/Im
 Required components:

Luminaire: LEDiL Oy FCA12077_IRIS (Z ES)
 Lamps: 1 x Philips Lumileds Luxeon Z ES (8X22-6070)
 _84 6528mg(250mA_P=0.730483W_P=249.9mA)

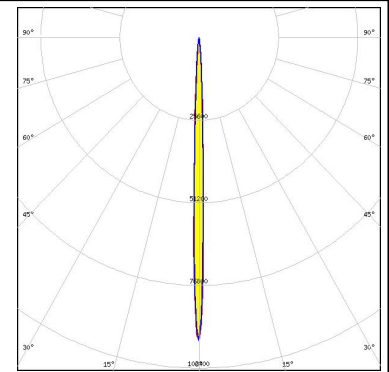
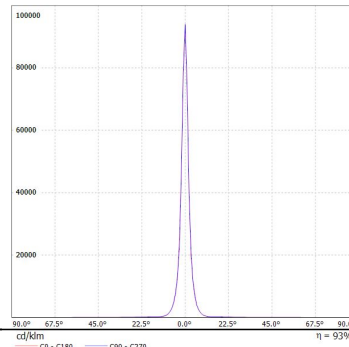

LED NCSxx19A
 FWHM 5.0°
 Efficiency %
 Peak intensity cd/Im
 Required components:

cd/Im C0 - C180 C90 - C270 $\eta = 93\%$



LED NVSW3x9A
 FWHM 8.0°
 Efficiency 89 %
 Peak intensity 26.300 cd/Im
 Required components:

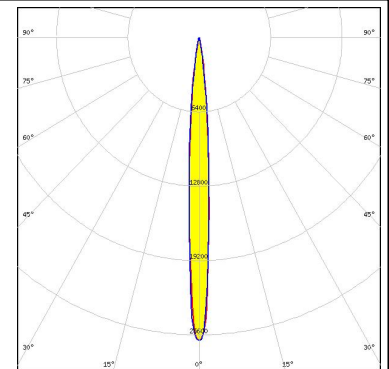

LED NVSxx19A
 FWHM 6.0°
 Efficiency 93 %
 Peak intensity 38.700 cd/Im
 Required components:

PHOTOMETRIC DATA (MEASURED):



LED NVSxx19B/NVSxx19C
 FWHM 7.0°
 Efficiency 92 %
 Peak intensity 36.600 cd/lm
 Required components:

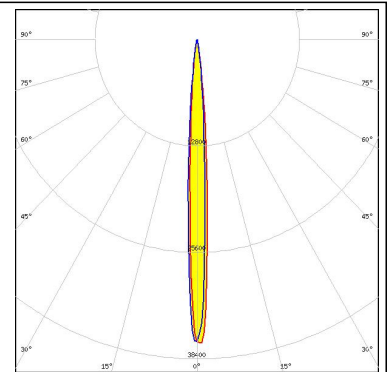

LED NWSx229A
 FWHM 10.0°
 Efficiency 91 %
 Peak intensity 18.600 cd/lm
 Required components:

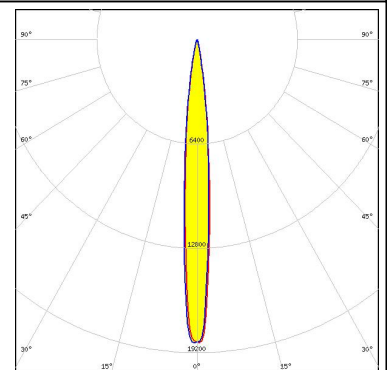

LED Oslon SSL 150
 FWHM 4.0°
 Efficiency 94 %
 Peak intensity 76.800 cd/lm
 Required components:

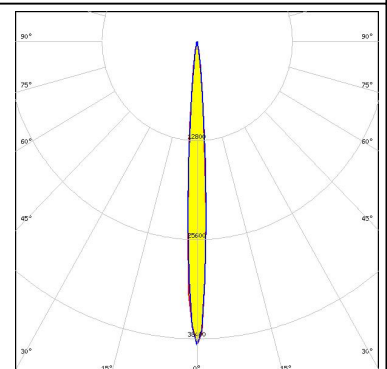
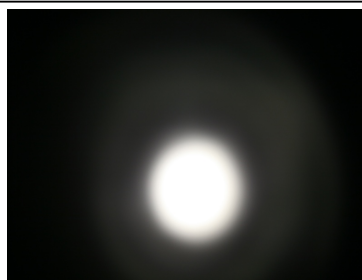

LED Oslon SSL 80
 FWHM 4.0°
 Efficiency 90 %
 Peak intensity 89.000 cd/lm
 Required components:

PHOTOMETRIC DATA (MEASURED):

SAMSUNG

LED LH351Z
FWHM 7.0°
Efficiency 89 %
Peak intensity 48.100 cd/lm
Required components:

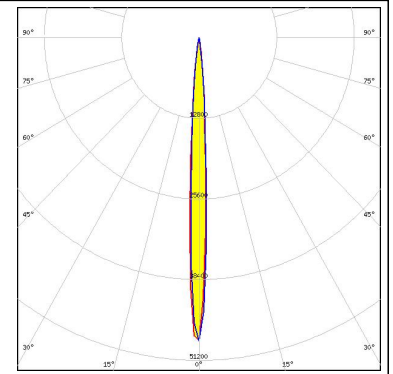
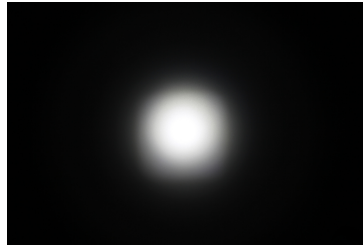

PHOTOMETRIC DATA (SIMULATED):



LED XP-G3
FWHM 7.7°
Efficiency 91 %
Peak intensity 28.700 cd/lm
Required components:

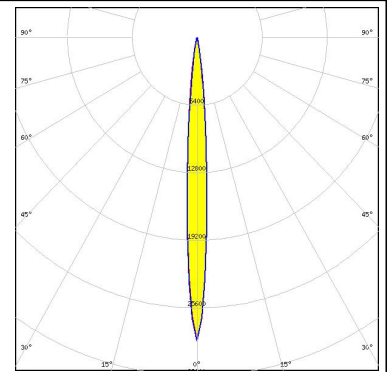

LED XQ-E
FWHM 5.3°
Efficiency 94 %
Peak intensity 77.800 cd/lm
Required components:

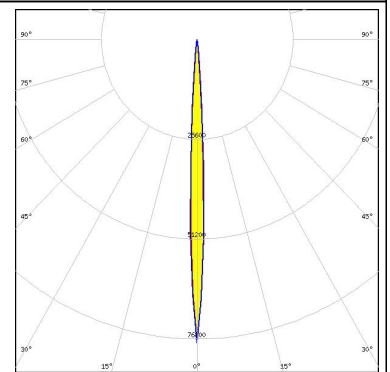

LED XQ-E
FWHM 5.0°
Efficiency 93 %
Peak intensity 80.000 cd/lm
Required components:



LED LUXEON H50-2
FWHM 7.0°
Efficiency 94 %
Peak intensity 38.600 cd/lm
Required components:

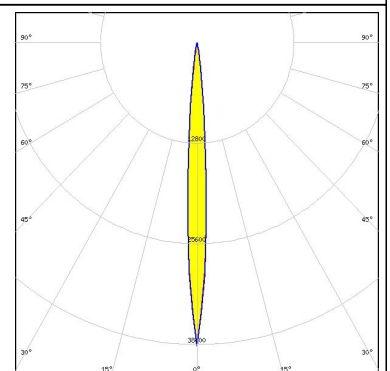

PHOTOMETRIC DATA (SIMULATED):

SAMSUNG

LED LH351D
FWHM 9.3°
Efficiency 90 %
Peak intensity 20.970 cd/lm
Required components:

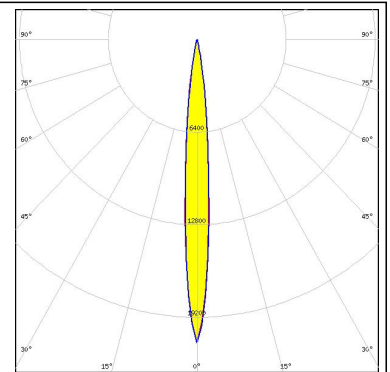

SEOUL SEMICONDUCTOR

LED Z8Y22P
FWHM 8.0°
Efficiency 98 %
Peak intensity 29.900 cd/lm
Required components:

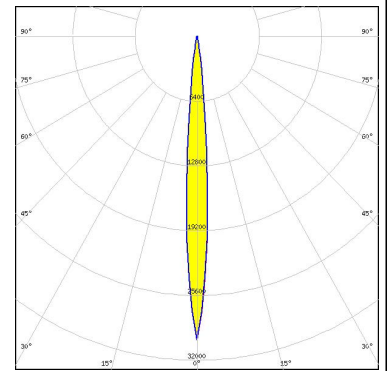

GENERAL INFORMATION:

NOTE: The typical beam angle will be changed by different color, chip size and chip position tolerance. The typical total beam angle is the full angle measured where the luminous intensity is half of the peak value.

MATERIALS:

As part of our continuous research and improvement processes, and to ensure the best possible quality and availability of our products, LEDiL reserves the right to change material grades without notice.

PRODUCT DATA USER AGREEMENT AND DISCLAIMER:

The measured data in the provided downloadable LEDiL Product Datasheets and Mechanical 2D-Drawings is rounded and provided as reference for planning. LEDiL Oy's optical specifications have been verified by conducting performance testing of the products in accordance with the company's quality system. The reported data are averaged results of multiple measurements with typical variation. LEDiL Oy reserves the right to without prior notification make changes and improvements to its products.

LEDiL Oy assumes neither warranty, nor guarantee nor any other liability of any kind for the contents and correctness of the provided data. The provided data has been generated with highest diligence but the provided data may in reality not represent the complete possible variation range of all intrinsic parameters. Therefore, in certain cases a deviation from the provided data could occur.

LEDiL Oy reserves the right to undertake technical changes of its products without further notification which could lead to changes in the provided data. LEDiL Oy assumes no liability of any kind for the possible deviation from any provided data or any other damage resulting from the usage of the provided data.

The user agrees to this disclaimer and user agreement with the download or usage of the provided files.

LEDiL Oy

Joensuunkatu 13
FI-24240 SALO
Finland

LEDiL Inc.

228 West Page Street
Suite D
Sycamore IL 60178
USA

Local sales and technical support

[www.ledil.com/
where_to_buy](http://www.ledil.com/where_to_buy)

Shipping locations

Salo, Finland
Hong Kong, China

Distribution Partners

[www.ledil.com/
where_to_buy](http://www.ledil.com/where_to_buy)

Mouser Electronics

Authorized Distributor

Click to View Pricing, Inventory, Delivery & Lifecycle Information:

[Ledi:](#)

[FCA12077_IRIS](#)