

Datasheet

LL03ZZ-CRO××L06

Available Distribution

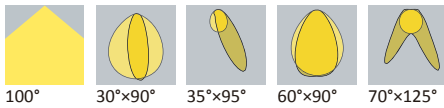

100° 30°×90° 35°×95° 60°×90° 70°×125°

Dimensions

Part Number	Height	L×W
LL03ZZ-CRO100L06	9.45	
LL03ZZ-CRO3090L06	9.45	
LL03ZZ-CRO3595L06	11.4	286×61
LL03ZZ-CRO6090L06	9.45	
LL03ZZ-CRO701250L06	9.9	

*All dimensions are in millimeters.

LED



LG Innotek
5630

Packaging Details (SPQ)

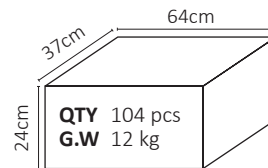

Recommnd Applications



Commercial Indoor Area

General Information



- Lens Material PMMA 8N
- Operating Temperature -40°C~+70°C
- Light Transmission Rate 400nm~900nm > 90%
- ☑ If necessary, Clean lenses with mild soap, water and soft cloth.
- ⚠ Never use any commercial cleaning solvents on lenses, like alcohol.
- ⚠ Please handle or install lenses with wearing gloves, skin oils may damage lens or its optical characteristic.

Mechanical Specification

*All dimensions are in millimeters.

Lens Dimension



Assembly Instruction

Fixing Method

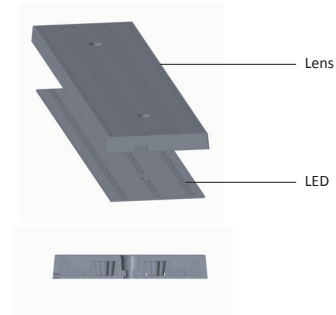
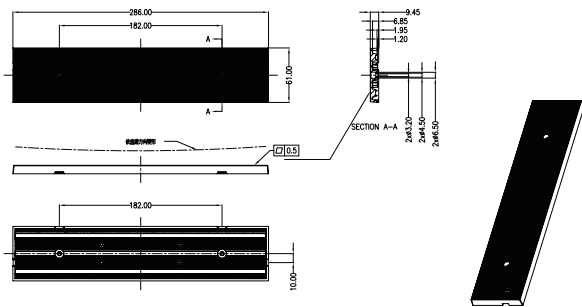

Set Up Instruction

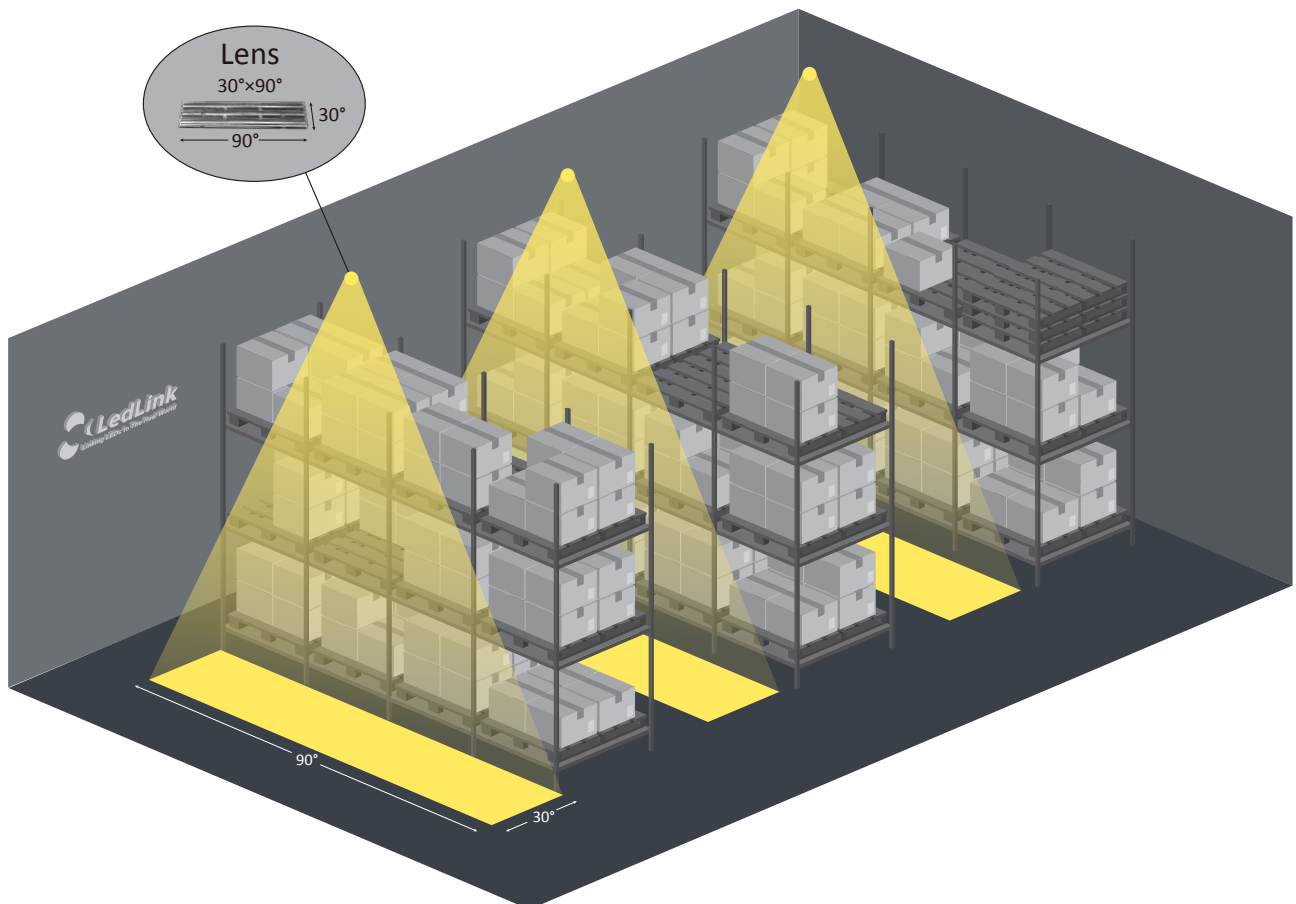

Photometric Distribution



LG Innotek
5630

Distribution

100°

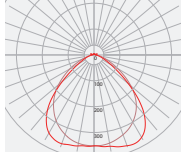

30°×90°

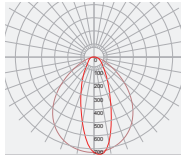

35°×95°

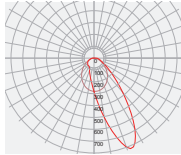

60°×90°

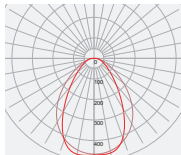

70°×125°

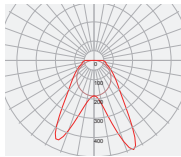

Details by LED

Part No	Accessories	LED Package Size	LED
LL03ZZ-CROxxL06	-	5630	 LG Innotek 5630

LED	Part No	FWHM	cd / lm	IES
 LG Innotek 5630	LL03ZZ-CRO100L06	96°	0.3	↓
	LL03ZZ-CRO3090L06	35°×93°	0.7	↓
	LL03ZZ-CRO3595L06	32°×91°	0.8	↓
	LL03ZZ-CRO6090L06	68°×89°	0.4	↓
	LL03ZZ-CRO70125L06	72°×116°	0.5	↓

Product Nomenclature

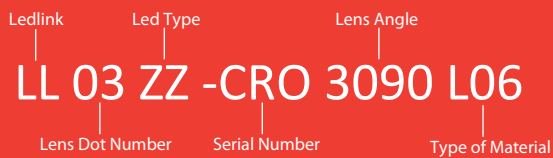

Ledlink Optics, Inc Taiwan HQ

15F, No.655, Bannan Rd., Chung-Ho Dist.,
New Taipei City, Taiwan 235

Ledlink Optics (Dongguan) Co., Ltd Dongguan Factory

No.5, TianKeng Industrial Dist., HengLiTown, DongGuan City,
GuangDong Province, China 523478

Ledlink Optics (Yangzhou) Co., Ltd Yangzhou Factory

No.180, LinJiang Rd., YangZhou City, Jiangsu Province, China 225009

www.ledlink-optics.com

service@ledlink-optics.com

