

# Data Sheet

LL02CR-AUH45135L52

**CREE**   
▶ LED Solution Provider



## ■ Features & Typical Applications

- High efficiency
- Optimized Uniformity
- Roadway Lighting
- Anti-glare

## ■ Table of Contents

General Information & Product Nomenclature.....	P.2
Optical Specifications .....	P.3
Mechanical Specifications .....	P.4

# LL02CR-AUH45135L52

## General Information

- Lens Material : PCL 1225Z
- Operating Temperature range -40°C~+110°C(upper limit +120°C)
- Storage Temperature range -40°C~+110°C(upper limit +120°C)
  - \* Average transmittance in visible spectrum 400nm~700nm>90%
- Usage and Maintenance:
  1. If necessary, clean lenses with mild soap, water and soft cloth.
  2. Never use any commercial cleaning solvents on lenses, like alcohol.
  3. Please handle or install lenses with wearing gloves, skin oils may damage lens or its optical characteristic.

## Product Nomenclature

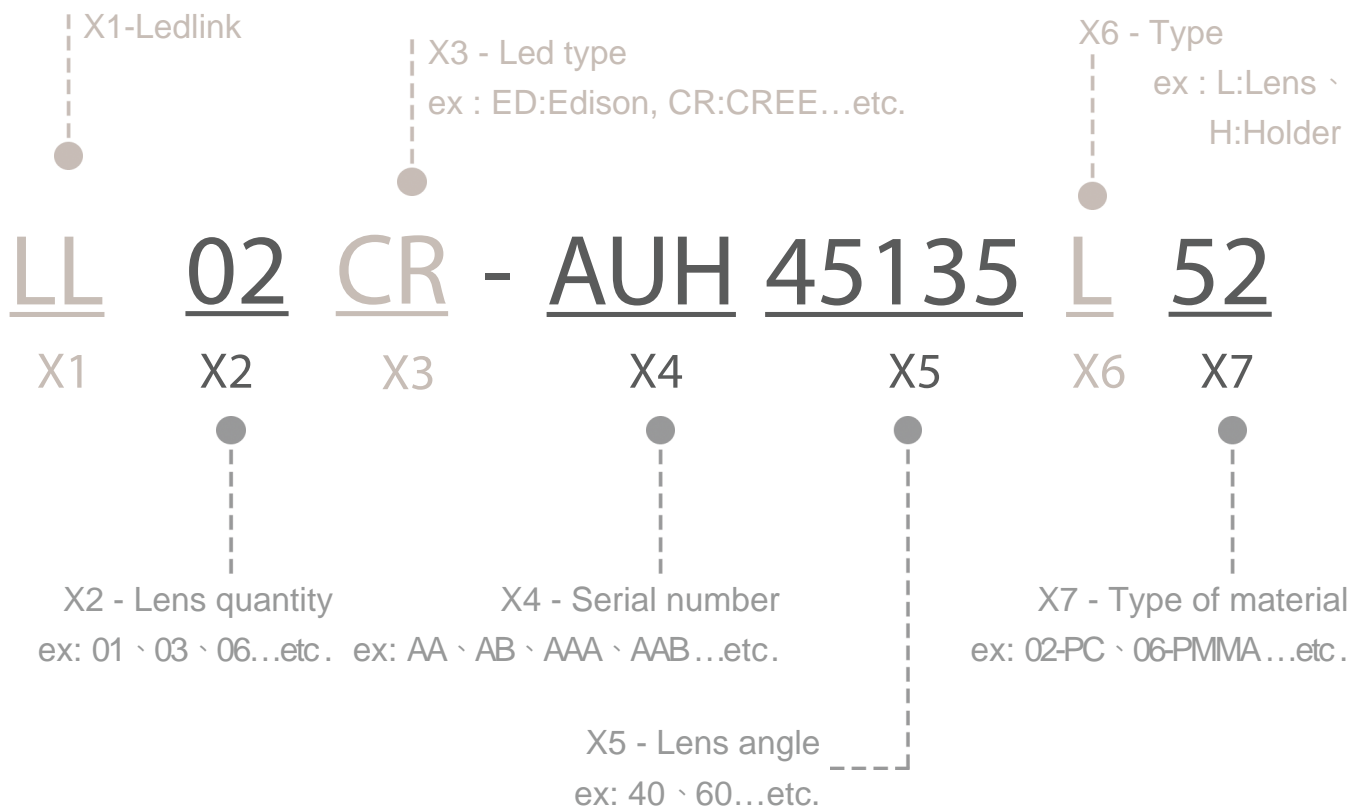

# LL02CR-AUH45135L52 Optical Specifications

**CREE**   
LED Solution Provider

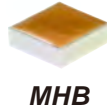

Note: (1) All the results of analysis are based on 10 degrees of elevation.  
(2) Tolerance:  $\pm 10\%$ .  
(3) Led Luminous Flux(lm): 457 ( $\pm 5\%$ ).

IES File: [Download](#)

@elevation 0°

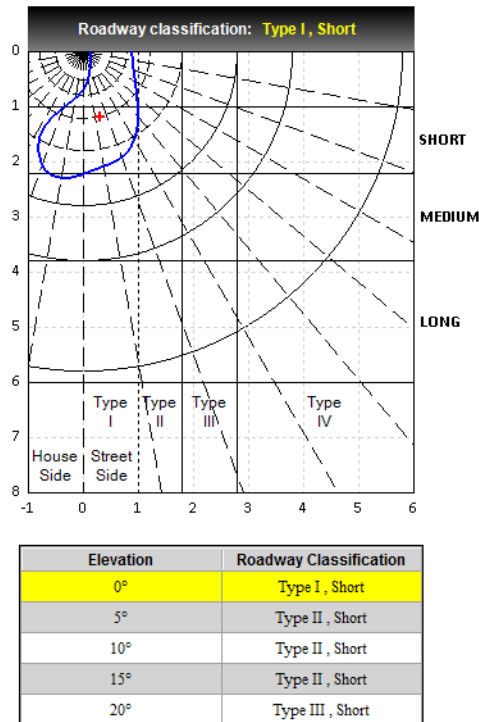
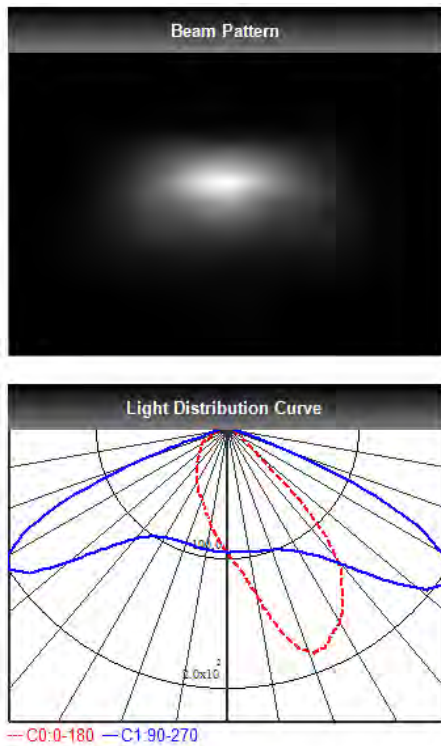

DIALux Simulation Result

Analyzed file: [Download](#)

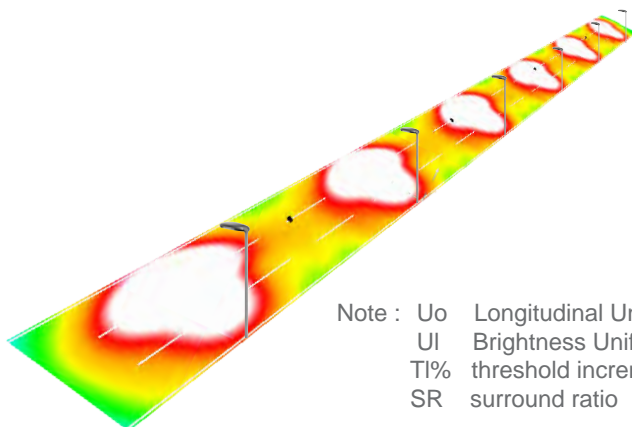

Note : Uo Longitudinal Uniformity  
UI Brightness Uniformity  
TI% threshold increment  
SR surround ratio

Recommend configuration condition		
Height	=	10m
Distance	=	40m
Roadwidth	=	12m
Elevation	=	0 degree
Overhang	=	1.0m
Result		
Emin / Emax	=	0.38
Emin / Eavg	=	0.64
UI	=	0.33
Uo	=	0.47
TI	=	5%
SR	=	0.6

\*The results would be similar if the configuration conditions are equally magnified or minified.

\*This testing result is obtained through testing the popular rank LED samples which provided by the original manufacturer. Hence, the testing results would be varied as the users choose same LED model but different rank.

\*The analyzed file require DIALux v4.11 and above to open.

# LL02CR-AUH45135L52

## Mechanical Specification

### 1. Fixing method

- Glue
- Screw
- Tape
- Fixing-ring
- Frame

Note: (1) All dimensions are in mm.  
 (2) All measurements are  $\pm 0.15$  mm unless otherwise indicated.

### 2. Lens dimension

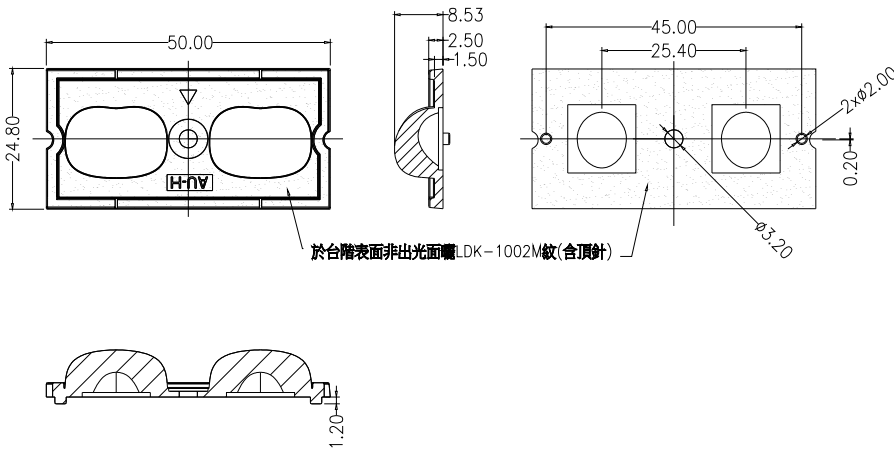

### 3. Assembly instruction

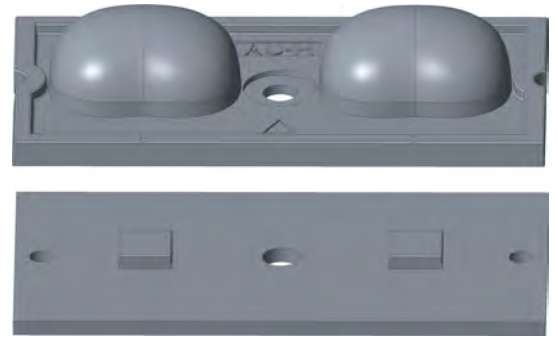

### 4. Assembly dimension

### 5. View assembly lens with LED:

