

Data Sheet

LL01CR-BCQxxL06

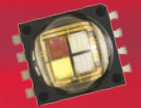

MC-E(RGBW)



■ Features & Typical Applications

- High efficiency
- Available with 2 beam angles
- Optimized for uniform effect
- Lens without Housing
- Spotlight
- Architectural Lighting
- Stage Lighting

■ Table of Contents

General Information & Product Nomenclature.....	P.2
Optical Specifications	P.3
Mechanical Specifications	P.4
Package Specifications	P.5

LL01CR-BCQxxL06

General Information

- Lens Material Optical Grade PMMA
- Operating Temperature range -40°C~+70°C(upper limit +80°C)
- Storage Temperature range -40°C~+70°C(upper limit +80°C)
 - * Average transmittance in visible spectrum 400nm~700nm>90%
- Usage and Maintenance:
 1. If necessary, clean lenses with mild soap, water and soft cloth.
 2. Never use any commercial cleaning solvents on lenses, like alcohol.
 3. Please handle or install lenses with wearing gloves, skin oils may damage lens or its optical characteristic.

Product Nomenclature

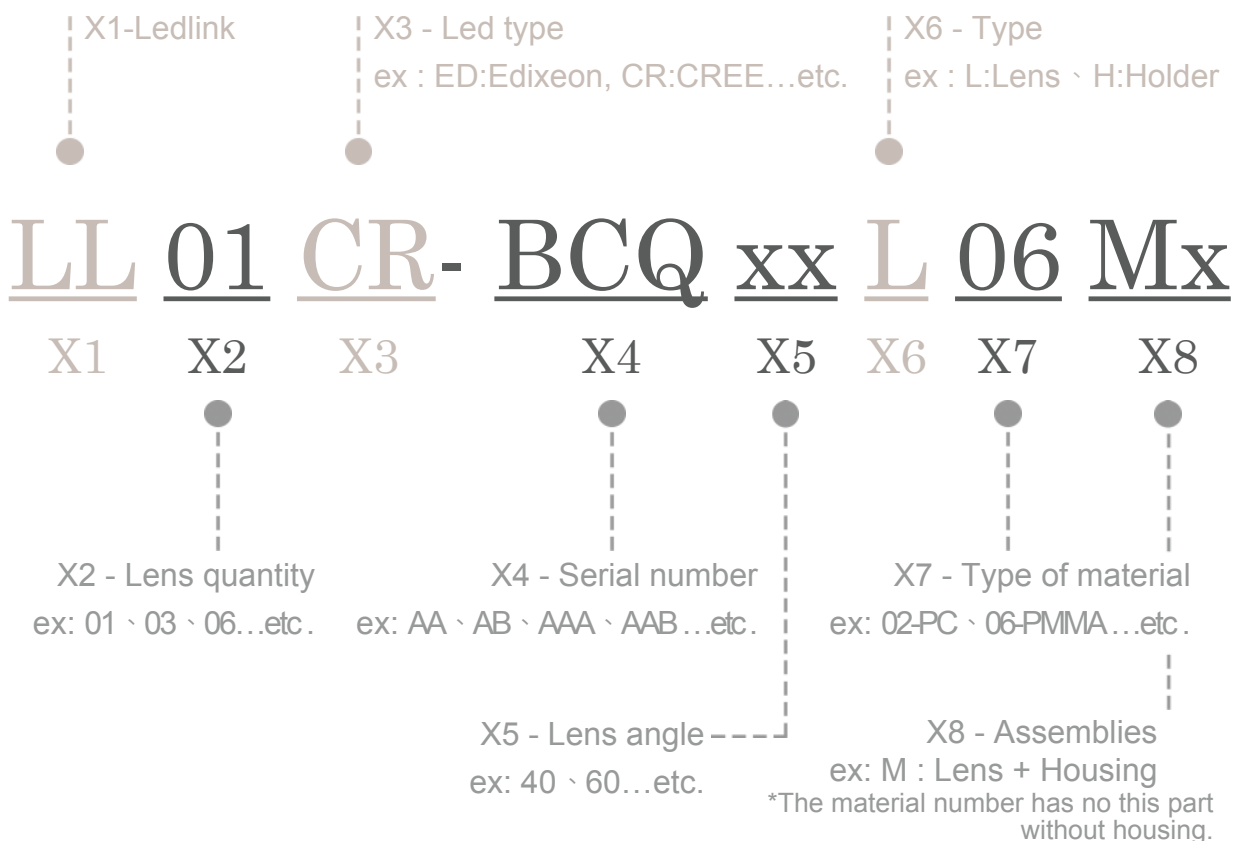



LL01CR-BCQxxL06

Optical Specifications

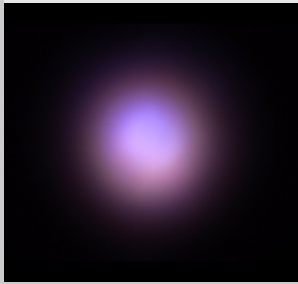
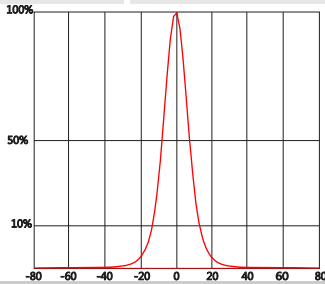
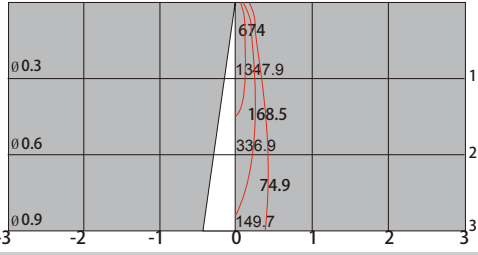

MC-E(RGBW)

Note: (1) All the results of analysis are based on 0 degrees of elevation.
 (2) Tolerance: $\pm 10\%$.
 (3) Led Luminous Flux(lm): 204($\pm 5\%$).

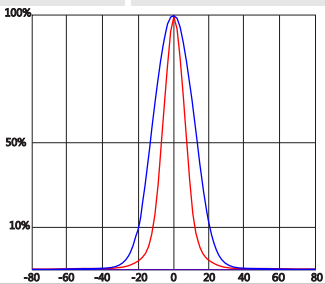
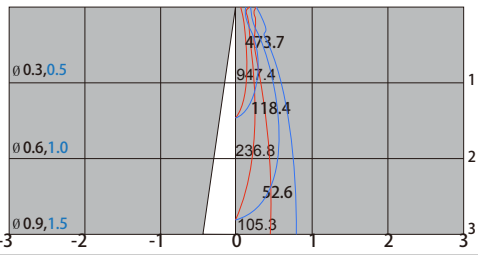
Part Number	FWHM	Field Angle*	cd / lm	IES File
LL01CR-BCQ15L06	18°	35°	6.6	Download
				
Beam Pattern	Light Distribution Curve		Illuminance Distribution	
Part Number	FWHM	Field Angle*	cd / lm	IES File
LL01CR-BCQ1530L06	16°/30°	32°/51°	4.6	Download
				
Beam Pattern	Light Distribution Curve		Illuminance Distribution	

*The Field Angle is the angle between the two directions opposed to each other over the beam axis for which the luminous intensity is 10% that of the maximum luminous intensity.
 *This testing result is obtained through testing the popular rank LED samples which provided by the original manufacturer. Hence, the testing results would be varied as the users choose same LED model but different rank.

LL01CR-BCQxxL06

Mechanical Specification

1. Fixing method

- Glue
 Screw
 Tape
 Fixing-ring
 Frame

Note: (1) All dimensions are in mm.
 (2) All measurements are ± 0.15 mm unless otherwise indicated.

2. Lens dimensions

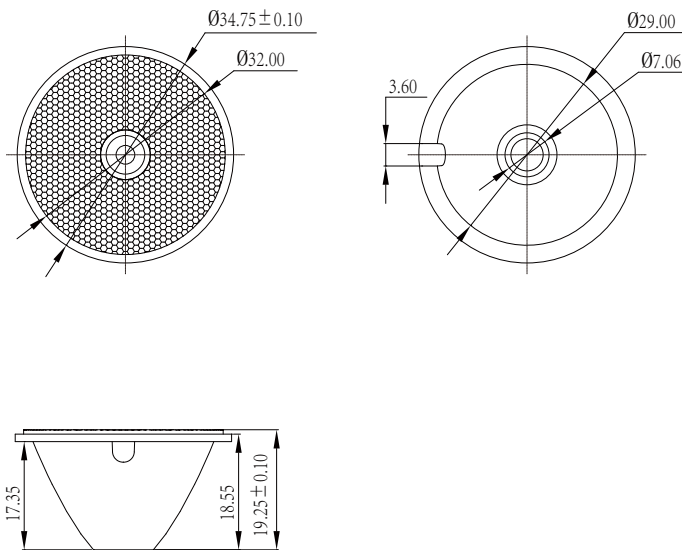

3. Lens + Leds + MCPCB assembly instruction

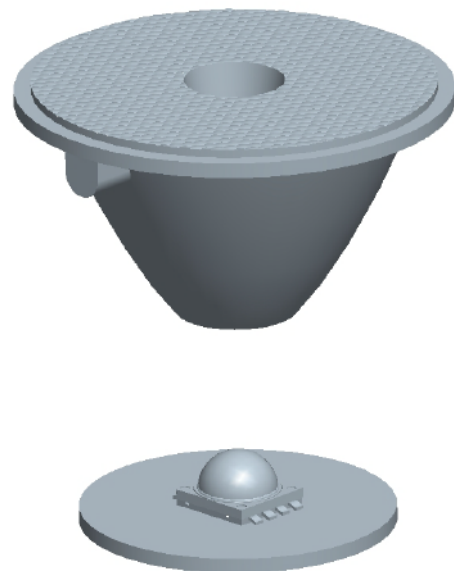

4. Lens assembly dimensions

5. View assembly lens with MCPCB:

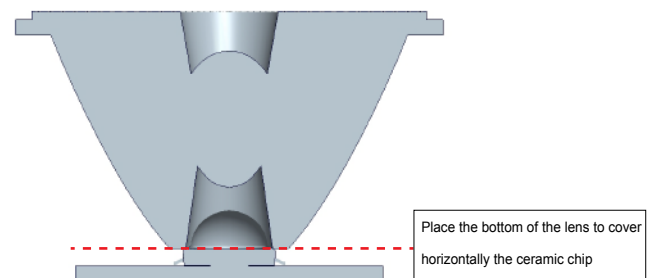

LL01CR-BCQxxL06

Package Specifications

Item	Quantity	Total	Size(L*W*H)	G.W
Plastic box	63 pcs/plastic box	63 pcs	33*30*2 cm	
Outer box	9 plastic box/Outer box	567 pcs	40*37*21 cm	8.8g

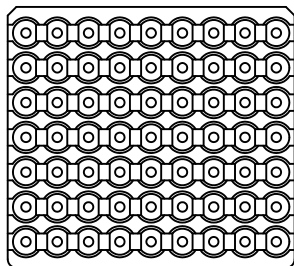

63 pcs/plastic box

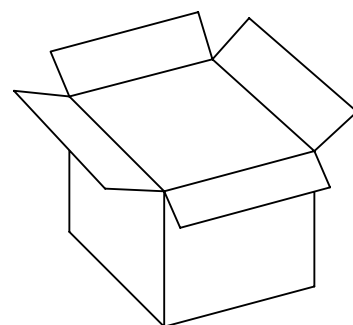
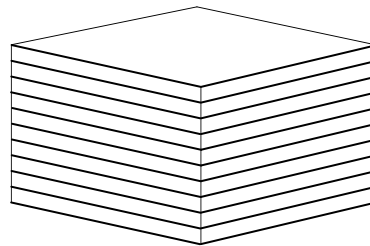

567 pcs/Outer box



Note: