

# Data Sheet

## LL01CR-ABHxxL02



### ■ Features & Typical Applications

- High efficiency
- Available with 2 beam angles
- Optimized Uniformity
- Lens without Holder
- Architectural Lighting
- Commercial Lighting

### ■ Table of Contents

General Information & Product Nomenclature.....	P.2
Optical Specifications .....	P.3
Mechanical Specifications.....	P.4
Package Specifications.....	P.5

# LL01CR-ABHxxL02

## General Information

- Lens Material : PC LEV1700
- Operating Temperature range -40°C~+110°C(upper limit +120°C).
- Storage Temperature range -40°C~+110°C(upper limit +120°C).
  - \* Average transmittance in visible spectrum 400nm~700nm>90%.
- Usage and Maintenance:
  1. If necessary, clean lenses with mild soap, water and soft cloth.
  2. Never use any commercial cleaning solvents on lenses, like alcohol.
  3. Please handle or install lenses with wearing gloves, skin oils may damage lens or its optical characteristic.

## Product Nomenclature

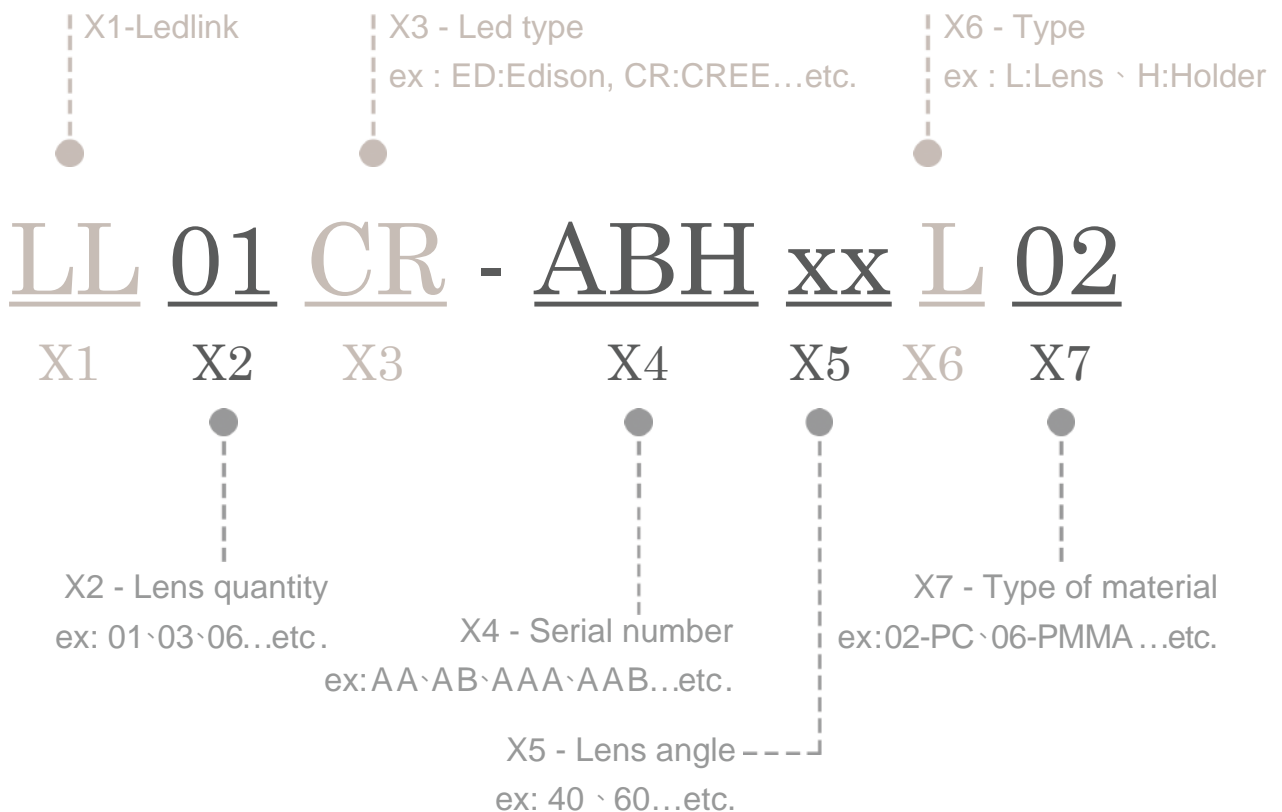

# LL01CR-ABHxxL02 Optical Specifications



**ZC4**

Note: (1) All the results of analysis are based on 0 degrees of elevation.  
 (2) Tolerance:  $\pm 10\%$ .  
 (3) Led Luminous Flux(lm): 440( $\pm 5\%$ ).

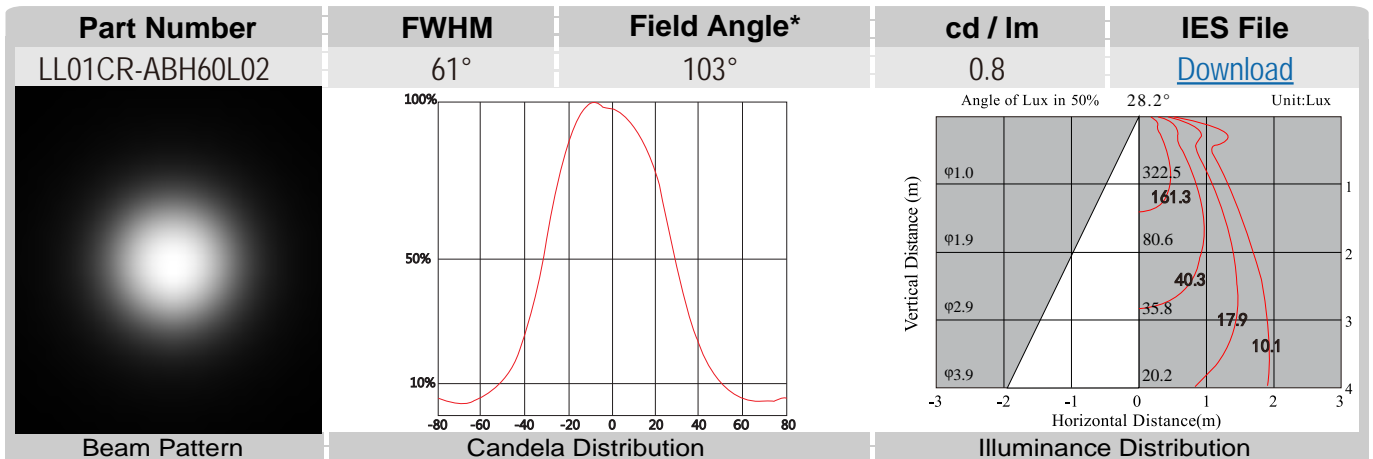
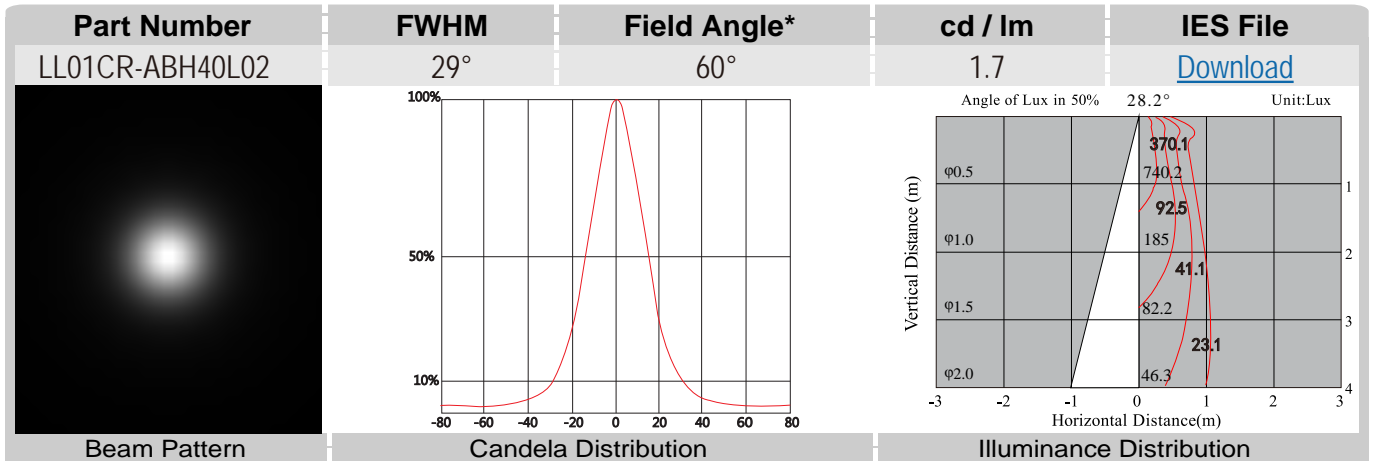

\*The Field Angle is the angle between the two directions opposed to each other over the beam axis for which the luminous intensity is 10% that of the maximum luminous intensity.  
 \*This testing result is obtained through testing the popular rank LED samples which provided by the original manufacturer. Hence, the testing results would be varied as the users choose same LED model but different rank.

# LL01CR-ABHxxL02 Mechanical Specification

## 1. Fixing method

- Glue     
  Screw     
  Tape     
  Fixing-ring     
  Frame

Note: (1) All dimensions are in mm.  
 (2) All tolerance are  $\pm 0.15$  mm unless otherwise specified.

## 2. Lens dimension

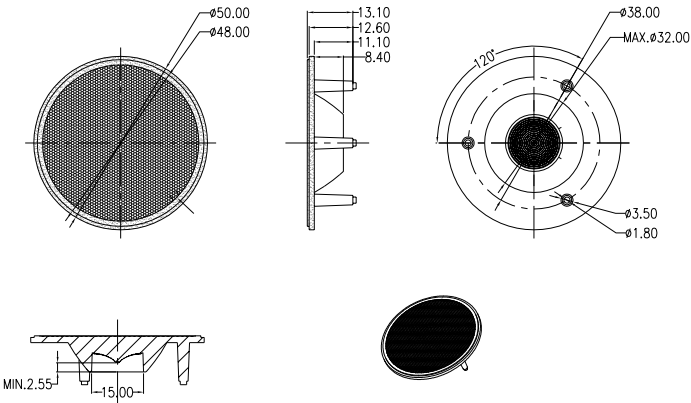

## 3. Lens + Leds assembly instruction



## 4. Connector dimension

## 5. View assembly lens with LED:

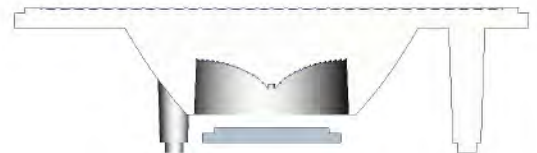

# LL01CR-ABHxxL02 Package Specifications

Item	Quantity	Total	Size(L*W*H)	G.W
plastic box	25 pcs/plastic box	25 pcs	32.8*29.8*1.6 cm	7.5g
outer box	13 plastic box/outer box	325 pcs	35*31*21 cm	

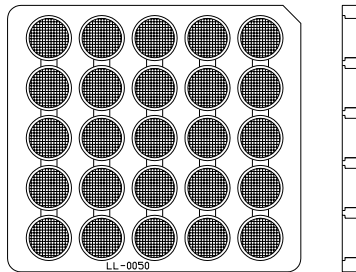

25 pcs/plastic box

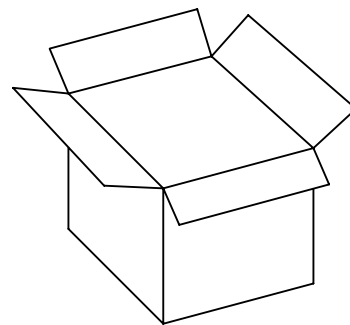
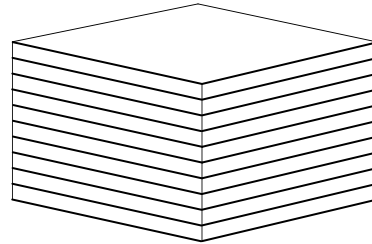

325 pcs/outer box



Note: