

PLL2174UW - 90° FWHM

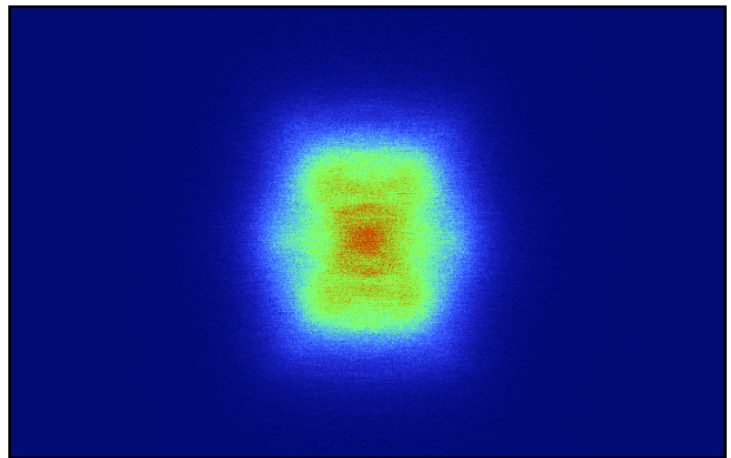
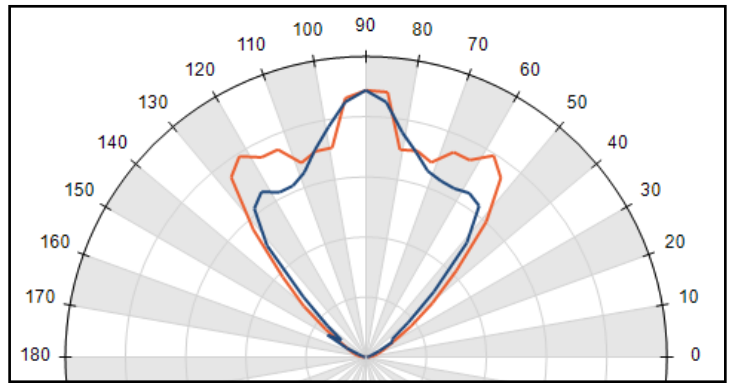

- Material = PMMA Clear - **Non-yellowing, 10-year guarantee****
- Full angle C0-C180 at 50% from maximum: ~ 90°
- Full angle C0-C180 at 10% from maximum: ~ 120°
- The light spots here represented refer to tests carried out with 24 LEDs, 0.9 Watt, 3030 size, ~ 3432lm@Strip

Note:

- Dimensions in inches into brackets
- For missing dimensions see 3D file
- WHITE surfaces mirror polished
- GREY surfaces embossed 25/27 VDI
- ORANGE surfaces embossed 22 VDI
- RED surfaces max available area for gate material
- Gate will be removed by laser plotter: sink mark injection will be present
- 1 *** ORANGE SURFACES: NONE EJECTOR CAN BE PLACED ON THOSE AREAS ***
- Planarity tolerance +/- 0.8 mm
- © = Quality Control Dimension (QCD)

Technical Drawing Details:

- Top View: Shows lens array with dimensions like 99.5 (3.681) and 110 (4.331).
- Side View: Shows profile with gate height 208.8 (8.22) and 69.6 (2.74).
- Cross-section: Shows lens and substrate with dimensions like 43 (1.693) and 31 (1.221).

Table:

DESCRIPTION: Linear lens array		DESIGNER: LM/LS	PRODUCT: PLL2174KX
CODE: PLL 2174 UW	Checked: LM/LS	CONTROLLED: GV/LS	DATA: 03/12/2018
Khatod Via Alessandrina, 25 Cusano Milanese Milano ITALIA WWW.KHATOD.COM		General Tolerances: +/- 0.20 mm	HEAT TREATMENT: None MATERIAL: PMMA 8N SCALE: 1 : 1 SHEET: 1 of 1

Assembly Specifications

PLL2174xx Lens

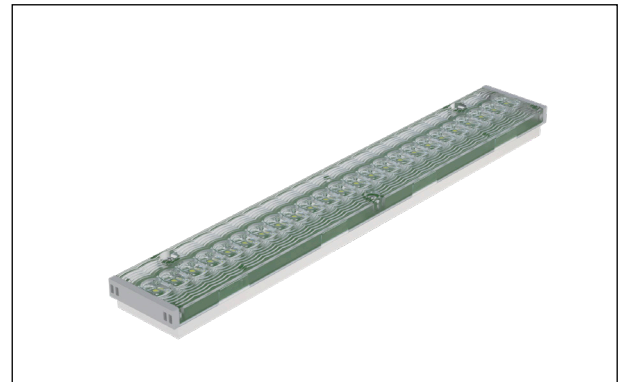
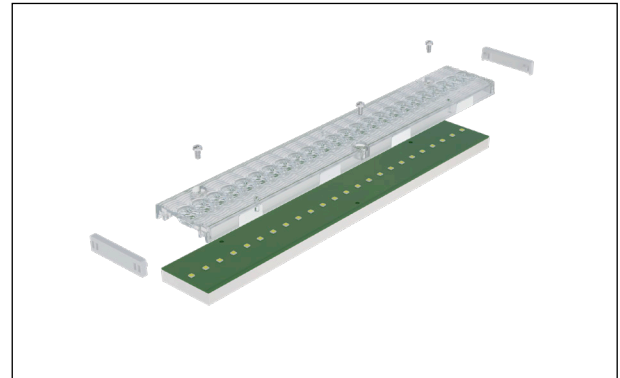
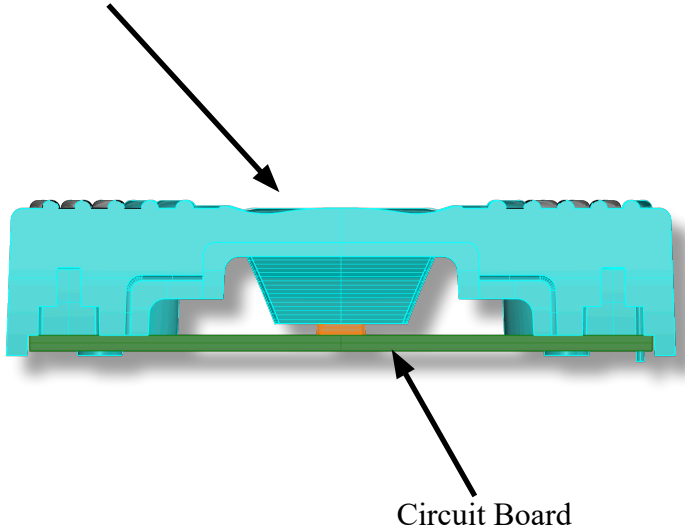

Use TCEI M4 screws

- M4: Maximum tightening torque ~ 0.9 Nm

K2174P - Plastic End Plugs

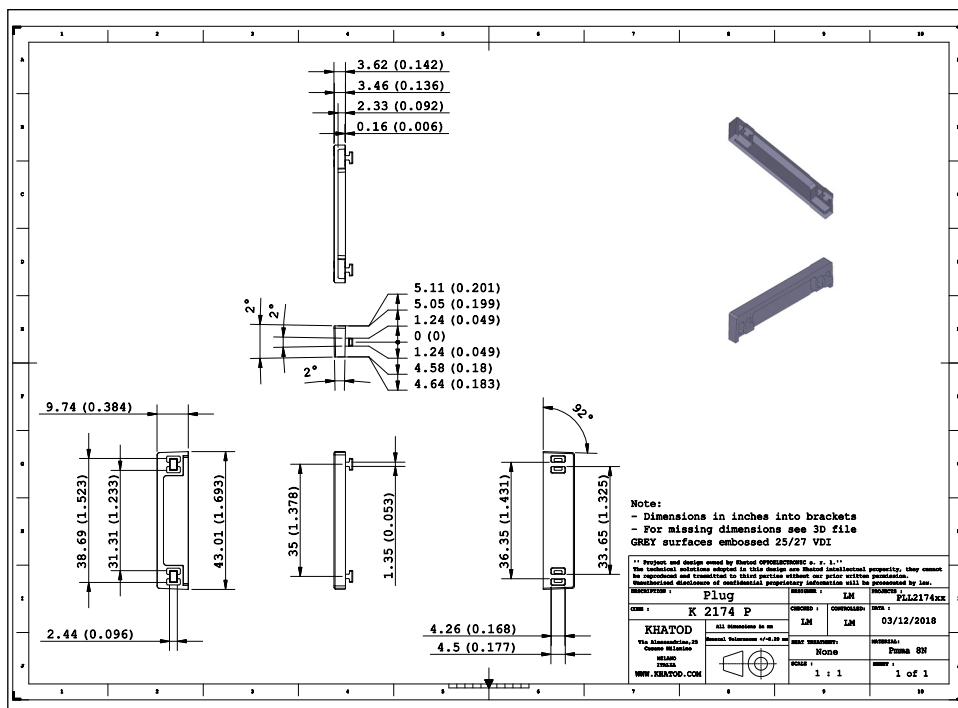

Packaging

Item	Quantity	Total Parts	Size (L*W*H)	G.W.
Multi-pocket plastic bag	20 pieces per multi-pocket plastic bag	20 pcs	110*40 cm	0.8 Kg
Outer Box	13 multi-pocket plastic bags per Outer Box	260 pcs	50*32*38 cm	15.5 Kg



260 Modules / Multi-pocket plastic bags

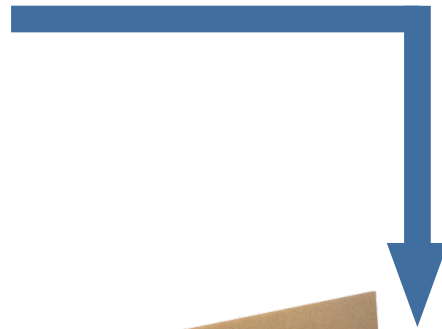

13 Multi-pocket plastic bags per Outer Box

Materials

Material	Top
PMMA 8N **	-40°...90°C
For further information please visit Evonik website	

**

PLL2174xx Series is made of the same material used to produce PLEXIGLAS® Solar which guarantees it will show no yellowing for 10 years.

Yellowness Index (YI) according to the test standards for Arizona/Florida outdoor exposure testing:

- YI 6 under hot/dry conditions
- YI 8 under hot/wet conditions

Notes:

- Intensity (I) and illuminance (E) data are normalized by 1000 lm
- The optical values shown are the result of optical simulations carried out with LIGHTTOOLS, ASAP and ZEMAX software systems. The optical simulations are carried out on the basis of the typical values provided in the LED manufacturers' official datasheets. The photometric analysis has been carried out on physical samples. On request, by supplying your PCB, we can provide the measurement photometric file.

Use and Maintenance

- DO NOT HANDLE OR INSTALL LENSES WITHOUT WEARING GLOVES, SKIN OILS MAY DAMAGE LENS OR LIGHT TRANSMISSION;
- CLEAN LENSES WITH MILD SOAP AND WATER AND A SOFT CLOTH;
- DO NOT USE ANY COMMERCIAL CLEANING SOLVENTS ON LENSES.

Disclaimer

Please note that flow lines and weld lines on the external surfaces of the lenses are acceptable if the optical performance of the lens is within the specifications.

Should you require further information, please contact Khatod for advice. All lens testing must be subject to identical conditions as Khatod test condition. Khatod Optoelectronic, Milan, Italy, manufactures lenses for LEDs. Any other use of the lens shall void our liability and warranty. The lenses are an inert component to be used in the manufacture of various products. Our warranty and liability are limited only to the manufacture of the lens. You may not modify, copy, distribute reproduce, license or alter the lens and related materials of Khatod. Khatod does not warrant against damages or defects arising out of the use or misuse of the products; against defects or damage arising from improper installation, or against defects in the product or in its components. No warranty of any kind, expressed or implied, is made regarding the safety of the products. The entire risk as to the quality or performance of the product is with the buyer. In no event shall Khatod be liable for any direct, indirect, punitive, incidental, special, consequential damages, or any damages whatsoever arising out of or connected with the use or misuse of the product. Khatod shall not have any obligation with respect to the product or any part thereof, whether based on contract, tort, strict liability or otherwise. Buyer assumes all risks and liability from use of the product. The laws of Milan, Italy govern this product warranty and liability and you hereby consent to the exclusive jurisdiction and venue of courts in Milan, Italy in all disputes arising out of or relating to the use of this product. Production, marketing, distribution, sale of these products as well as their possible modifications and variations are only exclusive right of Khatod Optoelectronic. No company can perform any of these actions without written permission released by Khatod Optoelectronic. The information contained in this document is proprietary of Khatod Optoelectronic and may change without notice.

REPRODUCTION PROHIBITED.