

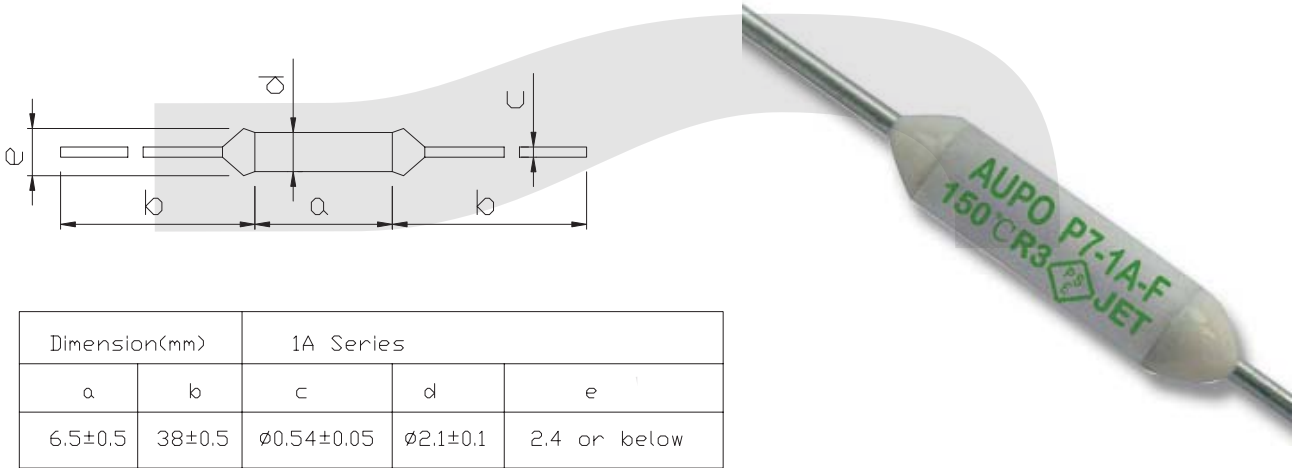

Thermal Fuse Series

KLS5-105 Porcelain tube Thermal Fuse 1A Series



Dimension(mm)		1A Series		
a	b	c	d	e
6.5±0.5	38±0.5	∅0.54±0.05	∅2.1±0.1	2.4 or below

Rated functioning temperature(Tf): The temperature at which a Thermal Cutoff changes its state of conductivity to open circuit detection current. The tolerance according to IEC60691 is from -10°C~+0°C .(With Japan Electrical Appliance and Material Law, on the other hand, they must function in the tolerance range of ±7°C).

Fusing(cut)-off temperature: The fusing-off temperature indicates value measured in silicon oil with a temperature increased by 0.5-1°C per minute and a detective current 100mA or less.

Holding temperature(Th): The maximum temperature at which a thermal Cutoff will not cause a change in state of conductivity to open circuit while conducting rated current for 168 hours. This rating is required by safety standards based on IEC60691.

Maximum temperature limit(Tm): The maximum temperature at which a Thermal Cutoff can be maintained for 10 minutes without reclosing. This rating is required by safety standards based on IEC60691.

Rated current(Ir): The allowable maximum current which a Thermal Cutoff is able to carry.

Rated voltage(Ur): The allowable maximum voltage which a Thermal Cutoff is able to be applied.

ORDER INFORMATION

Product No.: KLS5- 105 - 1A X

Part Number

Porcelain tube Thermal Fuse Series

Rated Current

Rated functioning temp

Fuse holder Series

KLS5-105 Porcelain tube Thermal Fuse 1A Series



105-1A Series													
Model No.	Rated Functioning temp.	Fusing-off temperature	Holding temperature (Th)	Maximum temp. limit	Rated current	Rated voltage (Ur)	Safety approval						RoHS Compliance
	(Tf)						(Tm)	(Ir)	UL	CUL	VDE	PSE	
1A115	115°C	112±3°C	85°C	180°C	1A	250Vac	●	●	●	●	●	●	●
1A125	125°C	120±3°C	97°C	180°C	1A	250Vac	●	●	●	●	●	●	●
1A130	130°C	126±2°C	102°C	180°C	1A	250Vac	●	●	●	●	●	●	●
1A135	135°C	131±3°C	105°C	180°C	1A	250Vac	●	●	●	●	●	●	●
1A138	138°C	135±2°C	108°C	180°C	1A	250Vac	●	●	●	●	●	●	●
1A150	150°C	145±3°C	120°C	180°C	1A	250Vac	●	●	●	●	●	●	●



ORDER INFORMATION

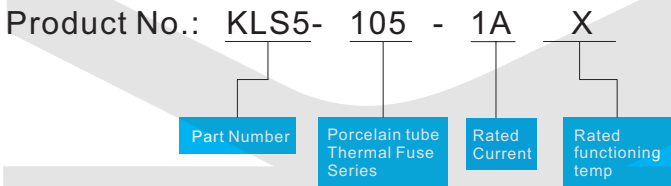

All specification & dimensions are subject to change, please call your nearest KLS sales representative for update information

Thermal Fuse Series

KLS5-105 Porcelain tube Thermal Fuse 2A Series

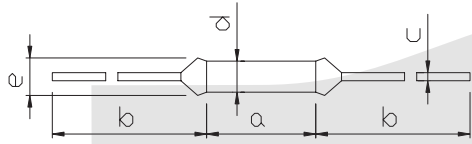

Dimension:(mm)		2A Series		
a	b	c	d	e
9.0±0.5	38±3	∅0.54±0.05	∅2.5±0.1	3.3 or below

105-2A Series													
Model No	Rated functioning temp	Fusing-off temperature	Holding temperature (Th)	Maximum temp. limit	Rated current (Ir)	Rated voltage	Safety approval						RoHS Compliance
	(Tf)			(Tm)			UL	CUL	VDE	PSE	CCC	EK	
2A115	115°C	112±3°C	85°C	180°C	2A	250Vac	●	●	●	●	●	●	●
2A125	125°C	120±3°C	97°C	180°C	2A	250Vac	●	●	●	●	●	●	●
2A130	130°C	126±2°C	102°C	180°C	2A	250Vac	●	●	●	●	●	●	●
2A135	135°C	131±3°C	105°C	180°C	2A	250Vac	●	●	●	●	●	●	●
2A138	138°C	135±2°C	108°C	180°C	2A	250Vac	●	●	●	●	●	●	●
2A150	150°C	145±3°C	120°C	180°C	2A	250Vac	●	●	●	●	●	●	●

ORDER INFORMATION

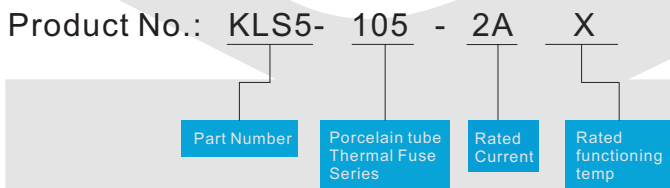

FUSE AND FUSE HOLDER

Thermal Fuse Series

KLS5-105 Porcelain tube Thermal Fuse 3A Series

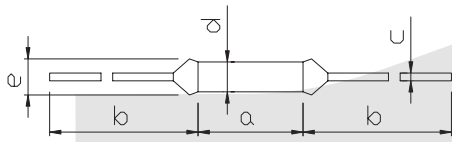

Dimension:(mm)		3A Series		
a	b	c	d	e
10.0±0.5	38±3	∅0.6±0.05	∅3.0±0.1	3.3 or below

105-3A Series												
Model No	Rated functioning temp	Fusing-off temperature	Holding temperature (Th)	Maximum temp. limit (Tm)	Rated current (Ir)	Rated voltage (Ur)	Safety approval					RoHS Compliance
	(Tf)						UL	CUL	VDE	PSE	CCC	
3A084	84°C	82±2°C	55°C	180°C	3A	250Vac	●	●	●	●	●	●
3A115	115°C	112±3°C	75°C	180°C	3A	250Vac	●	●	●	●	●	●
3A125	125°C	120±3°C	85°C	180°C	3A	250Vac	●	●	●	●	●	●
3A130	130°C	126±2°C	90°C	180°C	3A	250Vac	●	●	●	●	●	●
3A135	135°C	131±3°C	90°C	180°C	3A	250Vac	●	●	●	●	●	●
3A138	138°C	135±2°C	95°C	180°C	3A	250Vac	●	●	●	●	●	●
3A150	150°C	145±3°C	105°C	180°C	3A	250Vac	●	●	●	●	●	●

ORDER INFORMATION

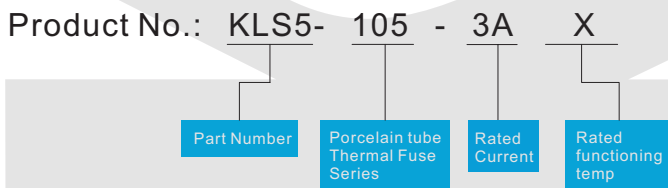

Thermal Fuse Series

KLS5-105 Porcelain tube Thermal Fuse 5A Series

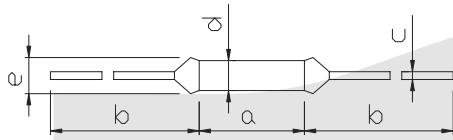

Dimension:(mm)		5A Series		
a	b	c	d	e
11.5±0.5	38±3	∅0.6±0.02	∅3.3±0.2	3.6 or below



105-5A Series												
Model No	Rated functioning temp	Fusing-off temperature	Holding temperature (Th)	Maximum temp. limit (Tm)	Rated current (Ir)	Rated voltage (Ur)	Safety approval					RoHS Compliance
	(Tf)						UL	CUL	VDE	PSE	CCC	
5A084	84°C	82±2°C	55°C	180°C	5A	250Vac	●	●	●	●	●	●
5A115	115°C	112±3°C	75°C	180°C	5A	250Vac	●	●	●	●	●	●
5A125	125°C	120±3°C	85°C	180°C	5A	250Vac	●	●	●	●	●	●
5A130	130°C	126±2°C	90°C	180°C	5A	250Vac	●	●	●	●	●	●
5A135	135°C	131±3°C	90°C	180°C	5A	250Vac	●	●	●	●	●	●
5A138	138°C	135±2°C	95°C	180°C	5A	250Vac	●	●	●	●	●	●
5A150	150°C	145±3°C	105°C	180°C	5A	250Vac	●	●	●	●	●	●

ORDER INFORMATION

Product No.: KLS5- 105 - 5A X

