

GNT-3631Ax-Bx (TRIPLE DIGIT LED DISPLAY)

GNT-3631 Series

GNT-3631Ax

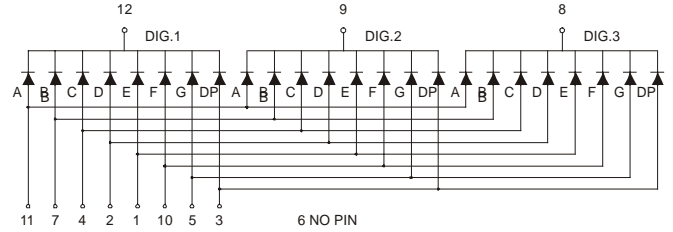
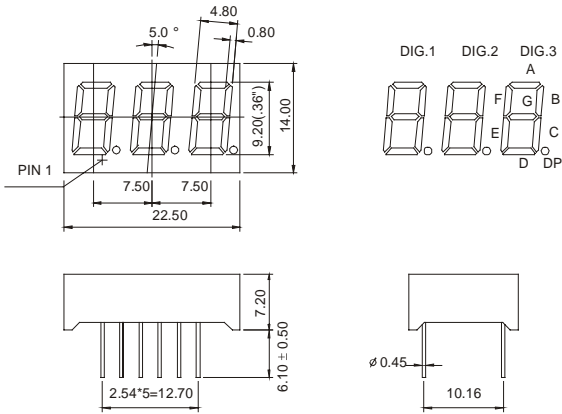

GNT-3631Bx

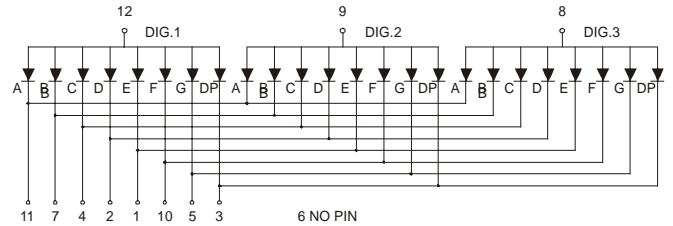

Features:

*0.36 INCH HIGH CHARACTER.

*EXCELLENT CHARACTER APPEARANCE.

*COMMON CATHODE OR COMMON ANODE.

*I.C. COMPATIBLE.

*LOW POWER CONSUMPTION.

Part Number	EMITTED COLOR		Common Cathode or Common Anode	Peak Wavelength (nm)	Vf (v) Typ	If (mA)	Intensity Per Segment (mcd)	
							Min.	Typ.
GNT-3631AE	GaAsP/GaP	Hi. effi Red	Common Cathode	635	2.0	20	9	12
GNT-3631AG	GaP	Green		565	2.1	20	8	11
GNT-3631AY	GaAsP/GaP	Yellow		585	2.0	20	9	12
GNT-3631AS	GaAlAs	Super Red		660	1.8	20	10	13
GNT-3631AD	GaAlAs	Ultra Red		660	1.8	20	25	30
GNT-3631AUE	AlGaInP	Ultra Red		625	2.0	20	30	35
GNT-3631AUY	AlGaInP	Ultra Yellow		590	2.0	20	30	35
GNT-3631BE	GaAsP/GaP	Hi. effi Red	Common Anode	635	2.0	20	9	12
GNT-3631BG	GaP	Green		565	2.1	20	8	11
GNT-3631BY	GaAsP/GaP	Yellow		585	2.0	20	9	12
GNT-3631BS	GaAlAs	Super Red		660	1.8	20	10	13
GNT-3631BD	GaAlAs	Ultra Red		660	1.8	20	25	30
GNT-3631BUE	AlGaInP	Ultra Red		625	2.0	20	30	35
GNT-3631BUY	AlGaInP	Ultra Yellow		590	2.0	20	30	35