

60W Constant Current -FMS Series

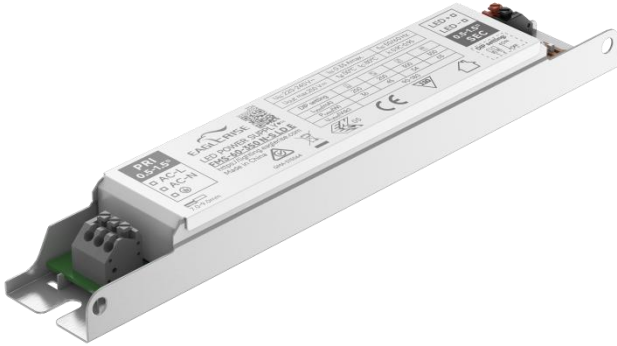

■ Approve



Features

- Class I , Non-isolated, Built-in
- Input Voltage :220-240VAC
- Protections: SCP/OVP/OTP
- Power Factor: 0.95(Typ.)
- Efficiency: ≥90% (Typ.)
- Adjustable Output Current with dip-switch
- 5 years warranty
- IP20

Applications

- Linear light

◆ Description

FMS-60-350 N-S LD E is a 60W constant current LED driver that operates from 198-264Vac input with 200 to 350mA output current. The output current is adjustable by DIP Switch. With it's dimensions from 190 x 30 x 21mm. It is easy to integrate in linear light products.To ensure trouble-free operation, protection is provided against output short circuit, over voltage and over temperature.

◆ Model code

FMS-60-350 N-S LD E

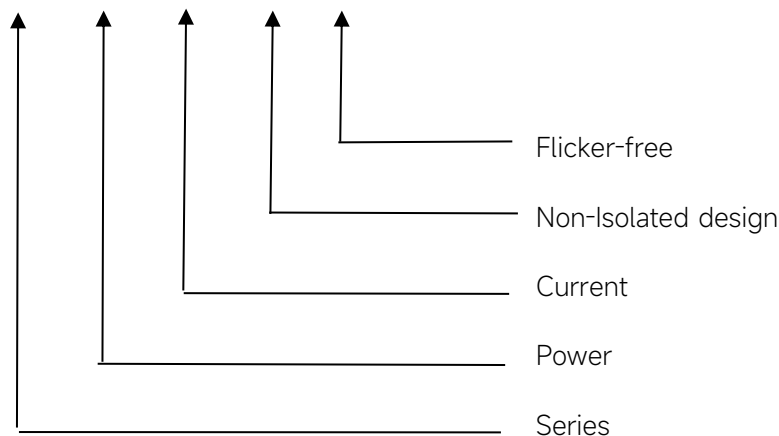

◆ Specification

	Constant Current	200mA	250mA	300mA	350mA
Output	Voltage Range	90-180VDC			
	Unload voltage Max.	250VDC			
	Current Accuracy	±7%	±5%		
	Output HF current ripple(≥1KHz)	±5%			
	Output LF current ripple(≤120Hz)	±5%			
	SVM	≤0.4			
	Pst	≤1			
	Efficiency(Typ.)	≥90% @Full load ,220-240V			
	Input	Rated input voltage	220-240VAC		
Range of input voltage		198-264VAC			
Range of input DC voltage(VDC)		176-280VDC			
Frequency(Hz)		0/50/60 Hz			
Displacement factor		≥0.7			
Power Factor		≥0.95 @Full load ,220-240V			
Input Current max		0.35A			
Start-up time		< 0.5S			
No Load Power		≤0.5W			
THD (Typ.)		<10%@Full load ,220-240V			
Protection		Over Voltage Protection	YES/Auto Resume		
	Short circuit Protection	YES/Auto Resume			
	Over Temperature Protection	YES/Auto Resume Ta≥75° C, reducing the output current			
Environment	Operating Temperature	-20°C~+50°C			
	Humidity	20%-90%RH			
	Tc	80°C			
	Storage Temperature	-25°C~+60°C			
	Life time	> 50000h@Tc=80°C,230VAC			
	Ripple & Noise	≤20dB(A)@20cm			
Surface	Dimension	190X30X21(LXWXH)mm			
Standards	IEC61347- 1, IEC61347-2- 13; EN61347- 1, EN61347-2- 13; EN61347- 1, EN61347-2- 13, EN62384; GB/T17743, GB17625. 1, GB19510. 1, GB19510. 14; EN55015, EN61000-3-2, EN61000-3-3, EN61547				
Others	ErP	EU 2019/2020			
	RoHS	RoHS (2011/65/EU) (EU)2015/863			
Note	1.All parameters not specially mentioned are measured at 230VAC input, full load and 25°C of ambient temperature. 2.Ripple & Noise are measured at 20MHz of bandwidth by using a 300mm twisted pair-wire terminated with a 0.1uF & 47 uF parallel capacitor. 3.Switch and dimmer are not recommended to connect between this product output and luminaries.				

◆ Parameter

Number	Output				Switch position	
	Current (mA)	Voltage (VDC)	Voltage No load (VDC)	Power (W)	1	2
1	200mA	90-180	250	36W	--	--
2	250mA			45W	ON	--
3	300mA			54W	--	ON
*4	350mA			63W	ON	ON

* Factory default

◆ Circuit Breaker

I _{peak}	T _{width}	B10	B16	B20	C10	C16	C20
32.4A	240μs	10pcs	16pcs	20pcs	17pcs	27pcs	34pcs

◆ Wiring diagram

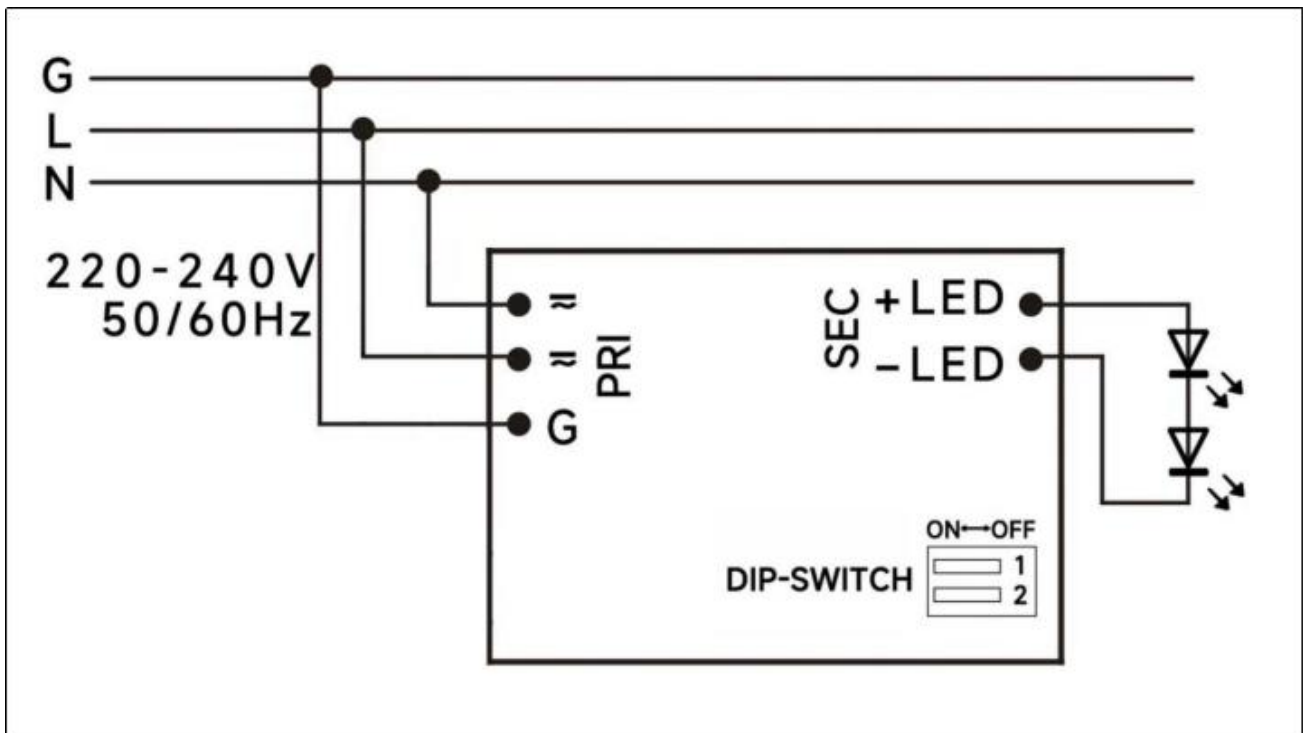

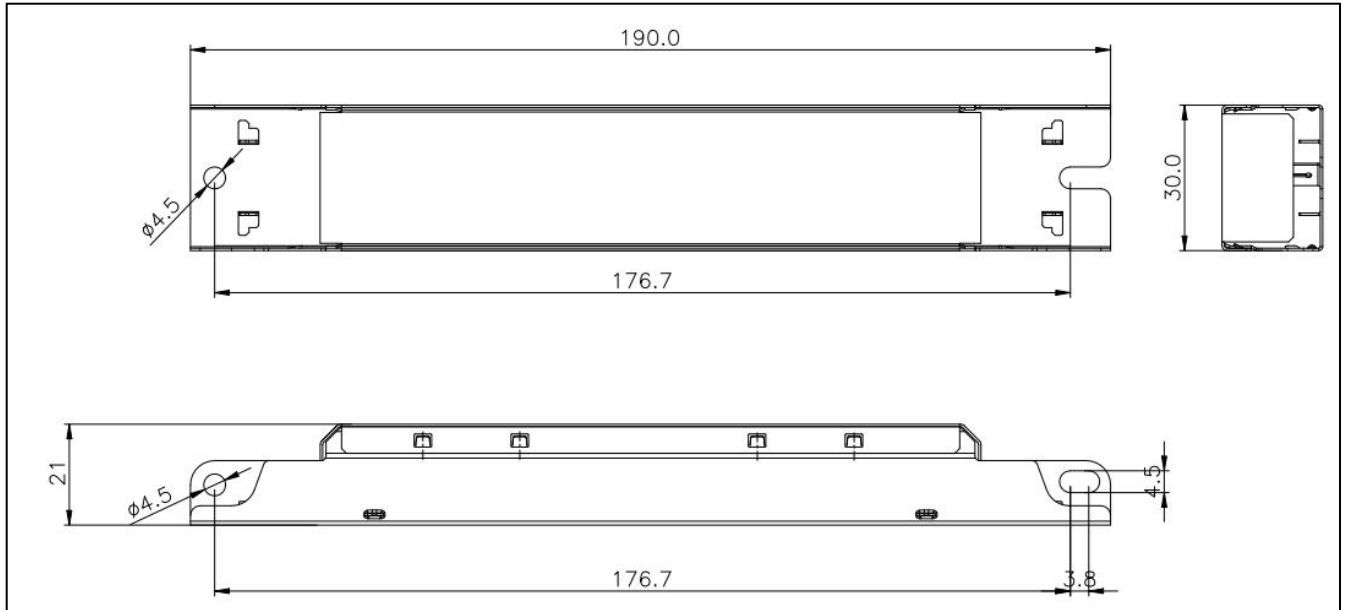
◆ 2D diagram

◆ Wiring & Connections

Specification item		Value (Unit)
Input	Input wire cross-section	0.5...1.5 mm ²
	Input wire gauge.	16...20 AWG
	Input wire strip length	7...9mm
Output	Output wire cross-section	0.5...1.5 mm ²
	Output wire gauge.	16...20 AWG
	Output wire strip length	7...9mm

◆ Curve for FMS-60-350 N-S LD E, $I_o=350mA$

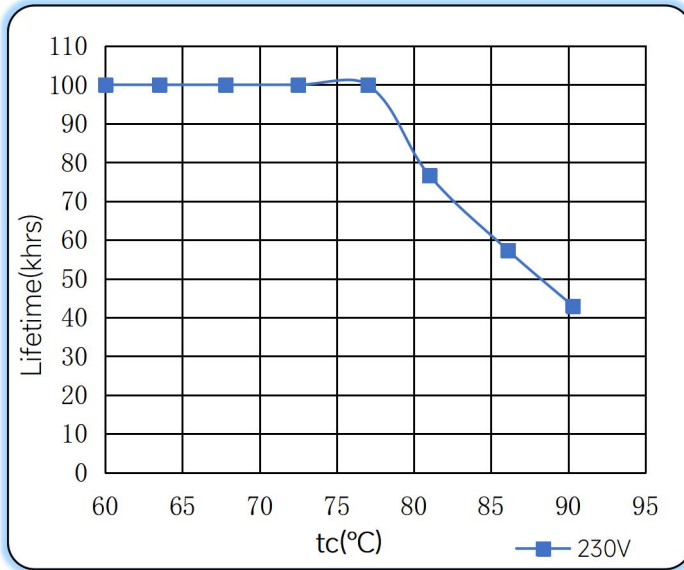
Lifetime vs. Temperature Curve



Efficiency vs. Load

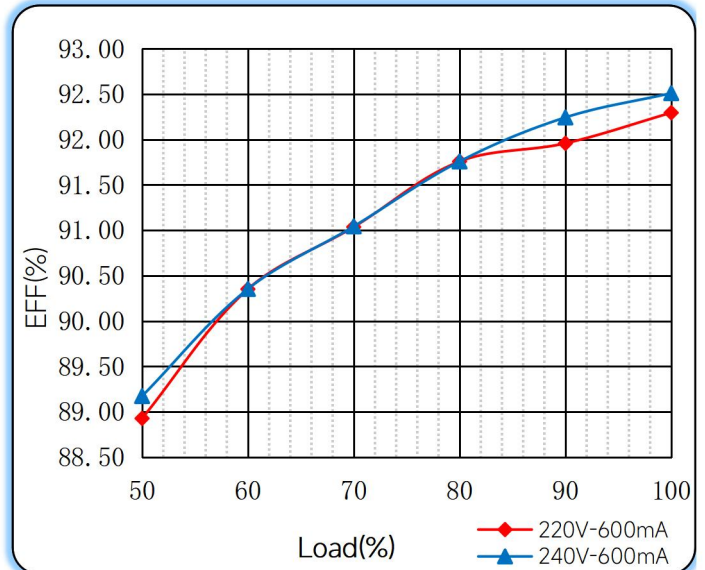

Power Factor Characteristics

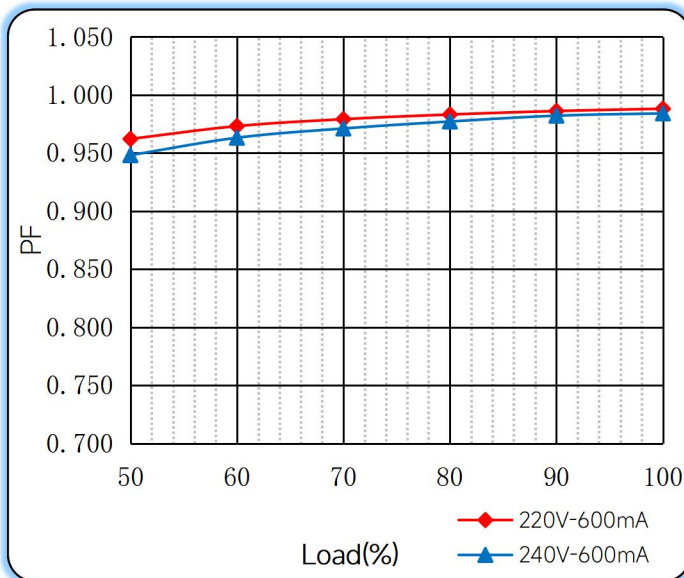

THD vs. Load

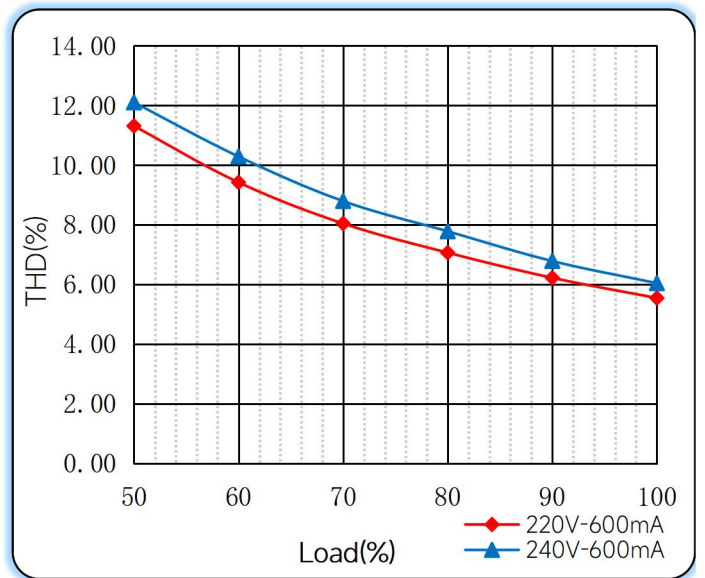

◆ Operating window

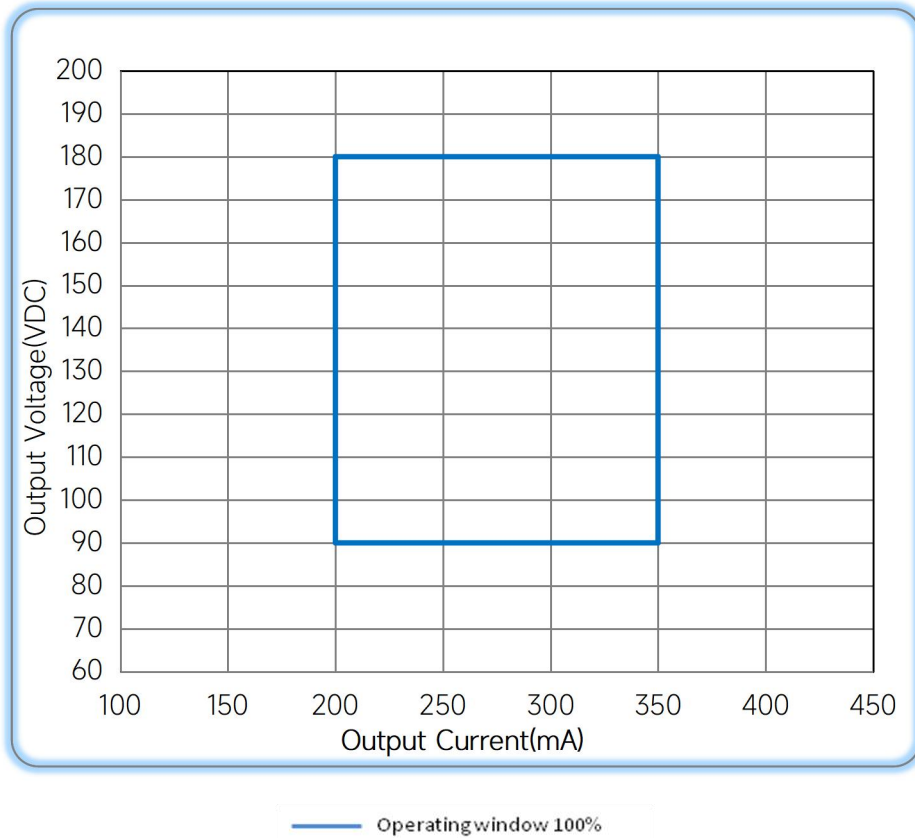

◆ Revision Updates

ITEM	BEFORE	AFTER	VERSION	DATE
Initial			A	2023/01/13
Current Accuracy	±5%	±7%@200mA;±5%@250-350mA;	B	2023/06/15

Tel: +86-0757-86256822, +86-0757-86256831

E-mail: sales@eaglerise.com

Website : <https://lighting.eaglerise.com>



EAGLERISE



Manual