



EZI-Set Compact Round LED Driver

The EZI-Set DCP-END series of compact LED drivers offers a wide range of configurable current setting, flicker-free performance in compact packages for various lighting fixtures, where form factor, quality of light, and high reliability are critical factors.

Product Offering

Power: 17 / 30 W
 Input: 220-240 V (50/60 Hz)
 Output: 275-450 mA | 30-38V (17W)
 450-800 mA | 30-38V (30W)
 IP rating: IP20

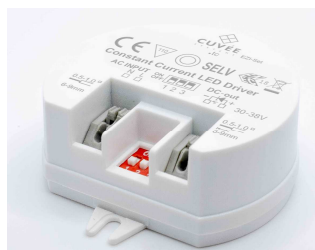

17 / 30W
(∅ 54.2 x 22.5 mm)

Features and Benefits

EZI-Set™	Currents are easy to set with DIP switch settings
Compact Size	Compact packages sized for 2 power level
Flicker Free	World-class flicker free design ensures Percent Flicker less than 3%
5 Year Warranty	Backed by the industry leading warranty of 5 years gives confidence in long term and maintenance free performance



EZI-SET™



COMPACT SIZE



FLICKER FREE



IP RATING



5 YEAR WARRANTY





1 - Input Characteristics

Specification item	Value	Condition
Nominal Input Voltage Range AC	220 – 240 VAC	Performance range
Absolute Input Voltage Range AC	198 – 264 VAC	Safety operational range
Maximum Input Current	0.10 A (17W) 0.15 A (30W)	Full output power @ 230V Input Voltage
Input Frequency	50 / 60 Hz	Performance range
Power Factor with Full Load	> 0.9	Full output power @ 230V Input Voltage
Efficiency	85 % (17W) 89% (30W)	Full load @ 230V Input Voltage
THD with Full Load	< 49 % (17W) < 10% (30W)	Full load @ 230V Input Voltage
Maximum Inrush Current	< 3.0A	At 230 input 25°C cold start at 100% conditions. For more details in the attached graph
No-load Power	< 0.5 W	
Start-up Time	< 0.5s	

2 - Output Characteristics

Specification item	Value	Condition
Rated LED Output Power	8.3 – 17.1W (17W) 13.5 – 30.4W (30W)	
Nominal LED Output Current (3 dip-switch control)	275 – 450 mA (17W) 450 – 800 mA (30W)	@ 275 / 300 / 325 / 350 / 375 / 400 / 425 / 450mA @ 450 / 500 / 550 / 600 / 650 / 700 / 750 / 800mA
LED Output Current Tolerance	±5%	
LED Output Voltage Range DC	30 – 38VDC	
Open Loop (no load) Voltage	< 52VDC	driver will limit the output voltage to <52V if LED load is opened
Output Current Ripple LF	≤ 3%	< 2KHz
Output P _{st} LM	≤ 1.0	
Output SVM	≤ 0.4	





3 - Environmental Conditions

Specification item	Value	Condition
Ambient Temperature (Ta) Range	-20 to 40°C	Higher ambient temperature are possible as long as Tc conforms to the operating case temperature range
Operating Case Temperature (Tc) Range	-20 to 85°C	Case Temperature measured at Tc mark on product
Max. Case Temperature (Tc max)	95°C	Max. temperature measured at Tc mark on product
Storage Temperature	-40 to 85°C	
Relative Humidity	80%	Non-condensing
Lifetime @ Tc max	50,000 hours	At Tc within Operating Case Temperature Range.
Ingress Protection	IP20	

4 - Protection Features

Specification item	Value	Condition
Over Current Protection (OCP)	YES	Automatic recovery
Over Voltage Protection (OVP)	YES	Automatic recovery
Output Short-Circuit Protection (SCP)	YES	Automatic recovery



5 - Outline Drawing

5.1a - Outline Drawing DCP-END017/1-PC450-38, DCP-END030/1-PC800-38

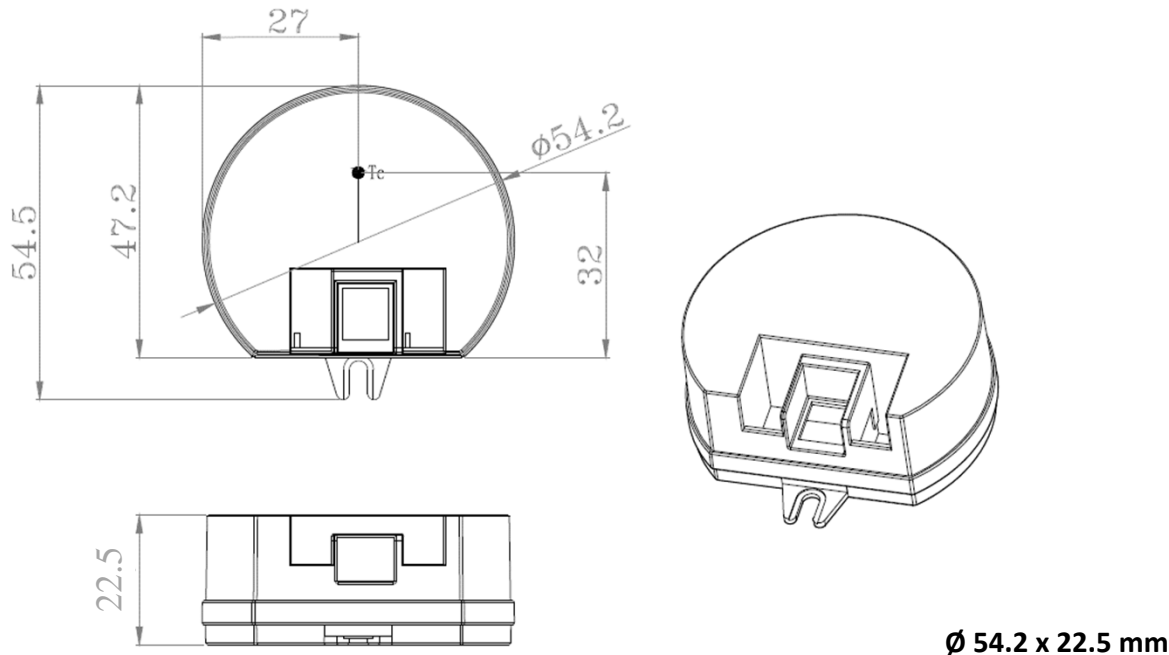

5.1b - Mechanical Details

Specification item	Value	Condition
Length (L)	54.5 mm	
Width (W)	54.2 mm	
Height (H)	22.5 mm	
Weight	58 g (17W) 67 g (30W)	

5.1c - Wiring and Conditions

Specification item	Value	Condition
Output Connections (Poke-in Connector)	Ø 0.5 – 1.5 mm (20 – 16 AWG)	Solid / strand wire
Output Wire Strip Length	6 – 9 mm	
Max. Output Wire Length	20 cm	Total length of wiring





6 - EMC Compliance Approvals

Specification item	Value	Condition
Conducted and Radiated EMI	EN 55015:2019+A11:2020	
Harmonic Current Emissions	IEC 61000-3-2:2019	For Class C equipment
Voltage Fluctuations & Flicker	IEC 61000-3-3:2013+A1:2019	
ESD (Electrostatic Discharge)	IEC 61547 Section 5.2 Test des.: IEC 61000-4-2	4 kV contact discharge, 8 kV air discharge, level 3
Continuous Radiated Disturbance	IEC 61547 Section 5.3 Test des.: IEC 61000-4-3	3 V/m, 80 - 1000 MHz, Modulation @ 1KHz, 80% AM
Electrical Fast Transient	IEC 61547 Section 5.5 Test des.: IEC 61000-4-4	± 1 kV on AC power port for 1 minute
Surge	IEC 61547 Section 5.7 Test des.: IEC 61000-4-5	± 1 kV line to line (differential mode), ±2kV for line to line (common mode)
Continuous Conducted Disturbance	IEC 61547 Section 5.6 Test des.: IEC 61000-4-6	3V, 0.15-80 MHz, Modulation @ 1KHz, 80% AM, 150Ω
Power Frequency Magnetic Field	IEC 61547 Section 5.4 Test des.: IEC 61000-4-8	3A/m, 50/60Hz, level 2
Voltage Dips	IEC 61547 Section 5.8, 5.9 Test des.: IEC 61000-4-11	70% dip during 25 cycles @ 50Hz, 30 cycles @ 60Hz 0% dip during ½ cycles

7 - Safety Agency Approvals

Specification item	Value	Condition
ENEC* / CE	EN 61347-1:2015, EN 61347-2-13:2014/A1:2017	LED Modules & EN55015 (EMC compliance)



* ENEC certification is in-progress



9 - Graphs

Operating Window

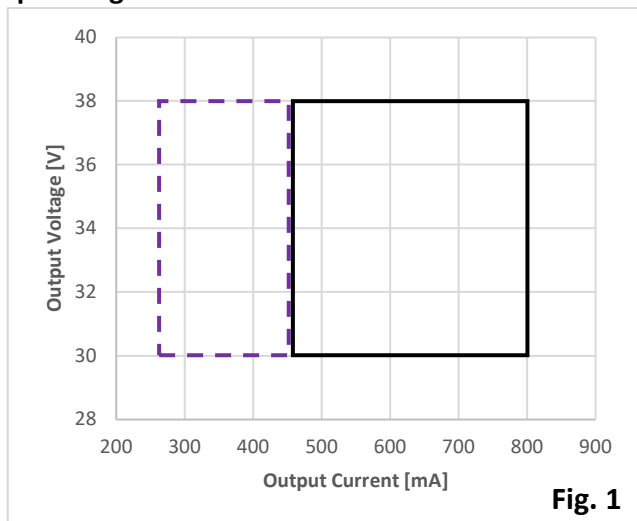

Fig. 1

Power Factor vs Output Power

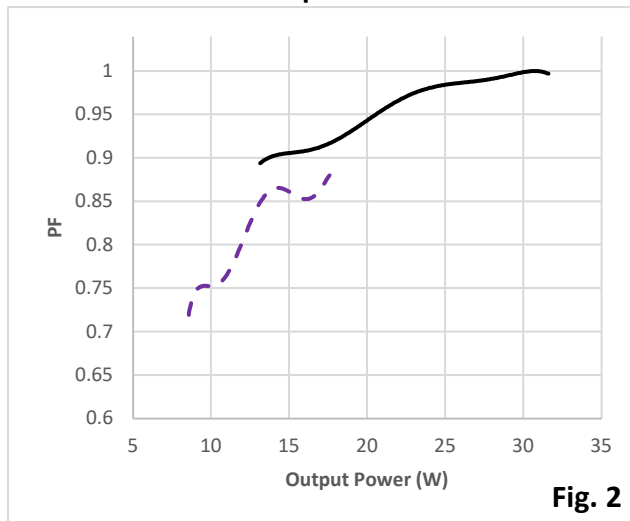

Fig. 2

Efficiency vs. Output Power

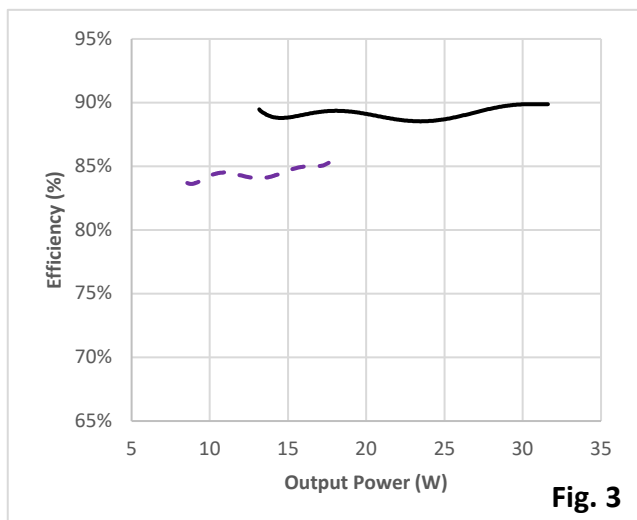

Fig. 3

I-THD vs. Output Power

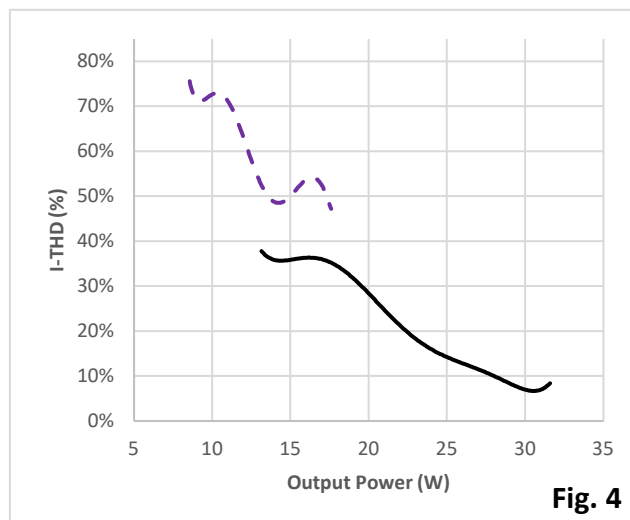

Fig. 4

Input Current vs. Output Power

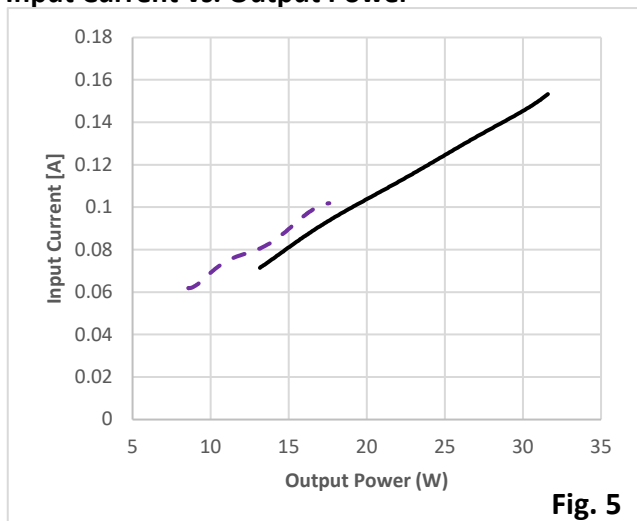
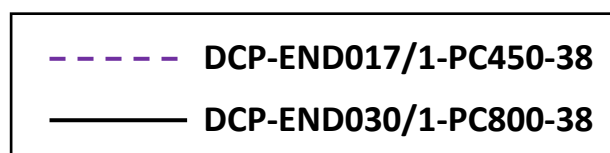
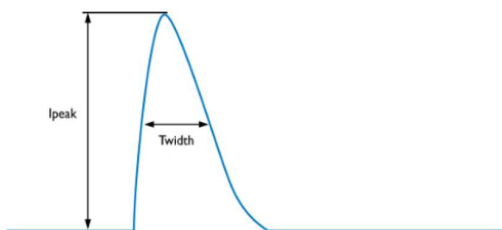

Fig. 5





10 - Inrush Current



P/N	I _{peak} (A)	T _{width} (Time @50% of I _{peak})
DCP-END017/1-PC450-38	2.28 A	146 μs
DCP-END030/1-PC800-38	2.52 A	134 μs

11 - Estimated Maximum Number of Drivers per Miniature Circuit Breaker (MCB)*

P/N	B10	B13	B16	B20	C10	C13	C16	C20
DCP-END017/1-PC450-38	60	78	96	120	70	91	112	140
DCP-END030/1-PC800-38	40	52	64	80	47	61	75	93

12 - Ordering Info

Specification item	Value	Condition
17W Round Driver	DCP-END017/1-PC450-38	
30W Round Driver	DCP-END030/1-PC800-38	

* Estimation based on typical MCB characteristics; recommend users to calculate the actual number with MCB parameters intended to be used

