

# Agilent HCPL-354 AC Input Phototransistor Optocoupler SMD Mini-Flat Type Data Sheet

## Description

The HCPL-354 contains a phototransistor, optically coupled to two light emitting diodes connected inverse parallel. It can operate directly by AC input current. It is packaged in a 4-pin mini-flat SMD package with a 2.0 mm profile. The small dimension of this product allows significant space saving. The package volume is 30% smaller than that of conventional DIP type. Input-output isolation voltage is 3750 V<sub>rms</sub>. Response time, t<sub>r</sub>, is typically 4 μs and minimum CTR is 20% at input current of ± 1 mA.

## Ordering Information

Specify Part Number followed by Option Number (if desired).

HCPL-354-XXXXE

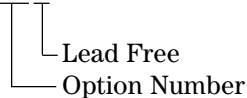

- 000 = No Options
- 060 = IEC/EN/DIN EN 60747-5-2 Option
- 00A = Rank Mark A

## Functional Diagram

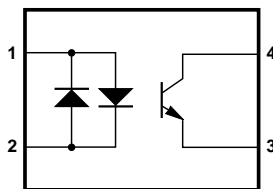

- 1. ANODE, CATHODE
- 2. CATHODE, ANODE
- 3. EMITTER
- 4. COLLECTOR

## Features

- AC input response
- Current transfer ratio (CTR: min. 20% at I<sub>F</sub> = ± 1 mA, V<sub>CE</sub> = 5 V)
- Isolation voltage between input and output (V<sub>iso</sub> = 3,750 V<sub>rms</sub>)
- Subminiature type (The volume is smaller than that of conventional DIP type by as far as 30%)
- Mini-flat package
- 2.0 mm profile
- UL approved
- CSA approved
- IEC/EN/DIN EN 60747-5-2 approved
- Options available:
  - IEC/EN/DIN EN 60747-5-2 approvals (060)

## Applications

- Detecting or monitoring AC signals
- Programmable controllers
- AC/DC-input modules
- AC line/digital logic isolation

**CAUTION:** It is advised that normal static precautions be taken in handling and assembly of this component to prevent damage and/or degradation which may be induced by ESD.



## Package Outline Drawing

### HCPL-354-000E

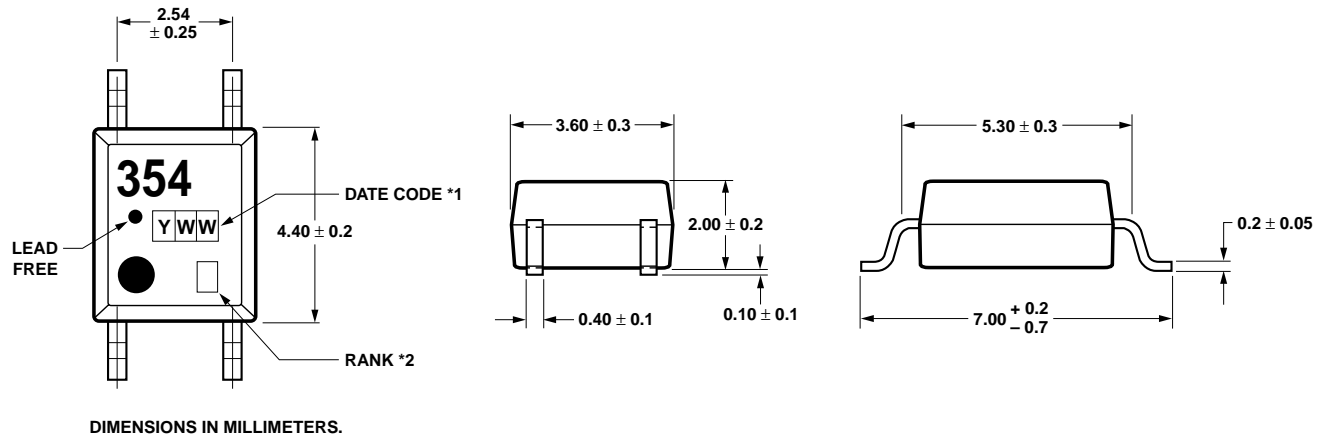

### HCPL-354-060E

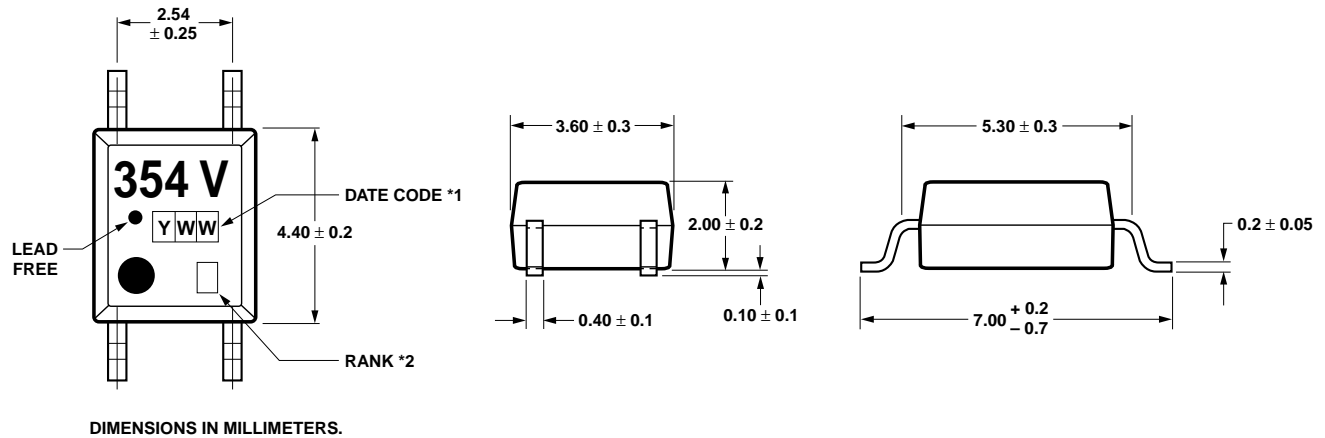

## Solder Reflow Temperature Profile

- 1) One-time soldering reflow is recommended within the condition of temperature and time profile shown at right.
- 2) When using another soldering method such as infrared ray lamp, the temperature may rise partially in the mold of the device. Keep the temperature on the package of the device within the condition of (1) above.

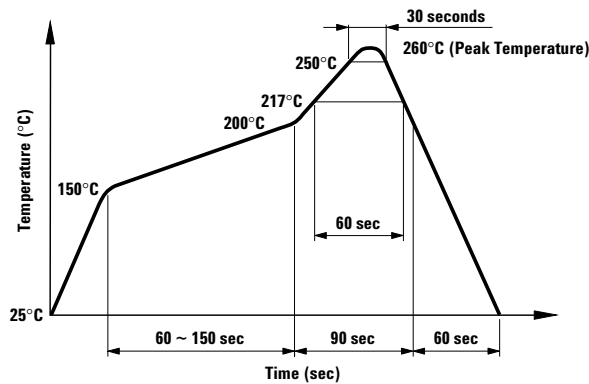

### Absolute Maximum Ratings

Parameters	Symbol	Min.	Max.	Units
Storage Temperature	$T_S$	-55	150	°C
Ambient Operating Temperature	$T_A$	-55	100	°C
Lead Solder Temperature for 10s (1.6 mm below seating plane)	$T_{sol}$		260	°C
Average Forward Current	$I_F$		±50	mA
Input Power Dissipation	$P_I$		70	mW
Collector Current	$I_C$		50	mA
Collector-Emitter Voltage	$V_{CEO}$		35	V
Emitter-Collector Voltage	$V_{ECO}$		6	V
Collector Power Dissipation	$P_C$		150	mW
Total Power Dissipation	$P_{tot}$		170	mW
Isolation Voltage (AC for 1 minute, R.H. = 40 ~ 60%) <sup>[1]</sup>	$V_{iso}$		3750	$V_{rms}$

### Electrical Specifications ( $T_A = 25^\circ\text{C}$ )

Parameter	Symbol	Min.	Typ.	Max.	Units	Test Conditions
Forward Voltage	$V_F$	–	1.2	1.4	V	$I_F = \pm 20\text{ mA}$
Terminal Capacitance	$C_t$	–	30	250	pF	$V = 0, f = 1\text{ kHz}$
Collector Dark Current	$I_{CEO}$	–	–	100	nA	$V_{CE} = 20\text{ V}, I_F = 0$
Collector-Emitter Breakdown Voltage	$BV_{CEO}$	35	–	–	V	$I_C = 0.1\text{ mA}, I_F = 0$
Emitter-Collector Breakdown Voltage	$BV_{ECO}$	6	–	–	V	$I_E = 10\ \mu\text{A}, I_F = 0$
Collector Current	$I_C$	0.2	–	4	mA	$I_F = \pm 1\text{ mA}$ ,
Current Transfer Ratio <sup>[2]</sup>	CTR	20	–	400	%	$V_{CE} = 5\text{ V}$
Collector-Emitter Saturation Voltage	$V_{CE(sat)}$	–	0.1	0.2	V	$I_F = \pm 20\text{ mA}, I_C = 1\text{ mA}$
Isolation Resistance	$R_{iso}$	$5 \times 10^{10}$	$1 \times 10^{11}$	–	$\Omega$	DC 500 V 40 ~ 60% R.H.
Floating Capacitance	$C_f$	–	0.6	1	pF	$V = 0, f = 1\text{ MHz}$
Response Time (Rise)	$t_r$	–	4	18	$\mu\text{s}$	$V_{CE} = 2\text{ V}, I_C = 2\text{ mA}$ ,
Response Time (Fall)	$t_f$	–	3	18	$\mu\text{s}$	$R_L = 100\ \Omega$

Rank Mark	CTR (%)	Conditions
A	50 ~ 150	$I_F = \pm 1\text{ mA}$ ,
No Mark	20 ~ 400	$V_{CE} = 5\text{ V}$ , $T_A = 25^\circ\text{C}$

#### Notes:

- Isolation voltage shall be measured using the following method:
  - Short between anode and cathode on the primary side and between collector and emitter on the secondary side.
  - The isolation voltage tester with zero-cross circuit shall be used.
  - The waveform of applied voltage shall be a sine wave.

$$2. \text{CTR} = \frac{I_C}{I_F} \times 100\%$$

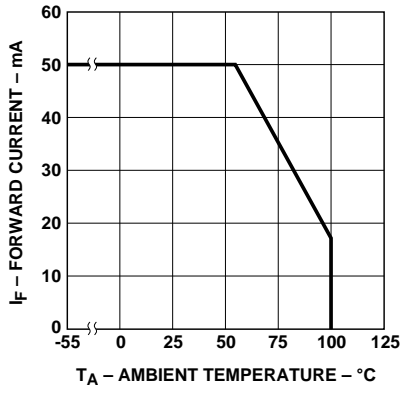

Figure 1. Forward current vs. ambient temperature.

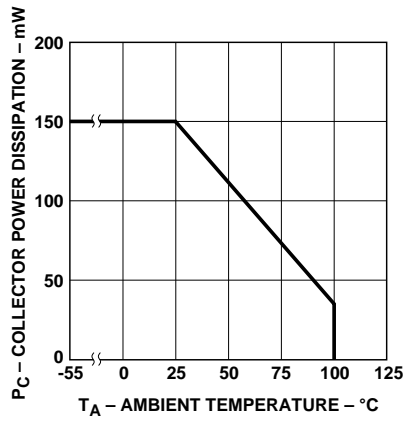

Figure 2. Collector power dissipation vs. ambient temperature.

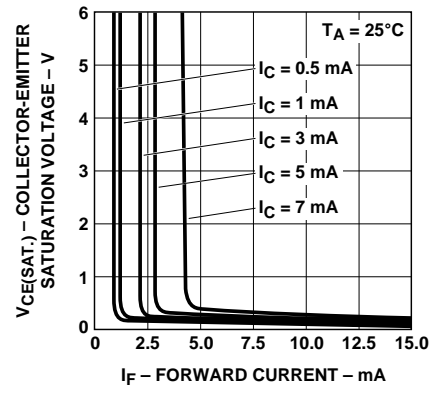

Figure 3. Collector-emitter saturation voltage vs. forward current.

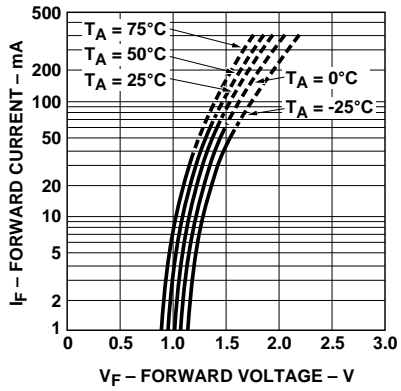

Figure 4. Forward current vs. forward voltage.

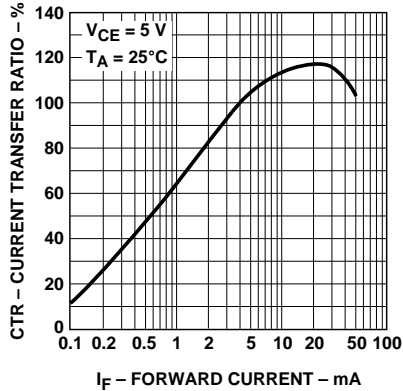

Figure 5. Current transfer ratio vs. forward current.

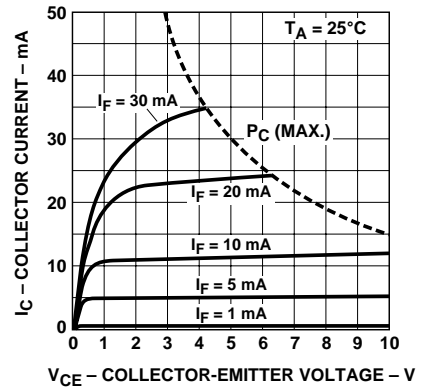

Figure 6. Collector current vs. collector-emitter voltage.

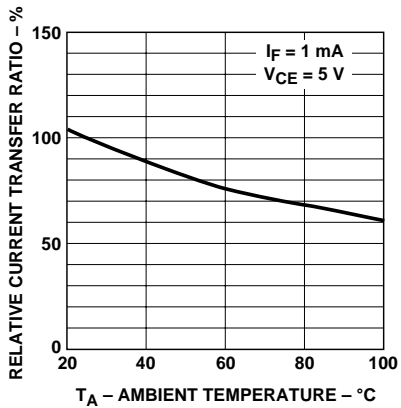

Figure 7. Relative current transfer ratio vs. ambient temperature.

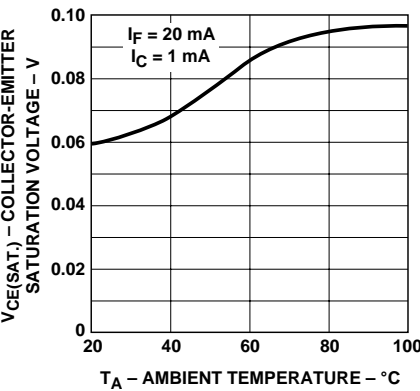

Figure 8. Collector-emitter saturation voltage vs. ambient temperature.

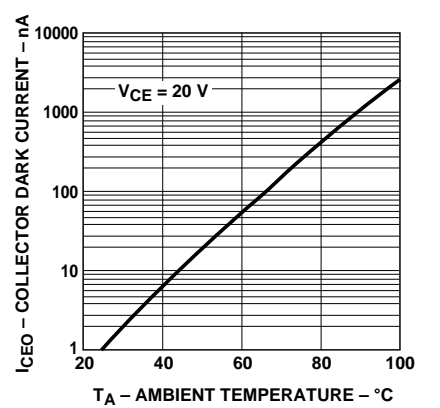

Figure 9. Collector dark current vs. ambient temperature.

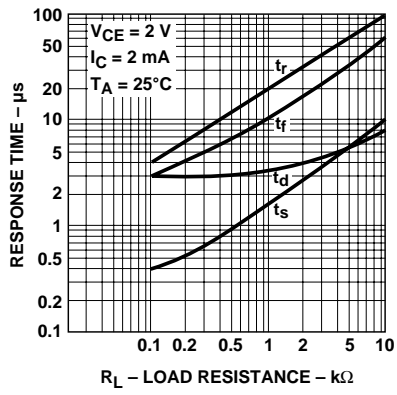

Figure 10. Response time vs. load resistance.

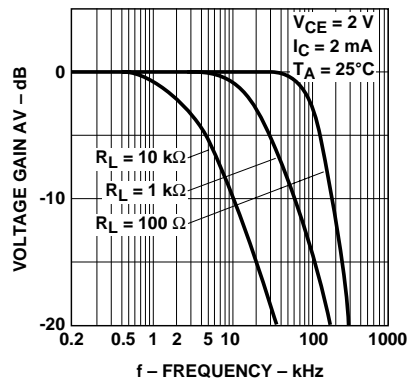

Figure 11. Frequency response.

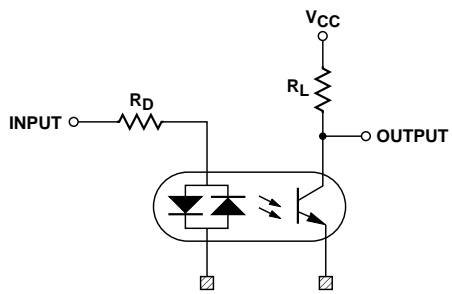

Figure 12. Test circuit for response time.

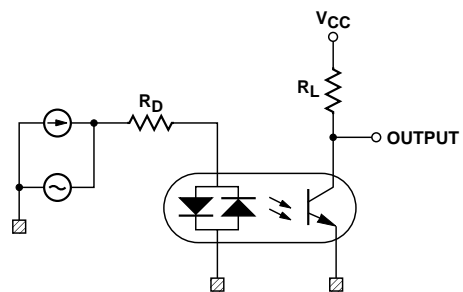
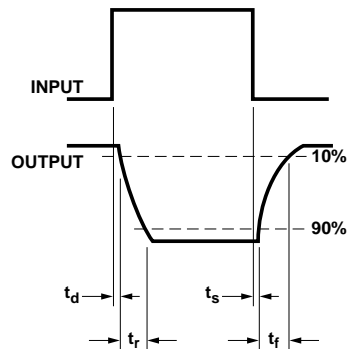

Figure 13. Test circuit for frequency response.

**[www.agilent.com/semiconductors](http://www.agilent.com/semiconductors)**

For product information and a complete list of distributors, please go to our web site.

For technical assistance call:

Americas/Canada: +1 (800) 235-0312 or  
(916) 788-6763

Europe: +49 (0) 6441 92460

China: 10800 650 0017

Hong Kong: (+65) 6756 2394

India, Australia, New Zealand: (+65) 6755 1939

Japan: (+81 3) 3335-8152 (Domestic/International), or 0120-61-1280 (Domestic Only)

Korea: (+65) 6755 1989

Singapore, Malaysia, Vietnam, Thailand,  
Philippines, Indonesia: (+65) 6755 2044

Taiwan: (+65) 6755 1843

Data subject to change.

Copyright © 2004 Agilent Technologies, Inc.

Obsoletes 5989-0313EN

November 3, 2004

5989-1739EN



**Agilent Technologies**

This datasheet has been download from:

[www.datasheetcatalog.com](http://www.datasheetcatalog.com)

Datasheets for electronics components.