

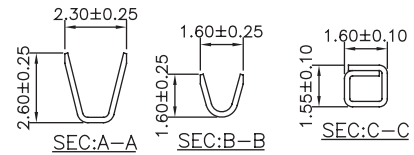

CONNECTORS MANUFACTURE

2.54mm TERMINAL / HOUSING

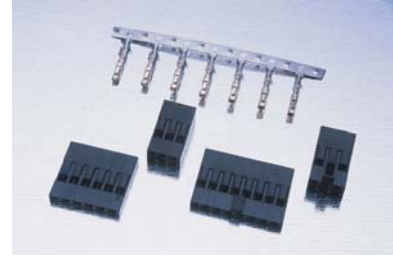
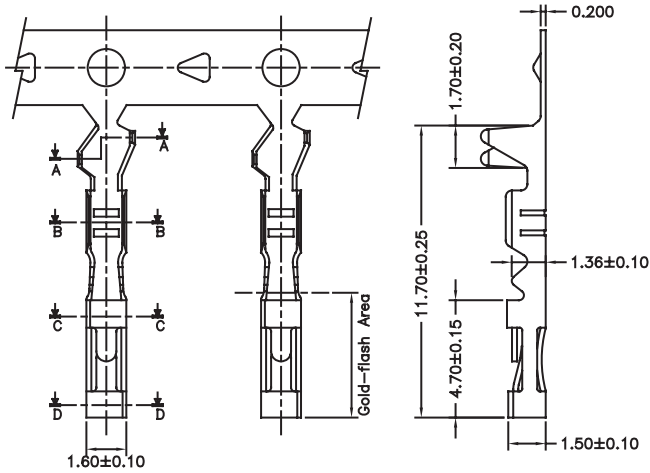

Part No	Wire Range	Insulation O.D.	Material	Finish	Qty/reel
2541-TGP-L	AWG#22-#26	1.63mm(max)	Phosphor Bronze	Gold-flash	
2541-TGB-L	AWG#22-#26	1.63mm(max)	Brass	Gold-flash	10,000pcs
2541-TTP-L	AWG#22-#26	1.63mm(max)	Phosphor Bronze	Tin-plated	

Part No.:2541-T-L

SPECIFICATIONS

Current Rating: 3A AC,DC
 Voltage Rating: 250V AC,DC
 Temperature Range: -25°C ~ +85°C
 Contact Resistance: 20mΩ Max
 Insulation Resistance: 1000MΩ Min
 Withstanding Voltage: 1500V AC/minute
 Material: Nylon 66,UL94V-0
 Color: Black

Part No.:2541H-□XXB□-L

1:WITH BUMP
 2:W/O BUMP

1:Single rows
 2:Dual rows

CONTACT	Dimensions	
	A	B
01	---	2.54
02	2.54	5.08
03	5.08	7.62
04	7.62	10.16
05	10.16	12.70
06	12.70	15.24
07	15.24	17.78
08	17.78	20.32
09	20.32	22.86
10	22.86	25.40
11	25.40	27.94
12	27.94	30.48
13	30.48	33.02
14	33.02	35.56
15	35.56	38.10
16	38.10	40.64
17	40.64	43.18
18	43.18	45.72
19	45.72	48.26
20	48.26	50.80
21	50.80	53.34
22	53.34	55.88
23	55.88	58.42
24	58.42	60.96
25	60.96	63.50
26	63.50	66.04
27	66.04	68.58
28	68.58	71.12
29	71.12	73.66
30	73.66	76.20
31	76.20	78.74
32	78.74	81.28
33	81.28	83.82
34	83.82	86.36
35	86.36	88.90
36	88.90	91.44
37	91.44	93.98
38	93.98	96.52
39	96.52	99.06
40	99.06	101.60

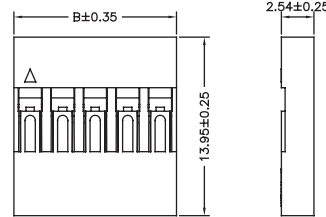
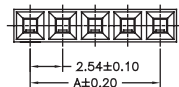

W/O Bump

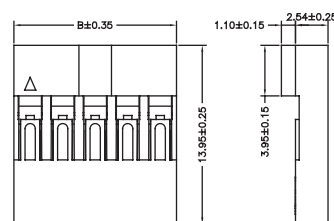
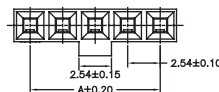

With Bump

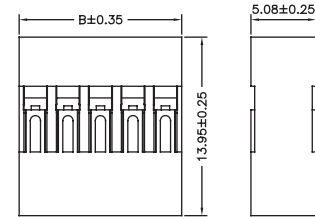
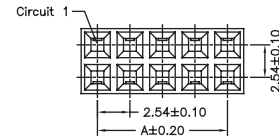

W/O Bump

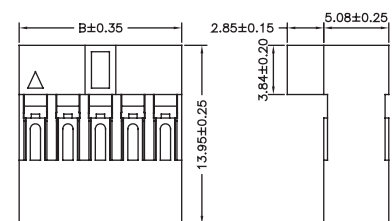
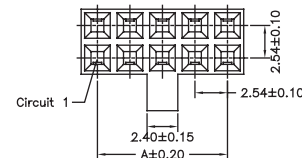

With Bump

Housing Wafer Terminal



AMTEK CONNECTOR MANUFACTURE