



Glass Passivated Single-Phase Bridge Rectifier

Major Ratings and Characteristics

$I_{F(AV)}$	6 A
V_{RRM}	50 V to 1000 V
I_{FSM}	175 A
I_R	5 μ A
V_F	1.0 V
T_j max.	150 °C

Case Style GBPC6

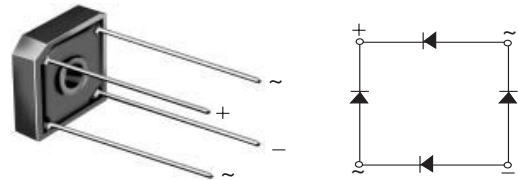

Features

- UL Recognition file number E54214
- Ideal for printed circuit boards
- Typical I_R less than 0.5 μ A
- High surge current capability
- High case dielectric strength 1500 V_{RMS}
- Solder Dip 260 °C, 40 seconds



Mechanical Data

Case: GBPC6

Epoxy meets UL-94V-0 Flammability rating

Terminals: Silver plated (E4 Suffix) leads, solderable per J-STD-002B and JESD22-B102D

Polarity: As marked, Positive lead by beveled corner

Mounting Torque: 10 cm-kg (8.8 inches-lbs) max.

Recommended Torque: 5.7 cm-kg (5 inches-lbs)

Typical Applications

General purpose use in ac-to-dc bridge full wave rectification for Power Supply, Home Appliances, Office Equipment, Industrial Automation applications

Maximum Ratings

Ratings at 25 °C ambient temperature unless otherwise specified.

Parameter	Symbols	GBPC 6005	GBPC 601	GBPC 602	GBPC 604	GBPC 606	GBPC 608	GBPC 610	Unit
Maximum repetitive peak reverse voltage	V_{RRM}	50	100	200	400	600	800	1000	V
Maximum RMS bridge input voltage	V_{RMS}	35	70	140	280	420	560	700	V
Maximum DC blocking voltage	V_{DC}	50	100	200	400	600	800	1000	V
Maximum average forward rectified output current at $T_C = 50$ °C ⁽¹⁾⁽²⁾ $T_A = 40$ °C ⁽³⁾	$I_{F(AV)}$	6.0 3.0							A
Peak forward surge current single sine-wave superimposed on rated load	I_{FSM}	175							A
Rating for fusing ($t < 8.3$ ms)	I^2t	127							A ² sec
Operating junction and storage temperature range	T_J, T_{STG}	- 55 to + 150							°C

Electrical Characteristics

Ratings at 25 °C ambient temperature unless otherwise specified.

Parameter	Test condition	Symbols	GBPC 6005	GBPC 601	GBPC 602	GBPC 604	GBPC 606	GBPC 608	GBPC 610	Unit
Maximum instantaneous forward voltage drop per leg	at 3.0 A	V_F	1.0							V
Maximum DC reverse current at rated DC blocking voltage per leg	$T_A = 25\text{ °C}$ $T_A = 125\text{ °C}$	I_R	5.0 500							μA
Typical junction capacitance per leg	at 4.0 V, 1 MHz	C_J	186				90			pF

Thermal Characteristics

Ratings at 25 °C ambient temperature unless otherwise specified.

Parameter	Symbols	GBPC 6005	GBPC 601	GBPC 602	GBPC 604	GBPC 606	GBPC 608	GBPC 610	Unit	
Typical thermal resistance per leg ⁽¹⁾	$R_{\theta JA}$ $R_{\theta JC}$	22 7.3								$^{\circ}\text{C/W}$

Notes:

- (1) Bolt down on heat-sink with silicone thermal compound between bridge and mounting surface for maximum heat transfer with #6 screw
- (2) Unit mounted on 5.5 x 6.0 x 0.11" thick (14 x 15 x 0.3 cm) Al. Plate
- (3) Unit mounted on P.C.B. at 0.375" (9.5 mm) lead length with 0.5 x 0.5" (12 x 12 mm) copper pads

Ratings and Characteristics Curves

($T_A = 25\text{ °C}$ unless otherwise noted)

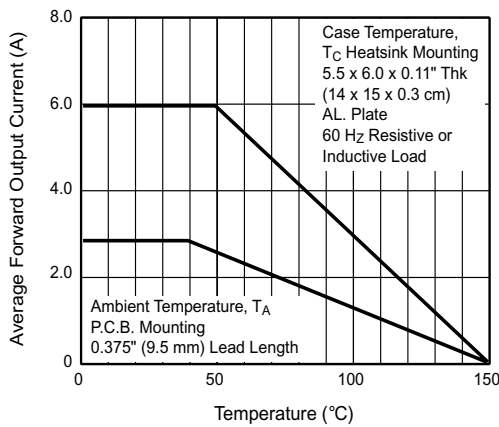

Figure 1. Derating Curve Output Rectified Current

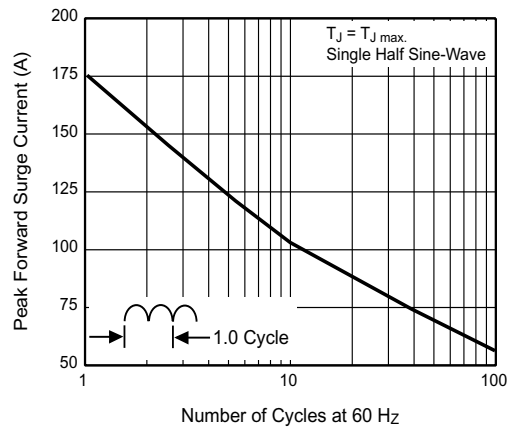

Figure 2. Maximum Non-Repetitive Peak Forward Surge Current Per Leg

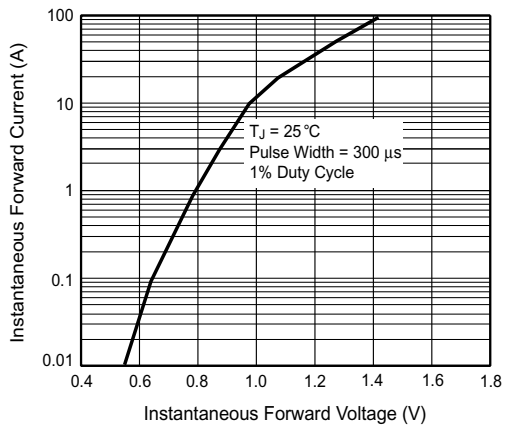

Figure 3. Typical Forward Characteristics Per Leg

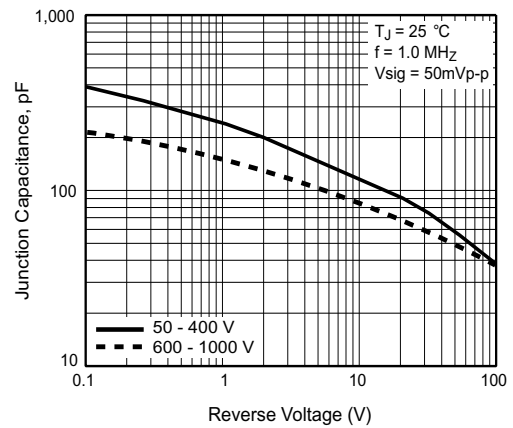

Figure 5. Typical Junction Capacitance Per Leg

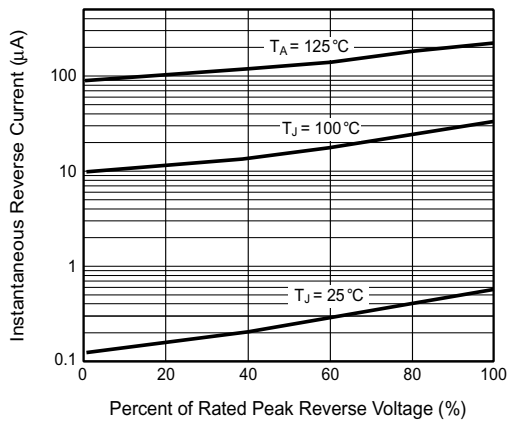

Figure 4. Typical Reverse Leakage Characteristics Per Leg

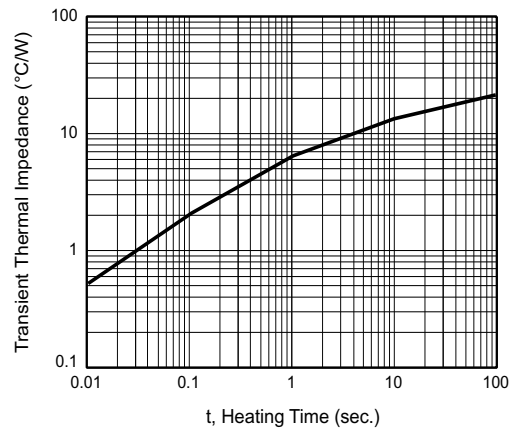
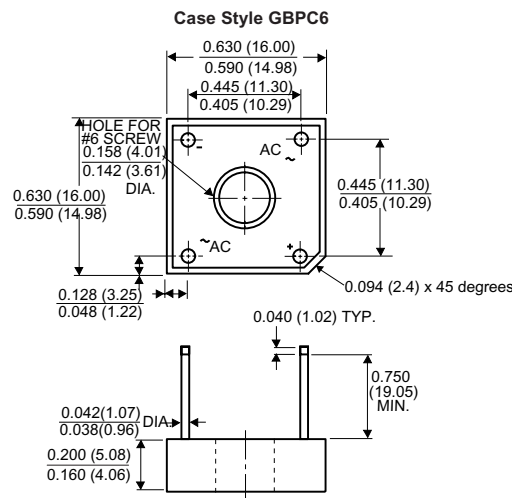

Figure 6. Typical Transient Thermal Impedance Per Leg

Package outline dimensions in inches (millimeters)



Polarity shown on side of case: Positive lead by beveled corner