

# Carbon Film Fixed Resistors:

## Feature

- High quality performance
- Great economy
- Flame retardant type available
- Automatically insertable

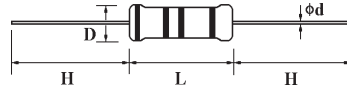

## Specifications

Part No.	Type	Power Rating At 70°C	Dimension (mm)				Max. Working Voltage	Max. Overload Voltage	Dielectric Withstanding Voltage	Resistance Range
			D Max.	L Max.	d +0.02 -0.05	H ± 3				
<b>Normal Size</b>										
CFR0W8	CFR-12	1/8W	1.85	3.5	0.5	28	200V	400V	400V	1Ω ~ 1MΩ
CFR0W4	CFR-25	1/4W	2.5	6.8	0.6	28	250V	500V	500V	1Ω ~ 10MΩ
CFR0W2	CFR-50	1/2W	3.5	10	0.6	28	350V	700V	700V	1Ω ~ 10MΩ
CFR01W	CFR-100	1W	5.5	16	0.8	28	500V	1000V	1000V	1Ω ~ 10MΩ
CFR02W	CFR-200	2W	6.5	17.5	0.8	28	500V	1000V	1000V	1Ω ~ 10MΩ
<b>Small Size &amp; Extra Small Size</b>										
CFR0S4	CFR-25-S	1/4W	1.85	3.5	0.5	28	200V	400V	400V	1Ω ~ 1MΩ
CFR0U2	CFR-50-SS	1/2W	2.5	6.8	0.6	28	250V	500V	250V	1Ω ~ 10MΩ
CFR0S2	CFR-50-S	1/2W	3	9	0.6	28	350V	700V	700V	1Ω ~ 10MΩ
CFR01S	CFR-100-S	1W	5	12	0.7	28	500V	1000V	1000V	1Ω ~ 10MΩ
CFR02S	CFR-200-S	2W	5.5	16	0.8	28	500V	1000V	1000V	1Ω ~ 10MΩ
CFR03S	CFR-300-S	3W	6.5	17.5	0.8	28	500V	1000V	1000V	1Ω ~ 10MΩ

- Standard E-24 series values in ± 5% tolerance
- Standard Beige base color; Special Lavender base color for CFR01S, CFR02S & CFR03S
- Standard Grayish-green base color (Non-Flammable coating) for CFR0U2 (CFR-50-SS)
- For any special inquiry which including too low or high ohmic values is available on a case to case basis

## Derating Curve

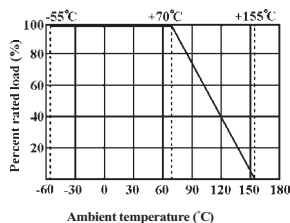

## Current Noise Level

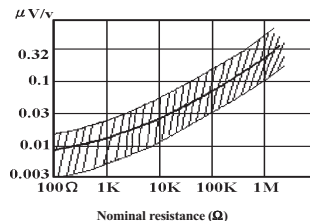

## Temperature Coefficient

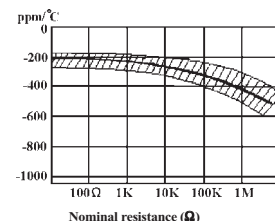

## Carbon Film Fixed Resistors:

### Performance Specifications

<b>Temperature coefficient</b>	±300PPM/°C for ≤10Ω; ±450PPM/°C for 11Ω ~ 99KΩ; 0 ~ -700PPM/°C for 100KΩ ~ 1MΩ; 0 ~ -1500PPM/°C for 1.1MΩ ~ 10MΩ.
<b>Short-time overload</b>	ΔR/R ≤ ±(1%+0.05Ω), with no evidence of mechanical damage.
<b>Insulation resistance</b>	Min. 10,000Mega Ohm.
<b>Dielectric withstanding voltage</b>	No evidence of flashover, mechanical damage, arcing or insulation breakdown.
<b>Terminal strength</b>	No evidence of mechanical damage.
<b>Resistance to Soldering heat</b>	ΔR/R ≤ ±(1%+0.05Ω), with no evidence of mechanical damage.
<b>Solderability</b>	Min. 95% coverage.
<b>Resistance to solvent</b>	No deterioration of protective coating and markings.
<b>Temperature cycling</b>	ΔR/R ≤ ±(1%+0.05Ω), with no evidence of mechanical damage.
<b>Load life in humidity</b>	Normal type: ΔR/R ± 3% for <100KΩ, ±5% for ≥100KΩ; Flame retardant type: ΔR/R ± 5% for <100KΩ, ±10% for ≥100KΩ
<b>Load life</b>	Normal type: ΔR/R ±2% for <56KΩ, ±3% for ≥56KΩ; Flame retardant type: ΔR/R ±5% for <100KΩ, ±10% for ≥100KΩ

### Ordering Procedure (Example: CFR 1/4W Small Size Non – Flame 5% 10KΩ T/B-5000)

#### Special Features:

0 = Standard product, F = Flame Retardant, I = Non - Inductive

**Wattage:** Normal size: W8 = 1/8W, W4 = 1/4W, W2 = 1/2W, 1W = 1W, 2W = 2W  
Small size: S4 = 1/4W-S, S2 = 1/2W-S, 1S = 1W-S, 2S = 2W-S, 3S = 3W-S  
Extra small size: U2 = 1/2W-SS

**Tolerance:** G = ± 2% , J = ± 5% , K = ± 10%

**Packing Type:** A = Tape/Box, T = Tape/Reel, B = Bulk/Box,  
P = Tape/Box of PT-26 product

#### Resistance Value:

E-24 series:  
The 1<sup>st</sup> digit will be "0";  
the 2<sup>nd</sup> & 3<sup>rd</sup> digits are  
for the significant figures  
of the resistance and the  
4<sup>th</sup> digit indicate the  
numbers of zeros  
following

#### Packing Quantity:

1 = 1,000pcs, 2 = 2,000pcs, 3 = 3,000pcs, 4 = 4,000pcs  
5 = 5,000pcs, A = 500pcs, B = 2,500pcs,  
0 = for Bulk/Box packing

**Additional Information:** 0 = NIL

**Product Type:**  
CFR = Carbon Film  
Fixed Resistors

**C F R F S 4 J 0 1 0 3 A 5 0**

# Precision Metal Film Fixed Resistors:

## Feature:

- EIA standard color coding
- Flame retardant type available
- Low noise & voltage coefficient
- Low temperature coefficient range
- Multiple epoxy coating on vacuum-deposited metal film provides superior moisture protection
- Nichrome resistor element provides stable performance in various environments

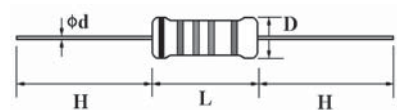
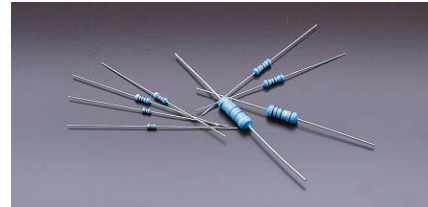

Part No.	Type	Power Rating At 70°C	Dimension (mm)			
			D Max.	L Max.	d <sup>+0.02</sup> <sub>-0.05</sub>	H ±3
<b>Normal Size</b>						
MFR0W8	MF-12	1/8W	1.85	3.5	0.5	28
MFR0W4	MF-25	1/4W	2.5	6.8	0.6	28
MFR0W2	MF-50	1/2W	3.5	10	0.6	28
MFR01W	MF-100	1W	5	12	0.7	28
MFR02W	MF-200	2W	5.5	16	0.8	28
MFR03W	MF-300	3W	6.5	17.5	0.8	28

## Derating Curve:

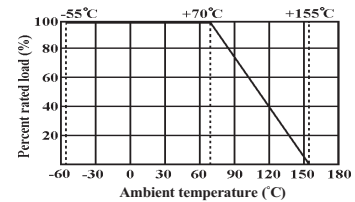

<b>Small Size &amp; Extra Small Size</b>						
MFR0S4	MF-25-S	1/4W	1.85	3.5	0.5	28
MFR004	MF-40-SS	0.4W	1.9	3.7	0.5	28
MFR0U2	MF-50-SS	1/2W	2.5	6.8	0.6	28
MFR0S2	MF-50-S	1/2W	3	9	0.6	28
MFR006	MF-60-S	0.6W	2.5	6.8	0.6	28

Standard Non-Flammable coating for Small size types (except MF-50-S).

## Load Life:

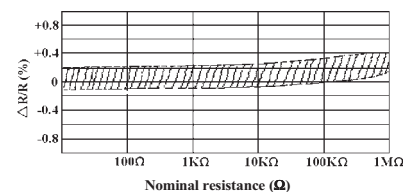

Part No.	Type	Dielectric With-standing V.	Max. Working V.	Max. Overload V.	Standard Order			Special Order		
					Tol.	T.C.R.	Value Range	Tol.	T.C.R.	Value Range
MFR0W8	MF-12	400V	200V	400V	±1%	± 50	10Ω-1MΩ	± 0.25%	± 15	51.1Ω ~ 200KΩ
MFR0S4	MF-25-S	200V	200V	400V	±2%	± 100	10Ω-1MΩ	± 0.5%	± 25	51.1Ω ~ 511KΩ
MFR004	MF-40-SS				±5%	± 200	1Ω-1MΩ	± 0.5%	± 50	51.1Ω ~ 511KΩ
MFR0W4	MF-25	500V	250V	500V	±1%	± 50	10Ω-1MΩ	± 0.1%	± 15	100Ω ~ 100KΩ
MFR0U2	MF-50-SS	250V			±2%	± 100	10Ω-1MΩ	± 0.25%	± 25	51.1Ω ~ 330KΩ
MFR006	MF-60-S				±5%	± 200	1Ω-1MΩ	± 0.5%	± 50	10Ω ~ 1MΩ
MFR0S2	MF-50-S	700V	350V	700V	±1%	± 50	10Ω-1MΩ	± 0.1%	± 15	100Ω ~ 330KΩ
MFR0W2	MF-50				±2%	± 100	10Ω-1MΩ	± 0.25%	± 25	51.1Ω ~ 511KΩ
					±5%	± 200	1Ω-1MΩ	± 0.5%	± 50	10Ω ~ 1MΩ
MFR01W	MF-100	1000V	500V	1000V	±1%	± 50	51.1Ω-1MΩ	± 0.1%	± 15	100Ω~ 330KΩ
MFR02W	MF-200				±2%	± 100	51.1Ω-1MΩ	± 0.25%	± 25	51.1Ω ~ 511KΩ
MFR03W	MF-300				±5%	± 200	10Ω-1MΩ	± 0.5%	± 50	51.1Ω ~ 1MΩ

## Precision Metal Film Fixed Resistors:

### Performance Specifications

<b>Temperature coefficient</b>	Within the maximum temperature coefficient specified in page 12.
<b>Short-time overload</b>	$\Delta R/R \leq \pm(0.5\% + 0.05\Omega)$ , with no evidence of mechanical damage.
<b>Dielectric withstanding voltage</b>	No evidence of flashover, mechanical damage, arcing or insulation breakdown.
<b>Pulse overload</b>	$\Delta R/R \leq \pm(1\% + 0.05\Omega)$ , with no evidence of mechanical damage.
<b>Terminal strength</b>	No evidence of mechanical damage.
<b>Resistance to Soldering heat</b>	$\Delta R/R \leq \pm(1\% + 0.05\Omega)$ , with no evidence of mechanical damage.
<b>Solderability</b>	Min. 95% coverage.
<b>Resistance to solvent</b>	No deterioration of protective coating and markings.
<b>Temperature cycling</b>	$\Delta R/R \leq \pm(1\% + 0.05\Omega)$ , with no evidence of mechanical damage.
<b>Load life in humidity</b>	Normal type: $\Delta R/R \pm 1.5\%$ ; Flame retardant type: $\Delta R/R \pm 5\%$ .
<b>Load life</b>	Normal type: $\Delta R/R \pm 1.5\%$ ; Flame retardant type: $\Delta R/R \pm 5\%$ .

### Current Noise Level:

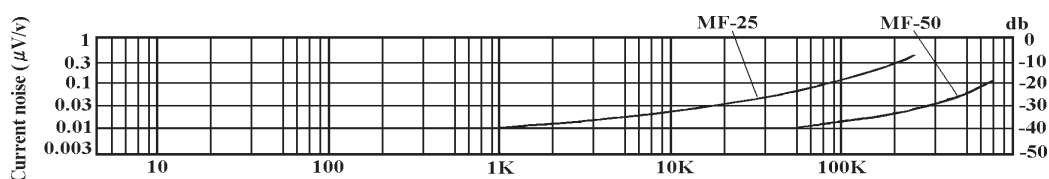

### Ordering Procedure (Example: MFR 1/8W 1% 50PPM 47.5KΩ T/R-5000)

**Special Features:** 0 = Standard product, F = Flame Retardant, I = Non - Inductive

**Tolerance:**

B=±0.1% 15PPM, C=±0.25% 25PPM, D=±0.5% 50PPM, F=±1% 50PPM, G=±2% 100PPM, J=±5% 200PPM  
 For special tolerance – PPM requirement. Please indicate it in the purchase order (P.O.)  
 Example : ±1% 15PPM

**Wattage:**

Normal size:  
 W8 = 1/8W  
 W4 = 1/4W  
 W2 = 1/2W  
 1W = 1W  
 2W = 2W  
 Small size:  
 S4 = 1/4W-S  
 S2 = 1/2W-S  
 06 = 0.6W-S  
 Extra small size:  
 U2 = 1/2W-SS  
 04 = 0.4W-SS

**Resistance Value:**

E-24 series (2% & 5% Tol.):  
 The 1<sup>st</sup> digit will be "0"; the 2<sup>nd</sup> & 3<sup>rd</sup> digits are for the significant figures of the resistance and the 4<sup>th</sup> digit indicate the numbers of zeros following  
 E-96 series (1% Tol.) :  
 The 1<sup>st</sup> digit to 3<sup>rd</sup> digit are for the significant figures of the resistance and the 4<sup>th</sup> digit denotes number of zero following

**Packing Type:**

A=Tape/Box, T=Tape/Reel, B=Bulk/Box, P=Tape/Box of PT-26 product

**Packing Quantity:**

1=1,000pcs, 2=2,000pcs, 3=3,000pcs, 4=4,000pcs  
 5=5,000pcs, A=500pcs, B=2,500pcs,  
 0=for Bulk/Box packing

**Additional Information:** 0 = NIL

**M F R 0 W 8 F 4 7 5 2 T 5 0**

## Panasert Type:

### Feature:

- This specification is applicable to CFR 1/4W of Carbon Film Fixed Resistors & MFR 1/4W of Metal Film Fixed Resistors

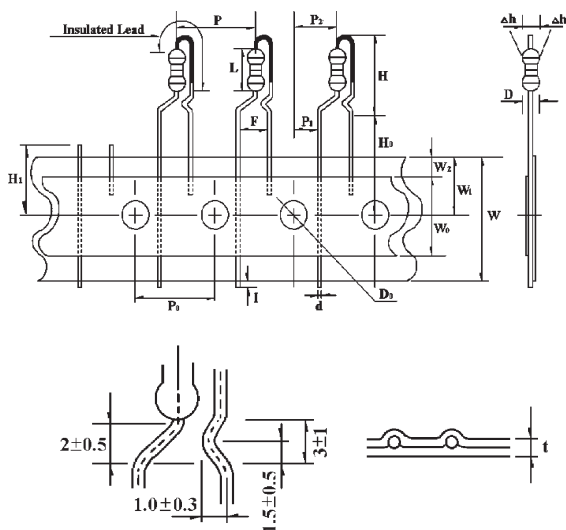

Body diameter (D)	2.5 Max.
Body Length (L)	6.8 Max.
Body height (H)	12 Max.
Lead-wire diameter (d)	0.6 <sup>+0.02</sup> <sub>-0.05</sub>
Pitch of component (P)	12.7 ± 1
Feed hole pitch (P <sub>0</sub> )	12.7 ± 0.3
Hole center to lead (P <sub>1</sub> )	3.85 ± 0.7
Hole center to body (P <sub>2</sub> )	6.35 ± 1.3
Lead to lead distance (F)	5 ± 1
Component alignment (Δh)	0 ± 1
Tape width (W)	18 ± 1
Hold down tape width (W <sub>0</sub> )	12.5 Min.
Hole position (W <sub>1</sub> )	9 ± 0.5
Hold down tape position (W <sub>2</sub> )	3.0 Max.
Lead wire clinch height (H <sub>0</sub> )	16.5 Max.
Lead wire protrusion (l)	1.0 Max.
Feed hole diameter (D <sub>0</sub> )	4 ± 0.3
Total tape thickness (t)	0.5 ± 0.2
Length of snapped lead (H <sub>1</sub> )	11 Max.
Length of lead cut (H <sub>1</sub> -W <sub>1</sub> )	2 ± 0.5

*P<sub>0</sub> cumulative pitch error 1 mm / 20 pitch.*

### Ordering Procedure (Example: CFR 1/4W 5% 100K Ω T/B-2000 PANASERT Type)

**Special Features:** 0 = Standard product, F = Flame retardant, I = Non-inductive

**Tolerance (T.C.R.):** B = ± 0.1% (15PPM), C = ± 0.25% (25PPM), D = ± 0.5% (50PPM)  
F = ± 1% (50PPM), G = ± 2% (100PPM), J = ± 5% (200PPM)

**Resistance Value:**

E-24 series: The 1<sup>st</sup> digit will be "0"; the 2<sup>nd</sup> & 3<sup>rd</sup> digits are for the significant figures of the resistance and the 4<sup>th</sup> digit denotes number of zeros following.

E-96 series: The 1<sup>st</sup> to 3<sup>rd</sup> digits are for the significant figures of the resistance and the 4<sup>th</sup> digit denotes number of zeros following

**Packing Type:** A = Tape / Box, T = Tape / Reel

**Packing Quantity:**

2 = 2000(T/B only), 5 = 5000(T/R only)  
T/R is 2500pcs per reel & 2 reel per box

**Product Type:**

CFR = Carbon Film Fixed Resistors,  
MFR = Metal Film Fixed Resistors

**Wattage:**

W4 = 1/4W

**Additional Information:** P = PANASERT Type

**C F R 0 W 4 J 0 1 0 4 A 2 P**

# Avisert Type:

## Avisert type (1)

Applicable to CFR 1/4W of Carbon Film fixed Resistors & MFR 1/4 W of Metal Film Fixed Resistors

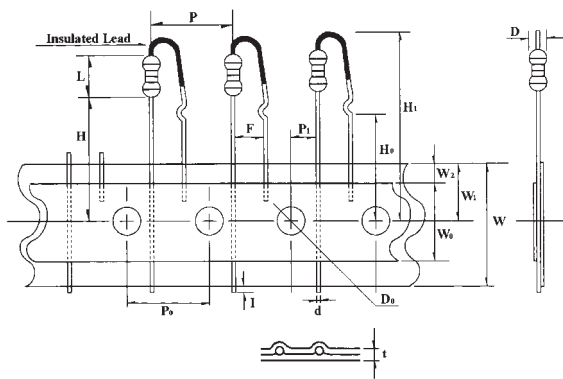

Body diameter (D)	2.5 Max.
Body Length (L)	6.8 Max.
Lead-wire diameter (d)	0.6 $\begin{smallmatrix} +0.02 \\ -0.05 \end{smallmatrix}$
Pitch of component (P)	12.7 $\pm$ 1
Feed hole pitch ( $P_0$ )	12.7 $\pm$ 0.3
Hole center to lead ( $P_1$ )	3.85 $\pm$ 0.7
Lead to lead distance (F)	5 $\pm$ 1
Tape width (W)	18 $\pm$ 1
Hold down tape width ( $W_0$ )	12.5 Min.
Hole position ( $W_1$ )	9.5 $\pm$ 0.5
Hold down tape position ( $W_2$ )	3.0 Max.
Lead wire clinch height ( $H_2$ )	16 $\pm$ 0.5
Component height ( $H_1$ )	32.25 Max.
Lead wire protrusion (l)	1.0 Max.
Feed hole diameter ( $D_0$ )	4 $\pm$ 0.3
Total tape thickness (t)	0.5 $\pm$ 0.2
Height of component from tape center (H)	16 $\pm$ 0.5

## Avisert type (2)

• Applicable to CFR 1/8W of Carbon Film Fixed Resistors & MFR 1/8W of Metal Film Fixed Resistors

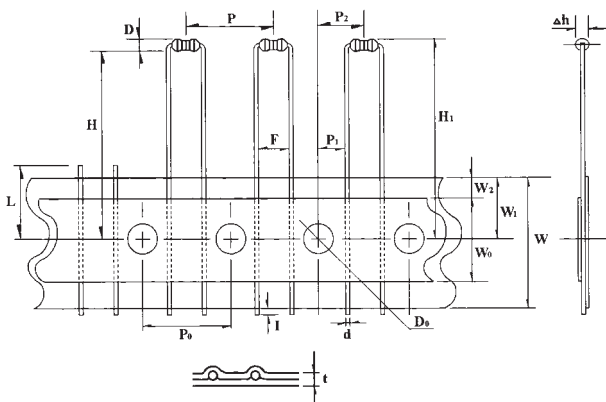

Body thickness (D)	2.0 Max
Lead-wire diameter (d)	0.5 $\begin{smallmatrix} +0.02 \\ -0.05 \end{smallmatrix}$
Pitch of component (P)	12.7 $\pm$ 1
Feed hole pitch ( $P_0$ )	12.7 $\pm$ 0.3
Hole center to lead ( $P_1$ )	3.84 $\pm$ 0.7
Lead to lead distance (F)	5 $\pm$ 1
Component alignment ( $\Delta h$ )	0 $\pm$ 1
Tape width (W)	18 $\pm$ 1
Hold down tape width ( $W_0$ )	12.5 Min
Hole position ( $W_1$ )	9 $\pm$ 0.5
Hold down tape position ( $W_2$ )	3.0 Max
Lead wire clinch height (H)	21.0 Max
Component height ( $H_1$ )	32.25 Max
Lead wire protrusion (l)	1.0 Max
Feed hole diameter ( $D_0$ )	4 $\pm$ 0.2
Total tape thickness (t)	0.5 $\pm$ 0.2
Length of clipped lead (L)	11.0 Max
Hole center to component center ( $P_2$ )	6.35 $\pm$ 1.3

Remark :  $P_0$  cumulative pitch error 1.0mm/20pitch.  $P_1$  to be measured at bottom of clinch.  $t$ : ground paper 0.5  $\pm$  0.1mm

## Avisert Type:

### Avisert type (3)

- Applicable to CFR 1/8W & 1/4W of Carbon Film Fixed Resistors and MFR 1/8W & 1/4W of Metal Film Fixed Resistors. It is ideal for automatic insertion

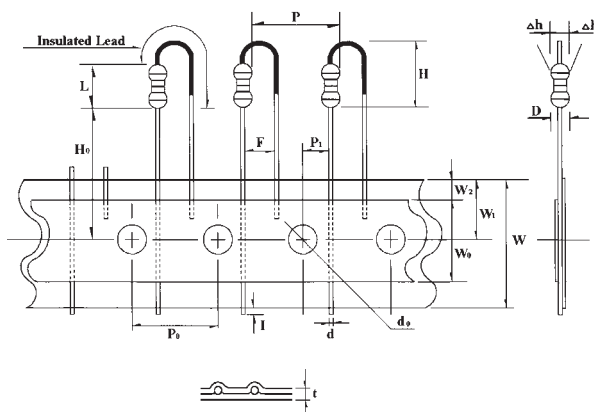

Body diameter (D)	1/8W: 2.0 Max 1/4W: 2.5 Max
Body Length (L)	1/8W: 4.2 Max 1/4W: 6.8Max
Body height (H)	1/8W: 7.0Max 1/4W: 10.0 Max
Lead-wire diameter (d)	1/8W: 0.5 (+0.02/-0.05) 1/4W: 0.6 (+0.02/-0.05)
Pitch of component (P)	12.7 ± 1
Lead to lead spacing (F)	1/8W: 2.5 ± 1; 1/4W: 5 ± 1
Feed hole pitch ( $P_0$ )	12.7 ± 0.3
Hole center to lead ( $P_1$ )	5.1 ± 0.5
Component alignment ( $\Delta h$ )	0 ± 0.1
Tape width (W)	18 ± 1
Hold down type width ( $W_0$ )	12.5 Min
Hole position ( $W_1$ )	9 ± 0.5
Hold down tape position ( $W_2$ )	3 Max
Lead wire clinch height ( $H_0$ )	16.5 Max
Length of sniped lead ( $L$ )	11.0 Max
Lead wire protrusion ( $l$ )	1.0 Max
Feed hole diameter ( $d_0$ )	4 ± 0.3
Total tape thickness (t)	0.5 ± 0.2

Remark :  $P_0$  cumulative pitch error 1.0mm / 20 pitch

### Ordering Procedure (Example: MFR 1/8W 1% 50PPM 221Ω T/R-5000 Avisert (3) Type)

**Special Features:** 0 = Standard product , F = Flame retardant , I = Non-inductive

**Tolerance (T.C.R.):** B = ± 0.1% (15PPM), C = ± 0.25% (25PPM), D = ± 0.5% (50PPM)  
F = ± 1% (50PPM), G = ± 2% (100PPM) , J = ± 5% (200PPM)

**Resistance Value:**  
E-24 series: The 1<sup>st</sup> digit will be "0"; the 2<sup>nd</sup> & 3<sup>rd</sup> digits are for the significant figures of the resistance and the 4<sup>th</sup> digit denotes number of zeros following.  
E-96 series: The 1<sup>st</sup> to 3<sup>rd</sup> digits are for the significant figures of the resistance and the 4<sup>th</sup> digit denotes number of zeros following

**Packing Type:** A = Tape / Box, T = Tape / Reel

**Packing Quantity:**  
2 = 2000(T/B only), 5 = 5000(T/R only)  
T/R is 2500pcs per reel & 2 reel per box

**Product Type:**  
CFR = Carbon Film  
Fixed Resistors  
MFR = Metal Film  
Fixed Resistors

**Wattage:**  
W8 = 1/8W  
W4 = 1/4W

**RADIAL Type:**  
1=Avisert Type 1, 2=Avisert Type 2, 3=Avisert Type 3

**M F R 0 W 8 F 2 2 1 0 T 5 3**

# M & F Formed Type

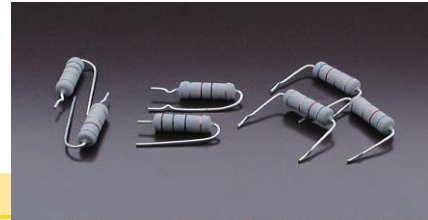

## F Formed Type

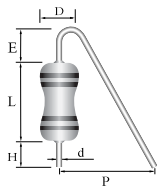

F Type



F1 Type



F2 Type



F3 Type

## Dimension & Specifications

Power Rating	L Max.	D Max.	d <sup>+0.02</sup> <sub>-0.05</sub>	P <sup>+1</sup> <sub>-3</sub>	H ± 1	E ± 0.5
1W (2W-S)	12	5.0	0.7	8	8	2.5
2W (3W-S)	16	5.5	0.8	8	6	2.5

• Above specification given for recommendation only, please consult factory for special required specifications

## Ordering Procedure (Example: CFR 2W-S 5% 100Ω B/B F1 Type)

**Special Features:** 0 = Standard product, F = Flame retardant, I = Non-inductive

**Tolerance (T.C.R.):** F = ± 1%, G = ± 2%, J = 5%, K = ± 10%

**Resistance Value:**

E-24 series :

The 1<sup>st</sup> digit will be "0";  
the 2<sup>nd</sup> & 3<sup>rd</sup> digits are  
for the significant  
figures of the  
resistance and the 4<sup>th</sup>  
digit denotes number  
of zeros following.

E-96 series – The 1<sup>st</sup> to  
3<sup>rd</sup> digits are for the  
significant figures of  
the resistance and the  
4<sup>th</sup> digit denotes  
number of zeros  
following

**Packing Type:** B = Bulk/Box Only

**Forming Type:**

F0 = F Type, F1 = F1 Type, F2 = F2 Type, F3 = F3 Type

**Product Type:**

- CFR = Carbon Film  
Fixed Resistors ,
- MFR = Metal Film  
Fixed Resistors
- MOR = Metal Oxide  
Resistors
- FRN = Fusible  
Resistors
- KNP = KNP Type  
Wire-Wound  
Resistors

**Wattage:**

- W2=½W
- 1W=1W
- 2W=2W
- 3W=3W
- 5W=5W
- 1S=1W-S
- 2S=2W-S
- 3S=3W-S
- 5S=5W-S

**C F R 0 2 S J 0 1 0 1 B F 1**



## M & F Formed Type

### M Formed Type

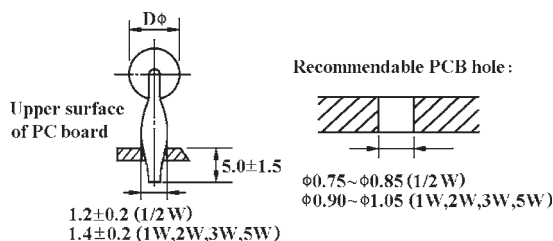
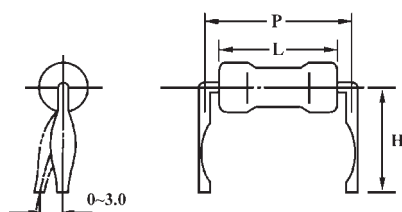

#### Normal Size

Power Rating At 70°C	Dimension (mm)				
	D Max.	L Max.	H ± 2	P	d $\begin{matrix} +0.02 \\ -0.05 \end{matrix}$
1/2W	4	10	14	13 ± 1.5	0.7
1W	5	12	14	15 ± 1.5	0.7
2W	5.5	16	18	20 ± 1.5	0.8
* 3W	6.5	17.5	20	25 ± 1.5	0.8
* 5W	8.5	26	20	31 ± 1.5	0.8

#### Small Size

Power Rating At 70°C	Dimension (mm)				
	D Max.	L Max.	H ± 2	P	d $\begin{matrix} +0.02 \\ -0.05 \end{matrix}$
1W	4	10	14	13 ± 1.5	0.7
2W	5	12	14	15 ± 1.5	0.7
3W	5.5	16	18	20 ± 1.5	0.8
5W	8	25	22	31 ± 1.5	0.8

\* Above specification given are recommended for MOR product only, please consult factory for the specification of other products

### Ordering Procedure (Example: MOR 1W-S 5% 10Ω B/B M Type with flattened lead wire)

**Special Features:** 0 = Standard product, F = Flame retardant, I = Non-inductive

**Tolerance (T.C.R.):** F = ± 1%, G = ± 2%, J = ± 5%, K = ± 10%

**Product Type:**

CFR = Carbon Film Fixed Resistors,  
MFR = Metal Film Fixed Resistors,  
MOR = Metal Oxide Film Fixed Resistors  
FRN = Fusible Resistors,  
KNP = KNP Type Wire-Wound Resistors

**Wattage:**

W2=1/2W  
1W=1W  
2W=2W  
3W=3W  
5W=5W  
1S=1W-S  
2S=2W-S  
3S=3W-S  
5S=5W-S

**Resistance Value:**

E-24 series: The 1<sup>st</sup> digit will be "0"; the 2<sup>nd</sup> & 3<sup>rd</sup> digits are for the significant figures of the resistance and the 4<sup>th</sup> digit denotes number of zeros following.  
E-96 series: The 1<sup>st</sup> to 3<sup>rd</sup> digits are for the significant figures of the resistance and the 4<sup>th</sup> digit denotes number of zeros following

**Packing Type:** B = Bulk/Box Only

**Forming Type:**

MF = M Type with flattened lead wire  
MK = M Type with kinked lead wire  
ML = M Type with normal lead wire

**M O R 0 1 S J 0 1 0 0 B M F**

# Standard Parcking of Coated Type Resistors

## Tape in Box Packing:

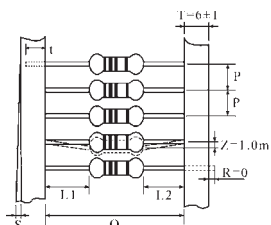
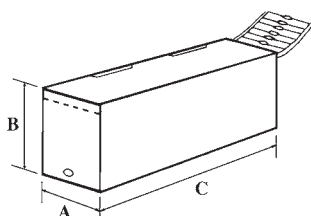

\*L1-L2=1.0 Max.  
(0 For Jumper Wire)  
\*\*S=0.5 Max.  
(0.8 Max. for PT-26)



Part No.	Type	Dimension of T/B (mm)					Qty / Box
		O	P	A ± 5	B ± 5	C ± 5	
<b>Carbon Film Fixed Resistors</b>							
CFR0W8	CFR-12	52±1	5±0.3	75	65	260	5,000
CFR0S4	CFR-25-S	52±1	5±0.3	75	65	260	5,000
CFR0W4	CFR-25	52±1	5±0.3	75	90	250	5,000
CFR0U2	CFR-50-SS	52±1	5±0.3	70	115	255	5,000
CFR0S2	CFR-50-S	52±1	5±0.3	70	60	255	2,000
CFR0W2	CFR-50	52±1	5±0.3	75	80	255	2,000
CFR01S	CFR-100-S	58±1	5±0.3	75	80	255	1,000
CFR01W	CFR-100	65±5	10±0.5	85	85	255	1,000
CFR02S	CFR-200-S	65±5	10±0.5	85	85	255	1,000
CFR02W	CFR-200	65±5	10±0.5	90	65	255	500
CFR03S	CFR-300-S	65±5	10±0.5	90	65	255	500
<b>Metal Film Fixed Resistors</b>							
MFR0W8	MF-12	52±1	5±0.3	75	65	260	5,000
MFR0S4	MF-25-S	52±1	5±0.3	75	65	260	5,000
MFR0W4	MF-25	52±1	5±0.3	75	90	250	5,000
MFR004	MF-40-SS	52±1	5±0.3	75	65	260	5,000
MFR0U2	MF-50-SS	52±1	5±0.3	70	115	255	5,000
MFR0S2	MF-50-S	52±1	5±0.3	70	60	255	2,000
MFR0W2	MF-50	52±1	5±0.3	75	80	255	2,000
MFR006	MF-60-S	52±1	5±0.3	70	115	255	5,000
MFR01W	MF-100	58±1	5±0.3	75	80	255	1,000
MFR02W	MF-200	65±5	10±0.5	85	85	255	1,000
MFR03W	MF-300	65±5	10±0.5	90	65	255	500
<b>Metal Oxide Film Fixed Resistors</b>							
MOR0W4	MOR-25	52±1	5±0.3	70	115	255	5,000
MOR0S2	MOR-50-S	52±1	5±0.3	70	115	255	5,000
MOR0W2	MOR-50	52±1	5±0.3	85	120	255	2,000
MOR01S	MOR-100-S	58±1	5±0.3	85	120	255	2,000
MOR01W	MOR-100	58±1	5±0.3	75	80	255	1,000
MOR02S	MOR-200-S	58±1	5±0.3	75	80	255	1,000
MOR02W	MOR-200	65±1	10±0.5	90	90	255	1,000
MOR03S	MOR-300-S	65±1	10±0.5	90	90	255	1,000
MOR03W	MOR-300	65±5	10±0.5	80	75	260	500
MOR05U	MOR-500-SS	65±5	10±0.5	80	75	260	500
MOR05S	MOR-500-S	90±5	10±0.5	110	120	500	500

## Standard Parcking of Coated Type Resistors

Part No.	Type	Dimension of T/B (mm)					Qty / Box
		O	P	A ± 5	B ± 5	C ± 5	
<b>Fusible Resistors</b>							
FRN0W4	FRN-25	52±1	5±0.3	70	115	255	5,000
FRN0W2	FRN-50	52±1	5±0.3	75	60	255	2,000
FRN01W	FRN-100	58±1	5±0.3	85	120	255	1,000
FRN02W	FRN-200	58±1	5±0.3	75	80	255	1,000
FRN03W	FRN-300	65±5	10±0.5	90	90	255	1,000
<b>Wired-Wound Fixed Resistors</b>							
KNP0W2	KNP-50	58±1	5±0.3	75	80	255	1,000
KNP01S	KNP-100-S	58±1	5±0.3	75	80	255	1,000
KNP01W	KNP-100	58±1	10±0.5	75	80	255	1,000
KNP02S	KNP-200-S	58±1	10±0.5	75	80	255	1,000
KNP02W	KNP-200	65±5	10±0.5	90	90	255	1,000
KNP03S	KNP-300-S	65±5	10±0.5	90	90	255	1,000
KNP03W	KNP-300	65±5	10±0.5	80	75	260	500
KNP05S	KNP-500-S	65±5	10±0.5	80	75	260	500
<b>500Jumper Wire &amp; Zero Ohm</b>							
ZWA0	ZW-A	52±1	5±0.3	70	115	255	10,000
ZWB0	ZW-B	52±1	5±0.3	70	115	255	10,000
ZWC0	ZW-C	52±1	5±0.3	70	115	255	8,000
ZWD0	ZW-D	52±1	5±0.3	70	115	255	8,000
ZO0W8	ZO-12	52±1	5±0.3	75	65	260	5,000
ZO0W4	ZO-25	52±1	5±0.3	75	90	260	5,000
<b>PT-26 Type</b>							
CFR0W8	CFR-12	26 <sup>+1.5</sup> <sub>-1</sub>	5±0.5	50	68	257	5,000
CFR0S4	CFR-25-S	26 <sup>+1.5</sup> <sub>-1</sub>	5±0.5	50	68	257	5,000
CFR0W4	CFR-25	26 <sup>+1.5</sup> <sub>-0</sub>	5±0.5	50	95	257	5,000
CFR0U2	CFR-50-SS	26 <sup>+1.5</sup> <sub>-0</sub>	5±0.5	50	95	257	5,000
MFR0W8	MF-12	26 <sup>+1.5</sup> <sub>-1</sub>	5±0.5	50	68	257	5,000
MFR0S4	MF-25-S	26 <sup>+1.5</sup> <sub>-1</sub>	5±0.5	50	68	257	5,000
MFR0W4	MF-25	26 <sup>+1.5</sup> <sub>-0</sub>	5±0.5	50	95	257	5,000
MFR0U2	MF-50-SS	26 <sup>+1.5</sup> <sub>-0</sub>	5±0.5	50	95	257	5,000
MFR006	MF-60-S	26 <sup>+1.5</sup> <sub>-0</sub>	5±0.5	50	95	257	5,000

# Standard Parcking of Coated Type Resistors

## Tape in Reel Packing

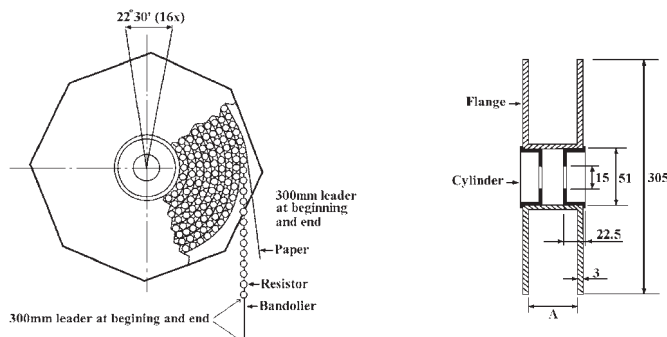

Part No.	Type	Dimension of Reel (mm)				Qty / Box
		A	W	H	L	
<b>Carbon Film Fixed Resistors</b>						
CFR0W8	CFR-12	73±2	85	305	290	5,000
CFR0S4	CFR-25-S	73±2	85	305	290	5,000
CFR0W4	CFR-25	73±2	85	305	290	5,000
CFR0U2	CFR-50-SS	73±2	85	305	290	5,000
CFR0S2	CFR-50-S	73±2	85	305	290	4,000
CFR0W2	CFR-50	73±2	85	305	290	2,500
CFR01S	CFR-100-S	73±2	85	305	290	2,500
CFR01W	CFR-100	80±5	95	295	290	1,000
CFR02S	CFR-200-S	80±5	95	295	290	1,000
CFR02W	CFR-200	80±5	105	300	290	1,000
CFR03S	CFR-300-S	80±5	105	300	290	1,000
<b>Metal Film Fixed Resistors</b>						
MFR0W8	MF-12	73±2	85	305	290	5,000
MFR0S4	MF-25-S	73±2	85	305	290	5,000
MFR0W4	MF-25	73±2	85	305	290	5,000
MFR004	MF-40-SS	73±2	85	305	290	5,000
MFR0U2	MF-50-SS	73±2	85	305	290	5,000
MFR0S2	MF-50-S	73±2	85	305	290	4,000
MFR0W2	MF-50	73±2	85	305	290	2,500
MFR006	MF-60-S	73±2	85	305	290	5,000
MFR01W	MF-100	73±2	85	305	290	2,500
MFR02W	MF-200	80±5	95	295	290	1,000
MFR03W	MF-300	80±5	105	300	290	1,000
<b>Metal Oxide Film Fixed Resistors</b>						
MOR0W4	MOR-25	73±2	85	305	290	5,000
MOR0S2	MOR-50-S	73±2	85	305	290	5,000
MOR0W2	MOR-50	73±2	85	305	290	2,500
MOR01S	MOR-100-S	73±2	85	305	290	2,500
MOR01W	MOR-100	73±2	85	305	290	2,500
MOR02S	MOR-200-S	73±2	85	305	290	2,500
MOR02W	MOR-200	80±5	95	295	290	1,000
MOR03S	MOR-300-S	80±5	95	295	290	1,000
MOR03W	MOR-300	80±5	105	300	290	1,000
MOR05U	MOR-500-SS	80±5	105	300	290	1,000

# Standard Packing of Coated Type Resistors

## Bulk in Box Packing:

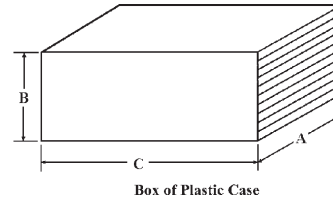
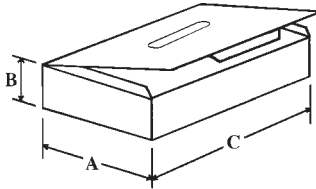

Part No.	Type	Dimension of Box (mm)			Qty. Of Bag/Box
		A ± 5	B ± 5	C ± 5	
<b>Carbon Film Fixed Resistors</b>					
CFR0W8	CFR-12	55	55	155	1,000 / 5,000
CFR0S4	CFR-25-S	55	55	155	1,000 / 5,000
CFR0W4	CFR-25	75	35	150	500 / 1,000
CFR0U2	CFR-50-SS	75	35	150	250 / 1,000
CFR0S2	CFR-50-S	75	35	150	250 / 1,000
CFR0W2	CFR-50	75	65	150	200 / 1,000
CFR01S	CFR-100-S	75	65	150	100 / 500
CFR01W	CFR-100	95	55	155	100 / 400
CFR02S	CFR-200-S	95	55	155	100 / 400
CFR02W	CFR-200	95	55	155	100 / 300
CFR03S	CFR-300-S	95	55	155	100 / 300
<b>Metal Film Fixed Resistors</b>					
MFR0W8	MF-12	55	55	155	1,000 / 5,000
MFR0S4	MF-25-S	55	55	155	1,000 / 5,000
MFR0W4	MF-25	75	35	150	500 / 1,000
MFR004	MF-40-SS	55	55	155	1,000 / 5,000
MFR0U2	MF-50-SS	75	35	150	250 / 1,000
MFR0S2	MF-50-S	75	35	150	500 / 1,000
MFR0W2	MF-50	75	65	150	200 / 1,000
MFR006	MF-60-S	75	35	150	250 / 1,000
MFR01W	MF-100	75	65	150	100 / 500
MFR02W	MF-200	95	55	155	100 / 400
MFR03W	MF-300	95	55	155	100 / 300
<b>Metal Oxide Film Fixed Resistors</b>					
MOR0W4	MOR-25	75	35	150	250 / 1,000
MOR0S2	MOR-50-S	75	35	150	250 / 1,000
MOR0W2	MOR-50	75	65	150	200 / 1,000
MOR01S	MOR-100-S	95	55	155	100 / 1,000
MOR01W	MOR-100	95	55	155	500 / 1,000
MOR02S	MOR-200-S	95	55	155	500 / 1,000
MOR02W	MOR-200	95	55	155	100 / 400
MOR03S	MOR-300-S	95	55	155	100 / 400
MOR03W	MOR-300	95	55	155	100 / 300
MOR05U	MOR-500-SS	95	55	155	100 / 300
**MOR05S	MOR-500-S	185	95	365	1,000
**MOR05W	MOR-500	185	95	365	1,000
MOR07W	MOR-700	170	110	200	25 / 400

## Test Methods of JIS-C-5202:

Temperature coefficient: (JIS-C-5202 5.2)	Natural resistance change per temperature degree centigrade: $\frac{R_2 - R_1}{R_1(t_2 - t_1)} \times 10^6 \text{ (PPM / } ^\circ\text{C)}$ <p><math>R_1</math>: Resistance value at room temperature (<math>t_1</math>);  <math>R_2</math>: Resistance value at room temperature plus 100 °C (<math>t_2</math>).            Test pattern: Room temperature (<math>t_1</math>), Room temperature + 100 °C (<math>t_2</math>).</p>
Short-time overload: (JIS-C-5202 5.5)	Permanent resistance change after the application of a potential of 2.5 times RCWV for 5 seconds.
Insulation resistance: (JIS-C-5202 5.6)	Apply 500V DC between protective coating and termination for 1 min., then measure. (100V DC especially for Resistor Network)
Dielectric withstanding voltage: (JIS-C-5202 5.7)	Resistors shall be clamped in the trough of a 90 °C metallic V – block and shall be tested at AC potential respectively specified in the given list of each product type for 60 – 70 seconds. For Cement Fixed Resistors, the testing voltage is 1,000 volts.
Pulse overload: (JIS-C 5202 5.8)	Resistance change after 10,000 cycles (1 seconds “ON”, 25 seconds “OFF”) at 4 times of RCWV or max. RCWV whichever less.
Terminal strength: (JIS-C 5202 6.1)	<b>Direct Load:</b> Resistance to a 2.5kg direct load for 10 seconds in the direction of the longitudinal axis of the terminal leads. <b>Twist Test:</b> Terminal leads shall be bent through 90° at a point of about 6mm from the body of the resistor and shall be rotated through 360° about the original axis of the bent terminal in alternating direction for a total of 3 rotations.
Terminal strength: (JIS-C 5202 6.1)	(Applicable for Resistor Network) Tensile: 1KG, 30 seconds; Bending: 500g, 2 times.
Terminal bending: (JIS-C 5202 6.1.4)	(Applicable for CHIP resistors) Twist of Test Board: Y/X = 3/90mm for 10 seconds.
Soldering heat: (JIS-C 5202 6.4)	(Applicable for CHIP resistors) Dip the resistor into a solder bath having a temp. of 260± 5 °C and hold it for 10±1 seconds.
Resistance to soldering heat: (JIS-C 5202 6.4)	Permanent resistance change when leads immersed to a point 2.0~2.5mm from the body in 350±10 °C solder for 3~4 seconds.
Solderability: (JIS-C 5202 6.5)	The area covered with a new, smooth, clean, shiny and continuous surface free from concentrated pinholes. Test temperature of solder: 235±5 °C; Dwell time in solder: 3~3.5 seconds.
Resistance to solvent: (JIS-C 5202 6.9)	Specimens shall be immersed in a bath of alcohol completely for 3 minutes using ultrasonic test equipment.
Thermal shock: (JIS-C 5202 7.3)	(Applicable for Resistor Network) Load V, Room temperature, 30 minutes. Unload, -55 °C, 15 minutes. Over 2 hours in room temperature before measuring.
Temperature cycling: (JIS-C 5202 7.4)	Resistance change after continuous 5 cycles for duty cycle specified below Step 1: 30 minutes at -55±3 °C Step 2: 10~15 minutes at Room temperature Step 3: 30 minutes at 155±2 °C Step 4: 10~15 minutes at Room temperature
Humidity (Steady state): (JIS-C 5202 7.5)	Temporary resistance change after 240 hours exposure in a humidity test chamber controlled at 40±2 °C and 90~95% relative humidity.
Load life in humidity: (JIS-C 5202 7.9)	Resistance change after 1,000 hours (1.5 hours “ON”, 0.5 hours “OFF”) at RCWV or max. RCWV whichever less in a humidity test chamber controlled at 40±2 °C and 90~95% relative humidity.
Load life: (JIS-C 5202 7.10)	Permanent resistance change after 1,000 hours operating at RCWV or max. RCWV whichever less with duty cycle of 1.5 hours “ON”, 0.5 hour “OFF” at 70±2 °C ambient.
Flame retardant: (JIS-C 5202 7.12)	Resistors shall resist flaming or arcing when overload up to 16 times RCWV or max. RCWV whichever less.
Flame retardant: (JIS-C 5202 7.12)	(Applicable for Fusing Resistor) The burner is placed remote from resistor ignited and adjusted to produce a blue flame 38mm in height and a top of flame 127mm above the top of burner tube. Resistor is supported from its lead at 45° from the horizontal so that the lower end of resistor is the top of blue flame. The test flame is placed to remain for 15 seconds and removed for 15 seconds. The operation is to be repeated until resistor has been subjected to 5 application of test flame.

\*\* RCWV = Rated Continuous Working Voltage =  $\sqrt{\text{Rated Power} \times \text{Resistance Value}}$

## Standard Nominal Resistance Values:

The below chart shows the nominal resistance value for each series. The values in the chart have been in this order using the approximate values that are based on the common ratios given in the following table:

Series	Common Ratio	Remarks
E-6	$\sqrt[6]{10}$ (1.46)	Rounded off to a 2-digit figure
E-12	$\sqrt[12]{10}$ (1.21)	
E-24	$\sqrt[24]{10}$ (1.10)	
E-96	$\sqrt[96]{10}$ (1.02)	Rounded off to a 3-digit figure

E-6	E-12	E-24	E-96	E-6	E-12	E-24	E-96	E-6	E-12	E-24	E-96						
1.0	1.0	1.0	1.00	2.2	2.2	2.2	2.15	4.7	4.7	4.7	4.64						
			1.02				2.21				4.75						
			1.05				2.26				4.87						
			1.07				2.32				4.99						
		1.1	1.10			2.4	2.37				5.1	5.11					
			1.13				2.43					5.23					
			1.15				2.49					5.36					
			1.18				2.55					5.49					
	1.2	1.2	1.2	1.21	2.7	2.7	2.61			5.6	5.62						
				1.24			2.67				5.76						
				1.27			2.74				5.90						
				1.30			2.80				6.04						
		1.3	1.3	1.3		1.33	3.0				3.0	2.87	6.2	6.19			
						1.37						2.94		6.34			
						1.40						3.01		6.49			
						1.43						3.09		6.65			
	1.5	1.5	1.5	1.47	3.3	3.3	3.16			6.8	6.8	6.8	6.81				
				1.50			3.24						6.98				
				1.54			3.32						7.15				
				1.58			3.40						7.32				
			1.6	1.6		1.6	1.62						3.6	3.6	3.48	7.5	7.50
							1.65								3.57		7.68
							1.69								3.65		7.87
							1.74								3.74		8.06
1.8		1.8	1.8	1.78	3.9	3.9	3.83	8.2	8.2			8.25					
				1.82			3.92					8.45					
				1.87			4.02					8.66					
				1.91			4.12					8.87					
		2.0	2.0	2.0		1.96	4.3		4.3			4.22	9.1	9.09			
						2.00						4.32		9.31			
						2.05						4.42		9.53			
						2.10						4.53		9.76			

# Standard Nominal Resistance Values:

**E-24 series standard resistance values & the codes to be used in the part No. system (4 digits):**

VALUE	CODE	VALUE	CODE	VALUE	CODE	VALUE	CODE	VALUE	CODE	VALUE	CODE	VALUE	CODE
1.0Ω	010J	10Ω	0100	100Ω	0101	1.0KΩ	0102	10KΩ	0103	100KΩ	0104	1.0MΩ	0105
1.1Ω	011J	11Ω	0110	110Ω	0111	1.1KΩ	0112	11KΩ	0113	110KΩ	0114	1.1MΩ	0115
1.2Ω	012J	12Ω	0120	120Ω	0121	1.2KΩ	0122	12KΩ	0123	120KΩ	0124	1.2MΩ	0125
1.3Ω	013J	13Ω	0130	130Ω	0131	1.3KΩ	0132	13KΩ	0133	130KΩ	0134	1.3MΩ	0135
1.5Ω	015J	15Ω	0150	150Ω	0151	1.5KΩ	0152	15KΩ	0153	150KΩ	0154	1.5MΩ	0155
1.6Ω	016J	16Ω	0160	160Ω	0161	1.6KΩ	0162	16KΩ	0163	160KΩ	0164	1.6MΩ	0165
1.8Ω	018J	18Ω	0180	180Ω	0181	1.8KΩ	0182	18KΩ	0183	180KΩ	0184	1.8MΩ	0185
2.0Ω	020J	20Ω	0200	200Ω	0201	2.0KΩ	0202	20KΩ	0203	200KΩ	0204	2.0MΩ	0205
2.2Ω	022J	22Ω	0220	220Ω	0221	2.2KΩ	0222	22KΩ	0223	220KΩ	0224	2.2MΩ	0225
2.4Ω	024J	24Ω	0240	240Ω	0241	2.4KΩ	0242	24KΩ	0243	240KΩ	0244	2.4MΩ	0245
2.7Ω	027J	27Ω	0270	270Ω	0271	2.7KΩ	0272	27KΩ	0273	270KΩ	0274	2.7MΩ	0275
3.0Ω	030J	30Ω	0300	300Ω	0301	3.0KΩ	0302	30KΩ	0303	300KΩ	0304	3.0MΩ	0305
3.3Ω	033J	33Ω	0330	330Ω	0331	3.3KΩ	0332	33KΩ	0333	330KΩ	0334	3.3MΩ	0335
3.6Ω	036J	36Ω	0360	360Ω	0361	3.6KΩ	0362	36KΩ	0363	360KΩ	0364	3.6MΩ	0365
3.9Ω	039J	39Ω	0390	390Ω	0391	3.9KΩ	0392	39KΩ	0393	390KΩ	0394	3.9MΩ	0395
4.3Ω	043J	43Ω	0430	430Ω	0431	4.3KΩ	0432	43KΩ	0433	430KΩ	0434	4.3MΩ	0435
4.7Ω	047J	47Ω	0470	470Ω	0471	4.7KΩ	0472	47KΩ	0473	470KΩ	0474	4.7MΩ	0475
5.1Ω	051J	51Ω	0510	510Ω	0511	5.1KΩ	0512	51KΩ	0513	510KΩ	0514	5.1MΩ	0515
5.6Ω	056J	56Ω	0560	560Ω	0561	5.6KΩ	0562	56KΩ	0563	560KΩ	0564	5.6MΩ	0565
6.2Ω	062J	62Ω	0620	620Ω	0621	6.2KΩ	0622	62KΩ	0623	620KΩ	0624	6.2MΩ	0625
6.8Ω	068J	68Ω	0680	680Ω	0681	6.8KΩ	0682	68KΩ	0683	680KΩ	0684	6.8MΩ	0685
7.5Ω	075J	75Ω	0750	750Ω	0751	7.5KΩ	0752	75KΩ	0753	750KΩ	0754	7.5MΩ	0755
8.2Ω	082J	82Ω	0820	820Ω	0821	8.2KΩ	0822	82KΩ	0823	820KΩ	0824	8.2MΩ	0825
9.1Ω	091J	91Ω	0910	910Ω	0911	9.1KΩ	0912	91KΩ	0913	910KΩ	0914	9.1MΩ	0915
												10MΩ	0106

**E-96 series standard resistance values & the codes to be used in the part No. system (4 digits):**

VALUE	CODE	VALUE	CODE	VALUE	CODE	VALUE	CODE	VALUE	CODE	VALUE	CODE	VALUE	CODE		
10.0Ω	100J	17.8Ω	178J	31.6Ω	316J	56.2Ω	562J	100Ω	1000	178Ω	1780	316Ω	3160	562Ω	5620
10.2Ω	102J	18.2Ω	182J	32.4Ω	324J	57.6Ω	576J	102Ω	1020	182Ω	1820	324Ω	3240	576Ω	5760
10.5Ω	105J	18.7Ω	187J	33.2Ω	332J	59.0Ω	590J	105Ω	1050	187Ω	1870	332Ω	3320	590Ω	5900
10.7Ω	107J	19.1Ω	191J	34.0Ω	340J	60.4Ω	604J	107Ω	1070	191Ω	1910	340Ω	3400	604Ω	6040
11.0Ω	110J	19.6Ω	196J	34.8Ω	348J	61.9Ω	619J	110Ω	1100	196Ω	1960	348Ω	3480	619Ω	6190
11.3Ω	113J	20.0Ω	200J	35.7Ω	357J	63.4Ω	634J	113Ω	1130	200Ω	2000	357Ω	3570	634Ω	6340
11.5Ω	115J	20.5Ω	205J	36.5Ω	365J	64.9Ω	649J	115Ω	1150	205Ω	2050	365Ω	3650	649Ω	6490
11.8Ω	118J	21.0Ω	210J	37.4Ω	374J	66.5Ω	665J	118Ω	1180	210Ω	2100	374Ω	3740	665Ω	6650
12.1Ω	121J	21.5Ω	215J	38.3Ω	383J	68.1Ω	681J	121Ω	1210	215Ω	2150	383Ω	3830	681Ω	6810
12.4Ω	124J	22.1Ω	221J	39.2Ω	392J	69.8Ω	698J	124Ω	1240	221Ω	2210	392Ω	3920	698Ω	6980
12.7Ω	127J	22.6Ω	226J	40.2Ω	402J	71.5Ω	715J	127Ω	1270	226Ω	2260	402Ω	4020	715Ω	7150
13.0Ω	130J	23.2Ω	232J	41.2Ω	412J	73.2Ω	732J	130Ω	1300	232Ω	2320	412Ω	4120	732Ω	7320
13.3Ω	133J	23.7Ω	237J	42.2Ω	422J	75.0Ω	750J	133Ω	1330	237Ω	2370	422Ω	4220	750Ω	7500
13.7Ω	137J	24.3Ω	243J	43.2Ω	432J	76.8Ω	768J	137Ω	1370	243Ω	2430	432Ω	4320	768Ω	7680
14.0Ω	140J	24.9Ω	249J	44.2Ω	442J	78.7Ω	787J	140Ω	1400	249Ω	2490	442Ω	4420	787Ω	7870
14.3Ω	143J	25.5Ω	255J	45.3Ω	453J	80.6Ω	806J	143Ω	1430	255Ω	2550	453Ω	4530	806Ω	8060
14.7Ω	147J	26.1Ω	261J	46.4Ω	464J	82.5Ω	825J	147Ω	1470	261Ω	2610	464Ω	4640	825Ω	8250
15.0Ω	150J	26.7Ω	267J	47.5Ω	475J	84.5Ω	845J	150Ω	1500	267Ω	2670	475Ω	4750	845Ω	8450
15.4Ω	154J	27.4Ω	274J	48.7Ω	487J	86.6Ω	866J	154Ω	1540	274Ω	2740	487Ω	4870	866Ω	8660
15.8Ω	158J	28.0Ω	280J	49.9Ω	499J	88.7Ω	887J	158Ω	1580	280Ω	2800	499Ω	4990	887Ω	8870
16.2Ω	162J	28.7Ω	287J	51.1Ω	511J	90.9Ω	909J	162Ω	1620	287Ω	2870	511Ω	5110	909Ω	9090
16.5Ω	165J	29.4Ω	294J	52.3Ω	523J	93.1Ω	931J	165Ω	1650	294Ω	2940	523Ω	5230	931Ω	9310
16.9Ω	169J	30.1Ω	301J	53.6Ω	536J	95.3Ω	953J	169Ω	1690	301Ω	3010	536Ω	5360	953Ω	9530
17.4Ω	174J	30.9Ω	309J	54.9Ω	549J	97.6Ω	976J	174Ω	1740	309Ω	3090	549Ω	5490	976Ω	9760



## Standard Nominal Resistance Values:

VALUE	CODE	VALUE	CODE	VALUE	CODE	VALUE	CODE	VALUE	CODE	VALUE	CODE	VALUE	CODE	VALUE	CODE
1.00K	1001	2.37K	2371	5.62K	5621	13.3K	1332	31.6K	3162	75.0K	7502	178K	1783	422K	4223
1.02K	1021	2.43K	2431	5.76K	5761	13.7K	1372	32.4K	3242	76.8K	7682	182K	1823	432K	4323
1.05K	1051	2.49K	2491	5.90K	5901	14.0K	1402	33.2K	3322	78.7K	7872	187K	1873	442K	4423
1.07K	1071	2.55K	2551	6.04K	6041	14.3K	1432	34.0K	3402	80.6K	8062	191K	1913	453K	4533
1.10K	1101	2.61K	2611	6.19K	6191	14.7K	1472	34.8K	3482	82.5K	8252	196K	1963	464K	4643
1.13K	1131	2.67K	2671	6.34K	6341	15.0K	1502	35.7K	3572	84.5K	8452	200K	2003	475K	4753
1.15K	1151	2.74K	2741	6.49K	6491	15.4K	1542	36.5K	3652	86.6K	8662	205K	2053	487K	4873
1.18K	1181	2.80K	2801	6.65K	6651	15.8K	1582	37.4K	3742	88.7K	8872	210K	2103	499K	4993
1.21K	1211	2.87K	2871	6.81K	6811	16.2K	1622	38.3K	3832	90.9K	9092	215K	2153	511K	5113
1.24K	1241	2.94K	2941	6.98K	6981	16.5K	1652	39.2K	3922	93.1K	9312	221K	2213	523K	5233
1.27K	1271	3.01K	3011	7.15K	7151	16.9K	1692	40.2K	4022	95.3K	9532	226K	2263	536K	5363
1.30K	1301	3.09K	3091	7.32K	7321	17.4K	1742	41.2K	4122	97.6K	9762	232K	2323	549K	5493
1.33K	1331	3.16K	3161	7.50K	7501	17.8K	1782	42.2K	4222	100K	1003	237K	2373	562K	5623
1.37K	1371	3.24K	3241	7.68K	7681	18.2K	1822	43.2K	4322	102K	1023	243K	2433	576K	5763
1.40K	1401	3.32K	3321	7.87K	7871	18.7K	1872	44.2K	4422	105K	1053	249K	2493	590K	5903
1.43K	1431	3.40K	3401	8.06K	8061	19.1K	1912	45.3K	4532	107K	1073	255K	2553	604K	6043
1.47K	1471	3.48K	3481	8.25K	8251	19.6K	1962	46.4K	4642	110K	1103	261K	2613	619K	6193
1.50K	1501	3.57K	3571	8.45K	8451	20.0K	2002	47.5K	4752	113K	1133	267K	2673	634K	6343
1.54K	1541	3.65K	3651	8.66K	8661	20.5K	2052	48.7K	4872	115K	1153	274K	2743	649K	6493
1.58K	1581	3.74K	3741	8.87K	8871	21.0K	2102	49.9K	4992	118K	1183	280K	2803	665K	6653
1.62K	1621	3.83K	3831	9.09K	9091	21.5K	2152	51.1K	5112	121K	1213	287K	2873	681K	6813
1.65K	1651	3.92K	3921	9.31K	9311	22.1K	2212	52.3K	5232	124K	1243	294K	2943	698K	6983
1.69K	1691	4.02K	4021	9.53K	9531	22.6K	2262	53.6K	5362	127K	1273	301K	3013	715K	7153
1.74K	1741	4.12K	4121	9.76K	9761	23.2K	2322	54.9K	5492	130K	1303	309K	3093	732K	7323
1.78K	1781	4.22K	4221	10.0K	1002	23.7K	2372	56.2K	5622	133K	1333	316K	3163	750K	7503
1.82K	1821	4.32K	4321	10.2K	1022	24.3K	2432	57.6K	5762	137K	1373	324K	3243	768K	7683
1.87K	1871	4.42K	4421	10.5K	1052	24.9K	2492	59.0K	5902	140K	1403	332K	3323	787K	7873
1.91K	1911	4.53K	4531	10.7K	1072	25.5K	2552	60.4K	6042	143K	1433	340K	3403	806K	8063
1.96K	1961	4.64K	4641	11.0K	1102	26.1K	2612	61.9K	6192	147K	1473	348K	3483	825K	8253
2.00K	2001	4.75K	4751	11.3K	1132	26.7K	2672	63.4K	6342	150K	1503	357K	3573	845K	8453
2.05K	2051	4.87K	4871	11.5K	1152	27.4K	2742	64.9K	6492	154K	1543	365K	3653	866K	8663
2.10K	2101	4.99K	4991	11.8K	1182	28.0K	2802	66.5K	6652	158K	1583	374K	3743	887K	8873
2.15K	2151	5.11K	5111	12.1K	1212	28.7K	2872	68.1K	6812	162K	1623	383K	3833	909K	9093
2.21K	2211	5.23K	5231	12.4K	1242	29.4K	2942	69.8K	6982	165K	1653	392K	3923	931K	9313
2.26K	2261	5.36K	5361	12.7K	1272	30.1K	3012	71.5K	7152	169K	1693	402K	4023	953K	9533
2.32K	2321	5.49K	5491	13.0K	1302	30.9K	3092	73.2K	7322	174K	1743	412K	4123	976K	9763
														1M	1004

\*\* All values shown above are standard resistance values, other values could also be provided on a case to case basis.

# Explanation of Part No. System:



The standard Part No. includes 14 digits with the following explanation:

1. 1<sup>st</sup> ~ 4<sup>th</sup> digits:
  - a) This is to indicate the Chip Resistor size. Example: 1206, 0805 or 0603;
  - b) For Network Resistor & Coated type, the 1<sup>st</sup> to 3<sup>rd</sup> digits are to indicate the product type and the 4<sup>th</sup> digit is the special feature. Example: RNLA = Resistor Network Circuit A type; CFRF = Carbon Film Fixed Resistors Non Flame type; MORI = Metal Oxide Film Fixed Resistors Non-Inductive type.
  - c) For Cement Fixed Resistors, these 4 digits are to indicate the product type but if the product type has only 3 digits, the 4<sup>th</sup> digit will be "0". Example: PRW0=PRW type; PRWC=PRWC type.
2. 5<sup>th</sup> ~ 6<sup>th</sup> digits:
  - a) This is to indicate the wattage or power rating. To distinguish the sizes and the numbers, the following codes are used; and please refer to the following chart for details:  
W = Normal Size; S = Small Size; U = Extra Small Size; And "1" ~ "G" to denotes "1" ~ "16" as Hexadecimal:

1/16W ~ 1/2W (<1W)																
Wattage		1/2	1/3	1/4	1/5	1/6	1/7	1/8	1/9	1/10	1/11	1/12	1/13	1/14	1/15	1/16
Normal Size		W2	W3	W4	W5	W6	W7	W8	W9	WA	WB	WC	WD	WE	WF	WG
Small Size		S2	S3	S4	S5	S6	S7	S8	S9	SA	SB	SC	SD	SE	SF	SG
Extra Small Size		U2	U3	U4	U5	U6	U7	U8	U9	UA	UB	UC	UD	UE	UF	UG

1W ~ 16W (≥1W)																
Wattage	1	2	3	4	5	6	7	8	9	10	11	12	13	14	15	16
Normal Size	1W	2W	3W	4W	5W	6W	7W	8W	9W	AW	BW	CW	DW	EW	FW	GW
Small Size	1S	2S	3S	4S	5S	6S	7S	8S	9S	AS	BS	CS	DS	ES	FS	GS
Extra Small Size	1U	2U	3U	4U	5U	6U	7U	8U	9U	AU	BU	CU	DU	EU	FU	GU

- b) For power rating less than 1 watt, the 5<sup>th</sup> digit will be the letters W, S or U to represent the size required & the 6<sup>th</sup> digit will be a number or a letter code. Example: WA = 1/10W; U2 = 1/2W-SS.
  - c) For power rating of 1watt to 16 watt, the 5<sup>th</sup> digit will be a number or a letter code and the 6<sup>th</sup> digit will be the letters of W, S or U. Example: AW = 10W; 3S = 3W-S.
  - d) For power rating between 20 watt to 99 watt, the 5<sup>th</sup> and the 6<sup>th</sup> digits will show the whole numbers of the power rating itself. Example: 20 = 20W; 75 = 75W.
  - e) For power rating of 100W and over, the 5<sup>th</sup> & the 6<sup>th</sup> digits will be indicated with "00" and the actual wattage being indicated at the last 3 digits (12<sup>th</sup> ~ 14<sup>th</sup>) of the part No.
  - f) For special power ratings, the following codes are to be used:
    - 1). WH = 1/32W (Chip Network 10P8)
    - 2). 07 = 3/4-S (CHIP 2010)
    - 3). 04 = 0.4W-SS (0.4 watt Extra Small Size)
    - 4). 06 = 0.6W-S (0.6watt Small Size)
    - 5). 2A = 2.5W
    - 6). 6A = 6.5W
  - g) For Resistor Network, since the power rating is fixed as 1/8W for A circuit & 1/5W for B circuit, the 5<sup>th</sup> & 6<sup>th</sup> digit is to be used to denote the number of pins required. Example: 09 = 9pins; 12 = 12pins.
  - h) For Jumper Wire resistors, the 5<sup>th</sup> & 6<sup>th</sup> digits will be indicated with "00".
3. The 7<sup>th</sup> digit is to denote the Resistance Tolerance. The following letter code is to be used for indicating the standard Resistance Tolerance. As for Metal Film Fixed Resistor products, it is also to denote the standard PPM as follows:

<b>B</b> = ±0.1%	(15PPM)	<b>G</b> = ±2%	(100PPM)
<b>C</b> = ±0.25%	(25PPM)	<b>J</b> = ±5%	(200PPM)
<b>D</b> = ±0.5%	(50PPM)	<b>K</b> = ±10%	
<b>F</b> = ±1%	(50PPM)		

**Remark:** if it is not one of the above standard "tolerance-PPM", the requirement should be clearly stated when placing order.  
Example: ±1% (25PPM), the 7<sup>th</sup> digit still shows "F" but separately note that requirement of 25PPM.

## Explanation of Part No. System:

4. The 8<sup>th</sup> to 11<sup>th</sup> digits is to denote the Resistance Value.

- For the standard resistance values of E-24 series, the 8<sup>th</sup> digit is "0", the 9<sup>th</sup> & 10<sup>th</sup> digits are to denote the significant figures of the resistance and the 11<sup>th</sup> digit is the number of zeros following.
- For the standard resistance values of E-96 series, the 8<sup>th</sup> digit to the 10<sup>th</sup> digit is to denote the significant figures of the resistance and the 11<sup>th</sup> digit is the zeros following.
- For the code of the significant figures of E-24 & E-96 series, please refer to page 50 & 51 of the Standard Resistance Value List.
- The following numbers and the letter codes is to be used to indicate the number of zeros in the 11<sup>th</sup> digit:
 

0 = 10 <sup>0</sup>	1 = 10 <sup>1</sup>	2 = 10 <sup>2</sup>	3 = 10 <sup>3</sup>	4 = 10 <sup>4</sup>
5 = 10 <sup>5</sup>	6 = 10 <sup>6</sup>	J = 10 <sup>-1</sup>	K = 10 <sup>-2</sup>	L = 10 <sup>-3</sup>
- For Cement Fixed Resistors the 8<sup>th</sup> digit will be coded with "W" or "P" to denote Wire-wound type or Power Film type respectively of the Cement Fixed Resistor product. The 9<sup>th</sup> to 11<sup>th</sup> please refer to point a) of item 4.

Example:

E-24 series	E-96 series	Cement Fixed Resistors
0120 = 12 ohm	1210 = 121 ohm	W120 = 12 ohm Wire-wound
0123 = 12K ohm	1302 = 13K ohm	W12J = 1.2 ohm Wire-wound
012J = 1.2 ohm	196J = 19.6 ohm	P273 = 27 kohm Power Film

5. The 12<sup>th</sup>, 13<sup>th</sup> & 14<sup>th</sup> digits.

- The 12<sup>th</sup> digit is to denote the Packaging Type with the following codes:
 

A = Tape / Box (Ammo pack)	C = Bulk in Cassette (Chip Product)	P = Tape / Box of PT-26 products
B = Bulk / Box	T = Tape / Reel	
- The 13<sup>th</sup> digit is normally to indicate the Packing Quantity of Tape/Box & Tape/Reel packaging types. Except for CHIP products Bulk packing, this digit should be filled with "0" for other products with "Bulk/Box" packaging requirements. The following letter codes is to be used for some packaging quantities:

A = 500pcs	B = 2,500pcs	C = 10,000pcs
D = 20,000pcs	G = 25,000pcs	H = 50,000pcs

Examples:

CHIP product	Other products
BD = B/B-20,000	A5 = T/B-5,000
TC = T/R-10,000	TB = T/R-2,500
CG = B/C-25,000	B0 = B/B (standard packing quantity available)

- For the FORMED type products, the 13<sup>th</sup> & 14<sup>th</sup> digits are used to denote the forming types of the product with the following letter codes:

MF = M-type with flattened lead wire	F0 = F-type
MK = M-type with kinked lead wire	F1 = F1 type
ML = M-type with normal lead wire	F2 = F2 type
	F3 = F3 type

- For power rating over 100 watt, the 12<sup>th</sup> to the 14<sup>th</sup> digits are to denote the actual wattage of the products:

Example: 100 = 100 watt    150 = 150 watt    225 = 225 watt

- For some items, the 14<sup>th</sup> digit alone can use to denote special features or additional information with the following codes:

P = Panasert type
1 = Avisert type 1
2 = Avisert type 2
3 = Avisert type 3
A = Cutting type CO 1/4W - A type
B = Cutting type CO 1/4W - B type

# Standard Color Code System:

Four Band Color Code (Available for CFR, MOR, KNP & 2% or 5% of MFR Products)

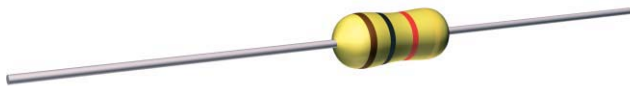

1 2 3 4

### 4<sup>th</sup> Band

Red	= ±2%
Gold	= ±5%
Silver	= ±10%

### 1<sup>st</sup> Band

Black	= 0
Brown	= 1
Red	= 2
Orange	= 3
Yellow	= 4
Green	= 5
Blue	= 6
Violet	= 7
Grey	= 8
White	= 9

### 2<sup>nd</sup> Band

Black	= 0
Brown	= 1
Red	= 2
Orange	= 3
Yellow	= 4
Green	= 5
Blue	= 6
Violet	= 7
Grey	= 8
White	= 9

### 3<sup>rd</sup> Band

Black	= Multiply by 1 ( $10^0$ )
Brown	= Multiply by 10 ( $10^1$ )
Red	= Multiply by 100 ( $10^2$ )
Orange	= Multiply by 1,000 ( $10^3$ )
Yellow	= Multiply by 10,000 ( $10^4$ )
Green	= Multiply by 100,000 ( $10^5$ )
Blue	= Multiply by 1,000,000 ( $10^6$ )
Violet	= Multiply by 10,000,000 ( $10^7$ )
Gold	= Multiply by 0.1 ( $10^{-1}$ )
Silver	= Multiply by 0.01 ( $10^{-2}$ )

Five Band Color Code (Available for MFR 1% & FRN Products)

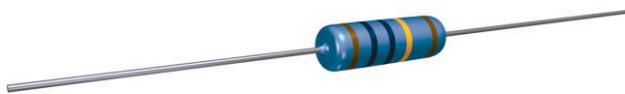

1 2 3 4 5

### 5<sup>th</sup> Band

Violet	= ±0.1%
Blue	= ±0.25%
Green	= ±0.5%
Brown	= ±1%

### 1<sup>st</sup> Band

Black	= 0
Brown	= 1
Red	= 2
Orange	= 3
Yellow	= 4
Green	= 5
Blue	= 6
Violet	= 7
Grey	= 8
White	= 9

### 2<sup>nd</sup> Band

Black	= 0
Brown	= 1
Red	= 2
Orange	= 3
Yellow	= 4
Green	= 5
Blue	= 6
Violet	= 7
Grey	= 8
White	= 9

### 3<sup>rd</sup> Band

Black	= 0
Brown	= 1
Red	= 2
Orange	= 3
Yellow	= 4
Green	= 5
Blue	= 6
Violet	= 7
Grey	= 8
White	= 9

### 4<sup>th</sup> Band

Black	= Multiply by 1 ( $10^0$ )
Brown	= Multiply by 10 ( $10^1$ )
Red	= Multiply by 100 ( $10^2$ )
Orange	= Multiply by 1,000 ( $10^3$ )
Yellow	= Multiply by 10,000 ( $10^4$ )
Green	= Multiply by 100,000 ( $10^5$ )
Blue	= Multiply by 1,000,000 ( $10^6$ )
Violet	= Multiply by 10,000,000 ( $10^7$ )
Gold	= Multiply by 0.1 ( $10^{-1}$ )
Silver	= Multiply by 0.01 ( $10^{-2}$ )