Multilayer Ceramic Capacitor



Multilayer Ceramic Capacitor

■ INTRODUCTION

MLCC(Multilayer Ceramic Capacitor) is SMD(Surface Mounted Device) type capacitor that is used in wide ranges of capacitance. MLCC is paid more attentions than other capacitors due to the better frequency characteristics, higher reliability, higher withstanding voltage and so on.

MLCC is made of many layers of ceramic and inner electrodes like sandwich. Pd was used for inner electrodes. But the price of Pd was skyrocketed and Pd was replaced by the BME(Base Metal Electrode), which reduced the total cost of MLCC.

This inner electrode is connected to outer termination for surface mounting, which is composed of three layers, Cu or Ag layer, Ni plating layer, and SnPb or Sn plating layer. Most of MLCCs become Pb free by the environmental issue at present.

MLCC is divided into two classes. Class I(C0G, etc) is the temperature compensating type. It has a small TCC(Temperature Coefficient of Capacitance) and a better frequency performance. Therefore, it is used in RF applications such as cellular phone, tuner, and so on. Class II(X7R, X5R, Y5V, etc) is the high dielectric constant type, which is used in general electronic circuit. Especially high capacitance MLCC is replacing other capacitors (Tantalum and Aluminum capacitor) due to the low ESR(Equivalent Series Resistance) value.

■ FEATURE AND APPLICATION

● Feature

- Miniature Size
- Wide Capacitance and Voltage Range
- Highly Reliable Performance
- Tape & Reel for Surface Mount Assembly
- Low ESR
- High Q at High Frequencies
- Stable Temperature Dependence of Capacitance

● Application

- High Frequency Circuit(Tuner, VCO, PAM etc)
- General Power Supply Circuit(SMPS etc)
- DC-DC Converter
- General Electronic Circuit

Multilayer Ceramic Capacitor

■ STRUCTURE

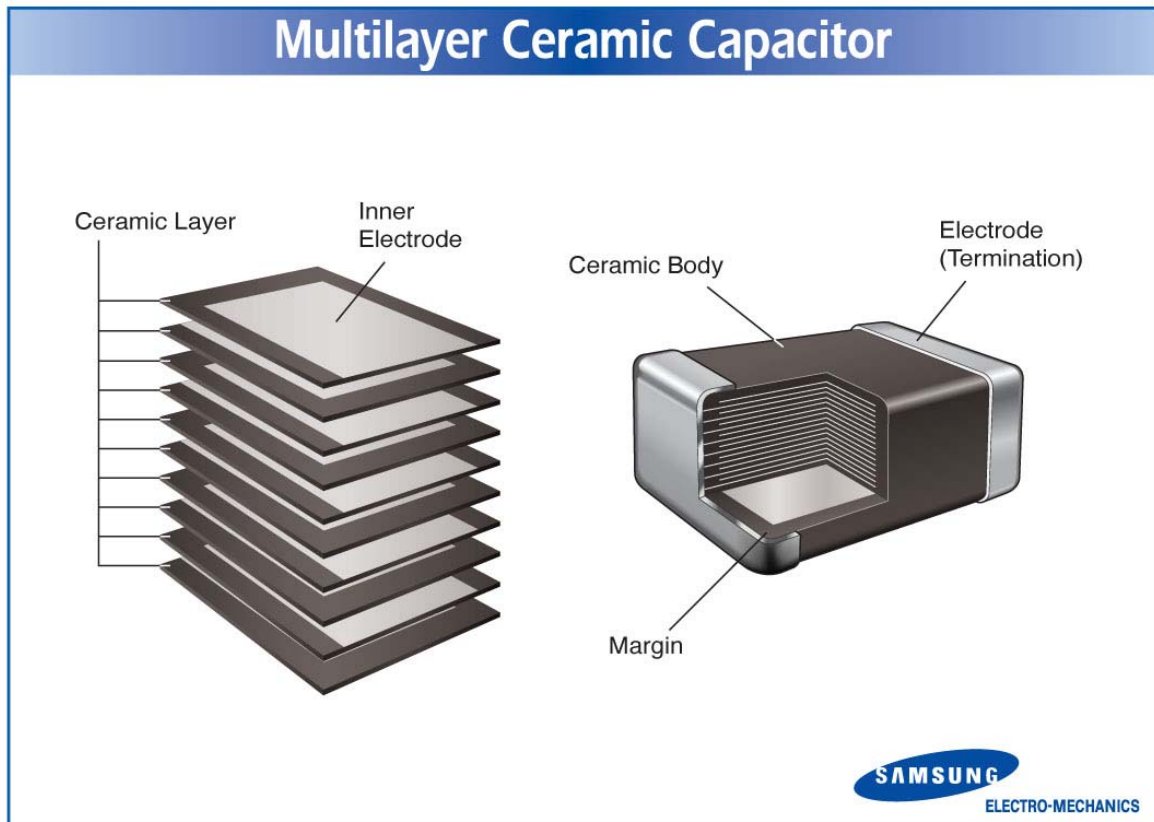

Multilayer Ceramic Capacitor

■ APPEARANCE AND DIMENSION

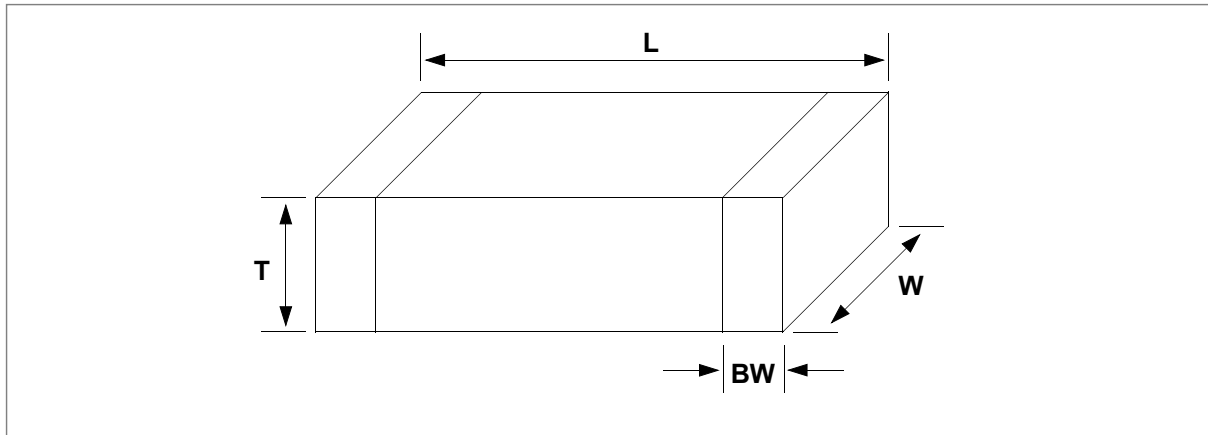

CODE	EIA CODE	DIMENSION (mm)			
		L	W	T (MAX)	BW
03	0201	0.6 ± 0.03	0.3 ± 0.03	0.3 ± 0.03	0.15 ± 0.05
05	0402	1.0 ± 0.05	0.5 ± 0.05	0.5 ± 0.05	$0.2 + 0.15 / - 0.1$
10	0603	1.6 ± 0.1	0.8 ± 0.1	0.8 ± 0.1	0.3 ± 0.2
21	0805	2.0 ± 0.1	1.25 ± 0.1	1.25 ± 0.1	$0.5 + 0.2 / - 0.3$
31	1206	3.2 ± 0.2	1.6 ± 0.2	1.6 ± 0.2	$0.5 + 0.2 / - 0.3$
32	1210	3.2 ± 0.3	2.5 ± 0.2	2.5 ± 0.2	0.6 ± 0.3
43	1812	4.5 ± 0.4	3.2 ± 0.3	3.2 ± 0.3	0.8 ± 0.3
55	2220	5.7 ± 0.4	5.0 ± 0.4	3.2 ± 0.3	1.0 ± 0.3

Multilayer Ceramic Capacitor

PREVIOUS PART NUMBERING

CL **10** **C** **101** **J** **B** **N** **C**
① **②** **③** **④** **⑤** **⑥** **⑦** **⑧**

- ① SAMSUNG Multilayer Ceramic Capacitor
- ② Type(Size)
- ③ Capacitance Temperature Characteristics
- ④ Nominal Capacitance
- ⑤ Capacitance Tolerance
- ⑥ Rated Voltage
- ⑦ Thickness Option
- ⑧ Packaging Type

③ CAPACITANCE TEMPERATURE CHARACTERISTICS

▶ CLASS I (Temperature Compensation)

Symbol	EIA Code	Temperature Coefficient(PPM/°C)	※ Temperature Characteristics	Operation Temperature Range
C	C0G(CH)	0 ± 30	CΔ	-55 ~ +125°C
P	P2H	-150 ± 60	PΔ	
R	R2H	-220 ± 60	RΔ	
S	S2H	-330 ± 60	SΔ	
T	T2H	-470 ± 60	TΔ	
U	U2J	-750 ± 120	UΔ	
L	S2L	+350 ~ -1000	SL	

※ Temperature Characteristics

Temperature Characteristics	below 2.0pF	2.2 ~ 3.9pF	above 4.0pF	above 10pF	
CΔ	C0G	C0G	C0G	C0G	
PΔ	-	P2J	P2H	P2H	
RΔ	-	R2J	R2H	R2H	☞ K : ±250 PPM/°C
SΔ	-	S2J	S2H	S2H	J : ±120 PPM/°C
TΔ	-	T2J	T2H	T2H	H : ±60 PPM/°C
UΔ	-	U2J	U2J	U2J	G : ±30 PPM/°C

▶ CLASS II (High Dielectric Constant)

Symbol	EIA Code	Capacitance Change (ΔC : %)	Operation Temperature Range
A	X5R	± 15	-55 ~ +85°C
B	X7R	± 15	-55 ~ +125°C
F	Y5V	+22 ~ -82	-30 ~ +85°C

Multilayer Ceramic Capacitor

④ NOMINAL CAPACITANCE

The nominal capacitance value is expressed in pico-Farad(pF) and identified by three-digit number, first two digits represent significant figures and last digit specifies the number of zeros to follow. For values below 1pF, the letter "R" is used as the decimal point and the last digit becomes significant.

example)

100	:	$10 \times 10^0 =$	10pF
102	:	$10 \times 10^2 =$	1000pF
020	:	$2 \times 10^0 =$	2pF
1R5	:		1.5pF

⑤ CAPACITANCE TOLERANCE

Temperature Characteristics	Symbol	Tolerance	Applicable Capacitance & Range
C0G(NPO) or T.C Series	B	$\pm 0.1\text{pF}$	0.5 ~ 3pF
	C	$\pm 0.25\text{pF}$	0.5 ~ 10pF
	D	$\pm 0.5\text{pF}$	
	F	$\pm 1\text{pF}$	6 ~ 10pF
	G	$\pm 2\%$	E-24 Series for over 10pF
	J	$\pm 5\%$	
	K	$\pm 10\%$	
A(X5R) B(X7R)	J	$\pm 5\%$	E-12 Series
	K	$\pm 10\%$	
	M	$\pm 20\%$	
F(Y5V)	Z	-20% ~ +80%	E-6 Series

※ Please consult us for special tolerances.

⑥ RATED VOLTAGE

Symbol	Rated Voltage(Vdc)	Symbol	Rated Voltage(Vdc)
Q	6.3V	D	200V
P	10V	G	500V
O	16V	I	1000V
A	25V	J	2000V
B	50V	K	3000V
C	100V		

Multilayer Ceramic Capacitor

⑦ THICKNESS OPTION

Symbol	Description of the Code
N	Standard thickness (please refer to standard thickness table on next page)
A	Thinner than standard thickness
B	Thicker than standard thickness
C	Standard Thickness High Q (Low ` D.F `)
D	Sn-100% (High-Q)
E	Sn-100% (General)

※ Please Consult us for other termination type.

⑧ PACKAGING TYPE

Symbol	Packaging	Symbol	Packaging
B	Bulk	F	Embossed Tape, 13" Reel
P	Cassette	L	Paper 13" Reel
C	Paper Tape, 7" Reel	O	Paper 10" Reel
D	Paper Tape, 13" Reel	S	Embossed Tape, 10" Reel
E	Embossed Tape, 7" Reel		

▶ STANDARD CAPACITANCE STEP

Series	Capacitance Step											
E- 3	1.0				2.2				4.7			
E- 6	1.0	1.5		2.2	3.3		4.7		6.8			
E-12	1.0	1.2	1.5	1.8	2.2	2.7	3.3	3.9	4.7	5.6	6.8	8.2
E-24	1.0	1.2	1.5	1.8	2.2	2.7	3.3	3.9	4.7	5.6	6.8	8.2
	1.1	1.3	1.6	2.0	2.4	3.0	3.6	4.3	5.1	6.2	7.5	9.1

※ Standard Capacitance is " Each step $\times 10^n$ "

Multilayer Ceramic Capacitor

■ NEW PART NUMBERING

CL	10	C	101	J	B	8	N	N	N	C
①	②	③	④	⑤	⑥	⑦	⑧	⑨	⑩	⑪

- ① SAMSUNG Multilayer Ceramic Capacitor
- ② Size(mm)
- ③ Capacitance Temperature Characteristic
- ④ Nominal Capacitance
- ⑤ Capacitance Tolerance
- ⑥ Rated Voltage
- ⑦ Thickness Option
- ⑧ Product & Plating Method
- ⑨ Samsung Control Code
- ⑩ Reserved For Future Use
- ⑪ Packaging Type

① PRODUCT ABBREVIATION

Symbol	Product Abbreviation
CL	SAMSUNG Multilayer Ceramic Capacitor

② SIZE(mm)

Symbol	Size(mm)	
	Length	Width
03	0.6	0.3
05	1.0	0.5
10	1.6	0.8
21	2.0	1.2
31	3.2	1.6
32	3.2	2.5
43	4.5	3.2
55	5.7	5.0

Multilayer Ceramic Capacitor

③ CAPACITANCE TEMPERATURE CHARACTERISTIC

Symbol	Temperature Characteristics				Temperature Range
C	Class I	COG	C△	0±30(ppm/°C)	-55 ~ +125°C
P		P2H	P△	-150±60	
R		R2H	R△	-220±60	
S		S2H	S△	-330±60	
T		T2H	T△	-470±60	
U		U2J	U△	-750±60	
L		S2L	S△	+350 ~ -1000	
A	Class II	X5R	X5R	±15%	-55 ~ +85°C
B		X7R	X7R	±15%	-55 ~ +125°C
F		Y5V	Y5V	+22 ~ -82%	-30 ~ +85°C

※ Temperature Characteristic

Temperature Characteristics	Below 2.0pF	2.2 ~ 3.9pF	Above 4.0pF	Above 10pF
C△	C0G	C0G	C0G	C0G
P△	-	P2J	P2H	P2H
R△	-	R2J	R2H	R2H
S△	-	S2J	S2H	S2H
T△	-	T2J	T2H	T2H
U△	-	U2J	U2J	U2J

J : ±120PPM/°C, H : ±60PPM/°C, G : ±30PPM/°C

④ NOMINAL CAPACITANCE

Nominal capacitance is identified by 3 digits.

The first and second digits identify the first and second significant figures of the capacitance.

The third digit identifies the multiplier. 'R' identifies a decimal point.

● Example

Symbol	Nominal Capacitance
1R5	1.5pF
103	10,000pF, 10nF, 0.01 μF
104	100,000pF, 100nF, 0.1 μF

Multilayer Ceramic Capacitor

⑤ CAPACITANCE TOLERANCE

Symbol	Tolerance	Nominal Capacitance
A	$\pm 0.05\text{pF}$	Less than 10pF (Including 10pF)
B	$\pm 0.1\text{pF}$	
C	$\pm 0.25\text{pF}$	
D	$\pm 0.5\text{pF}$	
F	$\pm 1\text{pF}$	
F	$\pm 1\%$	More than 10pF
G	$\pm 2\%$	
J	$\pm 5\%$	
K	$\pm 10\%$	
M	$\pm 20\%$	
Z	+80, -20%	

⑥ RATED VOLTAGE

Symbol	Rated Voltage	Symbol	Rated Voltage
Q	6.3V	E	250V
P	10V	G	500V
O	16V	H	630V
A	25V	I	1,000V
B	50V	J	2,000V
C	100V	K	3,000V
D	200V		

Multilayer Ceramic Capacitor

⑦ THICKNESS OPTION

Type	Symbol	Thickness(T)	Spec
0603	3	0.30	±0.03
1005	5	0.50	±0.05
1608	8	0.80	±0.10
2012	A	0.65	±0.10
	C	0.85	
	F	1.25	±0.10
3216	C	0.85	±0.15
	F	1.25	±0.15
	H	1.6	±0.20
3225	F	1.25	±0.20
	H	1.6	
	I	2.0	
	J	2.5	
4532	F	1.25	±0.20
	H	1.6	
	I	2.0	
	J	2.5	
	L	3.2	±0.30
5750	F	1.25	±0.20
	H	1.6	
	I	2.0	
	J	2.5	
	L	3.2	±0.30

Multilayer Ceramic Capacitor

⑧ PRODUCT & PLATING METHOD

Symbol	Electrode	Termination	Plating Type
A	Pd	Ag	Sn_100%
N	Ni	Cu	Sn_100%
G	Cu	Cu	Sn_100%

⑨ SAMSUNG CONTROL CODE

Symbol	Description of the code	Symbol	Description of the code
A	Array (2-element)	N	Normal
B	Array (4-element)	P	Automotive
C	High - Q	W	3 Terminal EMI Filter
L	LICC		

⑩ RESERVED FOR FUTURE USE

Symbol	Description of the code
N	Reserved for future use

⑪ PACKAGING TYPE

Symbol	Packaging Type	Symbol	Packaging Type
B	Bulk	F	Embossing 13" (10,000EA)
P	Bulk Case	L	Paper 13" (15,000EA)
C	Paper 7"	O	Paper 10"
D	Paper 13" (10,000EA)	S	Embossing 10"
E	Embossing 7"		

Multilayer Ceramic Capacitor

► CAPACITANCE vs CHIP THICKNESS STANDARD

Description		0603 (0201)	1005 (0402)	1608 (0603)	2012 Type (0805)			3216 Type (1206)			3225 Type (1210)				4532 Type (1812)				5750 Type (2220)				
Dimension (mm)	L	0.6 ±0.03	1.0 ±0.05	1.6 ±0.1	2.0±0.1			3.2±0.15		3.2 ±0.2	3.2±0.3				4.5±0.4				5.7±0.4				
	W	0.3 ±0.03	0.5 ±0.05	0.8 ±0.1	1.25±0.1			1.6±0.15		1.6 ±0.2	2.5±0.2				3.2±0.3				5.0±0.4				
	T	0.3 ±0.03	0.5~ 0.05	0.8 ±0.1	0.65 ±0.1	0.85 ±0.1	1.25 ±0.1	0.85 ±0.15	1.25 ±0.15	1.6 ±0.2	1.25 ±0.2	1.6 ±0.2	2.0 ±0.2	2.5 ±0.2	1.25 ±0.2	1.6 ±0.2	2.0 ±0.2	2.5 ±0.2	1.6 ±0.2	2.0 ±0.2	2.5 ±0.2		
CAPACITANCE (TP) (nF)	SL	50V	-	0.5~ 240	0.5~ 1000	0.5~ 1000	1100~ 1500	1600~ 2700	0.5~ 2700	3000~ 5600	6200~ 8200	-	-	-	-	-	-	-	-	-	-	-	
	C, TC (Except SL,UJ)	25V	0.5~ 47	0.5~ 220	0.5~ 1000	-	-	3300~ 8200	1500~ 3600	3900~ 6800	7500~ 10000	-	-	-	-	-	100000	-	-	-	-	-	
		50V	-	0.5~ 180	0.5~ 1000	0.5~ 560	620~ 1000	1100~ 3300	0.5~ 2200	2400~ 4700	-	560~ 10000	11000~ 22000	24000~ 47000	-	1000~ 13000	15000~ 22000	24000~ 47000	62000~ 68000	43000	93000	130000	
CAPACITANCE RANGE (nF)	A (X5R)	6.3V	10	220	2200	-	-	10000	-	-	10000	-	-	-	22000	-	-	-	47000	-	-	47000	
		10V	10	100	1000	-	-	2200	-	-	4700~ 10000	-	-	-	22000	-	-	-	-	-	-	47000	
		16V	-	47	330~ 470	-	-	1000	-	-	4700	-	-	-	6800~ 10000	-	-	-	-	-	-	-	
		25V	-	-	-	-	-	-	-	-	-	-	-	-	-	-	-	-	-	-	-	-	
		50V	-	6.8~ 10	-	-	-	-	-	-	-	-	-	-	-	-	-	-	-	-	-	-	
	B (X7R)	6.3V	0.1~ 10	47~ 100	470~ 1000	-	-	1000	-	-	6800~ 10000	-	-	-	22000	-	-	-	-	-	-	-	
		10V	0.1~ 10	33~ 100	220~ 470	220~ 270	330~ 470	560~ 1000	-	1000~ 3300	4700	1500~ 2200	3300	3900~ 4700	-	-	-	-	22000	-	-	-	
		16V	0.1~ 1	10~ 33	100~ 220	68~ 200	220~ 330	390~ 1000	330~ 680	1000~ 1500	2200~ 3300	1500~ 2200	3300	3900~ 4700	-	-	-	2200	-	-	-	-	
		25V	-	4.7~ 10	47~ 100	39~ 68	82~ 100	150~ 470	100~ 330	470~ 620	680~ 1000	680~ 1500	1800	2200	-	-	-	1000	-	-	-	-	10000
		50V	-	0.22~ 4.7	0.22~ 100	0.22~ 39	47~ 100	220	1~ 150	220	390~ 1000	2.2~ 680	820~ 1000	-	-	10~ 1000	-	-	-	-	-	-	3300~ 4700
	F (Y5V)	6.3V	10~ 100	-	2200	-	-	10000	-	-	-	-	-	47000	-	-	-	-	-	-	-	-	
		10V	-	220~ 330	100~ 1000	-	-	4700	-	4700	10000~ 22000	-	-	-	22000	-	-	-	-	-	-	100000	
		16V	-	10~ 220	100~ 1000	10~ 680	820~ 1000	1200~ 2200	1000~ 2200	2700~ 4700	10000	3300~ 6800	10000	15000	-	-	-	22000	-	-	-	-	
		25V	-	10~ 33	22~ 330	10~ 220	270~ 470	560~ 1000	470~ 1000	1200~ 2200	2700~ 3300	1000~ 3300	4700~ 10000	-	-	-	-	-	10000	-	-	-	
		50V	-	2.2~ 10	2.2~ 100	2.2~ 68	82~ 150	180~ 1000	10~ 470	560~ 1000	-	100~ 1000	-	-	-	-	-	-	10000	-	-	-	

Multilayer Ceramic Capacitor

PACKAGING

CARDBOARD PAPER TAPE

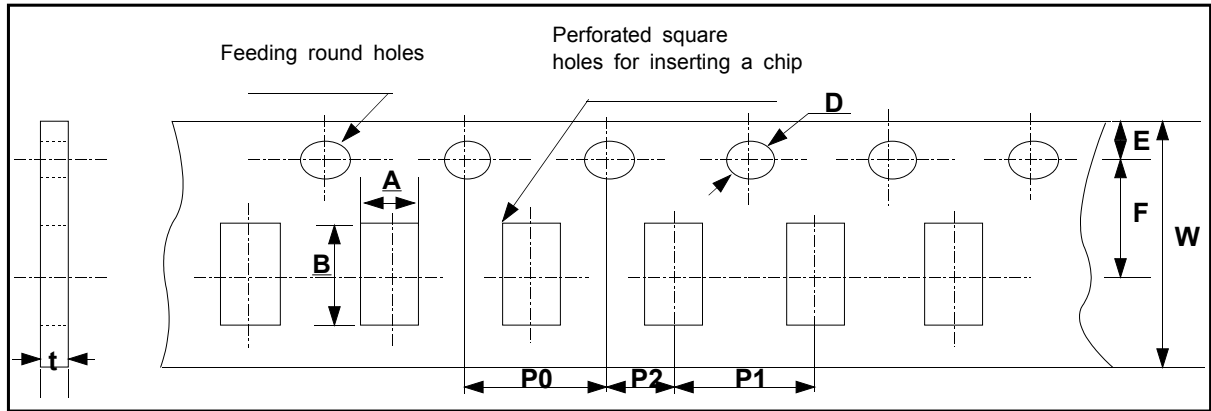

unit : mm

Symbol Type		W	F	E	P1	P2	P0	D	t	A	B
Dimension	03				2.0 ±0.05				0.37 ±0.03	0.38 ±0.03	0.68 ±0.03
	05								0.6 ±0.05	0.65 +0.05/-0.1	1.15 +0.05/-0.1
	10	8.0 ±0.3	3.5 ±0.05	1.75 ±0.1		2.0 ±0.05	4.0 ±0.1	Φ1.5 +0.1/-0		1.1 ±0.2	1.9 ±0.2
	21				4.0 ±0.1				1.1 MAX	1.6 ±0.2	2.4 ±0.2
	31									2.0 ±0.2	3.6 ±0.2

EMBOSSED PLASTIC TAPE

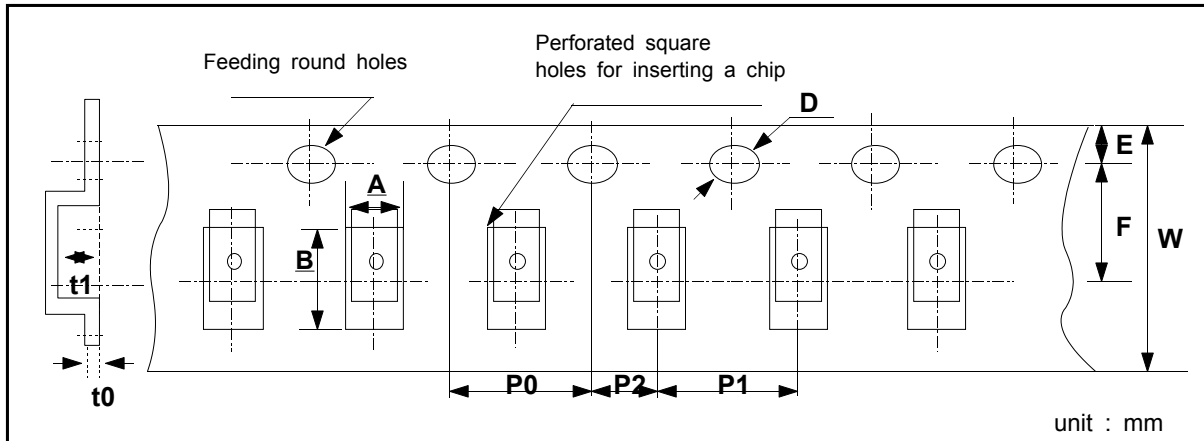

unit : mm

Symbol Type		W	F	E	P1	P2	P0	D	t0	t1	A	B
Dimension	21										1.45 ±0.2	2.3 ±0.2
	31				4.0 ±0.1	2.0 ±0.05	4.0 ±0.1	Φ1.5 +0.1/-0	0.6 max	2.5 max	2.0 ±0.2	3.6 ±0.2
	32	8.0 ±0.3	3.5 ±0.05	1.75 ±0.1							2.9 ±0.2	3.6 ±0.2
	43										3.6 ±0.2	4.9 ±0.2
	55										5.4 ±0.2	6.0 ±0.2

Multilayer Ceramic Capacitor

● TAPING SIZE

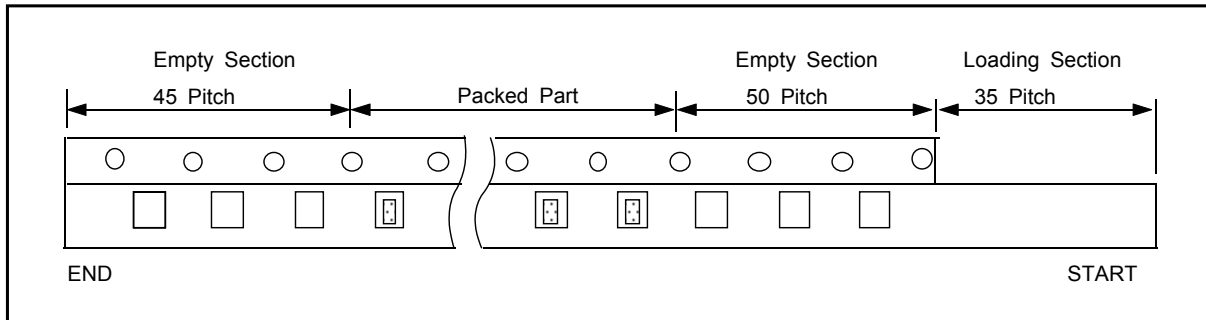

unit : pcs

Symbol	Cardboard Paper Tape	Embossed Plastic Tape
7" Reel	4000	2000
13" Reel	15000	-

● REEL DIMENSION

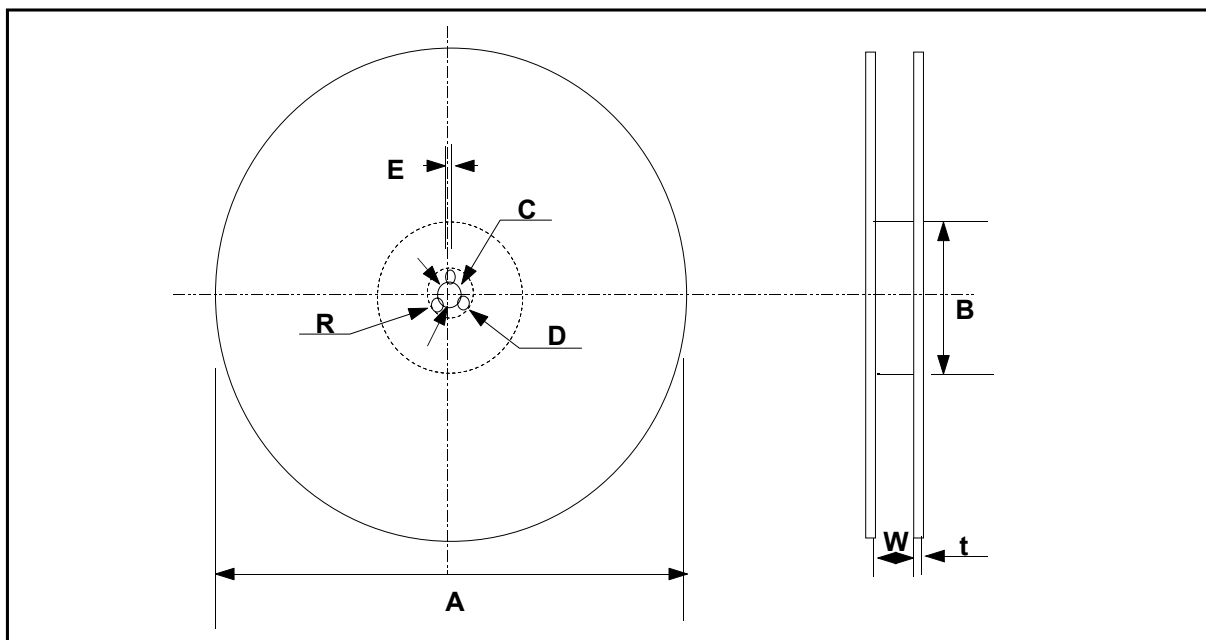

unit : mm

Symbol	A	B	C	D	E	W	t	R
7" Reel	$\phi 178 \pm 2.0$	min. $\phi 50$	$\phi 13 \pm 0.5$	21 ± 0.8	2.0 ± 0.5	10 ± 1.5	0.8 ± 0.2	1.0
13" Reel	$\phi 330 \pm 2.0$	min. $\phi 70$						

Multilayer Ceramic Capacitor

● BULK CASE PACKAGING

- Bulk case packaging can reduce the stock space and transportation costs.
- The bulk feeding system can increase the productivity.
- It can eliminate the components loss.

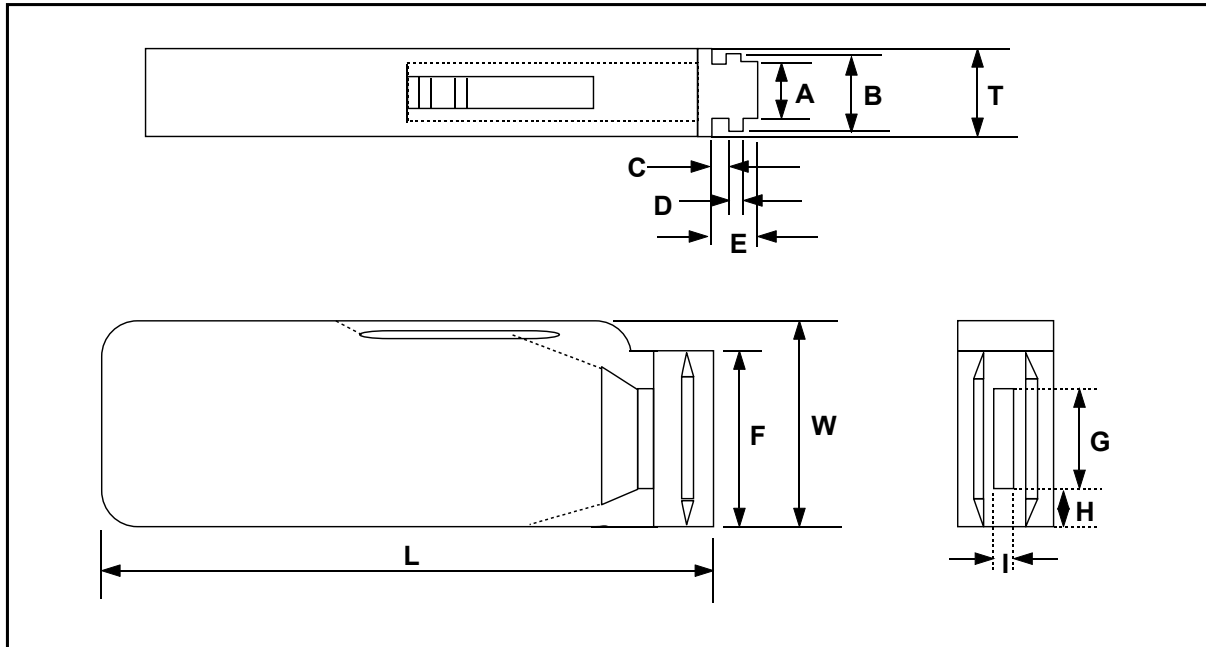

Symbol	A	B	T	C	D	E
Dimension	6.8 ± 0.1	8.8 ± 0.1	12 ± 0.1	$1.5 + 0.1 / - 0$	$2 + 0 / - 0.1$	4.7 ± 0.1

Symbol	F	W	G	H	L	I
Dimension	$31.5 + 0.2 / - 0$	$36 + 0 / - 0.2$	19 ± 0.35	7 ± 0.35	110 ± 0.7	5 ± 0.35

● QUANTITY

Size	05(0402)	10(0603)	21(0805)	
			$T \leq 0.85\text{mm}$	$T \geq 1.0\text{mm}$
Quantity	50,000	10,000~15,000*	10,000	5,000

* Option

Multilayer Ceramic Capacitor

■ CHARACTERISTIC MAP

● CLASS I

Temperature Characteristics	Size	Voltage	Capacitance Range (pF)												
			0.5	10	100	1000	10000	100000	1000000	10000000	100000000				
SL,UJ	05 (0402)	50V	████████████████████			240									
	10 (0603)	50V	██				1000								
	21 (0805)	50V	██					2700							
	31 (1206)	50V	██						8200						
C(COG) & TC Series	03 (0201)	25V	████████████████		47										
	05 (0402)	25V	████████████████████			220									
		50V	████████████████████			180									
	10 (0603)	25V	██				1000								
		50V	██				1000								
	21 (0805)	25V				3300	████████████████	8200							
		50V	██				3300								
	31 (1206)	25V				1500	████████████████	10000							
		50V	██				4700								
	32 (1210)	50V			560	██	47000								
		100V				4700	████████████████	18000							
	43 (1812)	25V								100000					
		50V				1000	██	68000							
55 (2220)	50V						43000	████████████████	130000						

Multilayer Ceramic Capacitor

● CLASS II , A(X5R)

Temperature Characteristics	Size	Voltage	Capacitance Range (pF)							
			10	100	1000	10000	100000	1000000	10000000	100000000
A(X5R)	0603 (0201)	6.3V				■ 10000				
		10V				■ 10000				
	1005 (0402)	6.3V						■ 220000		
		10V						■ 100000		
		16V				■ 47000				
		50V			6800 ■ 10000					
	1608 (0603)	6.3V							■ 2200000	
		10V							■ 1000000	
		16V					330000 ■ 470000			
	2012 (0805)	6.3V								■ 10000000
		10V							■ 2200000	
		16V							■ 1000000	
	3216 (1206)	6.3V								■ 10000000
		10V						4700000 ■ 10000000		
		16V							■ 4700000	
	3225 (1210)	6.3V								■ 22000000
		10V								■ 22000000
		16V						6800000 ■ 10000000		
	4532 (1812)	6.3V								■ 47000000
	5750 (2220)	6.3V								
10V										■ 47000000

Multilayer Ceramic Capacitor

● CLASS II , B(X7R)

Temperature Characteristics	Size	Voltage	Capacitance Range (pF)										
			10	100	1000	10000	100000	1000000	10000000	100000000			
B(X7R)	03 (0201)	6.3V		100	██████████		10000						
		10V		100	██████████		10000						
		16V		100	██████████		1000						
	05 (0402)	6.3V					47000	██████████		100000			
		10V					33000	██████████		100000			
		16V					10000	██████████		33000			
		25V					4700	██████████		10000			
		50V			220	██████████		4700					
	10 (0603)	6.3V							470000	██████████		1000000	
		10V							220000	██████████		470000	
		16V							100000	██████████		220000	
		25V							47000	██████████		100000	
		50V			220	██████████						100000	
	21 (0805)	6.3V									██████████	1000000	
		10V							220000	██████████		1000000	
		16V							68000	██████████		1000000	
		25V							39000	██████████		470000	
		50V			220	██████████						220000	
	31 (1206)	6.3V								6800000	██████████		10000000
		10V							1000000	██████████		4700000	
		16V							330000	██████████		3300000	
		25V							100000	██████████		1000000	
		50V			1000	██████████						1000000	

Multilayer Ceramic Capacitor

● CLASS II , B(X7R)

Temperature Characteristics	Size	Voltage	Capacitance Range (pF)									
			10	100	1000	10000	100000	1000000	10000000	100000000		
B(X7R)	32 (1210)	6.3V									■ 22000000	
		10V							1500000	■	4700000	
		16V							1500000	■	4700000	
		25V							680000	■	2200000	
		50V				2200	■	1000000				
	43 (1812)	10V										■ 22000000
		16V								■	2200000	
		25V								■	1000000	
		50V				10000	■	1000000				
	55 (2220)	25V										■ 10000000
		50V								3300000	■	4700000

Multilayer Ceramic Capacitor

● CLASS II , F(Y5V)

Temperature Characteristics	Size	Voltage	Capacitance Range (pF)											
			10	100	1000	10000	100000	1000000	10000000					
F(Y5V)	03 (0201)	6.3V				10000	██████████	100000						
	05 (0402)	10 V						220000	██████████	330000				
		16 V					10000	██████████	220000					
		25 V					10000	██████████	33000					
		50 V				2200	██████████	10000						
		6.3V									██████████	2200000		
	10 (0603)	10 V						100000	██████████	1000000				
		16 V						100000	██████████	1000000				
		25 V						22000	██████████	330000				
		50 V				2200	██████████	100000						
		6.3V										██████████	10000000	
	21 (0805)	10 V									██████████	4700000		
		16 V					10000	██████████	2200000					
		25 V					10000	██████████	1000000					
		50 V				2200	██████████	1000000						
		10 V									4700000	██████████	22000000	
	31 (1206)	16 V							1000000	██████████	10000000			
		25 V							470000	██████████	3300000			
		50 V					10000	██████████	1000000					
		6.3V										██████████	47000000	
	32 (1210)	10 V										██████████	22000000	
		16 V								3300000	██████████	15000000		
		25 V								1000000	██████████	10000000		
		50 V						100000	██████████	1000000				
		16V											██████████	22000000
	43 (1812)	25 V											██████████	10000000
		50 V											██████████	10000000
		10 V											██████████	100000000

Multilayer Ceramic Capacitor

RELIABILITY TEST DATA

NO	ITEM	PERFORMANCE	TEST CONDITION																
1	APPEARANCE	NO ABNORMAL EXTERIOR APPEARANCE	THROUGH MICROSCOPE(×10)																
2	INSULATION RESISTANCE	10,000MΩ OR 500MΩ·μF PRODUCT WHICHEVER IS SMALLER (RATED VOLTAGE IS BELOW 16V : 10,000MΩ OR 100MΩ·μF)	RATED VOLTAGE SHALL BE APPLIED. MEASUREMENT TIME IS 60 ~ 120 RATED VOLTAGE TIME 60 SEC.																
3	WITHSTANDING VOLTAGE	NO DIELECTRIC BREAKDOWN OR MECHANICAL BREAKDOWN	CLASS I : 300% OF THE RATED VOLTAGE FOR 1~5 SEC, CLASS II : 250% OF THE RATED VOLTAGE FOR 1~5 SEC IS APPLIED WITH LESS THAN 50mA CURRENT																
4	CAPACITANCE	CLASS I WITHIN THE SPECIFIED TOLERANCE	CAPACITANCE	FREQUENCY	VOLTAGE														
			1,000pF AND BELOW	1kHz±10%	0.5 ~ 5 Vrms														
		MORE THAN 1,000pF	1kHz±10%																
		CLASS II WITHIN THE SPECIFIED TOLERANCE	CAPACITANCE	FREQUENCY	VOLTAGE														
10μF AND BELOW	1kHz±10%		1.0±0.2Vrms																
		MORE THAN 10μF	120Hz±20%	0.5±0.1Vrms															
5	Q	CLASS I OVER 30pF : Q ≥1,000 LESS THAN 30pF: Q ≥400 +20C (C : CAPACITANCE)	CAPACITANCE	FREQUENCY	VOLTAGE														
			1,000pF AND BELOW	1kHz±10%	0.5 ~ 5 Vrms														
			MORE THAN 1,000pF	1kHz±10%															
6	Tanδ	CLASS II	1. CHAR : B																
			<table border="1"> <thead> <tr> <th>RATED VOLTAGE</th> <th>DF SPEC</th> </tr> </thead> <tbody> <tr> <td>6.3V</td> <td>0.05 max</td> </tr> <tr> <td>10V</td> <td>0.05 max</td> </tr> <tr> <td>16V</td> <td>0.035 max</td> </tr> <tr> <td>25V</td> <td>0.025 max</td> </tr> <tr> <td>50V 이상</td> <td>0.025 max</td> </tr> </tbody> </table>		RATED VOLTAGE	DF SPEC	6.3V	0.05 max	10V	0.05 max	16V	0.035 max	25V	0.025 max	50V 이상	0.025 max	CAPACITANCE	FREQUENCY	VOLTAGE
			RATED VOLTAGE	DF SPEC															
			6.3V	0.05 max															
			10V	0.05 max															
			16V	0.035 max															
			25V	0.025 max															
			50V 이상	0.025 max															
					10μF AND BELOW	1kHz±10%	1.0±0.2Vrms												
					MORE THAN 10μF	120Hz±20%	0.5±0.1Vrms												
2. CHAR : F																			
			6.3V	10V	16V	25V	50V												
		1005	-	0.125max	0.09max (C < 220nF) 0.125max (C ≥ 220nF)	0.05max	0.05max												
		1608	0.16max	0.125max	0.09max	0.05max(C ≤ 100nF) 0.07max(C > 100nF)	0.05max												
		2012	0.16max	0.125max	0.09max	0.07max	0.05max												
		3216	0.16max	0.125max	0.09max	0.07max	0.05max												
		3225	0.16max	0.125max	0.09max	0.07max(C ≤ 6.8μF) 0.09max(C > 6.8μF)	0.05max												
		4532	0.16max	0.16max	0.09max	-	-												
		5750		0.125max	-	-	-												

Multilayer Ceramic Capacitor

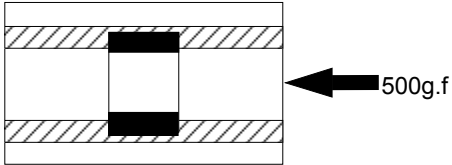
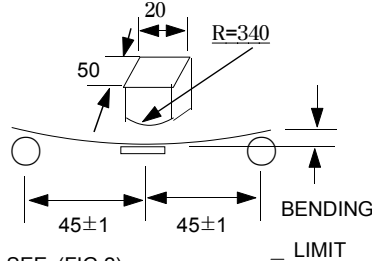
NO	ITEM		PERFORMANCE		TEST CONDITION				
7	CAPACITANCE TEMPERATURE COEFFICIENT	CLASS I	CHARACTERISTIC	TEMP. COEFFICIENT (PPM/°C)	THESE SYMMETRICAL TOLERANCE APPLY TO 2 POINT MEASUREMENT OF TEMPERATURE COEFFICIENT: ONE AT 25°C AND AT 85°C				
			COG	0 ± 30					
			PH	-150 ± 60					
			RH	-220 ± 60					
			SH	-330 ± 60					
			TH	-470 ± 60					
			UL	-750 ± 120					
			SL	+350 ~ -1000					
8	TEMPERATURE CHARACTERISTIC S	CLASS II	CAPACITANCE CHANGE		<p>The change of capacitance should be got from the capacitance at 25°C.</p> <p>After capacitance measured from Min. Temp. to Max. Temp., it should be calculated from the formula below.</p> $\frac{C2 - C1}{C1} \times 100 \%$ <p>C1 : CAPACITANCE AT STANDARD TEMPERATURE(25°C) C2 : CAPACITANCE AT EACH TEMPERATURE</p>				
			CHAR.	CAP. CHANGE(%)					
			A,B	±15%					
			F	+22% ~ -82%					
9	ADHESIVE STRENGTH OF TERMINATION		NO INDICATION OF PEELING SHALL OCCUR ON THE TERMINAL ELECTRODE.		<p>A 500g.f PRESSURE SHALL BE APPLIED FOR 10±1 SECOND.</p>  <p>SEE (FIG.1)</p>				
10	BENDING STRENGTH	APPEARANCE	NO MECHANICAL DAMAGE SHALL OCCUR.		<p>BENDING SHALL BE APPLIED TO THE LIMIT(1mm) WITH 0.3mm/SEC. KEEP THE TEST BOARD AT THE LIMIT POINT IN 5 SEC., THEN MEASURE CAPACITANCE.</p> <table border="1"> <thead> <tr> <th>CHARACTER</th> <th>LIMIT</th> </tr> </thead> <tbody> <tr> <td>C, A, B, F</td> <td>1mm</td> </tr> </tbody> </table>  <p>SEE (FIG.2)</p>	CHARACTER	LIMIT	C, A, B, F	1mm
		CHARACTER	LIMIT						
		C, A, B, F	1mm						
		CAPACITANCE	CHARACTER	CHANGE OF CAPACITANCE					
CLASS I	WITHIN ±5% OR ± 0.5 pF WHICHEVER IS LARGER								
		A,B	WITHIN ±12.5%						
		CLASS II	F	WITHIN ±30%					

Multilayer Ceramic Capacitor

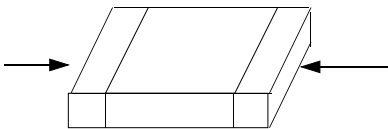
NO	ITEM	PERFORMANCE	TEST CONDITION																															
11	SOLDERABILITY	<p>MORE THAN 75% OF THE TERMINAL SURFACE IS TO BE SOLDERED NEWLY, SO METAL PART DOES NOT COME OUT OR DISSOLVE</p>  <p>IN PB--FREE PART, MORE THAN 95% OF THE TERMINAL SURFACE IS TO BE SOLDERED NEWLY</p>	<p>SOLDER TEMPERATURE : 230±5℃ DIP TIME : 3±1 Sec SOLDER : H63A FLUX : RMA TYPE *PB-FREE SOLDER TEMPERATURE : 260±5℃ SOLDER : Sn96.5-3Ag-0.5Cu Flux : RMA TYPE DIP TIME : 3±0.1Sec * PRE-HEATING : AT 80~120℃ FOR 10~30SEC.</p>																															
12	RESISTANCE TO SOLDERING HEAT	<table border="1"> <tr> <td>APPEARANCE</td> <td colspan="2">NO MECHANICAL DAMAGE SHALL OCCUR</td> </tr> <tr> <td rowspan="3">CAPACITANCE</td> <td>CHARACTERISTIC</td> <td>CAP. CHANGE</td> </tr> <tr> <td>CLASS I</td> <td>WITHIN ±2.5% OR ±0.25pF WHICHEVER IS LARGER</td> </tr> <tr> <td>CLASS II</td> <td>A,B WITHIN ±7.5% F WITHIN ±20%</td> </tr> <tr> <td>Q</td> <td colspan="2">30pF AND OVER : Q ≥ 1000 LESS THAN 30pF : Q ≥ 400+20×C</td> </tr> <tr> <td>Tanδ</td> <td colspan="2">TO SATISFY THE SPECIFIED INITIAL VALUE</td> </tr> <tr> <td>INSULATION RESISTANCE</td> <td colspan="2">TO SATISFY THE SPECIFIED INITIAL VALUE</td> </tr> <tr> <td>WITHSTANDING VOLTAGE</td> <td colspan="2">TO SATISFY THE SPECIFIED INITIAL VALUE</td> </tr> </table>	APPEARANCE	NO MECHANICAL DAMAGE SHALL OCCUR		CAPACITANCE	CHARACTERISTIC	CAP. CHANGE	CLASS I	WITHIN ±2.5% OR ±0.25pF WHICHEVER IS LARGER	CLASS II	A,B WITHIN ±7.5% F WITHIN ±20%	Q	30pF AND OVER : Q ≥ 1000 LESS THAN 30pF : Q ≥ 400+20×C		Tanδ	TO SATISFY THE SPECIFIED INITIAL VALUE		INSULATION RESISTANCE	TO SATISFY THE SPECIFIED INITIAL VALUE		WITHSTANDING VOLTAGE	TO SATISFY THE SPECIFIED INITIAL VALUE		<p>DIP : SOLDER TEMPERATURE OF 270±5℃ DIP TIME : 10±1 SEC. EACH TERMINATION SHALL BE FULLY IMMERSSED AND PREHEATED AS FOLLOWING:</p> <table border="1"> <thead> <tr> <th>STEP</th> <th>TEMP.(℃)</th> <th>TIME (SEC.)</th> </tr> </thead> <tbody> <tr> <td>1</td> <td>80~100</td> <td>60</td> </tr> <tr> <td>2</td> <td>150~180</td> <td>60</td> </tr> </tbody> </table> <p>MEASURE AT ROOM TEMP. AFTER COOLING FOR CLASS I : 24 ± 2 HOURS CLASS II : 48 ± 4 HOURS</p>	STEP	TEMP.(℃)	TIME (SEC.)	1	80~100	60	2	150~180	60
APPEARANCE	NO MECHANICAL DAMAGE SHALL OCCUR																																	
CAPACITANCE	CHARACTERISTIC	CAP. CHANGE																																
	CLASS I	WITHIN ±2.5% OR ±0.25pF WHICHEVER IS LARGER																																
	CLASS II	A,B WITHIN ±7.5% F WITHIN ±20%																																
Q	30pF AND OVER : Q ≥ 1000 LESS THAN 30pF : Q ≥ 400+20×C																																	
Tanδ	TO SATISFY THE SPECIFIED INITIAL VALUE																																	
INSULATION RESISTANCE	TO SATISFY THE SPECIFIED INITIAL VALUE																																	
WITHSTANDING VOLTAGE	TO SATISFY THE SPECIFIED INITIAL VALUE																																	
STEP	TEMP.(℃)	TIME (SEC.)																																
1	80~100	60																																
2	150~180	60																																
13	VIBRATION TEST	<table border="1"> <tr> <td>APPEARANCE</td> <td colspan="2">NO MECHANICAL DAMAGE SHALL OCCUR.</td> </tr> <tr> <td rowspan="3">CAPACITANCE</td> <td>CHARACTERISTIC</td> <td>CAP. CHANGE</td> </tr> <tr> <td>CLASS I</td> <td>WITHIN ±2.5% OR ±0.25pF WHICHEVER IS LARGER</td> </tr> <tr> <td>CLASS II</td> <td>A,B WITHIN ±5% F WITHIN ±20%</td> </tr> <tr> <td>Q</td> <td colspan="2">30pF AND OVER : Q ≥ 1000 LESS THAN 30pF : Q ≥ 400+20×C</td> </tr> <tr> <td>Tanδ</td> <td colspan="2">TO SATISFY THE SPECIFIED INITIAL VALUE</td> </tr> <tr> <td>INSULATION RESISTANCE</td> <td colspan="2">TO SATISFY THE SPECIFIED INITIAL VALUE</td> </tr> </table>	APPEARANCE	NO MECHANICAL DAMAGE SHALL OCCUR.		CAPACITANCE	CHARACTERISTIC	CAP. CHANGE	CLASS I	WITHIN ±2.5% OR ±0.25pF WHICHEVER IS LARGER	CLASS II	A,B WITHIN ±5% F WITHIN ±20%	Q	30pF AND OVER : Q ≥ 1000 LESS THAN 30pF : Q ≥ 400+20×C		Tanδ	TO SATISFY THE SPECIFIED INITIAL VALUE		INSULATION RESISTANCE	TO SATISFY THE SPECIFIED INITIAL VALUE		<p>BENDING SHALL BE APPLIED TO THE LIMIT(1mm) WITH 0.3mm/SEC. KEEP THE TEST BOARD AT THE LIMIT POINT IN 5 SEC., THEN MEASURE CAPACITANCE.</p> <table border="1"> <thead> <tr> <th>CHAR.</th> <th>FREQUENCY RANGE</th> </tr> </thead> <tbody> <tr> <td>A,B,C,F</td> <td>10Hz → 55Hz → 10Hz</td> </tr> </tbody> </table> <table border="1"> <thead> <tr> <th>CHAR.</th> <th>TRAVERSED TIME</th> </tr> </thead> <tbody> <tr> <td>A,B,C,F</td> <td>1 min</td> </tr> </tbody> </table> <p>THE ENTIRE FREQUENCY RANGE, FROM 10 TO 55Hz AND RETURN TO 10Hz, SHALL BE TRAVERSED IN 1 MINUTE.</p> <p>THIS CYCLE SHALL BE PERFORMED 2 HOURS IN EACH THERE MUTUALLY PERPENDICULAR DIRECTION, FOR TOTAL PERIOD OF 6 HOURS.</p>	CHAR.	FREQUENCY RANGE	A,B,C,F	10Hz → 55Hz → 10Hz	CHAR.	TRAVERSED TIME	A,B,C,F	1 min				
APPEARANCE	NO MECHANICAL DAMAGE SHALL OCCUR.																																	
CAPACITANCE	CHARACTERISTIC	CAP. CHANGE																																
	CLASS I	WITHIN ±2.5% OR ±0.25pF WHICHEVER IS LARGER																																
	CLASS II	A,B WITHIN ±5% F WITHIN ±20%																																
Q	30pF AND OVER : Q ≥ 1000 LESS THAN 30pF : Q ≥ 400+20×C																																	
Tanδ	TO SATISFY THE SPECIFIED INITIAL VALUE																																	
INSULATION RESISTANCE	TO SATISFY THE SPECIFIED INITIAL VALUE																																	
CHAR.	FREQUENCY RANGE																																	
A,B,C,F	10Hz → 55Hz → 10Hz																																	
CHAR.	TRAVERSED TIME																																	
A,B,C,F	1 min																																	

* THE INITIAL VALUE OF HIGH DIELECTRIC CONSTANT SERIES SHALL BE MEASURED AFTER THE HEAT TREATMENT OF 150 +0/-10℃, 1hr AND SITTING OF 48±4hr AT ROOM TEMPERATURE & ROOM HUMIDITY.

Multilayer Ceramic Capacitor

NO	ITEM	PERFORMANCE	TEST CONDITION																
14	HUMIDITY (STEADY STATE)	APPEARANCE	NO MECHANICAL DAMAGE SHALL OCCUR																
		CAPACITANCE	CHARACTERISTIC	CAPACITANCE CHANGE															
			CLASS I	WITHIN $\pm 5\%$ OR $\pm 0.5\text{pF}$ WHICHEVER IS LARGER															
			CLASS II	WITHIN $\pm 30\%$															
		Q	30pF AND OVER : $Q \geq 350$ 10 ~30pF : $Q \geq 275 + 2.5 \times C$ LESS THAN 10pF : $Q \geq 200 + 10 \times C$																
Tan δ	<table border="1"> <thead> <tr> <th>CHAR.</th> <th>25V AND OVER</th> <th>16V</th> <th>10V</th> <th>6.3V</th> <th>4V</th> </tr> </thead> <tbody> <tr> <td>A,B</td> <td>0.05</td> <td>0.05 MAX</td> <td>0.05 MAX</td> <td>0.075 MAX</td> <td>0.1 MAX</td> </tr> <tr> <td>F</td> <td>0.075 MAX</td> <td>0.1MAX (C < 1.0μF) 0.125 MAX (C $\geq 1.0\mu\text{F}$)</td> <td>0.15 MAX</td> <td>0.195 MAX</td> <td>0.25 MAX</td> </tr> </tbody> </table>	CHAR.	25V AND OVER	16V	10V	6.3V	4V	A,B	0.05	0.05 MAX	0.05 MAX	0.075 MAX	0.1 MAX	F	0.075 MAX	0.1MAX (C < 1.0 μF) 0.125 MAX (C $\geq 1.0\mu\text{F}$)	0.15 MAX	0.195 MAX	0.25 MAX
CHAR.	25V AND OVER	16V	10V	6.3V	4V														
A,B	0.05	0.05 MAX	0.05 MAX	0.075 MAX	0.1 MAX														
F	0.075 MAX	0.1MAX (C < 1.0 μF) 0.125 MAX (C $\geq 1.0\mu\text{F}$)	0.15 MAX	0.195 MAX	0.25 MAX														
INSULATION RESISTANCE	MINIMUM INSULATION RESISTANCE: 1,000 M Ω OR 50M $\Omega \cdot \mu\text{F}$ PRODUCT WHICHEVER IS SMALLER																		
15	MOISTURE RESISTANCE	APPEARANCE	NO MECHANICAL DAMAGE SHALL OCCUR																
		CAPACITANCE	CHARACTERISTIC	CAPACITANCE CHANGE															
			CLASS I	WITHIN $\pm 7.5\%$ OR $\pm 0.75\text{pF}$ WHICHEVER IS LARGER															
			CLASS II	WITHIN $\pm 12.5\%$ WITHIN $\pm 30\%$ WITHIN +30~-40% 1005 C > 0.47 μF 1608 C > 1.0 μF 2012 C > 4.7 μF 3216 C > 10.0 μF 3225 C > 22.0 μF 4532 C > 47.0 μF															
		Q	30pF AND OVER : $Q \geq 200$ 30pF AND BELOW : $Q \geq 100 + 10/3 \times C$																
Tan δ	<table border="1"> <thead> <tr> <th>CHAR.</th> <th>25V AND OVER</th> <th>16V</th> <th>10V</th> <th>6.3V</th> <th>4V</th> </tr> </thead> <tbody> <tr> <td>A,B</td> <td>0.05 MAX</td> <td>0.05 MAX</td> <td>0.05 MAX</td> <td>0.075 MAX</td> <td>0.1 MAX</td> </tr> <tr> <td>F</td> <td>0.075 MAX</td> <td>0.1MAX (C < 1.0μF) 0.125MAX (C $\geq 1.0\mu\text{F}$)</td> <td>0.15 MAX</td> <td>0.195 MAX</td> <td>0.25 MAX</td> </tr> </tbody> </table>	CHAR.	25V AND OVER	16V	10V	6.3V	4V	A,B	0.05 MAX	0.05 MAX	0.05 MAX	0.075 MAX	0.1 MAX	F	0.075 MAX	0.1MAX (C < 1.0 μF) 0.125MAX (C $\geq 1.0\mu\text{F}$)	0.15 MAX	0.195 MAX	0.25 MAX
CHAR.	25V AND OVER	16V	10V	6.3V	4V														
A,B	0.05 MAX	0.05 MAX	0.05 MAX	0.075 MAX	0.1 MAX														
F	0.075 MAX	0.1MAX (C < 1.0 μF) 0.125MAX (C $\geq 1.0\mu\text{F}$)	0.15 MAX	0.195 MAX	0.25 MAX														
INSULATION RESISTANCE	MINIMUM INSULATION RESISTANCE: 500 M Ω OR 25M $\Omega \cdot \mu\text{F}$ PRODUCT, WHICHEVER IS SMALLER.																		
			<p>APPLIED VOLTAGE : RATED VOLTAGE</p> <p>TEMPERATURE : 40 ± 2 °C RELATIVE HUMIDITY: 90~95%RH TEST TIME : 500 +12/-0 Hr. CURRENT APPLIED : 50mA MAX.</p> <p><INITIAL MEASUREMENT> CLASS II SHOULD BE MEASURED INITIAL VALUE AFTER BE HEAT-TREATED FOR 1 HR IN 150°C+0/-10°C AND BE LEFT FOR 48±4HR AT ROOM TEMPERATURE.</p> <p><LATTER MEASUREMENT> CLASS I SHOULD BE MEASURED AFTER LEFT FOR 24±2 HRS IN ROOM TEMPERATURE AND HUMIDITY. CLASS II SHOULD BE MEASURED LATTER VALUE AFTER BE HEAT-TREATED FOR 1 HR IN 150°C+0/-10 °C AND BE LEFT FOR 48±4HR AT ROOM TEMPERATURE.</p> <table border="1"> <thead> <tr> <th>6.3V Tanδ</th> <th>0.125 MAX *Condition</th> </tr> </thead> <tbody> <tr> <td rowspan="6">CLASS II (A,B)</td> <td>1005 C $\geq 0.22\mu\text{F}$</td> </tr> <tr> <td>1608 C $\geq 2.2\mu\text{F}$</td> </tr> <tr> <td>2012 C $\geq 4.7\mu\text{F}$</td> </tr> <tr> <td>3216 C $\geq 10.0\mu\text{F}$</td> </tr> <tr> <td>3225 C $\geq 22.0\mu\text{F}$</td> </tr> <tr> <td>4532 C $\geq 47.0\mu\text{F}$</td> </tr> <tr> <td></td> <td>5750 C $\geq 100.0\mu\text{F}$</td> </tr> </tbody> </table>	6.3V Tan δ	0.125 MAX *Condition	CLASS II (A,B)	1005 C $\geq 0.22\mu\text{F}$	1608 C $\geq 2.2\mu\text{F}$	2012 C $\geq 4.7\mu\text{F}$	3216 C $\geq 10.0\mu\text{F}$	3225 C $\geq 22.0\mu\text{F}$	4532 C $\geq 47.0\mu\text{F}$		5750 C $\geq 100.0\mu\text{F}$					
6.3V Tan δ	0.125 MAX *Condition																		
CLASS II (A,B)	1005 C $\geq 0.22\mu\text{F}$																		
	1608 C $\geq 2.2\mu\text{F}$																		
	2012 C $\geq 4.7\mu\text{F}$																		
	3216 C $\geq 10.0\mu\text{F}$																		
	3225 C $\geq 22.0\mu\text{F}$																		
	4532 C $\geq 47.0\mu\text{F}$																		
	5750 C $\geq 100.0\mu\text{F}$																		

Multilayer Ceramic Capacitor

NO	ITEM	PERFORMANCE	TEST CONDITION																
16	HIGH TEMPERATURE RESISTANCE	APPEARANCE	NO MECHANICAL DAMAGE SHALL OCCUR																
		CAPACITANCE	CHARACTERISTIC	CAP. CHANGE															
			CLASS I	WITHIN $\pm 3\%$ OR $\pm 0.3\text{pF}$, WHICHEVER IS LARGER															
			CLASS II	A,B	WITHIN $\pm 12.5\%$														
				F	WITHIN $\pm 30\%$ WITHIN $+30\sim 40\%$ 1005 C $> 0.47\mu\text{F}$ 1608 C $> 1.0\mu\text{F}$ 2012 C $> 4.7\mu\text{F}$ 3216 C $> 10.0\mu\text{F}$ 3225 C $> 22.0\mu\text{F}$ 4532 C $> 47.0\mu\text{F}$														
		Q CLASS I	30 pF AND OVER : $Q \geq 350$ 10 ~ 30 pF : $Q \geq 275 + 2.5 \times C$ LESS THAN 10 pF : $Q \geq 200 + 10 \times C$																
Tan δ CLASS II	<table border="1"> <thead> <tr> <th>CHAR.</th> <th>25V AND OVER</th> <th>16V</th> <th>10V</th> <th>6.3V</th> <th>4V</th> </tr> </thead> <tbody> <tr> <td>A,B</td> <td>0.05 MAX</td> <td>0.05 MAX</td> <td>0.05 MAX</td> <td>0.075 MAX</td> <td>0.1 MAX</td> </tr> <tr> <td>F</td> <td>0.075 MAX</td> <td>0.1 MAX (C < 1.0 μF) 0.125 MAX (C $\geq 1.0\mu\text{F}$)</td> <td>0.15 MAX</td> <td>0.195 MAX</td> <td>0.25 MAX</td> </tr> </tbody> </table>	CHAR.	25V AND OVER	16V	10V	6.3V	4V	A,B	0.05 MAX	0.05 MAX	0.05 MAX	0.075 MAX	0.1 MAX	F	0.075 MAX	0.1 MAX (C < 1.0 μF) 0.125 MAX (C $\geq 1.0\mu\text{F}$)	0.15 MAX	0.195 MAX	0.25 MAX
CHAR.	25V AND OVER	16V	10V	6.3V	4V														
A,B	0.05 MAX	0.05 MAX	0.05 MAX	0.075 MAX	0.1 MAX														
F	0.075 MAX	0.1 MAX (C < 1.0 μF) 0.125 MAX (C $\geq 1.0\mu\text{F}$)	0.15 MAX	0.195 MAX	0.25 MAX														
INSULATION RESISTANCE	MINIMUM INSULATION RESISTANCE: 1,000 M Ω OR 50 M $\Omega \cdot \mu\text{F}$ PRODUCT WHICHEVER IS SMALLER																		
			<p>APPLIED VOLTAGE : 150%, 200% OF RATED VOLTAGE TEST TIME : 1000 +48/-0 Hr. CURRENT APPLIED : 50mA MAX.</p> <table border="1"> <thead> <tr> <th>CHAR.</th> <th>TEMP.</th> </tr> </thead> <tbody> <tr> <td>CLASS I</td> <td>125 ± 3 $^{\circ}\text{C}$</td> </tr> <tr> <td rowspan="3">CLASS II</td> <td>A</td> <td>85 ± 3 $^{\circ}\text{C}$</td> </tr> <tr> <td>B</td> <td>125 ± 3 $^{\circ}\text{C}$</td> </tr> <tr> <td>F</td> <td>85 ± 3 $^{\circ}\text{C}$</td> </tr> </tbody> </table> <p><INITIAL MEASUREMENT> CLASS II SHOULD BE MEASURED INITIAL VALUE AFTER BE HEAT-TREATED FOR 1 HR IN 150$^{\circ}\text{C} \pm 0/-10^{\circ}\text{C}$ AND BE LEFT FOR 48\pm 4HR AT ROOM TEMPERATURE. <LATTER MEASUREMENT> CLASS I SHOULD BE MEASURED AFTER LEFT FOR 24\pm2 HRS IN ROOM TEMPERATURE AND HUMIDITY. CLASS II SHOULD BE MEASURED LATTER VALUE AFTER BE HEAT-TREATED FOR 1 HR IN 150$^{\circ}\text{C} \pm 0/-10^{\circ}\text{C}$ AND BE LEFT FOR 48\pm 4HR AT ROOM TEMPERATURE.</p> <table border="1"> <thead> <tr> <th></th> <th>*150% Authorization Conditions</th> </tr> </thead> <tbody> <tr> <td>CLASS II (A,B,F)</td> <td>1005 C $> 0.47\mu\text{F}$ 1608 C $\geq 2.2\mu\text{F}$ 2012 C $\geq 4.7\mu\text{F}$ 3216 C $\geq 10.0\mu\text{F}$ 3225 C $\geq 22.0\mu\text{F}$ 4532 C $\geq 47.0\mu\text{F}$ 5750 C $\geq 100.0\mu\text{F}$</td> </tr> </tbody> </table> <p>(TWICE OF RATED VOLTAGE WILL BE APPLIED TO ALL SERIES BUT ABOVE) ** HOWEVER, A/B \neq 1005 C $\geq 0.22\mu\text{F}$ SEE (FIG.3)</p>	CHAR.	TEMP.	CLASS I	125 ± 3 $^{\circ}\text{C}$	CLASS II	A	85 ± 3 $^{\circ}\text{C}$	B	125 ± 3 $^{\circ}\text{C}$	F	85 ± 3 $^{\circ}\text{C}$		*150% Authorization Conditions	CLASS II (A,B,F)	1005 C $> 0.47\mu\text{F}$ 1608 C $\geq 2.2\mu\text{F}$ 2012 C $\geq 4.7\mu\text{F}$ 3216 C $\geq 10.0\mu\text{F}$ 3225 C $\geq 22.0\mu\text{F}$ 4532 C $\geq 47.0\mu\text{F}$ 5750 C $\geq 100.0\mu\text{F}$	
CHAR.	TEMP.																		
CLASS I	125 ± 3 $^{\circ}\text{C}$																		
CLASS II	A	85 ± 3 $^{\circ}\text{C}$																	
	B	125 ± 3 $^{\circ}\text{C}$																	
	F	85 ± 3 $^{\circ}\text{C}$																	
	*150% Authorization Conditions																		
CLASS II (A,B,F)	1005 C $> 0.47\mu\text{F}$ 1608 C $\geq 2.2\mu\text{F}$ 2012 C $\geq 4.7\mu\text{F}$ 3216 C $\geq 10.0\mu\text{F}$ 3225 C $\geq 22.0\mu\text{F}$ 4532 C $\geq 47.0\mu\text{F}$ 5750 C $\geq 100.0\mu\text{F}$																		
17	TEMPERATURE CYCLE	APPEARANCE	NO MECHANICAL DAMAGE SHALL OCCUR																
		CAPACITANCE	CHARACTERISTIC	CAP. CHANGE															
			CLASS I	WITHIN $\pm 2.5\%$ OR $\pm 0.25\text{pF}$ WHICHEVER IS LARGER															
			CLASS II	A,B	WITHIN $\pm 7.5\%$														
				F	WITHIN $\pm 20\%$														
		Q CLASS I	30 pF AND OVER : $Q \geq 1000$ LESS THAN 30 pF : $Q \geq 400 + 20 \times C$																
Tan δ CLASS II	TO SATISFY THE SPECIFIED INITIAL VALUE																		
INSULATION RESISTANCE	TO SATISFY THE SPECIFIED INITIAL VALUE																		
			<p>CAPACITORS SHALL BE SUBJECTED TO FIVE CYCLES OF THE TEMPERATURE CYCLE AS FOLLOWING</p> <table border="1"> <thead> <tr> <th>STEP</th> <th>TEMP.($^{\circ}\text{C}$)</th> <th>TIME(MIN)</th> </tr> </thead> <tbody> <tr> <td>1</td> <td>MIN.RATED TEMP.+0/-3</td> <td>30</td> </tr> <tr> <td>2</td> <td>25</td> <td>2~3</td> </tr> <tr> <td>3</td> <td>MAX.RATED TEMP.+3/-0</td> <td>30</td> </tr> <tr> <td>4</td> <td>25</td> <td>2~3</td> </tr> </tbody> </table> <p>MEASURE AT ROOM TEMPERATURE AFTER COOLING FOR CLASS I : 24\pm2 Hr. CLASS II : 48\pm4 Hr.</p>	STEP	TEMP.($^{\circ}\text{C}$)	TIME(MIN)	1	MIN.RATED TEMP.+0/-3	30	2	25	2~3	3	MAX.RATED TEMP.+3/-0	30	4	25	2~3	
STEP	TEMP.($^{\circ}\text{C}$)	TIME(MIN)																	
1	MIN.RATED TEMP.+0/-3	30																	
2	25	2~3																	
3	MAX.RATED TEMP.+3/-0	30																	
4	25	2~3																	

Multilayer Ceramic Capacitor

CHARACTERISTIC GRAPH

ELECTRICAL CHARACTERISTICS

CAPACITANCE - TEMPERATURE CHARACTERISTICS

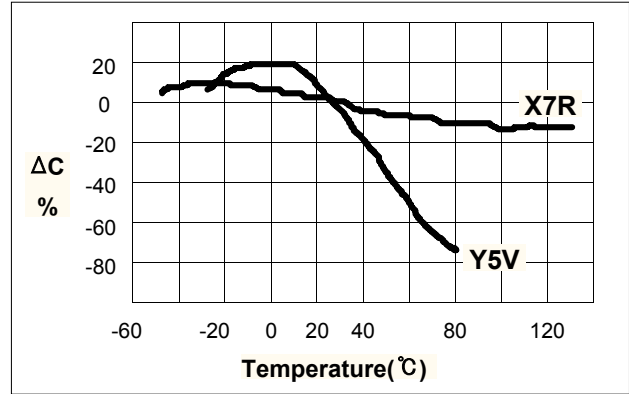
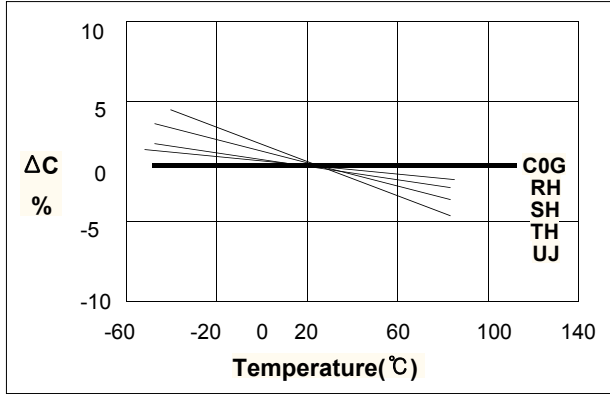

CAPACITANCE - DC VOLTAGE CHARACTERISTICS

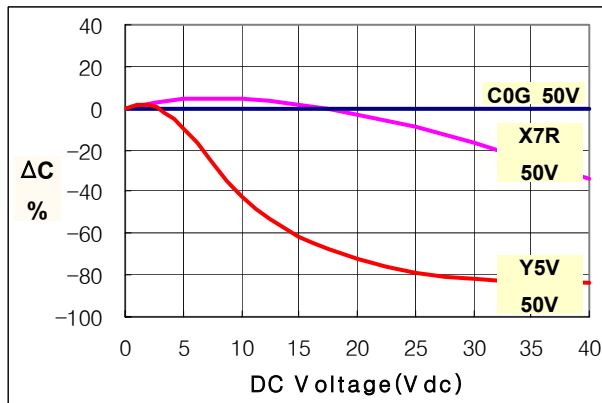

CAPACITANCE CHANGE - AGING

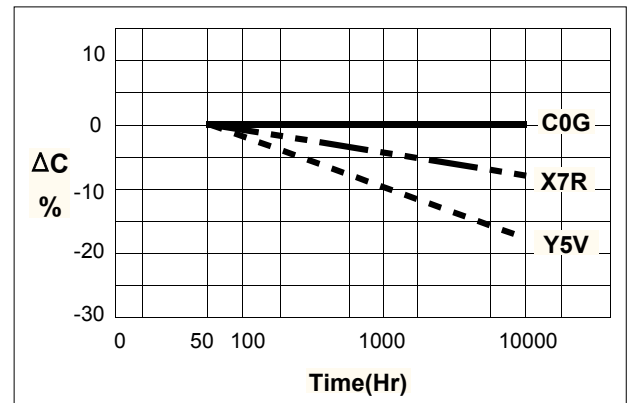

IMPEDANCE - FREQUENCY CHARACTERISTICS

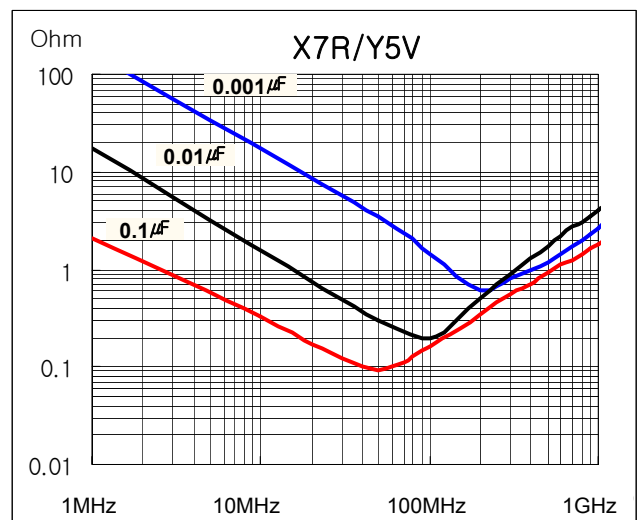
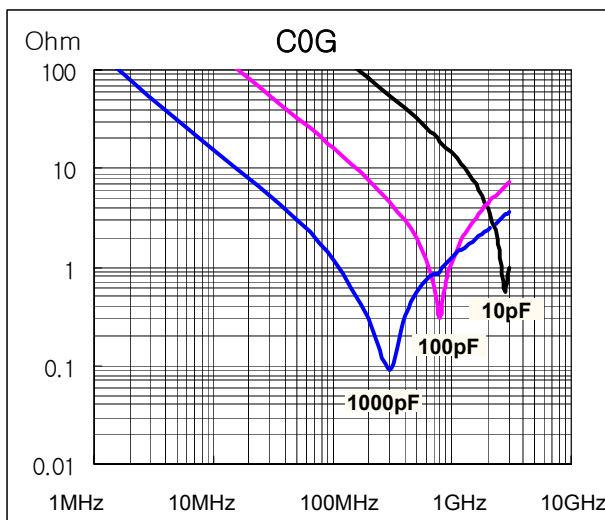

Multilayer Ceramic Capacitor

■ APPLICATION MANUAL

● Storage Condition

▶ Storage Environment

The electrical characteristics of MLCCs were degraded by the environment of high temperature or humidity. Therefore, the MLCCs shall be stored in the ambient temperature and the relative humidity of less than 40°C and 70%, respectively. Guaranteed storage period is within 6 months from the outgoing date of delivery.

▶ Corrosive Gases

Since the solderability of the end termination in MLCC was degraded by a chemical atmosphere such as chlorine, acid or sulfide gases, MLCCs must be avoid from these gases.

▶ Temperature Fluctuations

Since dew condensation may occur by the differences in temperature when the MLCCs are taken out of storage, it is important to maintain the temperature-controlled environment.

● Design of Land Pattern

When designing printed circuit boards, the shape and size of the lands must allow for the proper amount of solder on the capacitor. The amount of solder at the end terminations has a direct effect on the crack. The crack in MLCC will be easily occurred by the tensile stress which was due to too much amount of solder. In contrast, if too little solder is applied, the termination strength will be insufficiently. Use the following illustrations as guidelines for proper land design.

Recommendation of Land Shape and Size

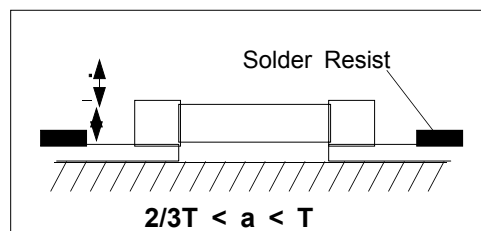
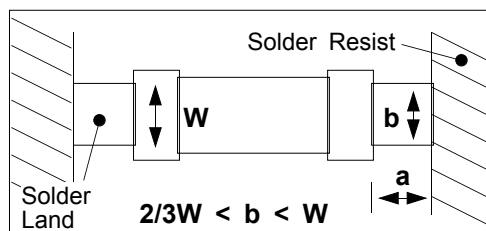

● Adhesives

When flow soldering the MLCCs, apply the adhesive in accordance with the following conditions.

▶ Requirements for Adhesives

They must have enough adhesion, so that, the chips will not fall off or move during the handling of the circuit board.

They must maintain their adhesive strength when exposed to soldering temperature.

They should not spread or run when applied to the circuit board.

They should harden quickly.

They should not corrode the circuit board or chip material.

Multilayer Ceramic Capacitor

They should be a good insulator.

They should be non-toxic, and not produce harmful gases, nor be harmful when touched.

▶ Application Method

It is important to use the proper amount of adhesive. Too little and much adhesive will cause poor adhesion and overflow into the land, respectively.

▶ Adhesive hardening Characteristics

To prevent oxidation of the terminations, the adhesive must harden at 160°C or less, within 2 minutes or less.

● Mounting

▶ Mounting Head Pressure

Excessive pressure will cause crack to MLCCs. The pressure of nozzle will be 300g maximum during mounting.

▶ Bending Stress

When double-sided circuit boards are used, MLCCs first are mounted and soldered onto one side of the board. When the MLCCs are mounted onto the other side, it is important to support the board as shown in the illustration. If the circuit board is not supported, the crack occur to the ready-installed MLCCs by the bending stress.

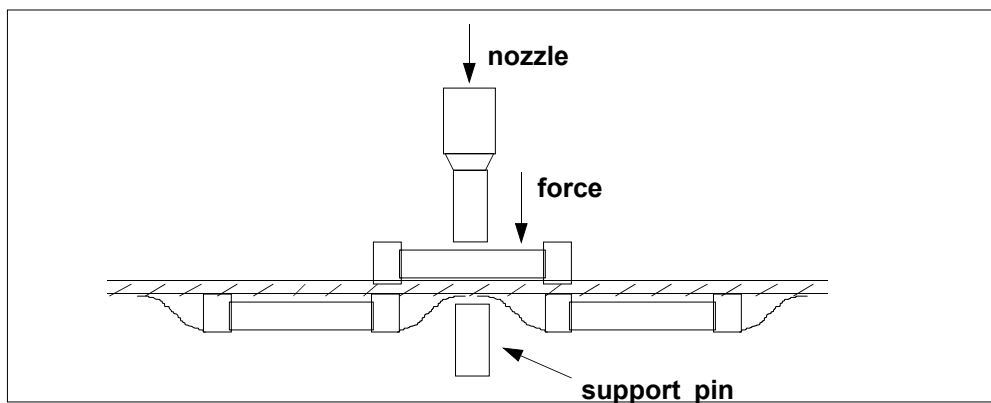

● Flux

Although the solderability increased by the highly-activated flux, increase of activity in flux may also degrade the insulation of the chip capacitors. To avoid such degradation, it is recommended that a mildly activated rosin flux(less than 0.2% chlorine) be used.

Multilayer Ceramic Capacitor

● Soldering

Since a multilayer ceramic chip capacitor comes into direct contact with melted solder during soldering, it is exposed to potentially mechanical stress caused by the sudden temperature change. The capacitor may also be subject to silver migration, and to contamination by the flux. Because of these factors, soldering technique is critical.

▶ Soldering Methods

Method	Classification	
Reflow soldering	- Overall heating	- Infrared rays - Hot plate - VPS(vapor phase)
	- Local heating	- Air heater - Laser - Light beam
Flow soldering	- Single wave - Double wave	-

* We recommend the reflow soldering method.

▶ Soldering Profile

To avoid crack problem by sudden temperature change, follow the temperature profile in the adjacent graph.

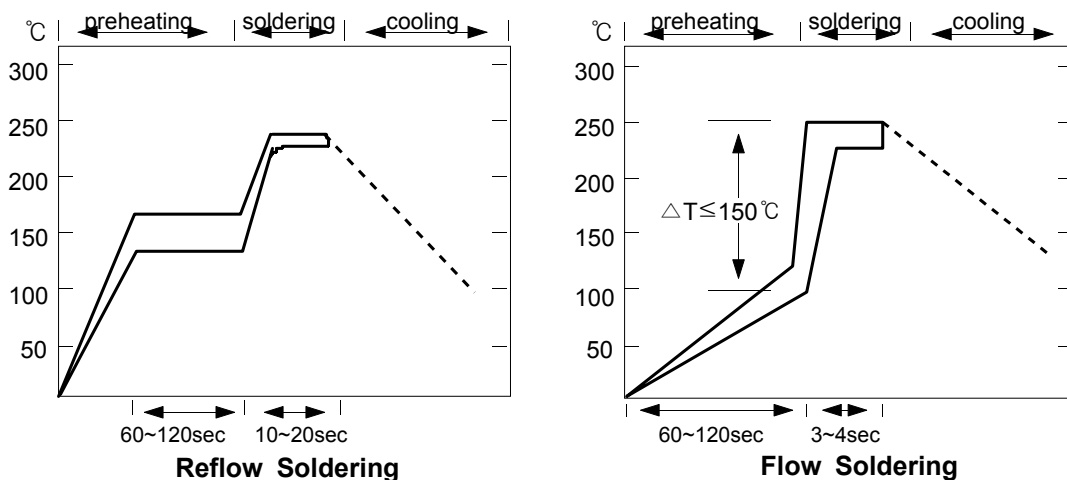

▶ Manual Soldering

Manual soldering can pose a great risk of creating thermal cracks in chip capacitors. The hot soldering iron tip comes into direct contact with the end terminations, and operator's carelessness may cause the tip of the soldering iron to come into direct contact with the ceramic body of the capacitor. Therefore the soldering iron must be handled carefully, and close attention must be paid to the selection of the soldering iron tip and to temperature control of the tip.

Multilayer Ceramic Capacitor

► Amount of Solder

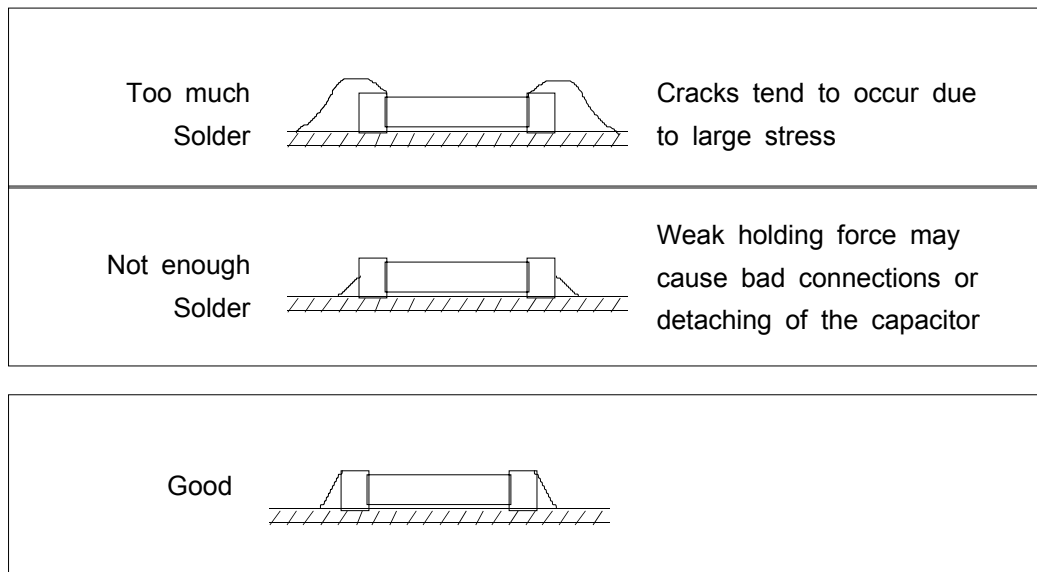

► Cooling

Natural cooling using air is recommended. If the chips are dipped into solvent for cleaning, the temperature difference (ΔT) must be less than 100°C

6-6. Cleaning

If rosin flux is used, cleaning usually is unnecessary. When strongly activated flux is used, chlorine in the flux may dissolve into some types of cleaning fluids, thereby affecting the chip capacitors. This means that the cleaning fluid must be carefully selected, and should always be new.

► Notes for Separating Multiple, Shared PC Boards.

A multi-PC board is separated into many individual circuit boards after soldering has been completed. If the board is bent or distorted at the time of separation, cracks may occur in the chip capacitors. Carefully choose a separation method that minimizes the bending of the circuit board.

Multilayer Ceramic Capacitor

CROSS REFERENCE

P/N	COMPANY	SAMSUNG	AVX	JOHANSON	KEMET	KYOCERA	MURATA	NOVACAP	PANASONIC	ROHM	TAIYO YUDEN	TDK	VITRAMON
① COMPANY	MODEL(MLCC)	CL	-	-	C	CM	GRM	-	ECJ	MCH	MK	C	VJ
② SIZE (EIA/JIS)	0201(0603)	03	-	-	-	03	33	-	Z	-	063	0603	-
	0402(1005)	05	0402	R07	0402	05	36	0402	0	15	105	1005	0402
	0603(1608)	10	0603	R14	0603	105	39	0603	1	18	107	1608	0603
	0805(2012)	21	0805	R15	0805	21	40	0805	2	21	212	2012	0805
	1206(3216)	31	1206	R18	1206	316	42-6	1206	3	31	316	3216	1206
	1210(3225)	32	1210	S41	1210	32	42-2	1210	4	32	325	3225	1210
	1808(4520)	42	1808	R29	1808	42	-	1808	-	-	-	4520	1808
	1812(4532)	43	1812	S43	1812	43	43-2	1812	-	43	432	4532	1812
③ TEMPERATURE CHARACTERISTIC	COG(NPO)	C	A	N	G	CG	COG/CH	N	C	A	C	COG/CH	A
	P2H(N150)	P	S	-	-	P	P2H	-	P	-	P	PH	-
	R2H(N220)	R	1	-	-	R	R2H	-	R	-	R	RH	-
	S2H(N330)	S	3	-	-	S	S2H	-	S	-	S	SH	-
	T2H(N470)	T	O	-	-	T	T2H	-	T	-	T	TH	-
	U2J(N750)	U	Z	-	-	U	U2J	-	U	UJ	U	UJ	-
	S2L	L	Y	-	-	SL	SL	-	G	SL	SL	SL	-
	X7R	B	C	W	R(X)	X7R	X7R	B	B	C	BJ	X7R(B)	Y(X)
	Z5U	E	E	Z	U	-	Z5U	Z	-	E	-	Z5U	U
Y5V	F	G	Y	V	Y5V	Y5V	Y	F	F	F	Y5V	-	
④ NOMINAL CAPACITANCE		EX) 103=10,000pF 221=220pF 225=2,200,000pF=2.2μF 1R5=1.5pF 010=1pF											
⑤ CAPACITANCE TOLERANCE		B:±0.1pF C:±0.25pF D:±0.5pF F:±1% G:±2% J:±5% K:±10% M:±20% Z:-20~+80%											
⑥ RATED VOLTAGE	6.3V	Q	6	-	9	06	6.3	-	0J	-	J	0J	-
	10 V	P	Z	100	8	10	10	-	1A	4	L	1A	-
	16 V	O	Y	160	4	16	16	160	1C	3	E	1C	J
	25 V	A	3	250	3	25	25	250	1E	2	T	1E	X
	50 V	B	5	500	5	50	50	500	1H	5	U	1H	A
	100 V	C	1	101	1	100	100	101	2A	1	-	2A	B
	200V	D	2	201	2	200	200	201	2D	-	-	-	C
	250V	E	V	-	-	250	250	251	-	-	-	2E	-
	500V	G	7	501	-	500	500	501	-	-	-	-	E
	630V	H	-	-	-	630	630	-	-	-	-	2J	-
	1000V	I	A	102	-	1000	1K	102	-	-	-	3A	G
	2000V	J	G	202	-	2000	2K	202	-	-	-	3D	-
3000V	K	H	302	-	3000	3K	302	-	-	-	3F	H	
4000V	-	J	-	-	4000	-	402	-	-	-	-	-	
⑦ TERMINATION	NICKEL BARRIER	N	T	V	C	A	(GRM)	N	-	(MCH)	-	-	X
	Ag/Pd	P	1	-	-	B	(GR)	P	-	(MC)	-	-	F
⑧ PACKAGE	BULK(VINYL)	B	9	(NONE)	-	B	PB	*	X	-	B	B	B
	PAPER TAPING	C	2, 4	T, R	-	T, L	PT	T	E, V, W	K, L	T	T	C, P
	PLASTIC TAPING	E	1, 3	E, U	-	H, N	PT	-	F, Y	P, Q	T	-	T, R
	BULK CASE	P	7	-	-	C	PC	-	C	C	-	-	G

Multilayer Ceramic Capacitor

► SAMSUNG : CL10B104KA8NNC

CL	10	B	104	K	A	8	N	N	N	C
Series	Size	Dielectric	Capacitance	Tolerance	Voltage	Thickness	Electrode/ Termination/ Plating	Products	Special	Packaging
03 = 0201 05 = 0402 10 = 0603 21 = 0805 31 = 1206 32 = 1210 43 = 1812 55 = 2220	C = C0G P = P2H R = R2H S = S2H T = T2H U = U2H L = S2L B = X7R A = X5R F = Y5V	2 significant figures + number of zeros Use "R" for decimal point	A = ±0.05pF B = ±0.1pF C = ±0.25pF D = ±0.5pF F = ±1% G = ±2% J = ±5% K = ±10% M = ±20% Z = +80,-20%	Q = 6.3V P = 10V O = 16V A = 25V B = 50V C = 100V D = 200V E = 250V G = 500V H = 630V I = 1000V	3 = 0.30 5 = 0.50 8 = 0.80 A = 0.65 C = 0.85 H = 1.60 I = 2.00 J = 2.50 L = 3.20	A = Pd/Ag/ Sn 100% N = Ni/Cu/ Sn 100% G = Cu/Cu/ Sn 100%	A = Array (2-element) B = Array (4-element) C = High - Q L = LICC N = Normal P = Automotive W = 3 terminal chip	Various	B = Bulk P = Cassette C = Paper 7" D = Paper 13" (10,000EA) E = Embossing 7" F = Embossing 13" L = Paper 13" (15,000EA) O = Paper 10" S = Embossing 10"	

► AVX : 06033C104KAT2A

0603	3	C	104	K	A	T	2	A
Size	Voltage	Dielectric	Capacitance	Tolerance	Failure Rate	Termination	Packaging	Special
0201 0402 0603 0805 1206 1210 1812 2220 2225	4 = 4V 6 = 6.3V Z = 10V Y = 16V 3 = 25V B = 50V C = 100V D = 200V E = 250V G = 500V I = 1000V	A = C0G C = X7R D = X5R E = Z5U G = Y5V	2 significant figures + number of zeros Use "R" for decimal point	B = ±0.1pF C = ±0.25pF D = ±0.5pF F = ±1% G = ±2% J = ±5% K = ±10% M = ±20% Z = +80, -20% P = GMV,+100,-0%	A = N/A	T = Sn 100% 7 = Gold Plated 1 = Pd/Ag	2 = 7" Reel 4 = 13" Reel 7 = Cassette 9 = Bulk	A = Standard T = 0.66mm S = 0.56mm R = 0.46mm

► JOHANSON : 250R14W104KV6T

250	R14	W	104	K	V	6	T
Voltage	Size	Dielectric	Capacitance	Tolerance	Termination	Marking	Packaging
2 significant figures + number of zeros	R07 = 0402 R14 = 0603 R15 = 0805 R18 = 1206 S41 = 1210 S43 = 1812 S47 = 2220 S48 = 2225 S49 = 1825 S54 = 3640	N = C0G W = X7R X = X5R Z = Z5U Y = Y5V	2 significant figures + number of zeros Use "R" for decimal point	B = ±0.1pF C = ±0.25pF D = ±0.5pF F = ±1% G = ±2% J = ±5% K = ±10% M = ±20% Z = +80, -20% P = GMV,+100,-0%	V = Ni Barrier	4 = No Mark 6 = Marking	E = 7" Reel Plastic T = 7" Reel Paper R = 13" Reel Paper U = 13" Reel Plastic None = Bulk

► KEMET : C0603C104K3RAC

C	0603	C	104	K	3	R	A	C
Series	Size	Specification	Capacitance	Tolerance	Voltage	Dielectric	Failure Rate	Termination
0402 0603 0805 1206 1210 1812 2220 2225	C = Standard A = GR900 P = Mil-C-55681 CDR01-CDR06 N = Mil-C-55681 CDR31-CDR35 Z = Mil-C-123 E = Mil Equivalent (Group A Only)	2 significant figures + number of zeros Use "R" for decimal point	B = ±0.1pF C = ±0.25pF D = ±0.5pF F = ±1% G = ±2% J = ±5% K = ±10% M = ±20% Z = +80, -20% P = +100, 0%	9 = 6.3V 8 = 10V 4 = 16V 3 = 25V 5 = 50V 1 = 100V 2 = 200V	G = C0G R = X7R P = X5R U = Z5U X = BX(Mil) V = Y5V	A = Standard M = 1.0 (Mil) P = 0.1 (Mil) R = 0.01 (Mil) S = 0.001 (Mil)	C = Ni w/Tin Plate H = Ni w/Solder T = Silver G = Gold Plated	

Multilayer Ceramic Capacitor

► KYOCERA : CM105X7R104K25AT

CM	105	X7R	104	K	25	A	T
Series	Size	Dielectric	Capacitance	Tolerance	Voltage	Termination	Packaging
	03 = 0201 05 = 0402 105 = 0603 21 = 0805 316 = 1206 32 = 1210 42 = 1808 43 = 1812 55 = 2220	CG X8R X7R X5R Z5U Y5V Y5U	2 significant figures + number of zeros Use "R" for decimal point	B = $\pm 0.1\text{pF}$ C = $\pm 0.25\text{pF}$ D = $\pm 0.5\text{pF}$ F = $\pm 1\%$ G = $\pm 2\%$ J = $\pm 5\%$ K = $\pm 10\%$ M = $\pm 20\%$ Z = +80, -20% P = +100, 0%	04 = 4V 06 = 6.3V 10 = 10V 16 = 16V 25 = 25V 50 = 50V 100 = 100V 250 = 250V 500 = 500V 1000 = 1000V	A = Ni Barrier	T = 7" Reel (4mm Pitch) L = 13" Reel (4mm Pitch) H = 7" Reel (2mm Pitch) N = 13" Reel (2mm Pitch) B = Bulk (Vinyl Bags) C = Bulk Cassette

► MURATA : GRM188R71E104KA01D

GRM	18	8	R7	1E	104	K	A01	D
Series	Size	Thickness	Dielectric	Voltage	Capacitance	Tolerance	Individual Specification Code	Packaging
Ni Barrier	03 = 0201 15 = 0402 18 = 0603 21 = 0805 31 = 1206 32 = 1210 42 = 1808 43 = 1812 55 = 2220	3 = 0.3mm 5 = 0.5mm 8 = 0.8mm A = 1.0mm B = 1.25mm C = 1.6mm D = 2.0mm E = 2.5mm F = 3.2mm	5C = C0G R7 = X7R R6 = X5R E4 = Z5U F5 = Y5V	0J = 6.3V 1A = 10V 1C = 16V 1E = 25V 1H = 50V 2A = 100V 2E = 250V 2H = 500V 3A = 1000V	2 significant figures + number of zeros Use "R" for decimal point	B = $\pm 0.1\text{pF}$ C = $\pm 0.25\text{pF}$ D = $\pm 0.5\text{pF}$ F = $\pm 1\%$ G = $\pm 2\%$ J = $\pm 5\%$ K = $\pm 10\%$ M = $\pm 20\%$ Z = +80,-20% P = +100, 0%		D = 7" Reel Paper L = 7" Reel Plastic J = 13" Reel Paper K = 13" Reel Plastic B = Bulk C = Bulk Cassette T = Bulk Tray

► NOVACAP : 0603B104K250N_TM

1206	B	104	K	250	N	-	T	M
Size	Dielectric	Capacitance	Tolerance	Voltage	Termination	Thickness	Packaging	Marking
0402 0603 0805 1005 1206 1210 1808 1812 2220	N = C0G B = X7R X = BX Z = Z5U Y = Y5V	2 significant figures + number of zeros Use "R" for decimal point	B = $\pm 0.1\text{pF}$ C = $\pm 0.25\text{pF}$ D = $\pm 0.5\text{pF}$ F = $\pm 1\%$ G = $\pm 2\%$ J = $\pm 5\%$ K = $\pm 10\%$ M = $\pm 20\%$ Z = +80,-20% P = +100, 0%	2 significant figures + number of zeros	P = Pd/Ag N = Ni Barrier (Sn 100%) Y = Ni Barrier (Sn/Pb)	Per Specified	T = Reel None = Bulk W = Waffle Pack	

► PANASONIC : ECJ1EB1E104K

ECJ	1	E	B	1E	104	K
Series	Size	Packaging	Dielectric	Voltage	Capacitance	Tolerance
	Z = 0201 0 = 0402 1 = 0603 2 = 0805 3 = 1206 4 = 1210	X = Bulk E = Paper 2mm V = Paper 4mm F, Y = Plastic 4mm W = Large Reels 2mm Z = Large Reels 4mm C = Bulk Cassette	C = C0G B = X7R, X5R F = Y5V	0J = 6.3V 1A = 10V 1C = 16V 1E = 25V 1H = 50V 2A = 100V 2D = 200V	2 significant figures + number of zeros Use "R" for decimal point	C = $\pm 0.25\text{pF}$ D = $\pm 0.5\text{pF}$ F = $\pm 1\%$ J = $\pm 5\%$ K = $\pm 10\%$ M = $\pm 20\%$ Z = +80, -20%

Multilayer Ceramic Capacitor

▶ ROHM : MCH182C104KKN

<u>MCH</u>	<u>18</u>	<u>2</u>	<u>C</u>	<u>104</u>	<u>K</u>	<u>K</u>	<u>N</u>
Series	Size	Voltage e	Dielectric	Capacitance	Tolerance	Packaging	Marking/Thickness
	15 = 0402 18 = 0603 21 = 0805 31 = 1206 32 = 1210 43 = 1812	4 = 10V 3 = 16V 2 = 25V 5 = 50V	A = C0G C = X7R F = Y5V	2 significant figures + number of zeros Use "R" for decimal point	B = ±0.1pF C = ±0.25pF D = ±0.5pF F = ±1% G = ±2% J = ±5% K = ±10% M = ±20% Z = +80,-20% P = +100, 0%	K = 7" Reel Paper P = 7" Reel Plastic L = 13" Reel Paper Q = 13" Reel Plastic B = Bulk C = Bulk Cassette	N = Marked Special Thickness

▶ TAIYO-YUDEN : TMK107BJ104K_T

<u>T</u>	<u>M</u>	<u>K</u>	<u>107</u>	<u>BJ</u>	<u>104</u>	<u>K</u>	-	<u>T</u>
Voltage	Type	Termination	Size	Dielectric	Capacitance	Tolerance	Special	Packaging
A = 4V J = 6.3V L = 10V E = 16V T = 25V U = 50V	M = Multilayer V = Hi Q	K = Ni Barrier	105 = 0402 107 = 0603 212 = 0805 316 = 1206 325 = 1210 432 = 1812 550 = 2220	CG = C0G CH = C0H CJ = C0J CK = C0K BJ = X5R, X7R F = Y5V	2 significant figures + number of zeros Use "R" for decimal point	C = ±0.25pF D = ±0.5pF F = ±1% G = ±2% J = ±5% K = ±10% M = ±20% Z = +80,-20%	Various	T = Reel B = Bulk

▶ TDK : C1608X7R1E104KT

<u>C</u>	<u>1608</u>	<u>X7R</u>	<u>1E</u>	<u>104</u>	<u>K</u>	<u>T</u>
Series	Size	Dielectric	Voltage	Capacitance	Tolerance	Packaging
	0603 = 0201 1005 = 0402 1608 = 0603 2012 = 0805 3216 = 1206 3225 = 1210 4532 = 1812 5650 = 2220	CG X7R Z5U Y5V	0J = 6.3V 1A = 10V 1C = 16V 1E = 25V 1H = 50V	2 significant figures + number of zeros Use "R" for decimal point	C = ±0.25pF D = ±0.5pF F = ±1% G = ±2% J = ±5% K = ±10% M = ±20% Z = +80, -20%	T = Reel B = Bulk

▶ VITRAMON : VJ0603Y104KXXMC

<u>VJ</u>	<u>0603</u>	<u>Y</u>	<u>104</u>	<u>K</u>	<u>X</u>	<u>X</u>	<u>M</u>	<u>C</u>
Series	Size	Dielectric	Capacitance	Tolerance	Termination	Voltage	Marking	Packaging
	0402 0603 0805 1206 1210 1812 2225	X = BX A,N = C0G Y = X7R U = Z5U H = X8R	2 significant figures + number of zeros Use "R" for decimal point	B = ±0.1pF C = ±0.25pF D = ±0.5pF F = ±1% G = ±2% J = ±5% K = ±10% M = ±20% Z = +80, -20% P = +100, 0%	X = Silver, Ni Barrier Tin Plated	J = 16V X = 25V A = 50V B = 100V C = 200V	M = Marking A = No Marking	C = 7" Reel Paper T = 7" Reel Plastic P = 13" Reel Paper R = 13" Reel Plastic B = Bulk