

# BAS70 series; 1PS7xSB70 series

General-purpose Schottky diodes

Rev. 09 — 13 January 2010

Product data sheet

## 1. Product profile

### 1.1 General description

General-purpose Schottky diodes in small Surface-Mounted Device (SMD) plastic packages.

Table 1. Product overview

| Type number | Package |       | Configuration       |
|-------------|---------|-------|---------------------|
|             | NXP     | JEITA |                     |
| 1PS76SB70   | SOD323  | SC-76 | single diode        |
| 1PS79SB70   | SOD523  | SC-79 | single diode        |
| BAS70       | SOT23   | -     | single diode        |
| BAS70H      | SOD123F | -     | single diode        |
| BAS70L      | SOD882  | -     | single diode        |
| BAS70W      | SOT323  | SC-70 | single diode        |
| BAS70-04    | SOT23   | -     | dual series         |
| BAS70-04W   | SOT323  | SC-70 | dual series         |
| BAS70-05    | SOT23   | -     | dual common cathode |
| BAS70-05W   | SOT323  | SC-70 | dual common cathode |
| BAS70-06    | SOT23   | -     | dual common anode   |
| BAS70-06W   | SOT323  | SC-70 | dual common anode   |
| BAS70-07    | SOT143B | -     | dual isolated       |
| BAS70-07S   | SOT363  | SC-88 | dual isolated       |
| BAS70-07V   | SOT666  | -     | dual isolated       |
| BAS70VV     | SOT666  | -     | triple isolated     |
| BAS70XY     | SOT363  | SC-88 | quadruple; 2 series |

### 1.2 Features

- High switching speed
- High breakdown voltage
- Low leakage current
- Low capacitance

### 1.3 Applications

- Ultra high-speed switching
- Voltage clamping

## 1.4 Quick reference data


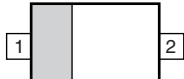


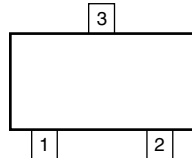
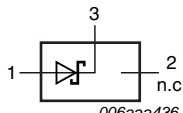
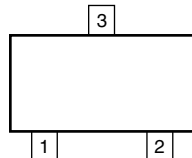
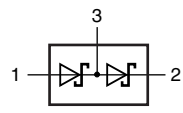
Table 2. Quick reference data

| Symbol           | Parameter       | Conditions           | Min | Typ | Max | Unit |
|------------------|-----------------|----------------------|-----|-----|-----|------|
| <b>Per diode</b> |                 |                      |     |     |     |      |
| $I_F$            | forward current |                      | -   | -   | 70  | mA   |
| $V_F$            | forward voltage | $I_F = 1 \text{ mA}$ | [1] | -   | 410 | mV   |
| $V_R$            | reverse voltage |                      | -   | -   | 70  | V    |

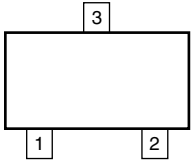
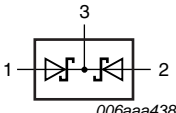
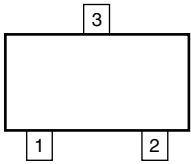
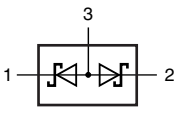
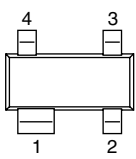
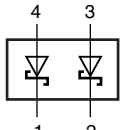
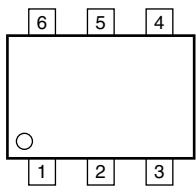
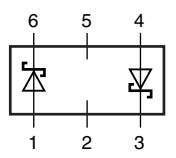
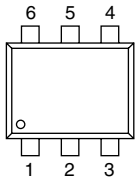
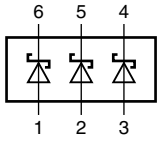
[1] Pulse test:  $t_p \leq 300 \mu\text{s}$ ;  $\delta \leq 0.02$ .

## 2. Pinning information

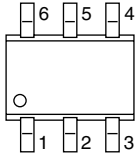
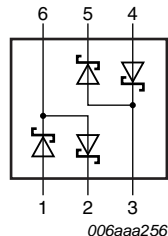
Table 3. Pinning

| Pin                                 | Description                           | Simplified outline  | Symbol   |
|-------------------------------------|---------------------------------------|---|--|
| <b>BAS70H; 1PS76SB70; 1PS79SB70</b> |                                       |   |  |
| 1                                   | cathode                               | [1]   | <br>sym001      |
| 2                                   | anode                                 | <br>001aab540              |  |
| <b>BAS70L</b>                       |                                       |   |  |
| 1                                   | cathode                               | [1]   | <br>sym001    |
| 2                                   | anode                                 | <br>Transparent top view |  |
| <b>BAS70; BAS70W</b>                |                                       |   |  |
| 1                                   | anode                                 | <br>006aaa144             | <br>006aaa436 |
| 2                                   | not connected                         |   |  |
| 3                                   | cathode                               |   |  |
| <b>BAS70-04; BAS70-04W</b>          |                                       |   |  |
| 1                                   | anode (diode 1)                       | <br>006aaa144             | <br>006aaa437 |
| 2                                   | cathode (diode 2)                     |   |  |
| 3                                   | cathode (diode 1),<br>anode (diode 2) |   |  |

**Table 3. Pinning ...continued**

| Pin                         | Description                             | Simplified outline  | Symbol   |
|-----------------------------|---|---|--|
| <b>BAS70-05; BAS70-05W</b>  |   |   |  |
| 1                           | anode (diode 1)                         |  <p>006aaa144</p>  |  <p>006aaa438</p>   |
| 2                           | anode (diode 2)                         |   |  |
| 3                           | cathode (diode 1),<br>cathode (diode 2) |   |  |
| <b>BAS70-06; BAS70-06W</b>  |   |   |  |
| 1                           | cathode (diode 1)                       |  <p>006aaa144</p>  |  <p>006aaa439</p>   |
| 2                           | cathode (diode 2)                       |   |  |
| 3                           | anode (diode 1),<br>anode (diode 2)     |   |  |
| <b>BAS70-07</b>             |   |   |  |
| 1                           | cathode (diode 1)                       |                  |  <p>006aaa434</p> |
| 2                           | cathode (diode 2)                       |   |  |
| 3                           | anode (diode 2)                         |   |  |
| 4                           | anode (diode 1)                         |   |  |
| <b>BAS70-07S; BAS70-07V</b> |   |   |  |
| 1                           | anode (diode 1)                         |  <p>001aab555</p> |  <p>006aaa440</p> |
| 2                           | not connected                           |   |  |
| 3                           | cathode (diode 2)                       |   |  |
| 4                           | anode (diode 2)                         |   |  |
| 5                           | not connected                           |   |  |
| 6                           | cathode (diode 1)                       |   |  |
| <b>BAS70VV</b>              |   |   |  |
| 1                           | anode (diode 1)                         |                  |  <p>sym046</p>    |
| 2                           | anode (diode 2)                         |   |  |
| 3                           | anode (diode 3)                         |   |  |
| 4                           | cathode (diode 3)                       |   |  |
| 5                           | cathode (diode 2)                       |   |  |
| 6                           | cathode (diode 1)                       |   |  |

**Table 3. Pinning ...continued**

| Pin            | Description                           | Simplified outline  | Symbol  |
|----------------|---------------------------------------|---|---|
| <b>BAS70XY</b> |                                       |   |   |
| 1              | anode (diode 1)                       |  |  |
| 2              | cathode (diode 2)                     |   |   |
| 3              | anode (diode 3),<br>cathode (diode 4) |   |   |
| 4              | anode (diode 4)                       |   |   |
| 5              | cathode (diode 3)                     |   |   |
| 6              | cathode (diode 1),<br>anode (diode 2) |   |   |

[1] The marking bar indicates the cathode.

## 3. Ordering information

**Table 4. Ordering information**

| Type number | Package |   | Version |
|-------------|---------|---|---------|
|             | Name    | Description   |         |
| 1PS76SB70   | SC-76   | plastic surface-mounted package; 2 leads                                      | SOD323  |
| 1PS79SB70   | SC-79   | plastic surface-mounted package; 2 leads                                      | SOD523  |
| BAS70       | -       | plastic surface-mounted package; 3 leads                                      | SOT23   |
| BAS70H      | -       | plastic surface-mounted package; 2 leads                                      | SOD123F |
| BAS70L      | -       | leadless ultra small plastic package; 2 terminals;<br>body 1.0 × 0.6 × 0.5 mm | SOD882  |
| BAS70W      | SC-70   | plastic surface-mounted package; 3 leads                                      | SOT323  |
| BAS70-04    | -       | plastic surface-mounted package; 3 leads                                      | SOT23   |
| BAS70-04W   | SC-70   | plastic surface-mounted package; 3 leads                                      | SOT323  |
| BAS70-05    | -       | plastic surface-mounted package; 3 leads                                      | SOT23   |
| BAS70-05W   | SC-70   | plastic surface-mounted package; 3 leads                                      | SOT323  |
| BAS70-06    | -       | plastic surface-mounted package; 3 leads                                      | SOT23   |
| BAS70-06W   | SC-70   | plastic surface-mounted package; 3 leads                                      | SOT323  |
| BAS70-07    | -       | plastic surface-mounted package; 4 leads                                      | SOT143B |
| BAS70-07S   | SC-88   | plastic surface-mounted package; 6 leads                                      | SOT363  |
| BAS70-07V   | -       | plastic surface-mounted package; 6 leads                                      | SOT666  |
| BAS70VV     | -       | plastic surface-mounted package; 6 leads                                      | SOT666  |
| BAS70XY     | SC-88   | plastic surface-mounted package; 6 leads                                      | SOT363  |

## 4. Marking

Table 5. Marking codes

| Type number | Marking code <sup>[1]</sup> | Type number | Marking code <sup>[1]</sup> |
|-------------|-----------------------------|-------------|-----------------------------|
| 1PS76SB70   | S2                          | BAS70-05W   | 75*                         |
| 1PS79SB70   | G                           | BAS70-06    | 76*                         |
| BAS70       | 73*                         | BAS70-06W   | 76*                         |
| BAS70H      | AH                          | BAS70-07    | 77*                         |
| BAS70L      | S8                          | BAS70-07S   | 77*                         |
| BAS70W      | 73*                         | BAS70-07V   | 77                          |
| BAS70-04    | 74*                         | BAS70VV     | N1                          |
| BAS70-04W   | 74*                         | BAS70XY     | 70*                         |
| BAS70-05    | 75*                         | -           | -                           |

- [1] \* = -: made in Hong Kong  
 \* = p: made in Hong Kong  
 \* = t: made in Malaysia  
 \* = W: made in China

## 5. Limiting values

Table 6. Limiting values

In accordance with the Absolute Maximum Rating System (IEC 60134).

| Symbol           | Parameter                           | Conditions                              | Min   | Max  | Unit |
|------------------|-------------------------------------|---|-------|------|------|
| <b>Per diode</b> |                                     |   |       |      |      |
| $V_R$            | reverse voltage                     |   | -     | 70   | V    |
| $I_F$            | forward current                     |   | -     | 70   | mA   |
| $I_{FRM}$        | repetitive peak forward current     | $t_p \leq 1 \text{ s}; \delta \leq 0.5$ | -     | 70   | mA   |
| $I_{FSM}$        | non-repetitive peak forward current | $t_p \leq 10 \text{ ms}$                | [1] - | 100  | mA   |
| $T_j$            | junction temperature                |   | -     | 150  | °C   |
| $T_{amb}$        | ambient temperature                 |   | -65   | +150 | °C   |
| $T_{stg}$        | storage temperature                 |   | -65   | +150 | °C   |

- [1]  $T_j = 25 \text{ °C}$  prior to surge.

## 6. Thermal characteristics

**Table 7. Thermal characteristics**

| Symbol            | Parameter  | Conditions  | Min | Typ | Max | Unit |
|-------------------|--|-------------|-----|-----|-----|------|
| <b>Per device</b> |  |             |     |     |     |      |
| $R_{th(j-a)}$     | thermal resistance from junction to ambient      | in free air | [1] |     |     |      |
|                   | SOT23  |             | -   | -   | 500 | K/W  |
|                   | SOT143B  |             | -   | -   | 500 | K/W  |
|                   | SOT363 (BAS70-07S)                               |             | -   | -   | 416 | K/W  |
|                   | SOT666 (BAS70VV)                                 |             | [2] | -   | 700 | K/W  |
|                   | SOT666 (BAS70-07V)                               |             | [2] | -   | 416 | K/W  |
|                   | SOD123F  |             | [2] | -   | 330 | K/W  |
|                   | SOD323   |             | -   | -   | 450 | K/W  |
|                   | SOD523   |             | [2] | -   | 450 | K/W  |
|                   | SOD882   |             | [2] | -   | 500 | K/W  |
| SOT323            |  | -           | -   | 625 | K/W |      |
| $R_{th(j-sp)}$    | thermal resistance from junction to solder point |             |     |     |     |      |
|                   | SOT363 (BAS70XY)                                 |             | [3] | -   | 260 | K/W  |

[1] Device mounted on an FR4 Printed-Circuit Board (PCB), single-sided copper, tin-plated and standard footprint.

[2] Reflow soldering is the only recommended soldering method.

[3] Soldering point at pins 2, 3, 5 and 6.

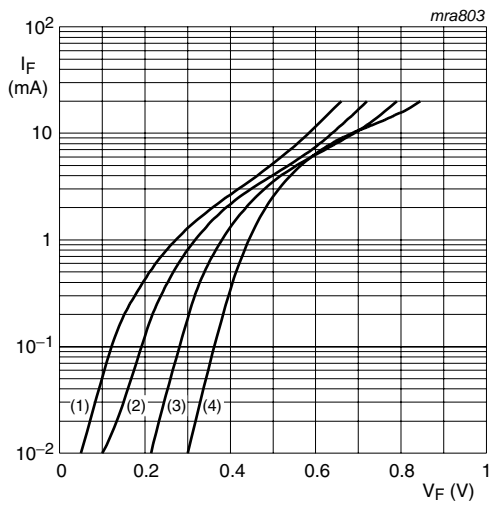
## 7. Characteristics

**Table 8. Characteristics**

$T_{amb} = 25\text{ }^{\circ}\text{C}$  unless otherwise specified.

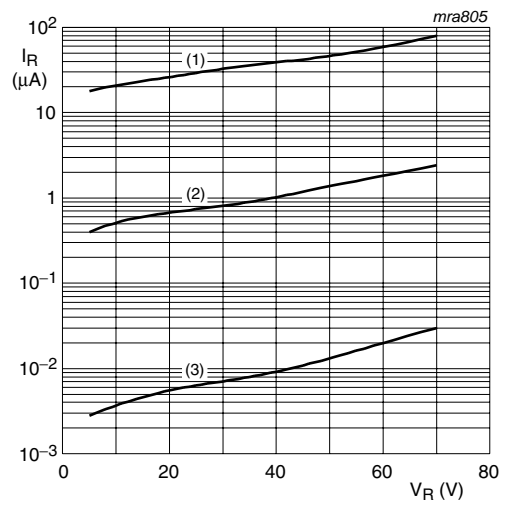
| Symbol           | Parameter         | Conditions                           | Min | Typ | Max | Unit          |
|------------------|-------------------|--------------------------------------|-----|-----|-----|---------------|
| <b>Per diode</b> |                   |                                      |     |     |     |               |
| $V_F$            | forward voltage   |                                      | [1] |     |     |               |
|                  |                   | $I_F = 1\text{ mA}$                  | -   | -   | 410 | mV            |
|                  |                   | $I_F = 10\text{ mA}$                 | -   | -   | 750 | mV            |
|                  |                   | $I_F = 15\text{ mA}$                 | -   | -   | 1   | V             |
| $I_R$            | reverse current   | $V_R = 50\text{ V}$                  | -   | -   | 100 | nA            |
|                  |                   | $V_R = 70\text{ V}$                  | -   | -   | 10  | $\mu\text{A}$ |
| $C_d$            | diode capacitance | $V_R = 0\text{ V}; f = 1\text{ MHz}$ | -   | -   | 2   | pF            |

[1] Pulse test:  $t_p \leq 300\text{ }\mu\text{s}$ ;  $\delta \leq 0.02$ .



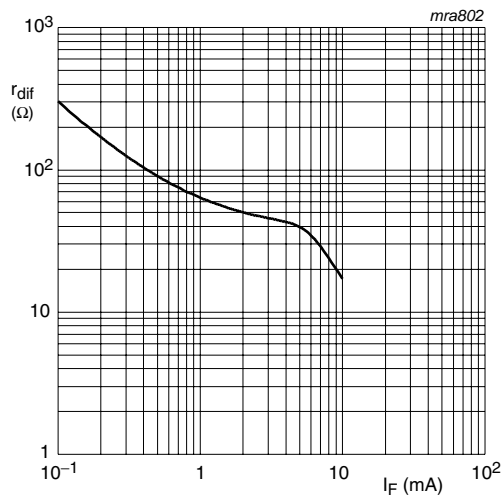
- (1)  $T_{amb} = 125\text{ °C}$
- (2)  $T_{amb} = 85\text{ °C}$
- (3)  $T_{amb} = 25\text{ °C}$
- (4)  $T_{amb} = -40\text{ °C}$

**Fig 1. Forward current as a function of forward voltage; typical values**



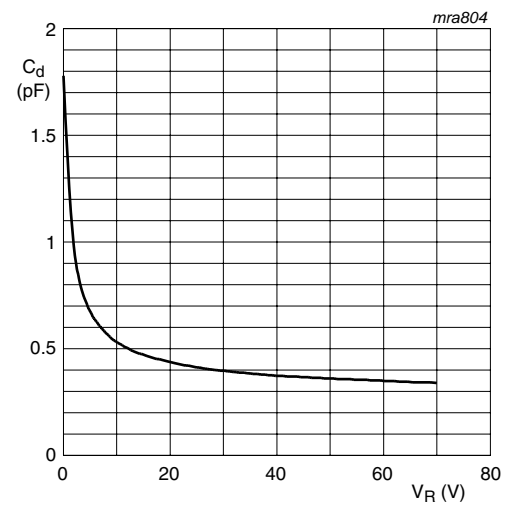
- (1)  $T_{amb} = 125\text{ °C}$
- (2)  $T_{amb} = 85\text{ °C}$
- (3)  $T_{amb} = 25\text{ °C}$

**Fig 2. Reverse current as a function of reverse voltage; typical values**



$f = 10\text{ kHz}$

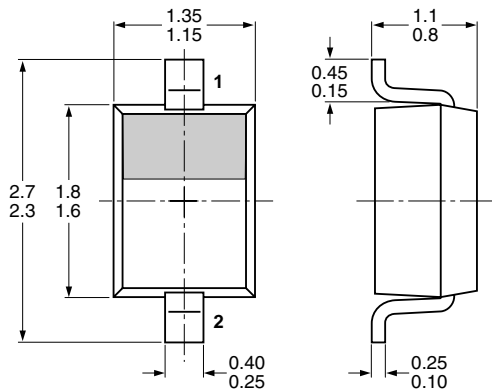
**Fig 3. Differential forward resistance as a function of forward current; typical values**



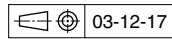
$T_{amb} = 25\text{ °C}; f = 1\text{ MHz}$

**Fig 4. Diode capacitance as a function of reverse voltage; typical values**

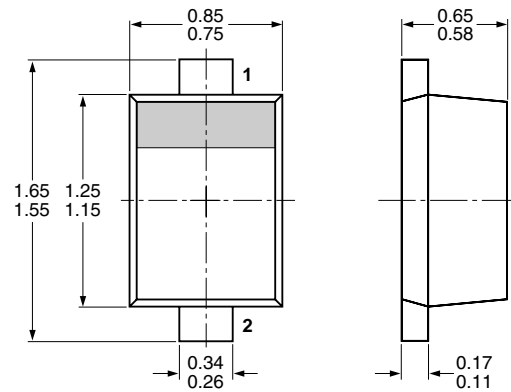
## 8. Package outline



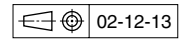
Dimensions in mm



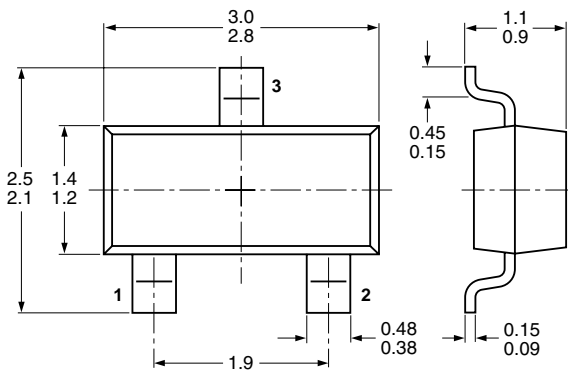
**Fig 5. Package outline SOD323 (SC-76)**



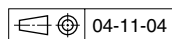
Dimensions in mm



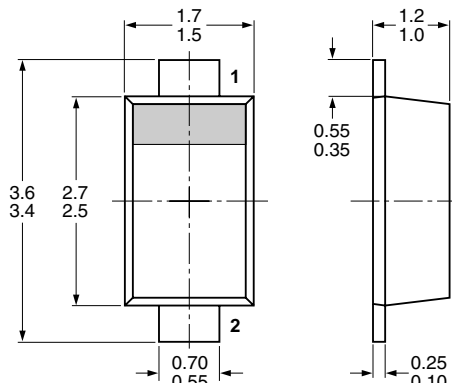
**Fig 6. Package outline SOD523 (SC-79)**



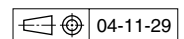
Dimensions in mm



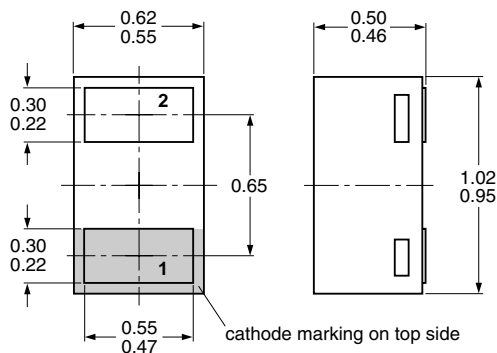
**Fig 7. Package outline SOT23 (TO-236AB)**



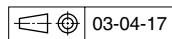
Dimensions in mm



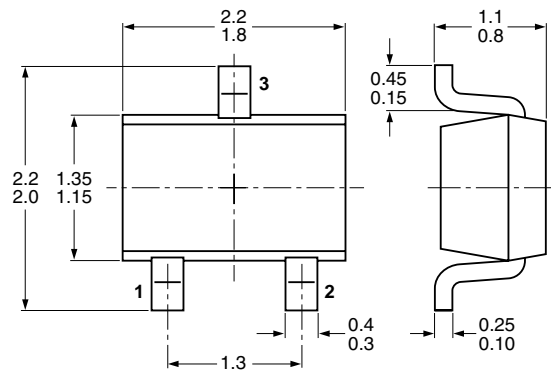
**Fig 8. Package outline SOD123F**



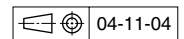
Dimensions in mm



**Fig 9. Package outline SOD882**



Dimensions in mm



**Fig 10. Package outline SOT323 (SC-70)**



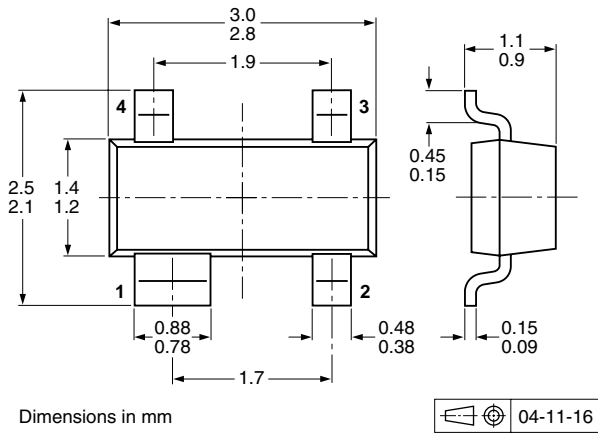


Fig 11. Package outline SOT143B

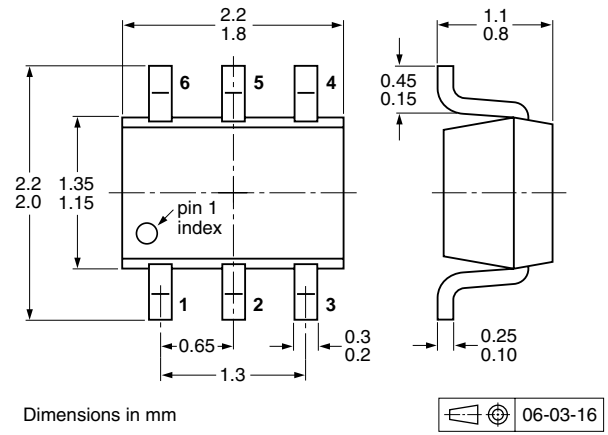


Fig 12. Package outline SOT363 (SC-88)

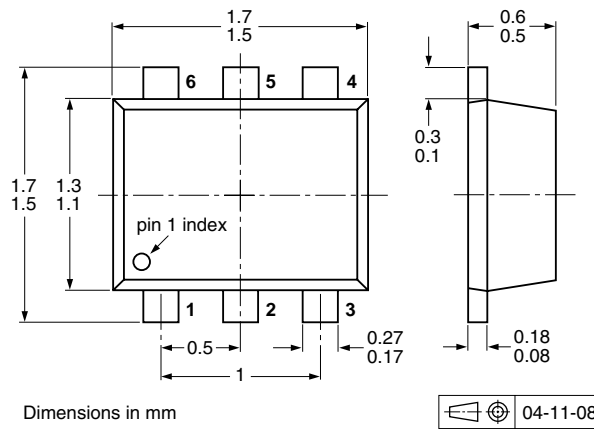


Fig 13. Package outline SOT666

## 9. Packing information

**Table 9. Packing methods**

The indicated -xxx are the last three digits of the 12NC ordering code.<sup>[1]</sup>

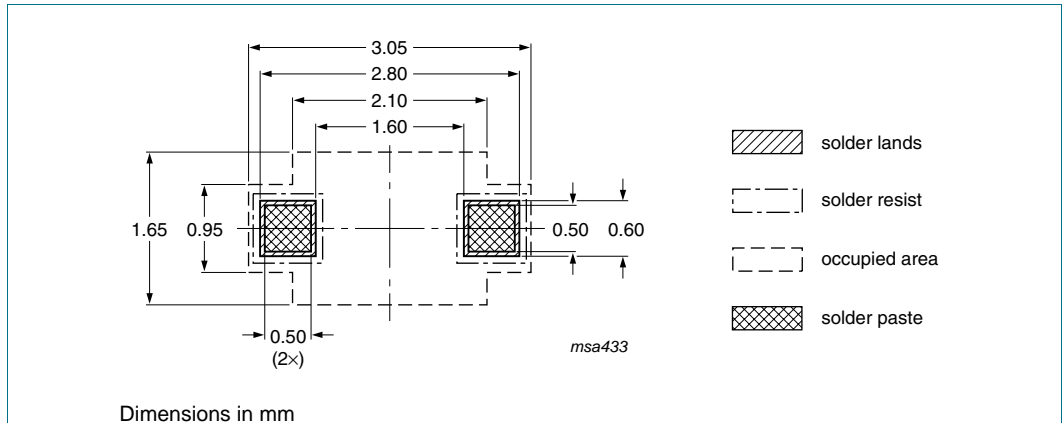
| Type number | Package | Description                                       | Packing quantity |      |      |       |
|-------------|---------|---|------------------|------|------|-------|
|             |         |   | 3000             | 4000 | 8000 | 10000 |
| 1PS76SB70   | SOD323  | 4 mm pitch, 8 mm tape and reel                    | -115             | -    | -    | -135  |
| 1PS79SB70   | SOD523  | 2 mm pitch, 8 mm tape and reel                    | -                | -    | -315 | -     |
|             |         | 4 mm pitch, 8 mm tape and reel                    | -115             | -    | -    | -135  |
| BAS70       | SOT23   | 4 mm pitch, 8 mm tape and reel                    | -215             | -    | -    | -235  |
| BAS70H      | SOD123F | 4 mm pitch, 8 mm tape and reel                    | -115             | -    | -    | -135  |
| BAS70L      | SOD882  | 2 mm pitch, 8 mm tape and reel                    | -                | -    | -    | -315  |
| BAS70W      | SOT323  | 4 mm pitch, 8 mm tape and reel                    | -115             | -    | -    | -135  |
| BAS70-04    | SOT23   | 4 mm pitch, 8 mm tape and reel                    | -215             | -    | -    | -235  |
| BAS70-04W   | SOT323  | 4 mm pitch, 8 mm tape and reel                    | -115             | -    | -    | -135  |
| BAS70-05    | SOT23   | 4 mm pitch, 8 mm tape and reel                    | -215             | -    | -    | -235  |
| BAS70-05W   | SOT323  | 4 mm pitch, 8 mm tape and reel                    | -115             | -    | -    | -135  |
| BAS70-06    | SOT23   | 4 mm pitch, 8 mm tape and reel                    | -215             | -    | -    | -235  |
| BAS70-06W   | SOT323  | 4 mm pitch, 8 mm tape and reel                    | -115             | -    | -    | -135  |
| BAS70-07    | SOT143B | 4 mm pitch, 8 mm tape and reel                    | -215             | -    | -    | -235  |
| BAS70-07S   | SOT363  | 4 mm pitch, 8 mm tape and reel; T1 <sup>[2]</sup> | -115             | -    | -    | -135  |
|             |         | 4 mm pitch, 8 mm tape and reel; T2 <sup>[3]</sup> | -125             | -    | -    | -165  |
| BAS70-07V   | SOT666  | 2 mm pitch, 8 mm tape and reel                    | -                | -    | -315 | -     |
|             |         | 4 mm pitch, 8 mm tape and reel                    | -                | -115 | -    | -     |
| BAS70VV     | SOT666  | 2 mm pitch, 8 mm tape and reel                    | -                | -    | -315 | -     |
|             |         | 4 mm pitch, 8 mm tape and reel                    | -                | -115 | -    | -     |
| BAS70XY     | SOT363  | 4 mm pitch, 8 mm tape and reel; T1 <sup>[2]</sup> | -115             | -    | -    | -135  |
|             |         | 4 mm pitch, 8 mm tape and reel; T2 <sup>[3]</sup> | -125             | -    | -    | -165  |

[1] For further information and the availability of packing methods, see [Section 13](#).

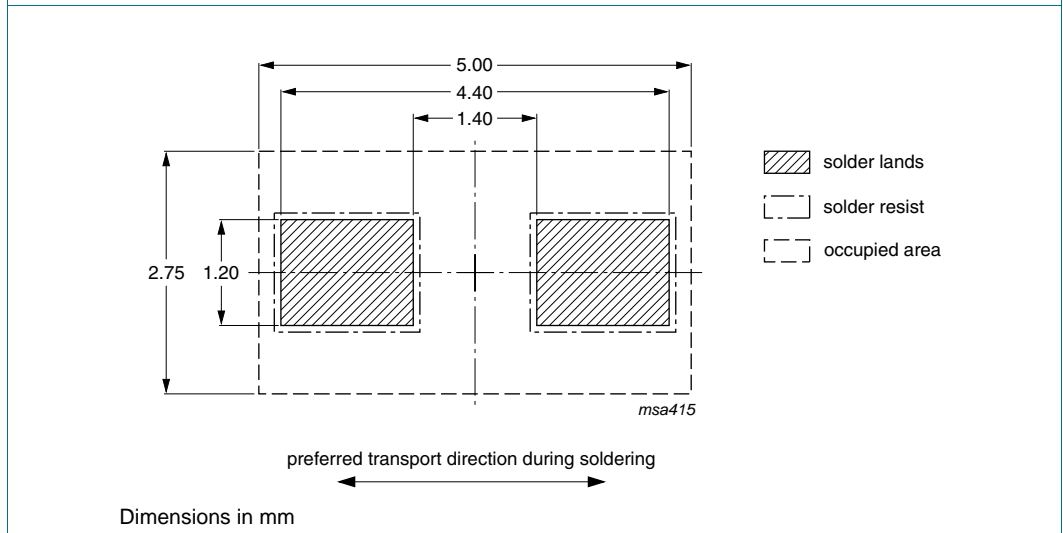
[2] T1: normal taping

[3] T2: reverse taping

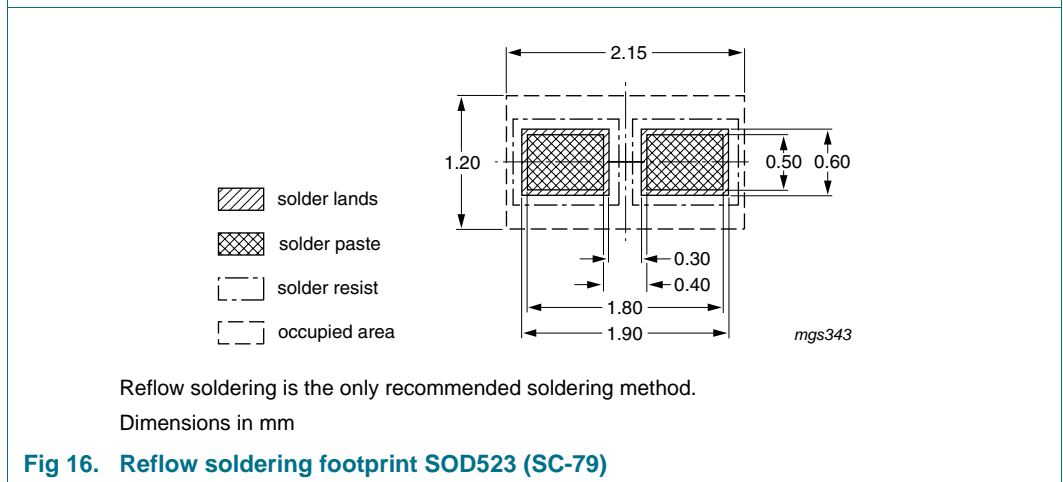
## 10. Soldering



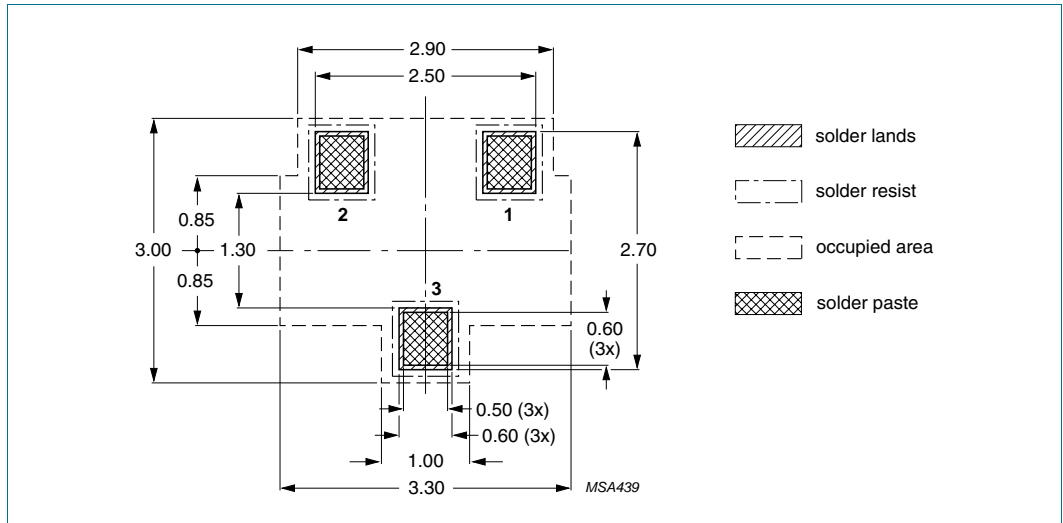
**Fig 14. Reflow soldering footprint SOD323 (SC-76)**



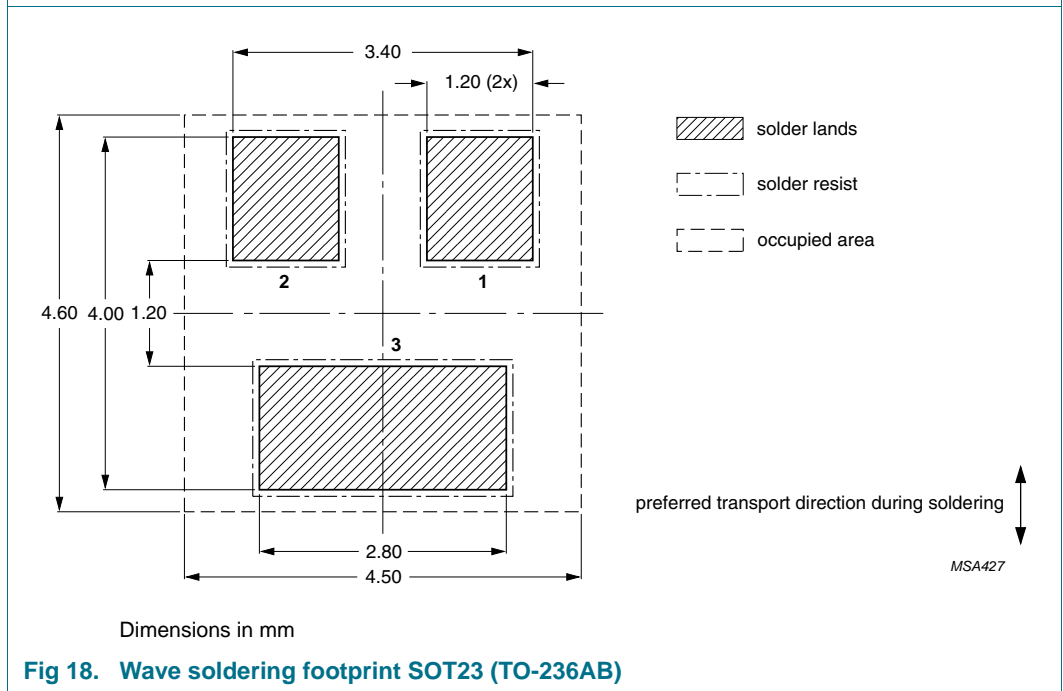
**Fig 15. Wave soldering footprint SOD323 (SC-76)**



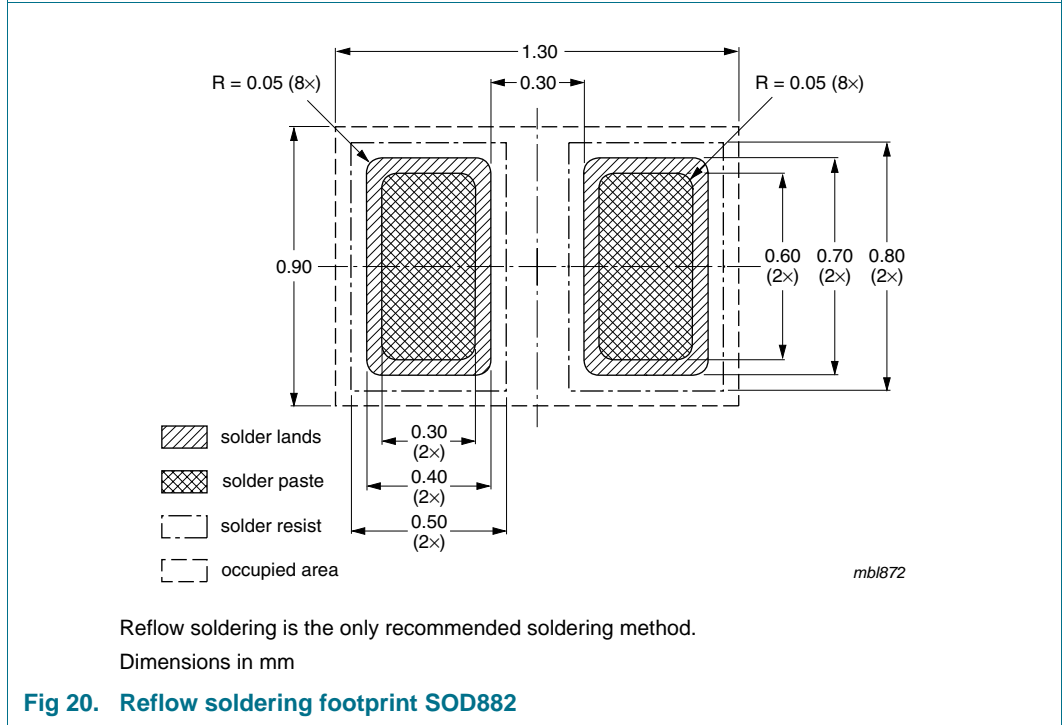
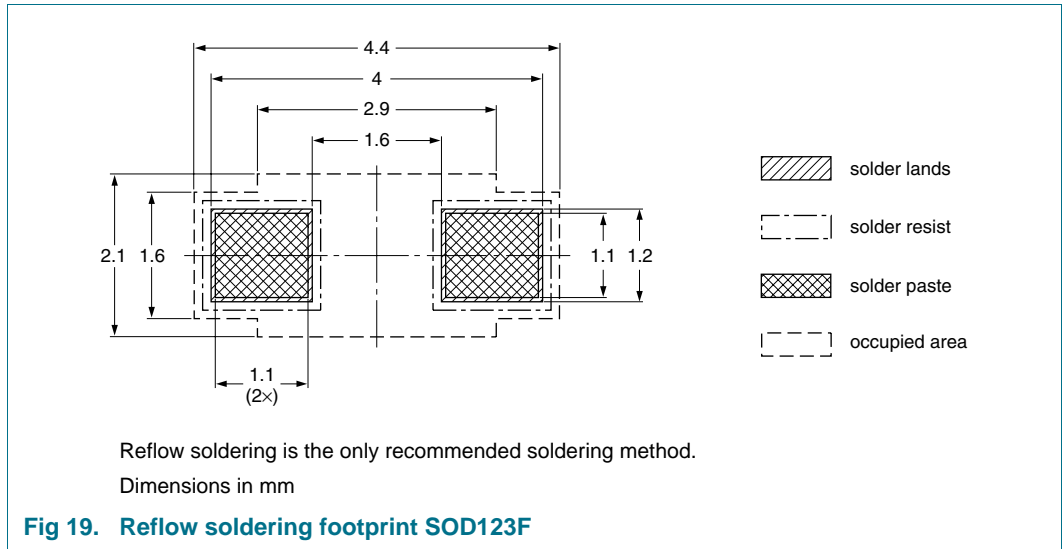
**Fig 16. Reflow soldering footprint SOD523 (SC-79)**

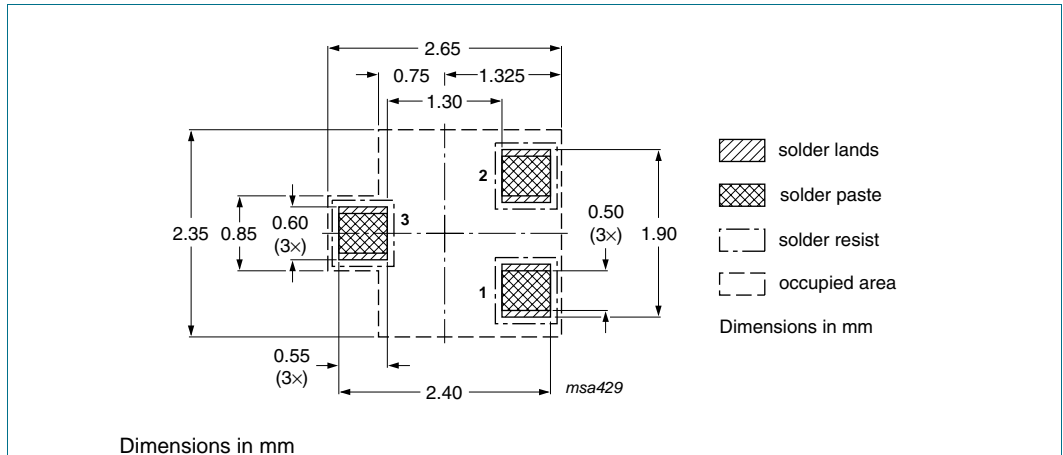


**Fig 17. Reflow soldering footprint SOT23 (TO-236AB)**

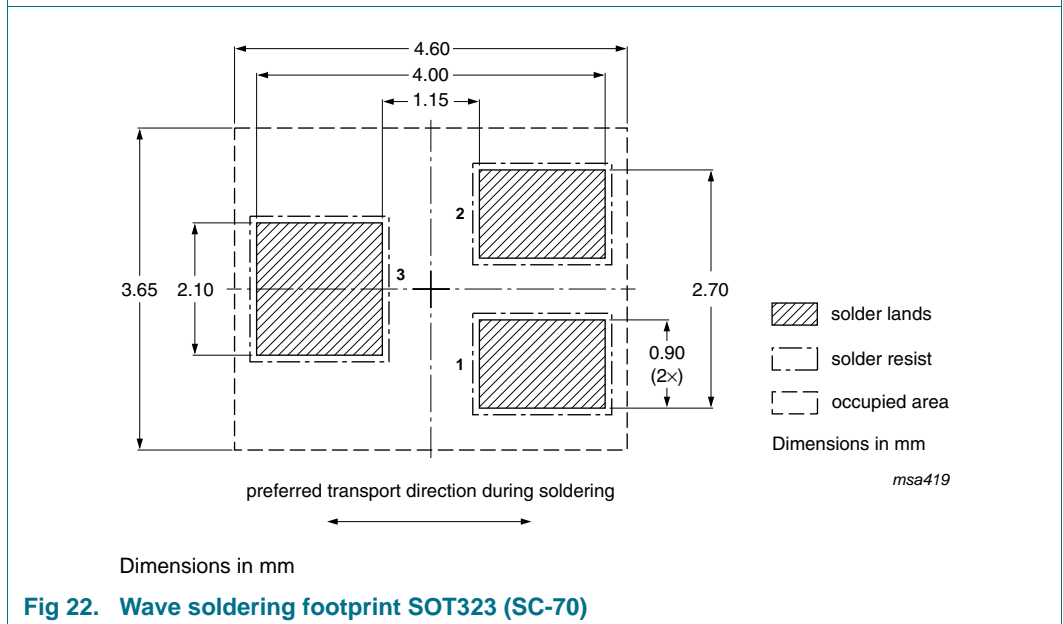


**Fig 18. Wave soldering footprint SOT23 (TO-236AB)**

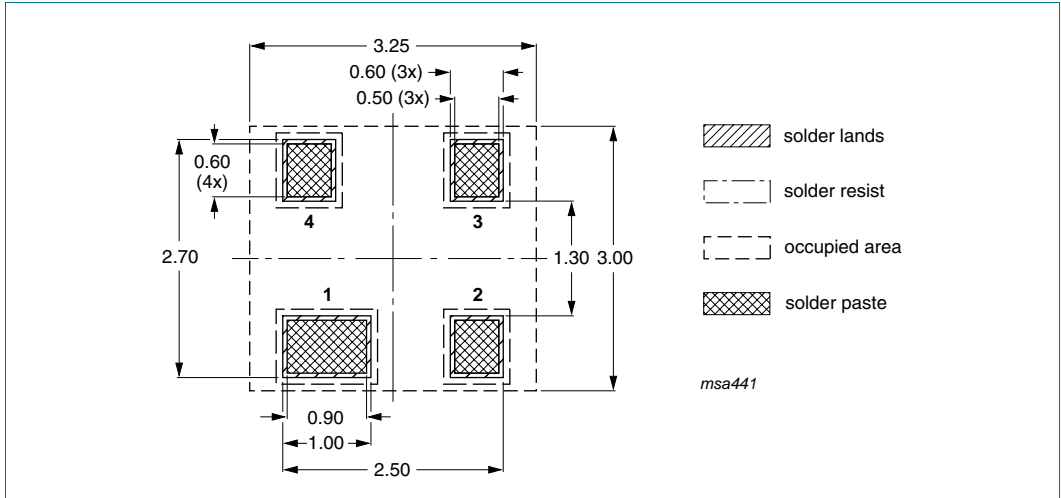




**Fig 21. Reflow soldering footprint SOT323 (SC-70)**

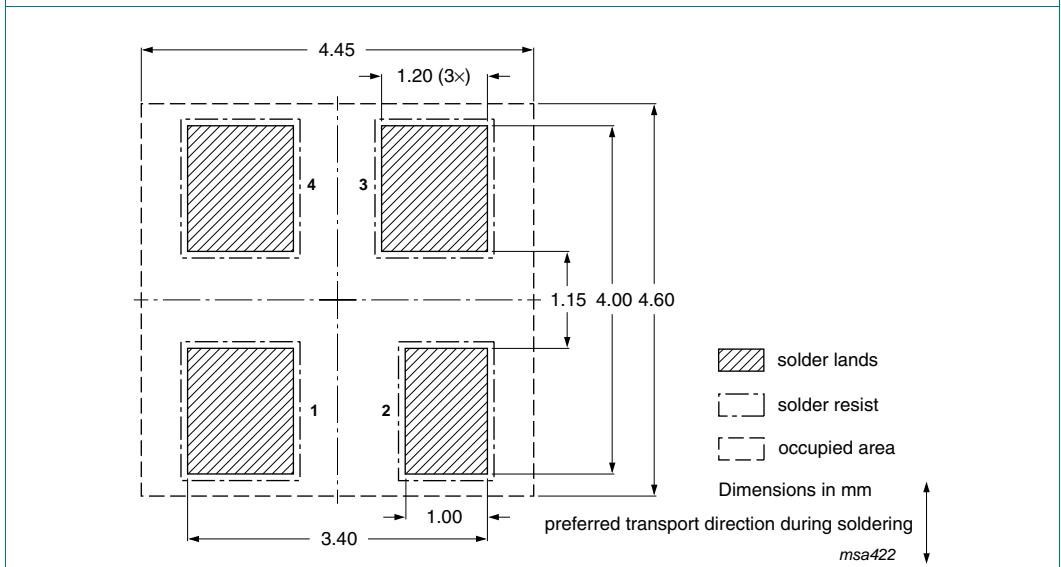


**Fig 22. Wave soldering footprint SOT323 (SC-70)**



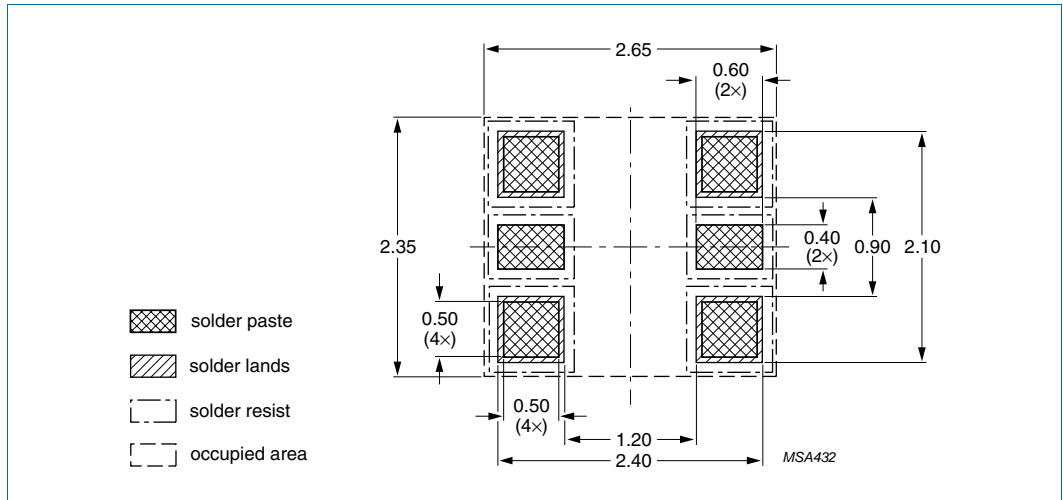
Dimensions in mm

**Fig 23. Reflow soldering footprint SOT143B**



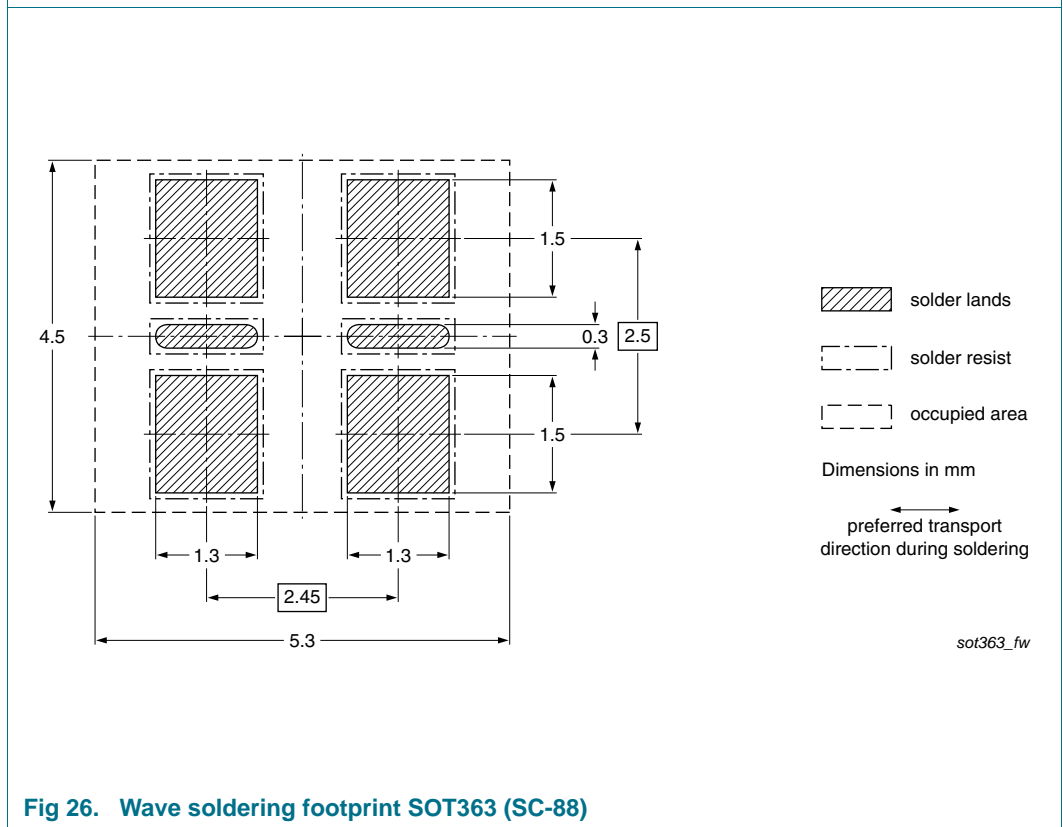
Dimensions in mm

**Fig 24. Wave soldering footprint SOT143B**



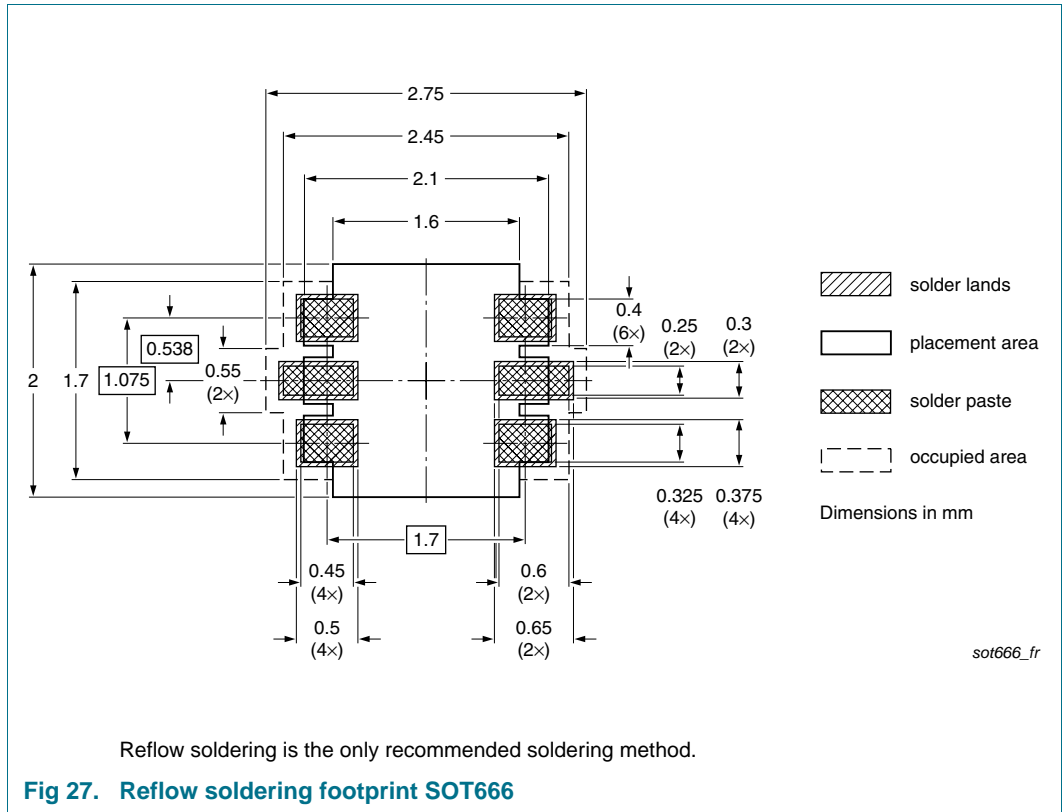
Dimensions in mm

**Fig 25. Reflow soldering footprint SOT363 (SC-88)**



**Fig 26. Wave soldering footprint SOT363 (SC-88)**





## 11. Revision history

**Table 10. Revision history**

| Document ID           | Release date  | Data sheet status     | Change notice | Supersedes   |
|-----------------------|---|-----------------------|---------------|--|
| BAS70_1PS7XSB70_SER_9 | 20100113  | Product data sheet    | -             | BAS70_1PS7XSB70_SER_8  |
| Modifications:        | <ul style="list-style-type: none"> <li>This data sheet was changed to reflect the new company name NXP Semiconductors, including new legal definitions and disclaimers. No changes were made to the technical content.</li> </ul> |                       |               |  |
| BAS70_1PS7XSB70_SER_8 | 20060504  | Product data sheet    | -             | BAS70_1PS7XSB70_SER_7  |
| BAS70_1PS7XSB70_SER_7 | 20050718  | Product data sheet    | -             | 1PS76SB70_2<br>1PS79SB70_1 BAS70H_1<br>BAS70L_1 BAS70-07V_1<br>BAS70VV_1 BAS70W_3<br>BAS70-07S_4<br>BAS70_SERIES_6 |
| 1PS76SB70_2           | 20040126  | Product specification | -             | 1PS76SB70_1  |
| 1PS79SB70_1           | 19980716  | Product specification | -             | -  |
| BAS70H_1              | 20050425  | Product data sheet    | -             | -  |
| BAS70L_1              | 20030520  | Product specification | -             | -  |
| BAS70-07V_1           | 20020117  | Product specification | -             | -  |
| BAS70VV_1             | 20040910  | Product data sheet    | -             | -  |
| BAS70W_3              | 19990326  | Product specification | -             | BAS70W_2   |
| BAS70-07S_4           | 20030411  | Product specification | -             | BAS70_07S_3  |
| BAS70_SERIES_6        | 20011011  | Product specification | -             | BAS70_5  |

## 12. Legal information

### 12.1 Data sheet status

| Document status <sup>[1][2]</sup> | Product status <sup>[3]</sup> | Definition  |
|-----------------------------------|-------------------------------|---|
| Objective [short] data sheet      | Development                   | This document contains data from the objective specification for product development. |
| Preliminary [short] data sheet    | Qualification                 | This document contains data from the preliminary specification.                       |
| Product [short] data sheet        | Production                    | This document contains the product specification.                                     |

[1] Please consult the most recently issued document before initiating or completing a design.

[2] The term 'short data sheet' is explained in section "Definitions".

[3] The product status of device(s) described in this document may have changed since this document was published and may differ in case of multiple devices. The latest product status information is available on the Internet at URL <http://www.nxp.com>.

### 12.2 Definitions

**Draft** — The document is a draft version only. The content is still under internal review and subject to formal approval, which may result in modifications or additions. NXP Semiconductors does not give any representations or warranties as to the accuracy or completeness of information included herein and shall have no liability for the consequences of use of such information.

**Short data sheet** — A short data sheet is an extract from a full data sheet with the same product type number(s) and title. A short data sheet is intended for quick reference only and should not be relied upon to contain detailed and full information. For detailed and full information see the relevant full data sheet, which is available on request via the local NXP Semiconductors sales office. In case of any inconsistency or conflict with the short data sheet, the full data sheet shall prevail.

### 12.3 Disclaimers

**General** — Information in this document is believed to be accurate and reliable. However, NXP Semiconductors does not give any representations or warranties, expressed or implied, as to the accuracy or completeness of such information and shall have no liability for the consequences of use of such information.

**Right to make changes** — NXP Semiconductors reserves the right to make changes to information published in this document, including without limitation specifications and product descriptions, at any time and without notice. This document supersedes and replaces all information supplied prior to the publication hereof.

**Suitability for use** — NXP Semiconductors products are not designed, authorized or warranted to be suitable for use in medical, military, aircraft, space or life support equipment, nor in applications where failure or malfunction of an NXP Semiconductors product can reasonably be expected to result in personal injury, death or severe property or environmental

damage. NXP Semiconductors accepts no liability for inclusion and/or use of NXP Semiconductors products in such equipment or applications and therefore such inclusion and/or use is at the customer's own risk.

**Applications** — Applications that are described herein for any of these products are for illustrative purposes only. NXP Semiconductors makes no representation or warranty that such applications will be suitable for the specified use without further testing or modification.

**Limiting values** — Stress above one or more limiting values (as defined in the Absolute Maximum Ratings System of IEC 60134) may cause permanent damage to the device. Limiting values are stress ratings only and operation of the device at these or any other conditions above those given in the Characteristics sections of this document is not implied. Exposure to limiting values for extended periods may affect device reliability.

**Terms and conditions of sale** — NXP Semiconductors products are sold subject to the general terms and conditions of commercial sale, as published at <http://www.nxp.com/profile/terms>, including those pertaining to warranty, intellectual property rights infringement and limitation of liability, unless explicitly otherwise agreed to in writing by NXP Semiconductors. In case of any inconsistency or conflict between information in this document and such terms and conditions, the latter will prevail.

**No offer to sell or license** — Nothing in this document may be interpreted or construed as an offer to sell products that is open for acceptance or the grant, conveyance or implication of any license under any copyrights, patents or other industrial or intellectual property rights.

**Export control** — This document as well as the item(s) described herein may be subject to export control regulations. Export might require a prior authorization from national authorities.

**Quick reference data** — The Quick reference data is an extract of the product data given in the Limiting values and Characteristics sections of this document, and as such is not complete, exhaustive or legally binding.

### 12.4 Trademarks

Notice: All referenced brands, product names, service names and trademarks are the property of their respective owners.

## 13. Contact information

For more information, please visit: <http://www.nxp.com>

For sales office addresses, please send an email to: [salesaddresses@nxp.com](mailto:salesaddresses@nxp.com)

## 14. Contents

|           |                                      |           |
|-----------|--------------------------------------|-----------|
| <b>1</b>  | <b>Product profile</b> .....         | <b>1</b>  |
| 1.1       | General description .....            | 1         |
| 1.2       | Features .....                       | 1         |
| 1.3       | Applications .....                   | 1         |
| 1.4       | Quick reference data .....           | 2         |
| <b>2</b>  | <b>Pinning information</b> .....     | <b>2</b>  |
| <b>3</b>  | <b>Ordering information</b> .....    | <b>4</b>  |
| <b>4</b>  | <b>Marking</b> .....                 | <b>5</b>  |
| <b>5</b>  | <b>Limiting values</b> .....         | <b>5</b>  |
| <b>6</b>  | <b>Thermal characteristics</b> ..... | <b>6</b>  |
| <b>7</b>  | <b>Characteristics</b> .....         | <b>6</b>  |
| <b>8</b>  | <b>Package outline</b> .....         | <b>8</b>  |
| <b>9</b>  | <b>Packing information</b> .....     | <b>10</b> |
| <b>10</b> | <b>Soldering</b> .....               | <b>11</b> |
| <b>11</b> | <b>Revision history</b> .....        | <b>18</b> |
| <b>12</b> | <b>Legal information</b> .....       | <b>19</b> |
| 12.1      | Data sheet status .....              | 19        |
| 12.2      | Definitions .....                    | 19        |
| 12.3      | Disclaimers .....                    | 19        |
| 12.4      | Trademarks .....                     | 19        |
| <b>13</b> | <b>Contact information</b> .....     | <b>19</b> |
| <b>14</b> | <b>Contents</b> .....                | <b>20</b> |

Please be aware that important notices concerning this document and the product(s) described herein, have been included in section 'Legal information'.



© NXP B.V. 2010.

All rights reserved.

For more information, please visit: <http://www.nxp.com>

For sales office addresses, please send an email to: [salesaddresses@nxp.com](mailto:salesaddresses@nxp.com)

Date of release: 13 January 2010

Document identifier: BAS70\_1PS7XSB70\_SER\_9