

## **Technical Information**

**Electrochemical Hydrogen Sulfide Gas Sensor**

### **NE-H2S series**

**(NE-H2S, NE-H2S-100, NE-H2S-200, NE-H2S-500)**

**For Industrial Application**

〒168-0072 4-10-9, Takaido-higashi, Suginami-ku, Tokyo

Nemoto & Co., Ltd. Sensor Div.

TEL. 81-3-3333-7341

FAX. 81-3-3333-7344

E-mail [sensor2@nemoto.co.jp](mailto:sensor2@nemoto.co.jp)

URL <http://www.nemoto.co.jp/>

## 1. General

Nemoto NE series sensors were developed for industrial applications, and NE-H2S, NE-H2S-100, NE-H2S-200 and NE-H2S-500 are available for detection of hydrogen sulfide. Shape and pin positions are compatible with others, especially NE-H2S-100 is quite compatible concerning also basic features. Additionally, the stability, repeatability, durability and reliability are superior to others, however the price is competitive with others. Features and applications are as follows.

## 2. Detection principle

Electrochemical sensor consists of working electrode on which oxidation takes place, counter electrode on which reduction takes place, and reference electrode which can monitor and keep the voltage at constant. Structure of electrochemical sensor NE-H2S is shown in the following figure, hydrogen sulfide gas diffuses through membrane into working electrode, and is oxidized at working electrode. Consequently generated proton at this reaction proceeds to counter electrode, and reacts with dissolved oxygen in electrolyte to water. Total reaction is in the below described. Hydrogen sulfide gas concentrations is proportional to the current that is generated by this serial reaction.

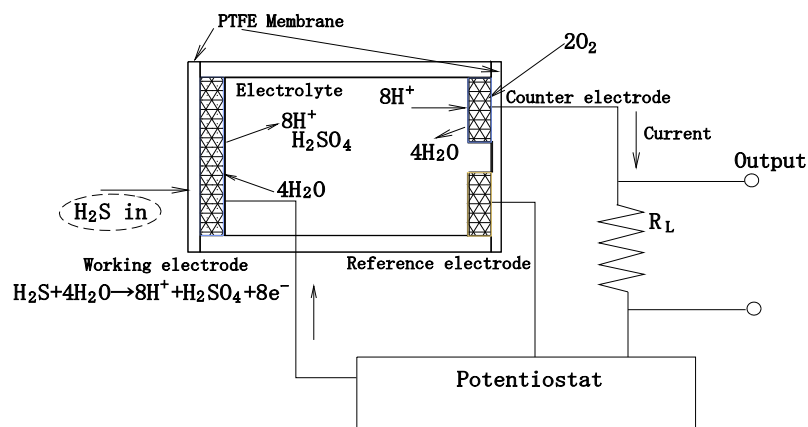

## 3. Features

- Quick response
- Excellent selectivity and repeatability
- Good linearity and stability
- High reliability and long lifetime
- Excellent durability against high temperature and humidity

## 4. Detected gas

Hydrogen sulfide

## 5. Application

- H<sub>2</sub>S gas densitometer for industrial application
- H<sub>2</sub>S gas alarm for industrial equipment
- Handheld type H<sub>2</sub>S gas leakage checker
- Environmental monitoring equipment

## 6. Dimensions and appearance

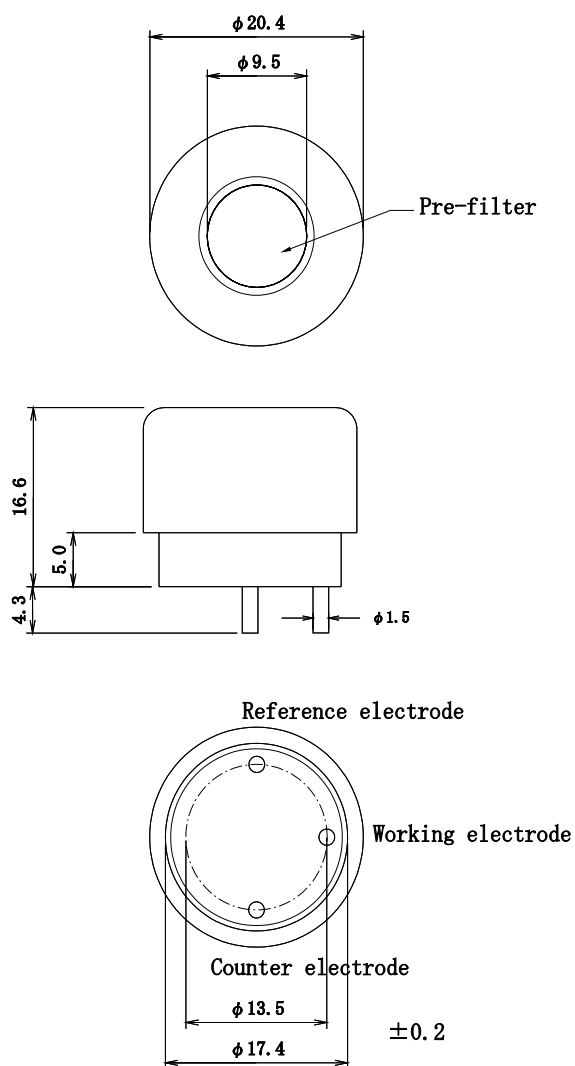

Case Material	PPO
Cap Color	Yellow
Weight	5 g (approx.)

Fig.1 Appearance and dimensions of NE-H2S  
(Other H2S series are the same as the above.)

## 7. Ratings

- |  |   |
|--|---|
| 1) Ambient temperature and humidity in operation           | Temperature : -20 - +50 degree C<br>Humidity : 15 - 90%RH |
| 2) Recommended ambient temperature and humidity in storage | Temperature : 0 - 20 degree C<br>Humidity : 15 - 90%RH    |
| 3) Operating pressure range                                | 0.9 - 1.1 atm   |

4) Detection range

Model	Detection range	Maximum overload
NE-H2S	0 – 100ppm	500ppm
NE-H2S-100	0 – 100ppm	500ppm
NE-H2S-200	0 – 200ppm	1,000ppm
NE-H2S-500	0 – 500ppm	2,000ppm

5) Recommended load resistor 10 ohm

8. Specifications

- 1) Output signal (at 20 degree C)
 

NE-H2S	500 +/- 100nA/ppm.H2S
NE-H2S-100(Standard type)	700 +/- 150nA/ppm.H2S
NE-H2S-200	500 +/- 100nA/ppm.H2S
NE-H2S-500	200 +/- 50nA/ppm.H2S
- 2) Response time (T90) Less than 30sec.
- 3) Repeatability in the same day Less than +/- 2%
- 4) Annual zero offset drift
 

NE-H2S, 100 and 200	Less than 1ppm of hydrogen sulfide
NE-H2S-500	Less than 2ppm of hydrogen sulfide
- 5) Zero offset temperature dependence
 

NE-H2S, 100 and 200	Less than 1ppm of hydrogen sulfide
NE-H2S-500	Less than 3ppm of hydrogen sulfide
- 6) Sensitivity reduction in long term Less than 10%/year
- 7) Lifetime warranty 24 months
- 8) Recommended storage time Less than 6 months

9. Electrical properties

9-1. Typical Gas Sensitivity

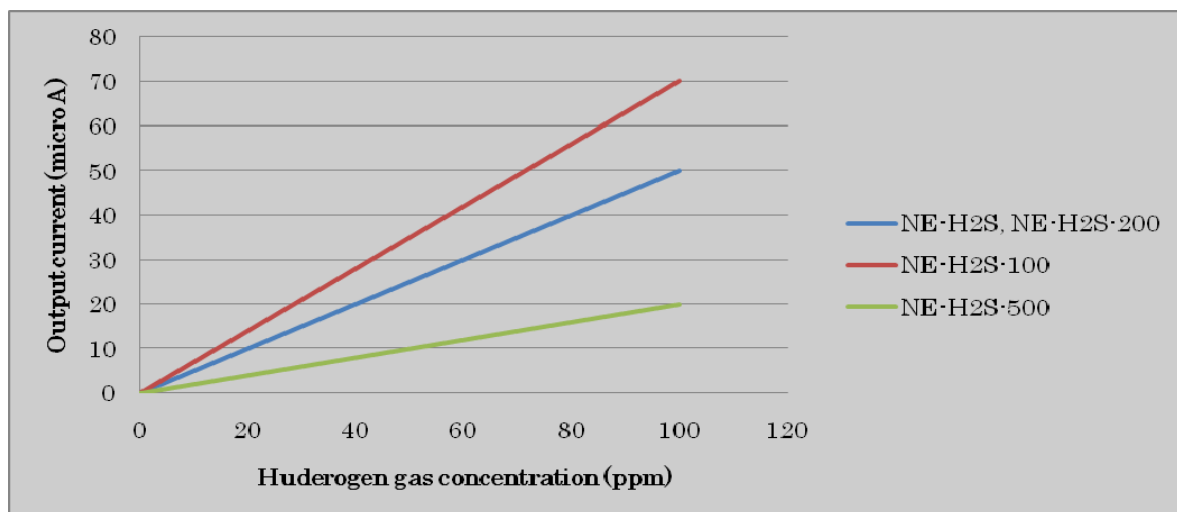

Fig.2 : Gas Sensitivity of NE-H2S series

## 9-2. Cross Sensitivity

Table 1 : Cross Sensitivity of NE-H2S series

Detected gases	Relative sensitivity (Sensitivity to H2S is 100.)		
	NE-H2S, NE-H2S-200	NE-H2S-100	NE-H2S-500
Hydrogen sulfide	100	100	100
Carbon monoxide	Less than 2	Less than 3	Less than 5
Carbon dioxide	0	0	0
Hydrogen	Less than 1	Less than 1	Less than 2
Chlorine	0	0	0
Sulfur-dioxide	Less than 13	Less than 20	Less than 23
Nitric oxide	Less than 5	Less than 4	Less than 3
Methane	0	0	0
Ammonia	0	0	0
Nitrogen dioxide	-20	-30	-30
Ethylene	Approx. 0	Approx. 0	Approx. 0

\*Exposure time : 30min.

## 9-3. Temperature dependence

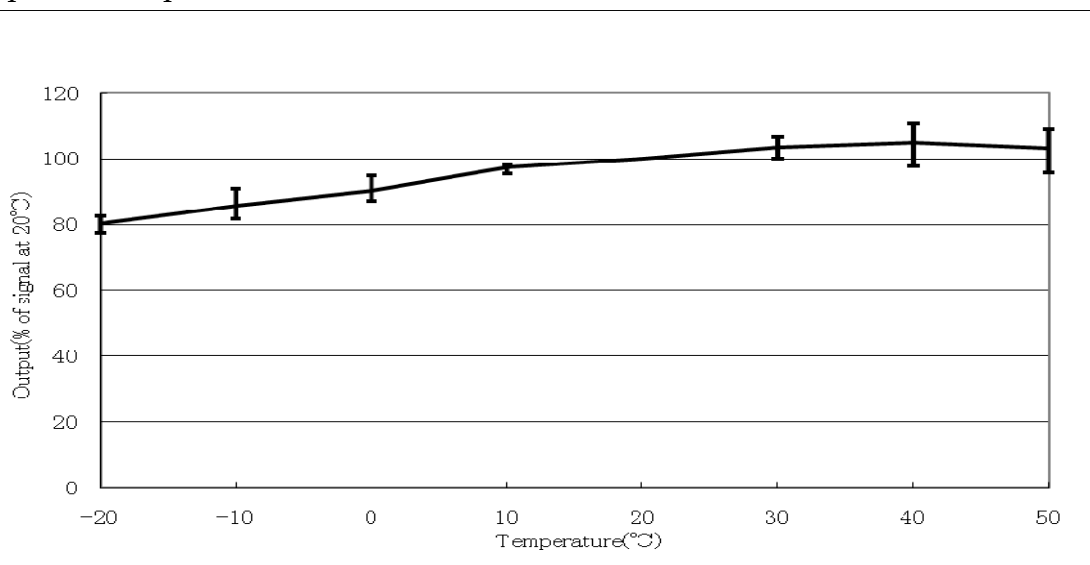

Fig. 3 : Typical temperature coefficient of NE-H2S  
(100 at 20 degree C)

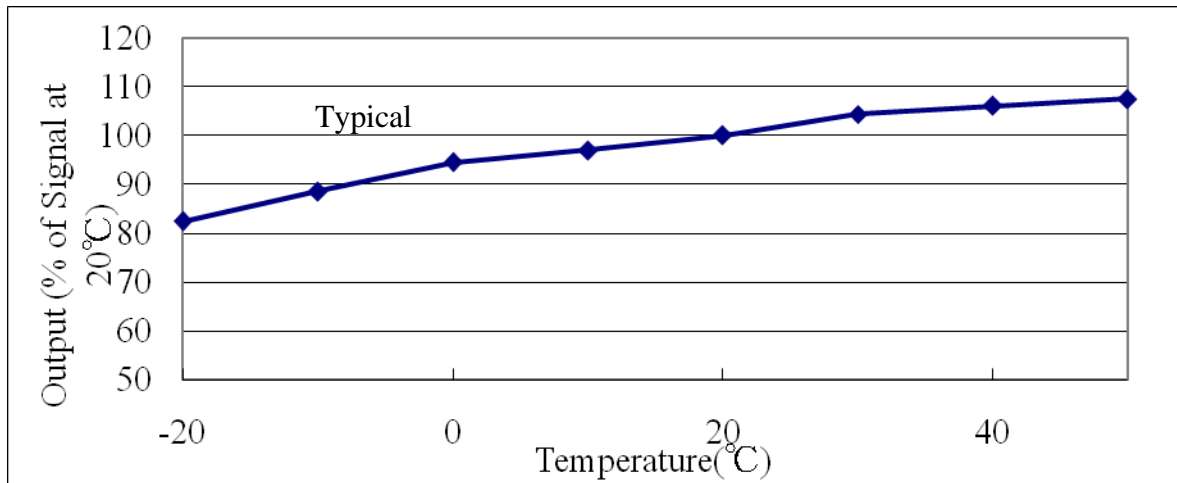

Fig. 4 : Temperature dependence of NE-H2S-100, NE-H2S-200

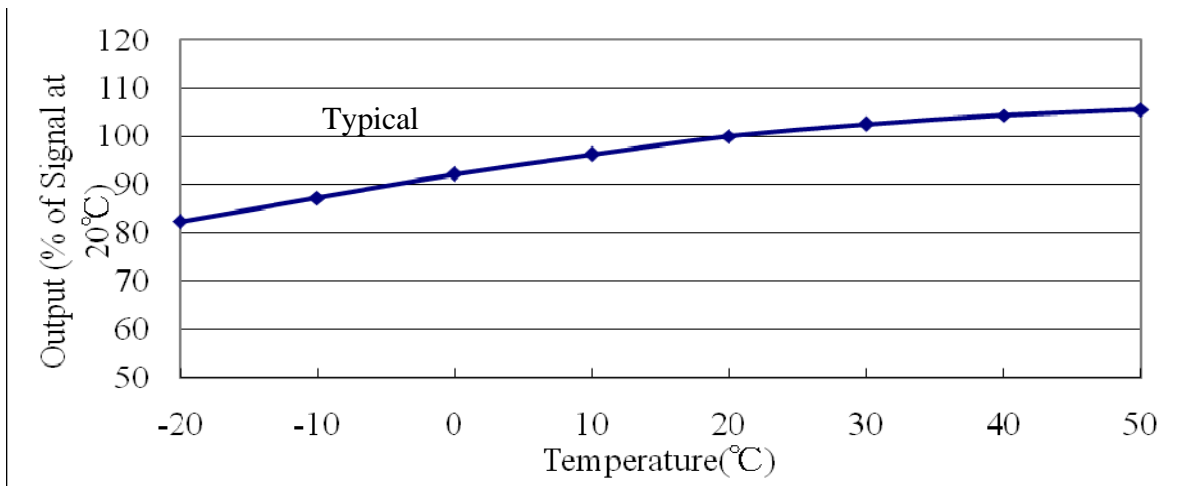

Fig. 5 : Temperature dependence of NE-H2S-500

#### 9-4. Response and recovery characteristics

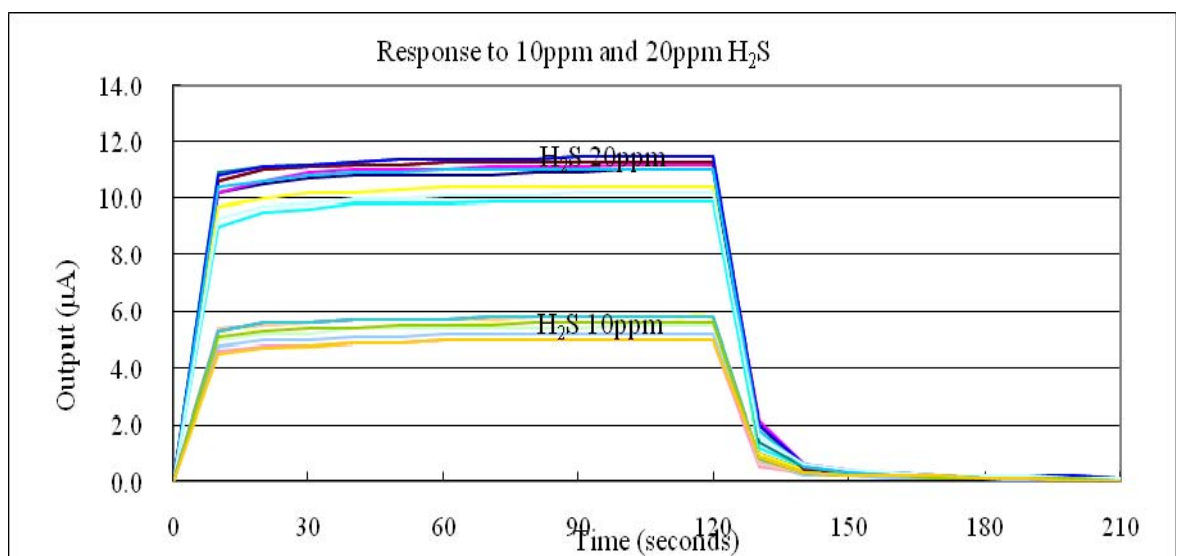

Fig.6 : Response and recovery characteristics of NE-H2S (at 20 degree C)

### 9-6. Long term stability

It is quite stable in normal circumstance for over 3 years.

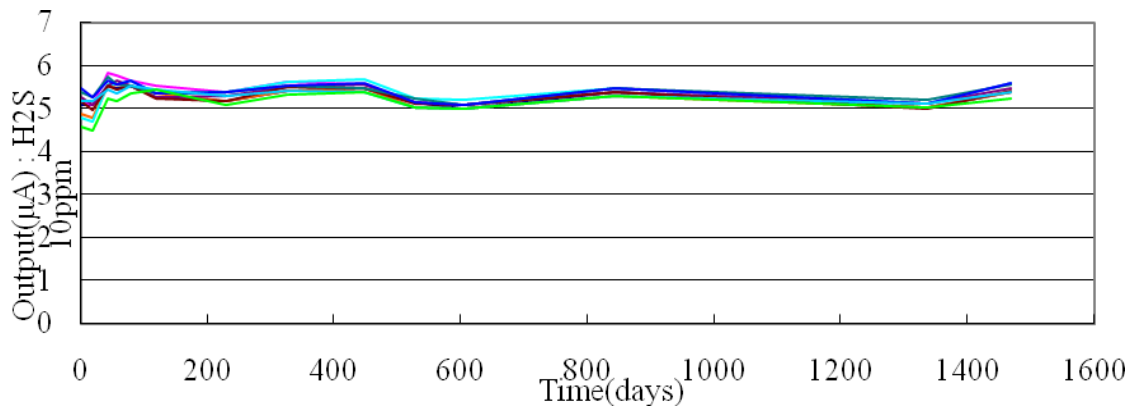

Fig.7 : Long term stability of NE-H2S in normal circumstance

### 10. Durability

NE-H2S is much durable in strict environment such as high temperature and high humidity, or in high temperature with dry. Features are as follows.

#### 10-1. Durability in high temperature

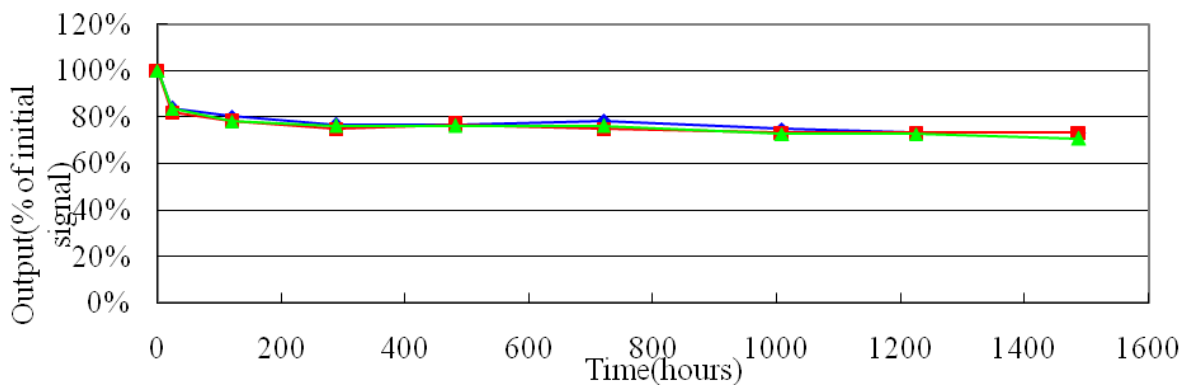

Fig. 8 : Durability in high temperature (80 degree C) with dry circumstance

#### 10-2. Durability in high temperature and high humidity

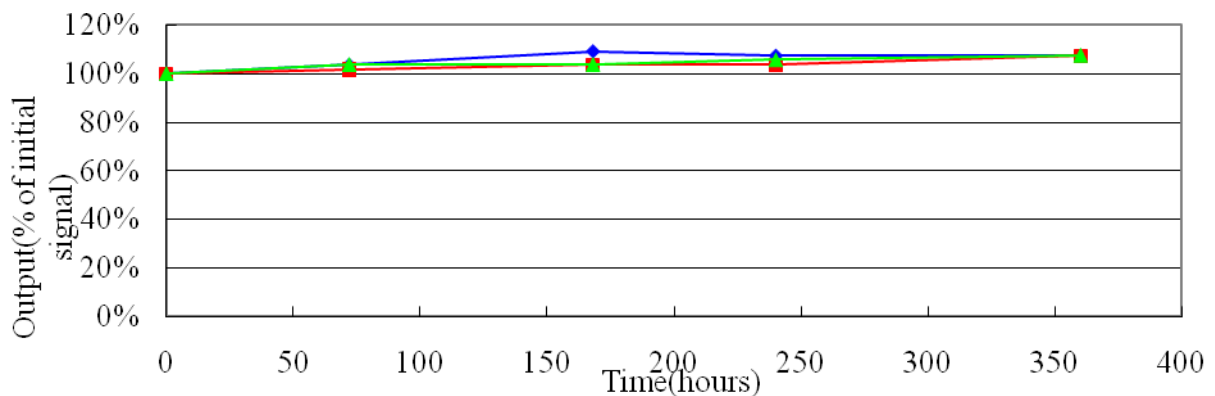

Fig. 9 : Durability in high temperature (60 degree C) and high humidity (90%RH)

### 10-3. Low temperature durability

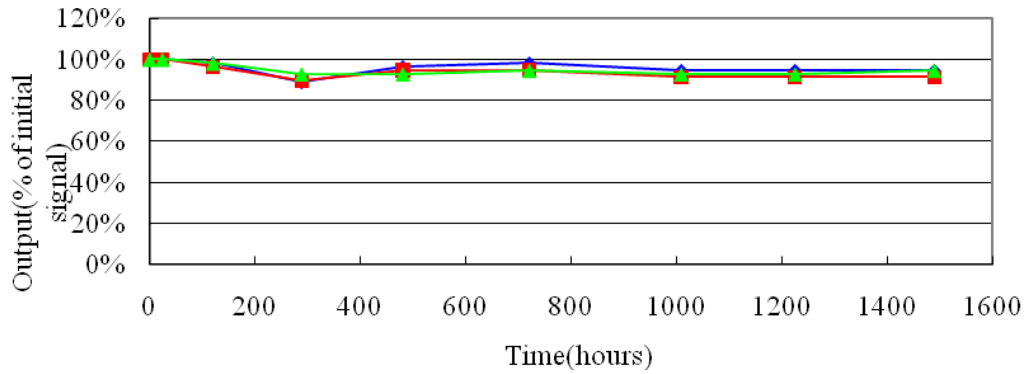

Fig.10 : Durability in low temperature (-20 degree C)

### 10-4. Thermal shock test

#### Test conditions

Sensor is stored in -20 degree C for 30min. and in +50 degree C for 30 min. respectively, and this cycle were repeated for 10 times.

Table 3. Thermal shock test

No.	Before test (micro A)		After test (micro A)		Sensitivity variation ratio (%)
	Zero offset in air	Sensitivity to 100ppm of H2S	Zero offset in air	Sensitivity to 100ppm of H2S	
1	0.01	56.2	0.02	56.2	100.0
2	0.01	54.1	0.03	54.0	99.8
3	0.01	56.9	0.03	56.8	99.8
4	0.01	54.3	0.03	54.1	99.6
5	0.01	55.8	0.02	55.9	100.2

### 10-5. Drop test

#### Test conditions

Sensor is dropped to concrete floor from the height of 1m with free fall for 5 times.

Table 4. Drop test

No.	Before test (micro A)		After test (micro A)		Sensitivity variation ratio (%)
	Zero offset in air	Sensitivity to 100ppm of H2S	Zero offset in air	Sensitivity to 100ppm of H2S	
1	0.03	55.4	0.03	55.5	100.2
2	0.03	56.5	0.03	56.4	99.8
3	0.02	54.7	0.04	54.9	100.4



10-6. Exposure in noise gas

A. Exposure in SO<sub>2</sub> gas

Test conditions

Sensor is exposed in 50ppm of sulfur dioxide for 2hrs. at normal temperature and humidity.

Table 5. Exposure in SO<sub>2</sub>

No.	Before test (micro A)		After test (micro A)		Sensitivity variation ratio (%)
	Zero offset in air	Sensitivity to 100ppm of H <sub>2</sub> S	Zero offset in air	Sensitivity to 100ppm of H <sub>2</sub> S	
1	0.00	55.4	0.02	55.4	100.0
2	0.00	56.1	0.02	56.2	100.2
3	0.00	54.1	0.03	54.6	100.9
4	0.00	58.1	0.03	58.6	100.9
5	0.00	54.1	0.03	54.0	99.8

B. Exposure in ammonia gas

Test conditions

Sensor is exposed in 200ppm of ammonia for 2hrs. at normal temperature and humidity.

Table 6. Exposure in ammonia

No.	Before test (micro A)		After test (micro A)		Sensitivity variation ratio (%)
	Zero offset in air	Sensitivity to 100ppm of H <sub>2</sub> S	Zero offset in air	Sensitivity to 100ppm of H <sub>2</sub> S	
1	0.02	56.1	0.00	55.4	98.8
2	0.02	57.0	0.00	56.1	98.4
3	0.02	55.2	0.00	54.1	98.0
4	0.02	59.0	0.00	58.1	98.5
5	0.02	55.0	0.00	54.1	98.4

C. Exposure in NO<sub>2</sub> gas

Test conditions

Sensor is exposed in 50ppm of nitrogen dioxide for 2hrs. in normal temperature and humidity.

Table 7. Exposure in NO<sub>2</sub>

No.	Before test (micro A)		After test (micro A)		Sensitivity variation ratio (%)
	Zero offset in air	Sensitivity to 100ppm of H <sub>2</sub> S	Zero offset in air	Sensitivity to 100ppm of H <sub>2</sub> S	
1	0.00	54.8	-0.01	55.0	100.4
2	-0.01	55.8	0.01	56.5	101.3
3	0.00	53.5	0.00	54.0	100.9
4	-0.01	58.2	0.00	58.0	99.6
5	0.00	53.7	0.00	54.5	101.5

#### D. Exposure in hydrogen gas

##### Test conditions

Sensor is exposed in 500ppm of hydrogen for 10hrs. at normal temperature and humidity.

Table 8. Exposure in hydrogen

No.	Before test (micro A)		After test (micro A)		Sensitivity variation ratio (%)
	Zero offset in air	Sensitivity to 100ppm of H2S	Zero offset in air	Sensitivity to 100ppm of H2S	
1	0.03	56.3	0.02	56.1	99.6
2	0.03	57.1	0.02	57.5	100.7
3	0.02	55.3	0.02	55.1	99.6
4	0.03	58.9	0.02	59.8	101.5
5	0.03	54.8	0.02	55.0	100.4

#### E. Exposure in HMDS gas

##### Test conditions

Sensor is exposed in 200ppm of HMDS (Hexa-methyl di-siloxane) for 2hrs. at normal temperature and humidity.

Table 9. Exposure in HMDS

No.	Before test (micro A)		After test (micro A)		Sensitivity variation ratio (%)
	Zero offset in air	Sensitivity to 100ppm of H2S	Zero offset in air	Sensitivity to 100ppm of H2S	
1	-0.01	55.0	-0.01	55.0	100.0
2	0.01	56.5	0.01	56.1	99.2
3	0.00	54.0	0.00	54.2	100.4
4	0.00	58.0	0.00	58.6	101.0
5	0.00	53.4	0.00	54.2	99.5

#### 11. Recommended circuit diagram

Recommended circuit diagram for evaluation of NE-H2S is shown in figure 11. In this circuit diagram, OP97 as operational amplifier is employed, however the other low price one is to be applicable for actual use. And, thermistor is employed, resistance value of 10Kohm at 25 degree C and around 3500 as B constant is recommended. Ishizuka thermistor is not pointed, and another one is also available.

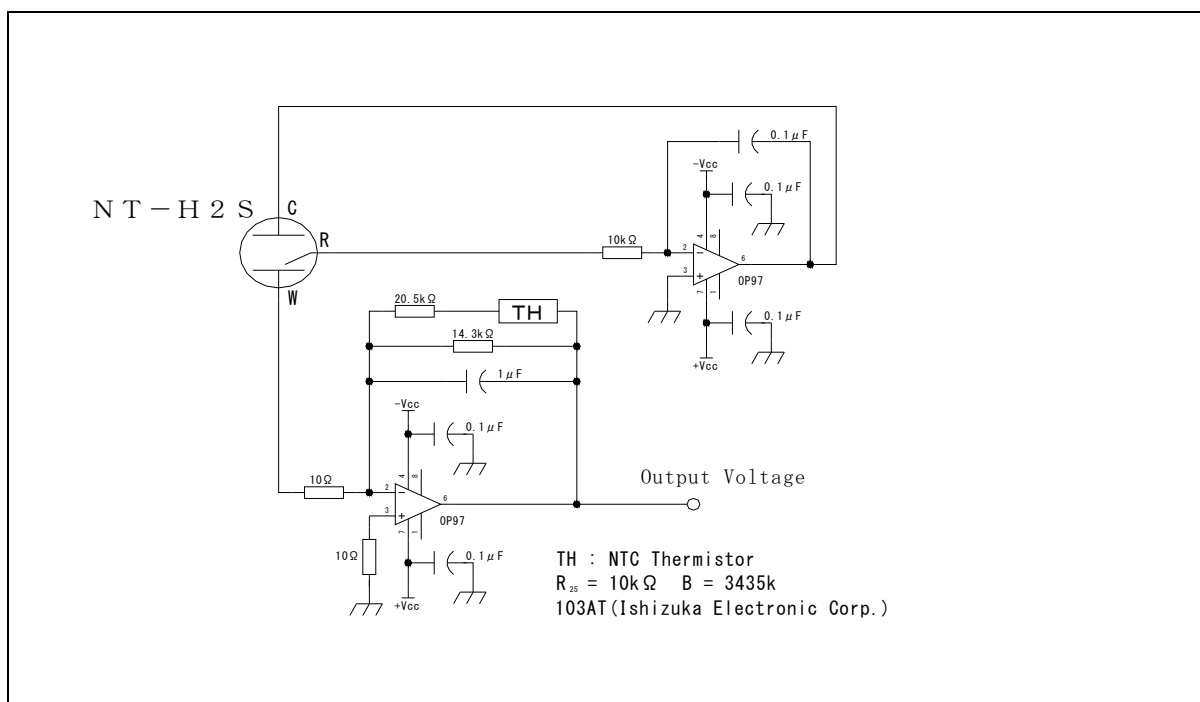

Fig. 11 Measuring circuit diagram for evaluation

## 12. Notice on handling

### 12-1. Seasonal variation of sensitivity

Highly hygroscopic electrolyte is normally employed for electrochemical sensor, and then the sensitivity varies according to change of temperature and humidity, i.e. sensitivity is little lower in low humidity than in high humidity. Since it is because of amount of electrolyte, this seasonal variation of sensitivity should be taken into account in case that precise measurement is necessary. However, this variation is reversible phenomenon.

### 12-2. Design of gas alarm or gas densitometer

- a. Calibration of gas alarm or gas densitometer is to be carried out in clean air after the output was stabilized.
- b. Gas sensitivity reduction ratio of 10% per year is to be taken into account at designing of gas alarm as recommendation. In case that precise detection is required, periodical calibration is recommended.
- c. In case that water drop or oil is on the pre-filter, accurate measurement may not be available because of low diffusion of detected gas to sensor. If such accident may be conceived, design of prevention from such one is to be considered.
- d. Warranty time is 2 years in case of being used in normal circumstance.

### 12-3. Storage of sensor

It is recommended that electrochemical sensor should be stored in normal temperature and humidity, possibly 0-20 degree C, of clean air.

Recommended storage time after delivery is less than 6 months. If the storage time is extended, the

warranty term is to be shortened. It is because the lifetime of electrochemical sensor is not dependent on being electrified or not like semi-conductive type or catalytic type, and then this matter is to be correctly comprehensive in order to keep quality.

#### 12-4. General notice

- Use only within specified conditions.
- Sensor characteristics must be measured in clean air.
- Electrode pins must be correctly connected. Wrong connection does not allow correct functions.
- Do not apply voltage directly to electrode pins.
- Do not bend pins.
- Do not put excess vibration or shocks.
- If sensor housing is damaged or scratched, do not use.
- Do not blow organic solvents, paints, chemical agents, oils, or high concentration gases directly onto sensors.
- Do not solder pins of sensor directly. Use exclusive sockets.
- Do not disassemble or change any parts.
- In case that sensor is stored by detachment from circuit board, it is recommended that working electrode pin should be short-circuited with reference electrode pin in order to shorten the initial stabilization time .
- If sensor is used under irregular atmosphere, contact us.

**NEMOTO & CO., LTD**  
**4-10-9 Takaido-Higashi Suginami-ku Tokyo 168-0072 Japan**  
**TEL 81-03-3333-7341 FAX 81-03-3333-7344**

Tech.Inf.No.NE-H2S-080601