



### Description

The 1812L Series PTC provides surface mount overcurrent protection for applications where resettable protection is desired.

### Features

- RoHS compliant, lead-free and halogen-free
- Fast response
- Compact design
- Low resistance
- Low-profile
- Compatible with high temperature solders

### Applications

- Plug and play protection for motherboards and peripherals
- USB peripherals
- PCI cards
- Game console port protection

### Agency Approvals

AGENCY AGENCY FILE NUMBER





E183209



R50119118

### Electrical Characteristics

Part Number	Marking	I <sub>hold</sub> (A)	I <sub>trip</sub> (A)	V <sub>max</sub> (Vdc)	I <sub>max</sub> (A)	P <sub>d</sub> typ. (W)	Max. Time To Trip		Resistance		Agency Approvals	
							Current (A)	Time (Sec.)	R <sub>min</sub> (Ω)	R <sub>1max</sub> (Ω)		
1812L010	LF010	0.10	0.30	30	100	0.8	0.50	1.50	1.600	15.000	X	X
1812L014	LF014	0.14	0.34	60	10	0.8	1.50	0.15	1.500	6.000	X	X
1812L020	LF020	0.20	0.40	30	100	0.8	8.00	0.02	0.800	5.000	X	X
1812L035/30	LF035-30	0.35	0.75	30	100	0.8	8.00	0.02	0.800	5.000	X	X
1812L050 <sup>1</sup>	LF050	0.50	1.00	15	100	0.8	8.00	0.15	0.150	1.000	X	X
1812L050/30	LF050-30	0.50	1.00	30	100	0.8	8.00	0.15	0.150	1.000	X	X
1812L075 <sup>1</sup>	LF075	0.75	1.50	13.2	100	0.8	8.00	0.20	0.100	0.450	X	X
1812L075/24	LF075-24	0.75	1.50	24	100	0.8	8.00	0.20	0.110	0.290	X	X
1812L075/33	LF075-33	0.75	1.50	33	20	0.8	8.00	0.20	0.110	0.400	X	X
1812L110 <sup>1</sup>	LF110	1.10	2.20	8	100	0.8	8.00	0.30	0.040	0.210	X	X
1812L110/16	LF110-16	1.10	1.95	16	100	0.8	8.00	0.30	0.060	0.180	X	X
1812L110/24	LF110-24	1.10	1.95	24	20	0.8	8.00	0.50	0.060	0.200	X	X
1812L110/33	LF110-33	1.10	1.95	33	20	0.8	8.00	0.50	0.060	0.200	X	X
1812L125/6	LF125-6	1.25	2.50	6	100	0.8	8.00	0.40	0.050	0.140	X	X
1812L125/16	LF125	1.25	2.50	16	100	0.8	8.00	0.40	0.050	0.140	X	X
1812L150 <sup>1</sup>	LF150	1.50	3.00	8	100	0.8	8.00	0.30	0.040	0.110	X	X
1812L150/12	LF150-12	1.50	3.00	12	100	0.8	8.00	0.50	0.040	0.110	X	X
1812L150/24	LF150-24	1.50	3.00	24	20	0.8	8.00	1.50	0.040	0.120	X	X
1812L160 <sup>1</sup>	LF160	1.60	2.80	8	100	0.8	8.00	1.00	0.030	0.100	X	X
1812L160/12	LF160-12	1.60	2.80	12	100	0.8	8.00	1.00	0.030	0.100	X	X
1812L200TH <sup>1</sup>	LF200	2.00	3.50	8	100	0.8	8.00	2.00	0.020	0.070	X	X
1812L260TH <sup>1</sup>	LF260	2.60	5.00	8	100	0.8	8.00	2.50	0.015	0.047	X	X
1812L260/12	LF260-12	2.60	5.00	12	100	0.8	8.00	5.00	0.015	0.055	X	X
1812L300	LF300	3.00	5.00	6	100	0.8	8.00	4.00	0.012	0.040	X	X

I<sub>hold</sub> = Hold current: maximum current device will pass without tripping in 20°C still air.  
 I<sub>trip</sub> = Trip current: minimum current at which the device will trip in 20°C still air.  
 V<sub>max</sub> = Maximum voltage device can withstand without damage at rated current (I<sub>max</sub>)  
 I<sub>max</sub> = Maximum fault current device can withstand without damage at rated voltage (V<sub>max</sub>)

P<sub>d</sub> = Power dissipated from device when in the tripped state at 20°C still air.  
 R<sub>min</sub> = Minimum resistance of device in initial (un-soldered) state.  
 R<sub>typ</sub> = Typical resistance of device in initial (un-soldered) state.  
 R<sub>1max</sub> = Maximum resistance of device at 20°C measured one hour after tripping or reflow soldering of 260°C for 20 sec.

**Caution:** Operation beyond the specified rating may result in damage and possible arcing and flame.

<sup>1</sup> Some older references to these devices may include “-C” in the Part Number. The “-C” should be omitted when placing new orders for the device.

### Temperature Derating

Part Number	Ambient Operation Temperature								
	-40°C	-20°C	0°C	23°C	40°C	50°C	60°C	70°C	85°C
	Hold Current (A)								
1812L010	0.16	0.14	0.12	0.10	0.08	0.07	0.06	0.05	0.03
1812L014	0.23	0.19	0.17	0.14	0.12	0.10	0.09	0.08	0.06
1812L020	0.29	0.26	0.23	0.20	0.17	0.15	0.14	0.12	0.10
1812L035/30	0.50	0.45	0.40	0.35	0.30	0.26	0.24	0.20	0.16
1812L050	0.77	0.68	0.59	0.50	0.44	0.40	0.37	0.33	0.29
1812L050/30	0.77	0.68	0.59	0.50	0.44	0.40	0.37	0.33	0.29
1812L075	1.15	1.01	0.88	0.75	0.65	0.60	0.55	0.49	0.43
1812L075/24	1.06	0.95	0.84	0.75	0.60	0.55	0.50	0.45	0.37
1812L075/33	1.10	1.00	0.88	0.75	0.66	0.60	0.56	0.47	0.36
1812L110	1.59	1.43	1.26	1.10	0.95	0.87	0.80	0.71	0.60
1812L110/16	1.58	1.43	1.27	1.10	0.95	0.85	0.77	0.71	0.58
1812L110/24	1.55	1.40	1.25	1.10	0.93	0.83	0.73	0.63	0.50
1812L110/33	1.55	1.40	1.25	1.10	0.93	0.83	0.73	0.63	0.50
1812L125/6	2.00	1.75	1.52	1.25	1.00	0.95	0.90	0.75	0.53
1812L125/16	2.00	1.75	1.52	1.25	1.00	0.95	0.90	0.75	0.53
1812L150	2.06	1.93	1.79	1.50	1.28	1.10	1.02	0.80	0.68
1812L150/12	2.04	1.88	1.68	1.50	1.25	1.10	1.00	0.80	0.60
1812L150/24	2.05	1.87	1.67	1.50	1.25	1.08	0.95	0.77	0.60
1812L160	2.20	2.06	1.91	1.60	1.36	1.17	1.09	0.85	0.72
1812L160/12	2.20	2.06	1.91	1.60	1.36	1.17	1.09	0.85	0.72
1812L200TH	2.60	2.44	2.22	2.00	1.78	1.67	1.50	1.45	1.29
1812L260TH	3.40	3.16	3.00	2.60	2.30	2.15	2.00	1.85	1.63
1812L260/12	3.40	3.16	3.00	2.60	2.30	2.15	2.00	1.85	1.63
1812L300	4.13	3.75	3.30	3.00	2.61	2.43	2.25	2.00	1.78

### Temperature Derating Curve

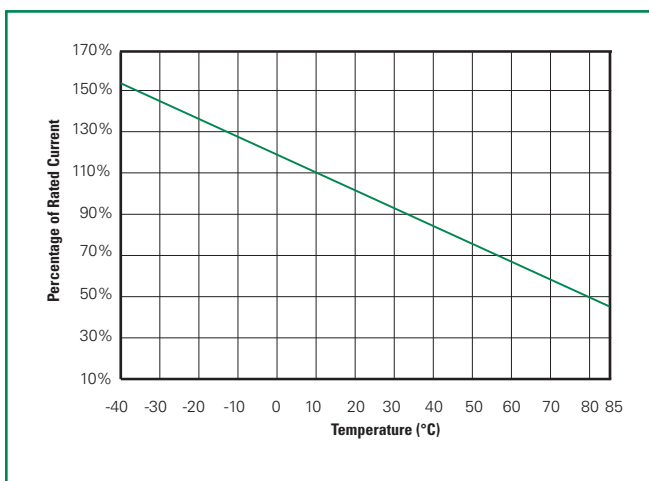

### Physical Specifications

<b>Terminal Material</b>	Solder-Plated Copper (Solder Material: Matte Tin (Sn))
<b>Lead Solderability</b>	Meets EIA Specification RS186-9E, ANSI/J-STD-002 Category 3.

### Environmental Specifications

<b>Operating/Storage Temperature</b>	-40°C to +85°C
<b>Max. Device Surface Temp. in Tripped State</b>	125°C
<b>Passive Aging</b>	+85°C, 1000 hours -/+5% typical resistance change
<b>Humidity Aging</b>	+85°C, 85% R.H., 1000 hours -/+5% typical resistance change
<b>Thermal Shock</b>	MIL-STD-202, Method 107G +85°C/-40°C 20 times -30% typical resistance change
<b>Solvent Resistance</b>	MIL-STD-202, Method 215, No change
<b>Vibration</b>	MIL-STD-883C, Method 2007.1, Condition A, No change
<b>Moisture Level Sensitivity</b>	Level 1, J-STD-020C

**Average Time Current Curves**

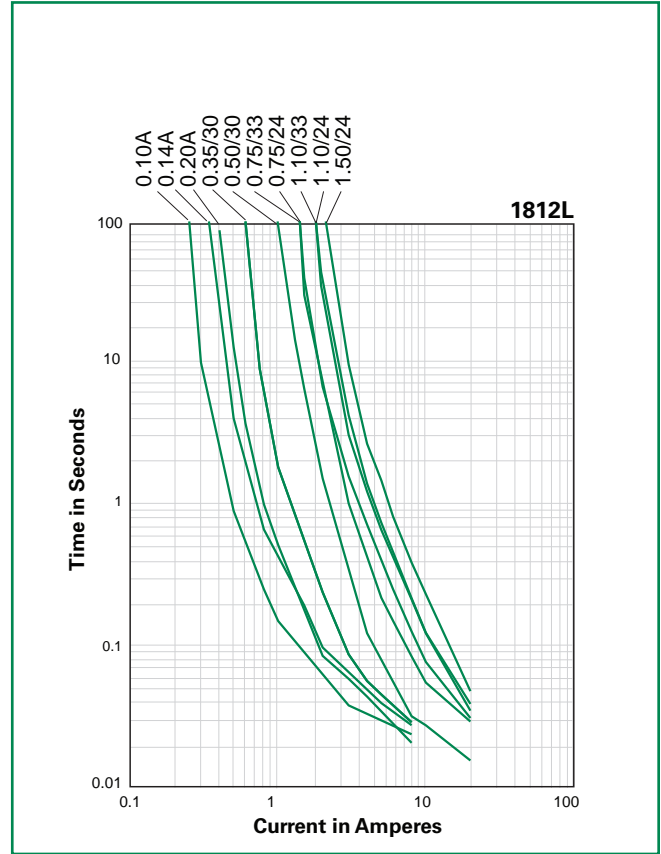
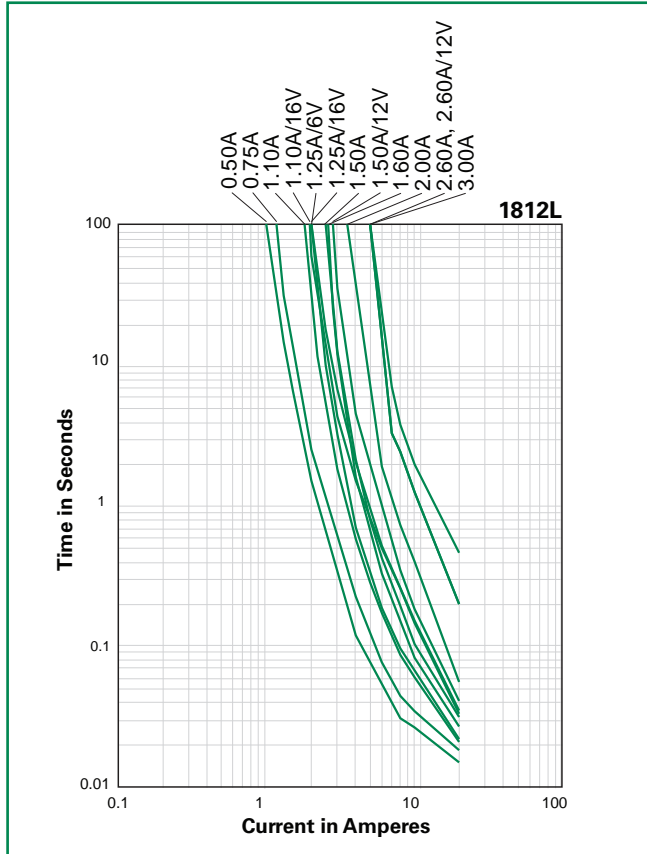

The average time current curves and Temperature Rerating curve performance is affected by a number of variables, and these curves provided as guidance only. Customer must verify the performance in their application.

1812L Series

**Soldering Parameters**

Condition	Reflow
Peak Temp/ Duration Time	260°C / 10 Sec
Time above liquids (TAL) 220°C	60 Sec ~ 100 Sec
Preheat 120°C~ 180°C	50 Sec ~ 150 Sec
Storage Condition	0°C~35°C, ≤70%RH

- Recommended reflow methods: IR, vapor phase oven, hot air oven, N<sub>2</sub> environment for lead-free
- Recommended maximum paste thickness is 0.25mm (0.010 inch)
- Devices can be cleaned using standard industry methods and solvents.

**Note:** If reflow temperatures exceed the recommended profile, devices may not meet the performance requirements.

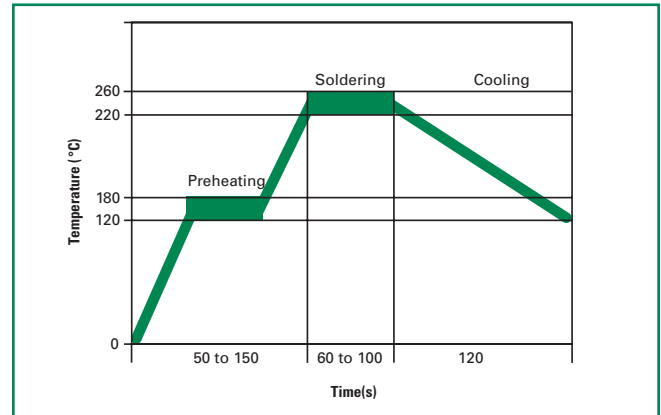

**Dimensions**

MARKING CODE VARIES  
WITH AMPERAGE AND VOLTAGE RATING  
(See Electrical Characteristics Table)  
SHOWN ARE:  
- 1.1A/6V RATING (LEFT)  
- 1.1A/33V RATING (RIGHT)

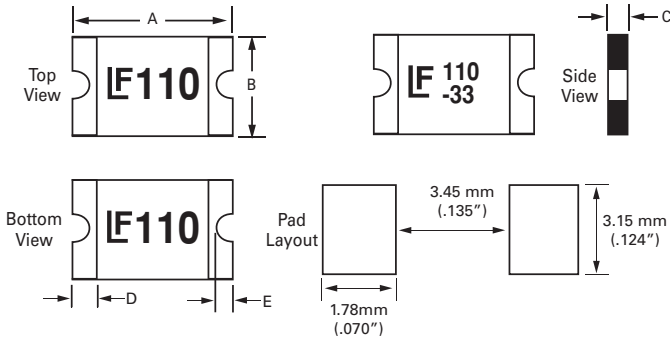

Part Number	A				B				C				D				E			
	Inches		mm		Inches		mm		Inches		mm		Inches		mm		Inches		mm	
	Min	Max	Min	Max	Min	Max	Min	Max	Min	Max	Min	Max	Min	Max	Min	Max	Min	Max	Min	Max
1812L010	0.17	0.19	4.37	4.73	0.12	0.13	3.07	3.41	0.03	0.05	0.75	1.25	0.01	0.05	0.3	1.2	0.01	0.03	0.25	0.65
1812L014	0.17	0.19	4.37	4.73	0.12	0.13	3.07	3.41	0.03	0.08	0.75	1.95	0.01	0.05	0.3	1.2	0.01	0.03	0.25	0.65
1812L020	0.17	0.19	4.37	4.73	0.12	0.13	3.07	3.41	0.02	0.04	0.55	1	0.01	0.05	0.3	1.2	0.01	0.03	0.25	0.65
1812L035/30	0.17	0.19	4.37	4.73	0.12	0.13	3.07	3.41	0.02	0.04	0.6	1.25	0.01	0.05	0.3	1.2	0.01	0.03	0.25	0.65
1812L050	0.17	0.19	4.37	4.73	0.12	0.13	3.07	3.41	0.02	0.03	0.5	0.75	0.01	0.05	0.3	1.2	0.01	0.02	0.25	0.5
1812L050/30	0.17	0.19	4.37	4.73	0.12	0.13	3.07	3.41	0.02	0.04	0.5	1	0.01	0.05	0.3	1.2	0.01	0.03	0.25	0.65
1812L075	0.17	0.19	4.37	4.73	0.12	0.13	3.07	3.41	0.02	0.03	0.5	0.75	0.01	0.05	0.3	1.2	0.01	0.02	0.25	0.5
1812L075/24	0.17	0.19	4.37	4.73	0.12	0.13	3.07	3.41	0.03	0.06	0.75	1.55	0.01	0.05	0.3	1.2	0.01	0.03	0.25	0.65
1812L075/33	0.17	0.19	4.37	4.73	0.12	0.13	3.07	3.41	0.03	0.06	0.75	1.55	0.01	0.05	0.3	1.2	0.01	0.03	0.25	0.65
1812L110	0.17	0.19	4.37	4.73	0.12	0.13	3.07	3.41	0.02	0.03	0.5	0.71	0.01	0.05	0.3	1.2	0.01	0.02	0.25	0.5
1812L110/24	0.17	0.19	4.37	4.73	0.12	0.13	3.07	3.41	0.02	0.04	0.5	1.07	0.01	0.05	0.3	1.2	0.01	0.03	0.25	0.65
1812L110/16	0.17	0.19	4.37	4.73	0.12	0.13	3.07	3.41	0.03	0.05	0.75	1.25	0.01	0.05	0.3	1.2	0.01	0.03	0.25	0.65
1812L110/33	0.17	0.19	4.37	4.73	0.12	0.13	3.07	3.41	0.05	0.08	1.2	2	0.01	0.05	0.3	1.2	0.01	0.03	0.25	0.65
1812L125/6	0.17	0.19	4.37	4.73	0.12	0.13	3.07	3.41	0.02	0.03	0.45	0.75	0.01	0.05	0.3	1.2	0.01	0.03	0.25	0.65
1812L125/16	0.17	0.19	4.37	4.73	0.12	0.13	3.07	3.41	0.03	0.05	0.75	1.25	0.01	0.05	0.3	1.2	0.01	0.02	0.25	0.5
1812L150	0.17	0.19	4.37	4.73	0.12	0.13	3.07	3.41	0.02	0.03	0.4	0.71	0.01	0.05	0.3	1.2	0.01	0.03	0.25	0.65
1812L150/12	0.17	0.19	4.37	4.73	0.12	0.13	3.07	3.41	0.03	0.05	0.75	1.25	0.01	0.05	0.3	1.2	0.01	0.03	0.25	0.65
1812L150/24	0.17	0.19	4.37	4.73	0.12	0.13	3.07	3.41	0.03	0.07	0.8	1.8	0.01	0.05	0.3	1.2	0.01	0.03	0.25	0.65
1812L160	0.17	0.19	4.37	4.73	0.12	0.13	3.07	3.41	0.02	0.03	0.4	0.75	0.01	0.05	0.3	1.2	0.01	0.03	0.25	0.65
1812L160/12	0.17	0.19	4.37	4.73	0.12	0.13	3.07	3.41	0.03	0.05	0.75	1.25	0.01	0.05	0.3	1.2	0.01	0.03	0.25	0.65
1812L200TH	0.17	0.19	4.37	4.73	0.12	0.13	3.07	3.41	0.008	0.024	0.2	0.6	0.01	0.05	0.3	1.2	0.01	0.02	0.25	0.5
1812L260TH	0.17	0.19	4.37	4.73	0.12	0.13	3.07	3.41	0.02	0.04	0.5	1.0	0.01	0.05	0.3	1.2	0.01	0.02	0.25	0.5
1812L260/12	0.17	0.19	4.37	4.73	0.12	0.13	3.07	3.41	0.03	0.05	0.8	1.34	0.01	0.05	0.3	1.2	0.01	0.03	0.25	0.65
1812L300	0.17	0.19	4.37	4.73	0.12	0.13	3.07	3.41	0.03	0.06	0.8	1.50	0.01	0.05	0.3	1.2	0.01	0.03	0.25	0.65

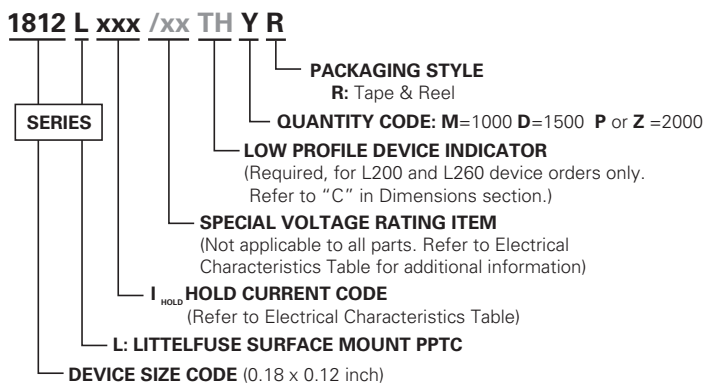
**Part Ordering Number System**

**Packaging**

Part Number	Ordering Number	Halogen Free	$I_{hold}$ (A)	$I_{hold}$ Code	Voltage Option	Packaging Option	Quantity	Quantity & Packaging Code
1812L010	1812L010DR	Yes	0.10	010		Tape and Reel	1500	DR
1812L014	1812L014DR	Yes	0.14	014			1500	DR
1812L020	1812L020PR	Yes	0.20	020			2000	PR
1812L035/30	1812L035/30DR	Yes	0.35	035	/30		1500	DR
1812L050	1812L050PR	Yes	0.50	050			2000	PR
1812L050/30	1812L050/30PR	Yes	0.50	050	/30		2000	PR
1812L075	1812L075PR	Yes	0.75	075			2000	PR
1812L75/24	1812L075/24DR	Yes	0.75	075	/24		1500	DR
1812L75/33	1812L075/33DR	Yes	0.75	075	/33		1500	DR
1812L110	1812L110PR	Yes	1.10	110			2000	PR
1812L110/16	1812L110/16DR	Yes	1.10	110	/16		1500	DR
1812L110/24	1812L110/24DR	Yes	1.10	1.10	/24		1500	DR
1812L110/33	1812L110/33MR	Yes	1.10	110	/33		1000	MR
1812L125/6	1812L125/6PR	Yes	1.25	125	/6		2000	PR
1812L125/16	1812L125/16DR	Yes	1.25	125	/16		1500	DR
1812L150	1812L150ZR	Yes	1.50	150			2000	ZR
1812L150/12	1812L150/12DR	Yes	1.50	150	/12		1500	DR
1812L150/24	1812L150/24MR	Yes	1.50	150	/24		1000	MR
1812L160	1812L160PR	Yes	1.60	160			2000	PR
1812L160/12	1812L160/12DR	Yes	1.60	160	/12		1500	DR
1812L200TH	1812L200THPR	Yes	2.00	200		2000	PR	
1812L260TH	1812L260THDR	Yes	2.60	260		1500	DR	
1812L260/12	1812L260/12MR	Yes	2.60	260	/12	1000	MR	
1812L300	1812L300MR	Yes	3.00	300		1000	MR	

**Tape and Reel Specifications**

TAPE SPECIFICATIONS: EIA-481-1 (mm)			
	1812L020 1812L035/30 1812L050 1812L075 1812L110 1812L125/6 1812L150 1812L160 1812L200TH	1812L010 1812L014 1812L050/30 1812L075/24 1812L075/33 1812L110/16 1812L110/24 1812L125/16 1812L150/12 1812L160/12 1812L260TH	1812L110/33 1812L150/24 1812L260/12 1812L300
<b>W</b>	12.00+0.30-0.10	12.00+/-0.30	12.00+/-0.30
<b>F</b>	5.50+/-0.05	5.50+/-0.05	5.50+/-0.05
<b>E<sub>1</sub></b>	1.75+/-0.10	1.75+/-0.10	1.75+/-0.10
<b>D<sub>0</sub></b>	1.50+0.10	1.55+/-0.05	1.55+/-0.05
<b>D<sub>1</sub></b>	1.50+0.25	1.50 (MIN)	1.50 (MIN)
<b>P<sub>0</sub></b>	4.00+/-0.10	4.00+/-0.10	4.00+/-0.10
<b>P<sub>1</sub></b>	8.00+/-0.10	8.00+/-0.10	8.00+/-0.10
<b>P<sub>2</sub></b>	2.00+/-0.05	2.00+/-0.05	2.00+/-0.05
<b>A<sub>0</sub></b>	3.58+/-0.10	3.58+/-0.10	3.58+/-0.10
<b>B<sub>0</sub></b>	4.93+/-0.10	4.93+/-0.10	4.93+/-0.10
<b>T</b>	0.25+/-0.10	0.25+/-0.10	0.25+/-0.10
<b>K<sub>0</sub></b>	0.87+/-0.06	1.25+/-0.10	2.10+/-0.10
Leader min.	390	390	390
Trailer min.	160	160	160

**REEL DIMENSIONS:  
EIA-481-1 (mm)**

<b>H</b>	16.0+/-0.2
<b>W</b>	13.2+/-1.5
<b>D</b>	Ø60.2+/-0.5
<b>F</b>	Ø13.0+/-0.5
<b>C</b>	Ø178+/-1.0
<b>H<sub>1</sub></b>	11+/-0.5
<b>W<sub>1</sub></b>	2.5+0.5
<b>W<sub>2</sub></b>	3.0+0.5
<b>W<sub>3</sub></b>	4.0+0.5
<b>W<sub>4</sub></b>	5.0+0.5

