

Soft Recovery Diode

Types M0437WC080 to M0437WC140

The data sheet on the subsequent pages of this document is a scanned copy of existing data for this product.
(Rating Report 80NR1 Issue 3)

This data reflects the old part number for this product which is: SM02-14CXC170.
This part number must **NOT** be used for ordering purposes – please use the ordering particulars detailed below.

Limitations of this data are as follows:
This device is only available for grades 08 to 14 (800V to 1400V V_{RRM})

The following link will direct you to the appropriate outline drawing
[Outline W1](#)



Where any information on the product matrix page differs from that in the following data, the product matrix must be considered correct

An electronic data sheet for this product is presently in preparation.

For further information on this product, please contact your local ASM or distributor.

Alternatively, please contact Westcode as detailed below.

Ordering Particulars			
M0437	WC	◆◆	0
Fixed Type Code	Fixed Outline Code	Voltage code $V_{RRM}/100$ 08-14	Fixed Code
Typical Order Code: M0437WC140, 14mm clamp height, 1400V V_{RRM}			

<p>IXYS Semiconductor GmbH Edisonstraße 15 D-68623 Lampertheim Tel: +49 6206 503-0 Fax: +49 6206 503-627 E-mail: marcom@ixys.de</p>	 An  IXYS Company	<p>Westcode Semiconductors Ltd Langley Park Way, Langley Park, Chippenham, Wiltshire, SN15 1GE. Tel: +44 (0)1249 444524 Fax: +44 (0)1249 659448 E-mail: WSL.sales@westcode.com</p>	
<p>IXYS Corporation 3540 Bassett Street Santa Clara CA 95054 USA Tel: +1 (408) 982 0700 Fax: +1 (408) 496 0670 E-mail: sales@ixys.net</p>	<p>www.westcode.com</p> <p>www.ixys.com</p>	<p>Westcode Semiconductors Inc 3270 Cherry Avenue Long Beach CA 90807 USA Tel: +1 (562) 595 6971 Fax: +1 (562) 595 8182 E-mail: WSI.sales@westcode.com</p>	
<p>The information contained herein is confidential and is protected by Copyright. The information may not be used or disclosed except with the written permission of and in the manner permitted by the proprietors Westcode Semiconductors Ltd.</p>			<p>© Westcode Semiconductors Ltd.</p>
<p>In the interest of product improvement, Westcode reserves the right to change specifications at any time without prior notice.</p>			
<p>Devices with a suffix code (2-letter, 3-letter or letter/digit/letter combination) added to their generic code are not necessarily subject to the conditions and limits contained in this report.</p>			

QUALITY EVALUATION LABORATORY

Rating Report: 8ONR1 (Issue 3)

Date: 18th November, 1991

Origin:

Pages: 22

Diode Type SM02-14CXC170

Written by: *M.W. Dunlop*

Checked: *M.W.*

Approved: *[Signature]*

This diode consists of a diffused, fast recovery 24 mm diameter silicon slice mounted in a cold weld capsule housing. This Report supersedes Rating report 8ONR1: (Issue 2).

Ratings

Voltage Grades	:	02-14
V_{RSM}	:	300-1500V
V_{RRM}	:	200-1400V
$I_F(AV)$: Single phase; 50 Hz, 180° half sinewave; (Converter Ratings) :		
Double Side Cooled $T_{HSE} = 55^{\circ}C, 100^{\circ}C$:	438A, 202A
Single Side Cooled $T_{HS} = 100^{\circ}C$:	114A
$I_F(rms)$ $T_{HS} = 25^{\circ}C$)	:	880A
I_F $T_{HS} = 25^{\circ}C$) Double side cooled	:	727A
I_{FSM} : t = 10ms half sinewave; T_J (initial) = 125°C ; $V_{RM} = 0.6V_{RRM(MAX)}$:	4500A
I_{FSM} : t = 10ms half sinewave; T_J (initial) = 125°C ; $V_{RM} = 10V$:	4950A
I^2t : t = 10ms; T_J (initial) = 125°C ; $V_{RM} = 0.6V_{RRM(MAX)}$:	$1.01 \times 10^5 A^2s$
I^2t : t = 10ms; T_J (initial) = 125°C ; $V_{RM} \leq 10V$:	$1.22 \times 10^5 A^2s$
I^2t : t = 3ms; T_J (initial) = 125°C ; $V_{RM} \leq 10V$:	$0.91 \times 10^5 A^2s$
T_{HS} Operating Range	:	-40 to +125
T_{stg} ; Non-operating	:	-40 to +150

Characteristics

(Maximum values unless stated otherwise)

V_D : $T_J = 125^\circ\text{C}$: 1.02V
r_s : $T_J = 125^\circ\text{C}$: 0.7mohms
V_{FM} : $I_{FM} = 635\text{A}$ $T_{VJ} = 125^\circ\text{C}$: 1.46V
R_{th} (J-HS) Double side cooled	: 0.09°C/W
Single side cooled	: 0.18°C/W
I_{RRM} : $T_J = 125^\circ\text{C}$ $V_{RM} = V_{RRM}(\text{MAX})$: 20mA
Q_{rr} : $I_{FM} = 550\text{A}$; $dI/dt = 40\text{A}/\mu\text{S}$ (50% chord value)	:
$V_{RM} = 50\text{V}$ $T_{VJ} = 125^\circ\text{C}$: 75 μC
t_{rr} (conditions as above)	: 3 μS
Mounting Force	: 330-550kg.f
Outline Drawing	: 10A241
JEDEC No.	: D0200AA

CONTENTS

	<u>Page</u>
Ratings and Characteristics	1, 2
Voltage Grade Table	4
(2) <u>Introduction</u>	5
(3) <u>Notes on the Ratings</u>	
(a) Square-wave ratings	5
(b) Energy per pulse characteristics	5
(4) <u>Reverse Recovery Loss</u>	
(a) Determination by Measurement	5
(b) Design Method	6
Limit Forward Characteristic	7
Transient Thermal Impedance	8
Surge Rating	9
Recovered Charge	10
S. Factor	11
Reverse recovery energy per pulse	12
Square wave frequency rating 85°C Sink 200A/uS	13
Square wave frequency rating 55°C Sink 200A/uS	14
Square wave frequency rating 85°C Sink 100A/uS	15
Square wave frequency rating 55°C Sink 100A/uS	16
Energy per pulse 200A/uS	17
Energy per pulse 100A/uS	18
Sine wave frequency rating 85°C Sink	19
Sine wave frequency rating 55°C Sink	20
Sine wave energy per pulse	21
Outline drawing	22

CHANGES TO 80NR1 (Issue 2)

Voltage Grade increased from 12 to 14.

Voltage Ratings

Voltage Class	V_{RRM} V	V_{RSM} V
02	200	300
04	400	500
06	600	700
08	800	900
10	1000	1100
12	1200	1300
14	1400	1500

This Report is applicable to higher or lower voltage grades when supply has been agreed by Sales/Production.

2.0 INTRODUCTION

The diode series comprises fast recovery cold-weld capsules with all diffused silicon slices. All these diodes have controlled reverse recovery characteristics with good "S" factors.

3.0 NOTES ON THE RATINGS

(a) Square wave ratings

These ratings are given for leading edge linear rates of rise of forward current of 200 and 100A/uS

(b) Energy per pulse characteristics

These curves enable rapid estimation of device dissipation to be obtained for conditions not covered by the frequency ratings.

Let: E_p be the Energy per pulse for a given current and pulse width, in joules.

Then $W_{AV} = E_p \times f$.

and $T_{SINK} = T_{J(MAX)} - W_{AV} R_{th}$

4.0 REVERSE RECOVERY LOSS

On account of the number of circuit variables affecting reverse recovery voltage, no allowance for reverse recovery loss has been made in these ratings. The following procedure is recommended for use where it is necessary to include reverse recovery loss.

(a) Determination by Measurement

From waveforms of recovery current obtained from a high frequency shunt (see Note 1) and reverse voltage present during recovery, an instantaneous reverse recovery loss waveform must be constructed. Let the area under this waveform be A joules per pulse. A new heat sink temperature can then be evaluated from:

$$T_{SINK} \text{ (new)} = T_{SINK} \text{ (original)} - A \left(\frac{r_t \cdot 10^6}{t} + R_{th} \times f \right)$$

$$\text{where } r_t = 1.64 \times 10^{-4} \sqrt{t}$$

t = duration of reverse recovery loss per pulse in microseconds

A = Area under reverse loss waveform per pulse in joules (W.S.)

f = rated frequency at the original heat sink temperature

The total dissipation is now given by

$$W_{(TOT)} = W_{(original)} + A \times f$$

NOTE 1

REVERSE RECOVERY LOSS BY MEASUREMENT

This device has a low reverse recovered charge and peak reverse recovery current. When measuring the charge care must be taken to ensure that:

- (a) a.c. coupled devices such as current transformers are not affected by prior passage of high amplitude forward current.
- (b) The measuring oscilloscope has adequate dynamic range - typically 100 screen heights - to cope with the initial forward current without overload.
- (c) Measurement of reverse recovery voltage waveform should be carried out with an appropriate snubber of 0.1uF and 10 ohms in series connected across diode anode to cathode.

(b) Design Method

In circumstances where it is not possible to measure voltage and current conditions, or for design purposes, the additional losses may be estimated from curves on page 12.

Let E be the value of energy per reverse cycle in joules (curves on page 12)

Let f be the operating frequency in Hz

$$\text{Then } T_{\text{SINK}}^{(\text{new})} = T_{\text{SINK}}^{(\text{original})} - E \times R_{\text{th}} \times f$$

Where $T_{\text{SINK}}^{\text{new}}$ is the required maximum heat sink temperature and $T_{\text{SINK}}^{\text{original}}$ is the heat sink temperature given with the frequency ratings.

FORWARD CHARACTERISTIC OF LIMIT DEVICE

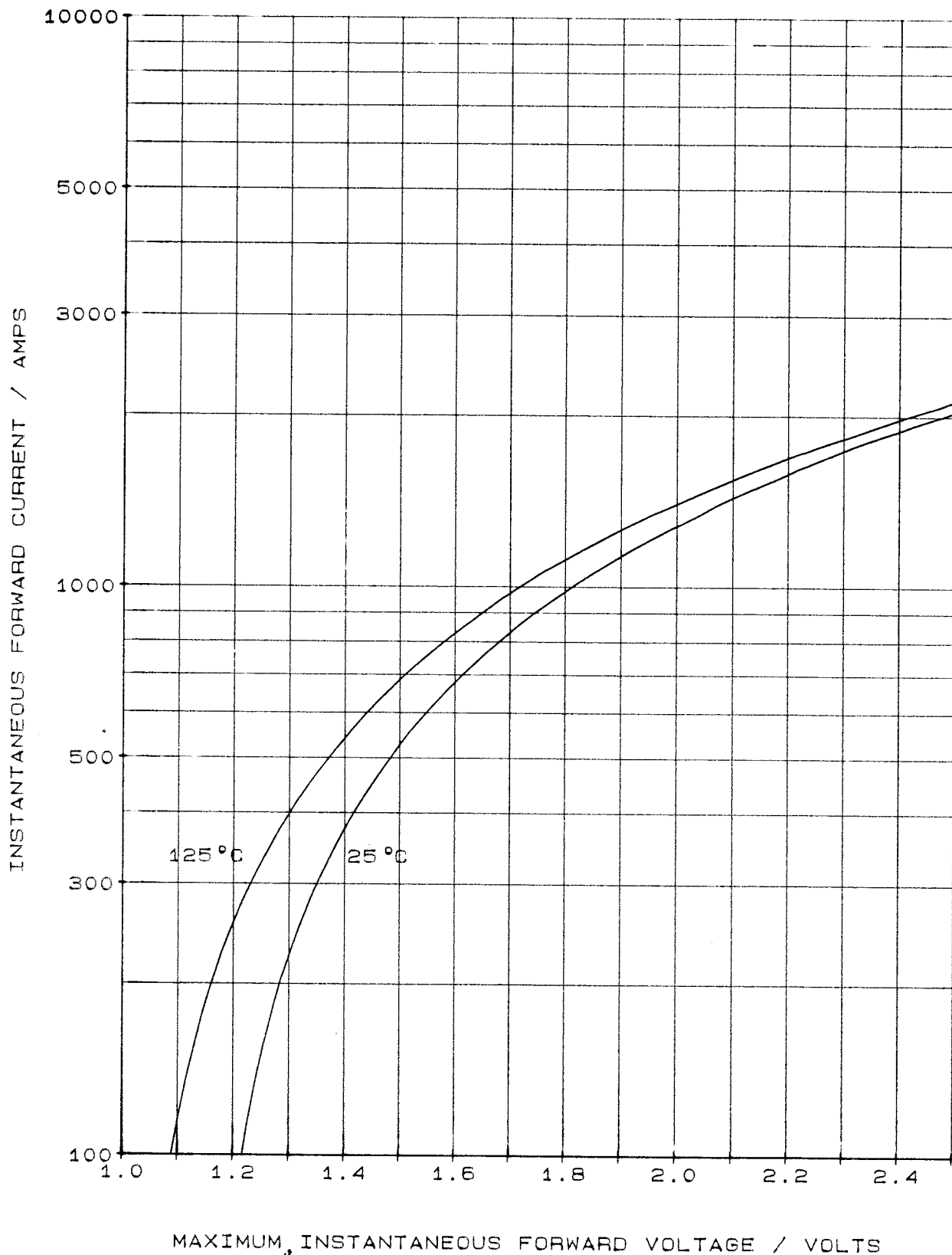

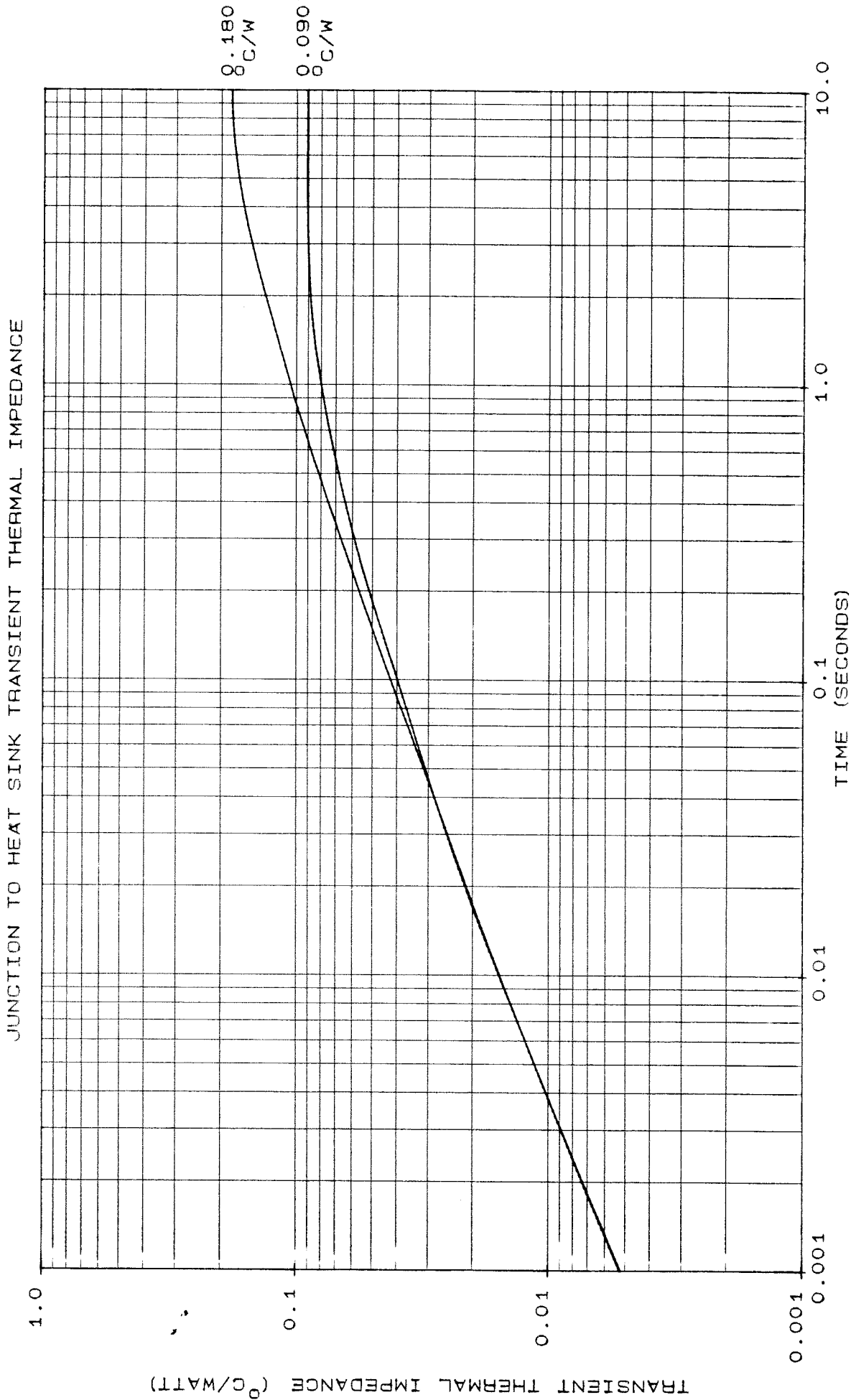

MAXIMUM NON REPETITIVE SURGE CURRENT AT INITIAL JUNCTION TEMPERATURE 125°C

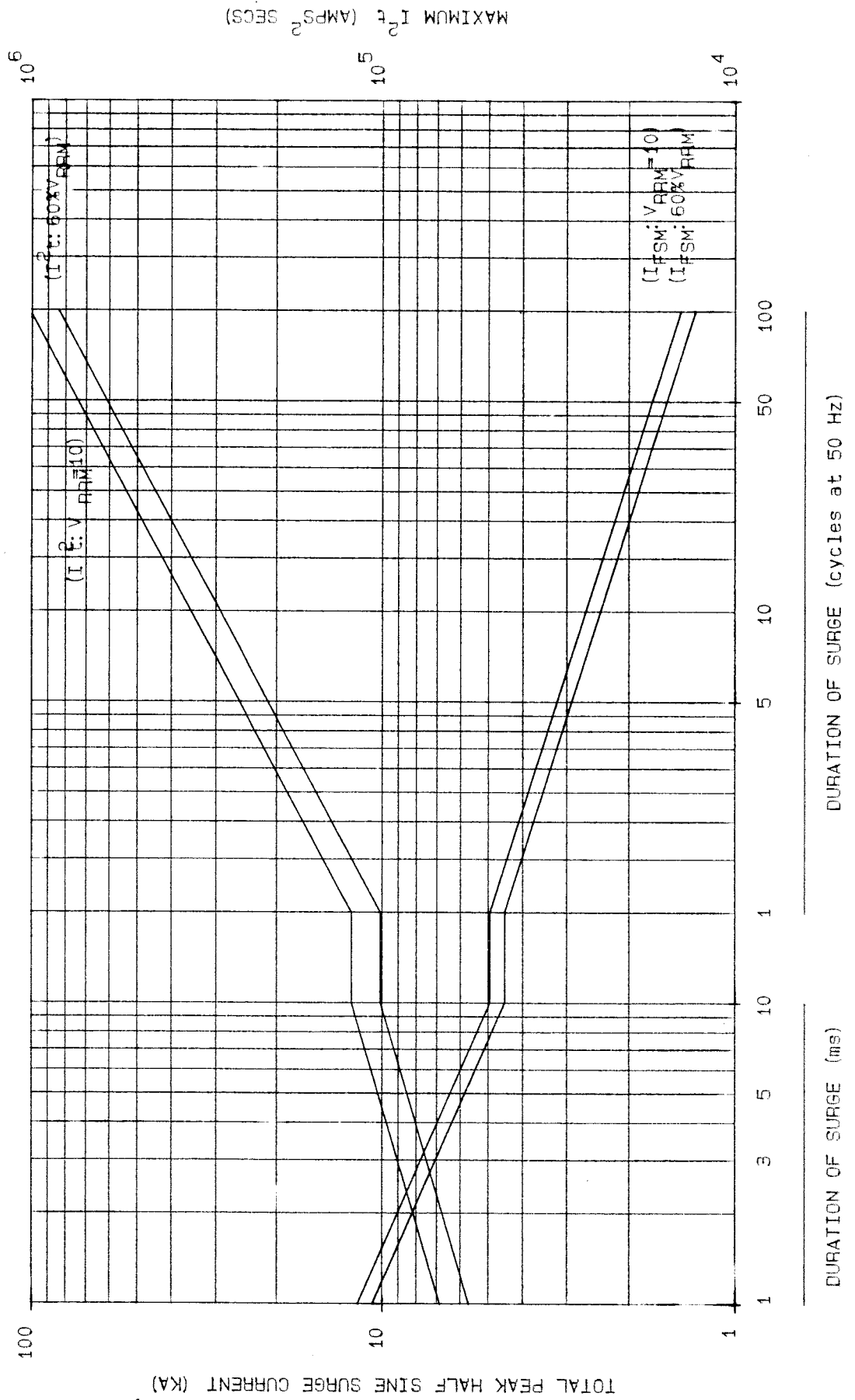

TOTAL PEAK HALF SINE SURGE CURRENT (KA)

MAXIMUM I^2t (AMPS² SECS)

10^6

10^5

10^4

100

10

1

(I²t: 600V RRM)

(I²t: V RRM=10)

(I²t: 600V RRM)

(I²t: V RRM=10)

DURATION OF SURGE (cycles at 50 Hz)

DURATION OF SURGE (ms)

MAXIMUM RECOVERED CHARGE AT 125°C JUNCTION TEMPERATURE

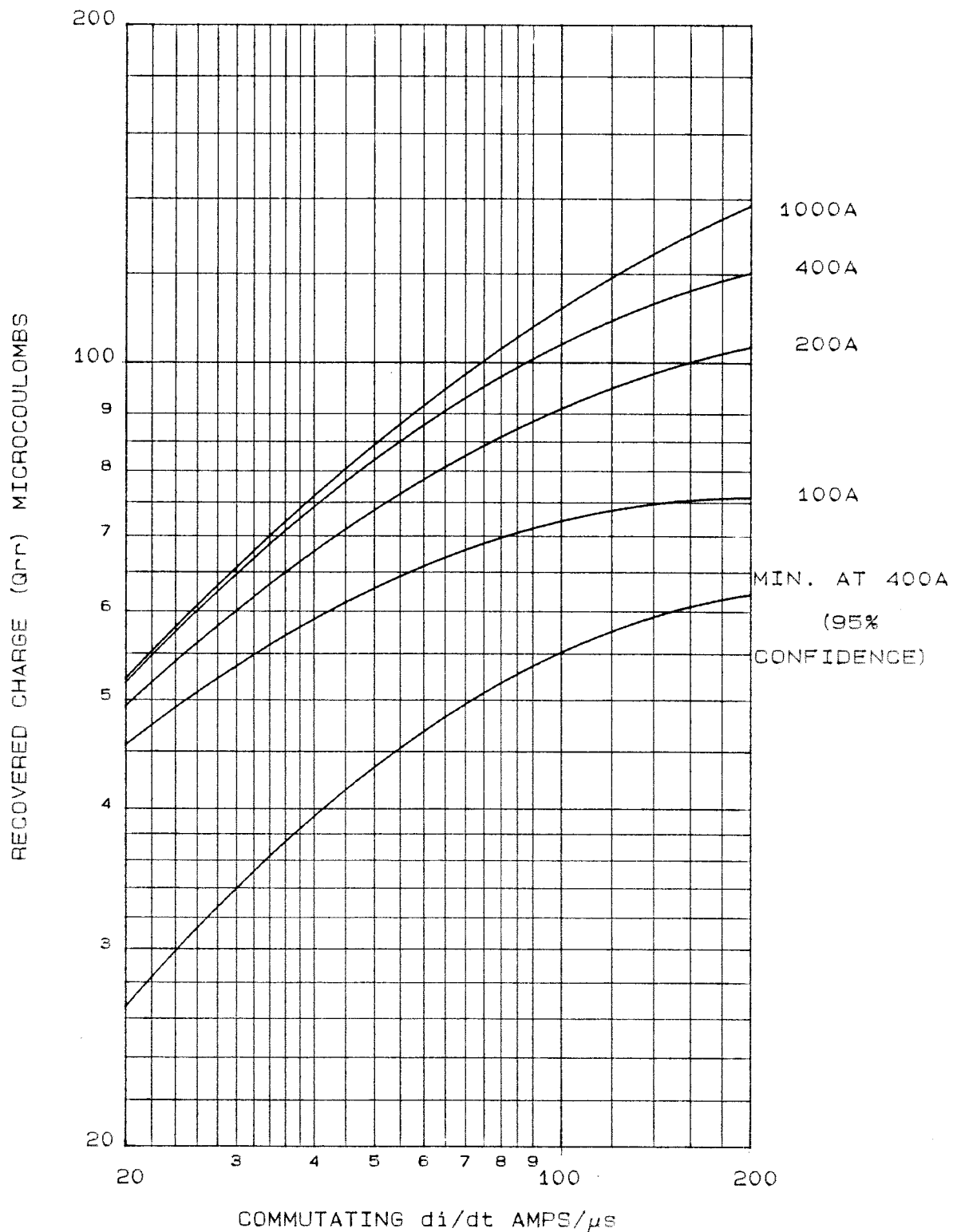

MINIMUM S FACTOR AT 125°C JUNCTION TEMPERATURE

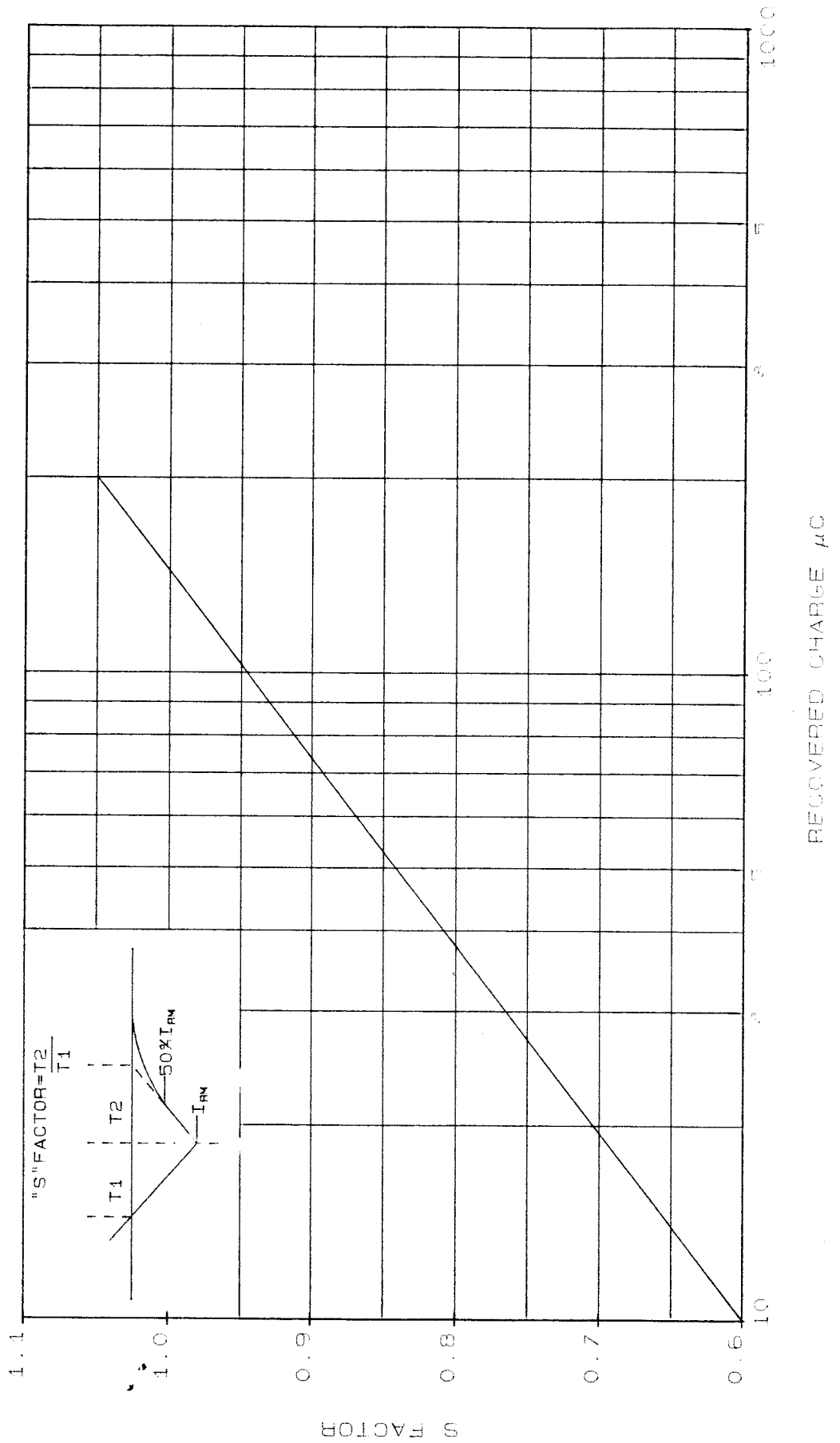

MAXIMUM REVERSE RECOVERY ENERGY LOSS PER PULSE, 125°C JUNCTION TEMPERATURE

SNUBBER CONNECTED 0.10μF, 10 OHMS
PEAK REVERSE VOLTAGE VRM = 0.67 OF HIGHEST GRADE VOLTAGE *

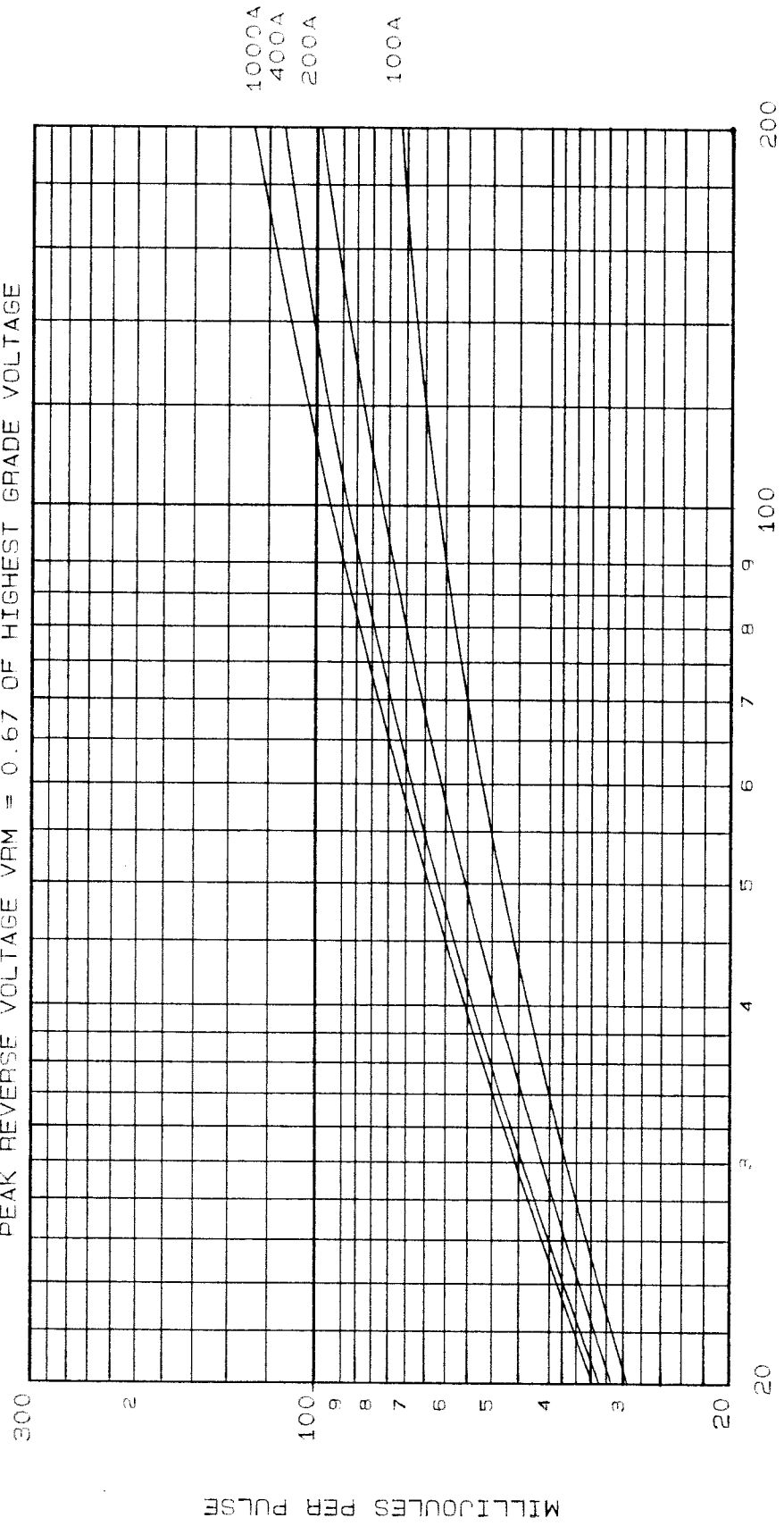

* NOTE: ENERGY PER PULSE SHOULD BE ADJUSTED PRO RATA WITH APPLIED PEAK RECOVERY VOLTAGE

T SINK 85°C. 200A/μs

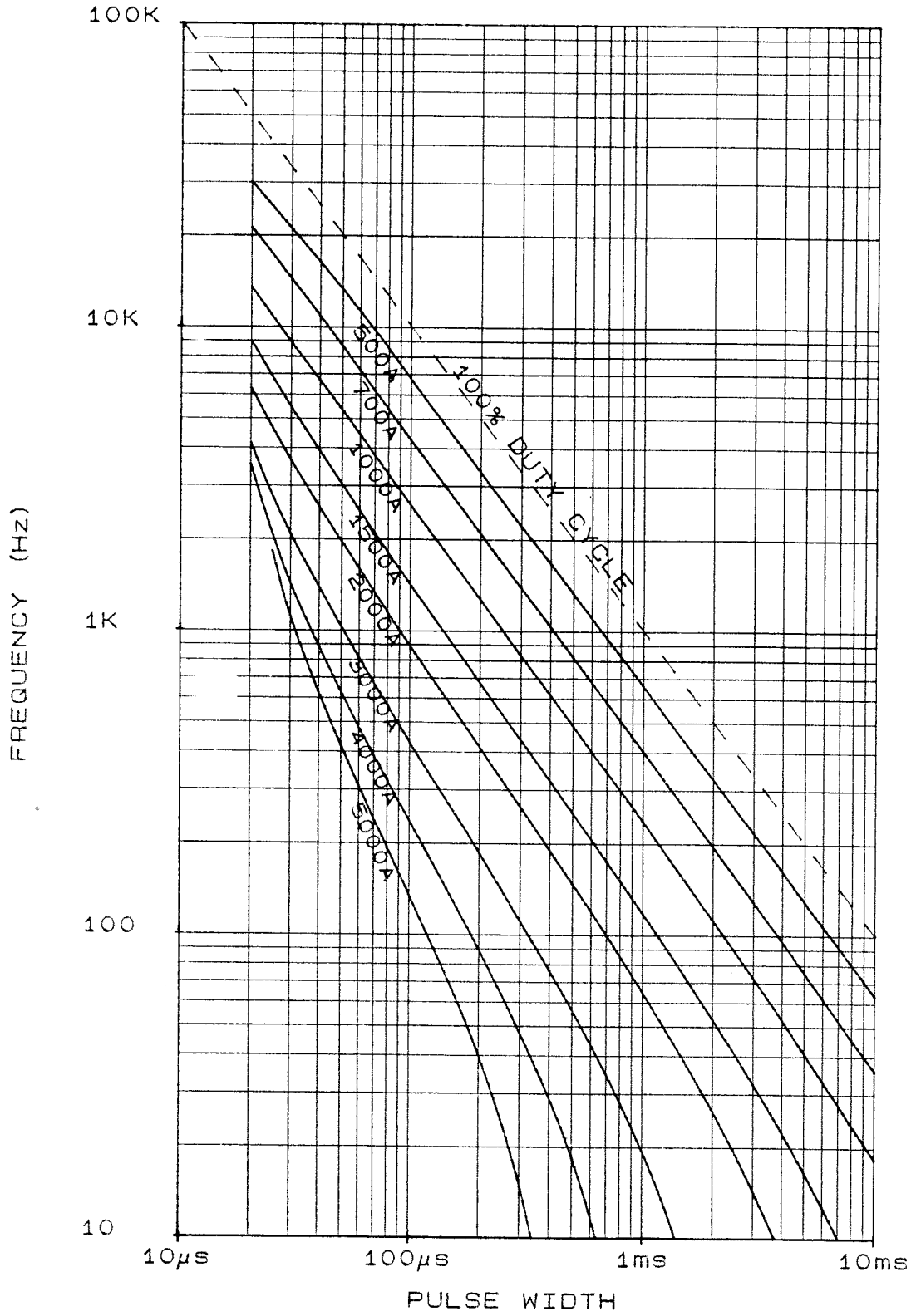

T SINK 55°C. 200A/μs

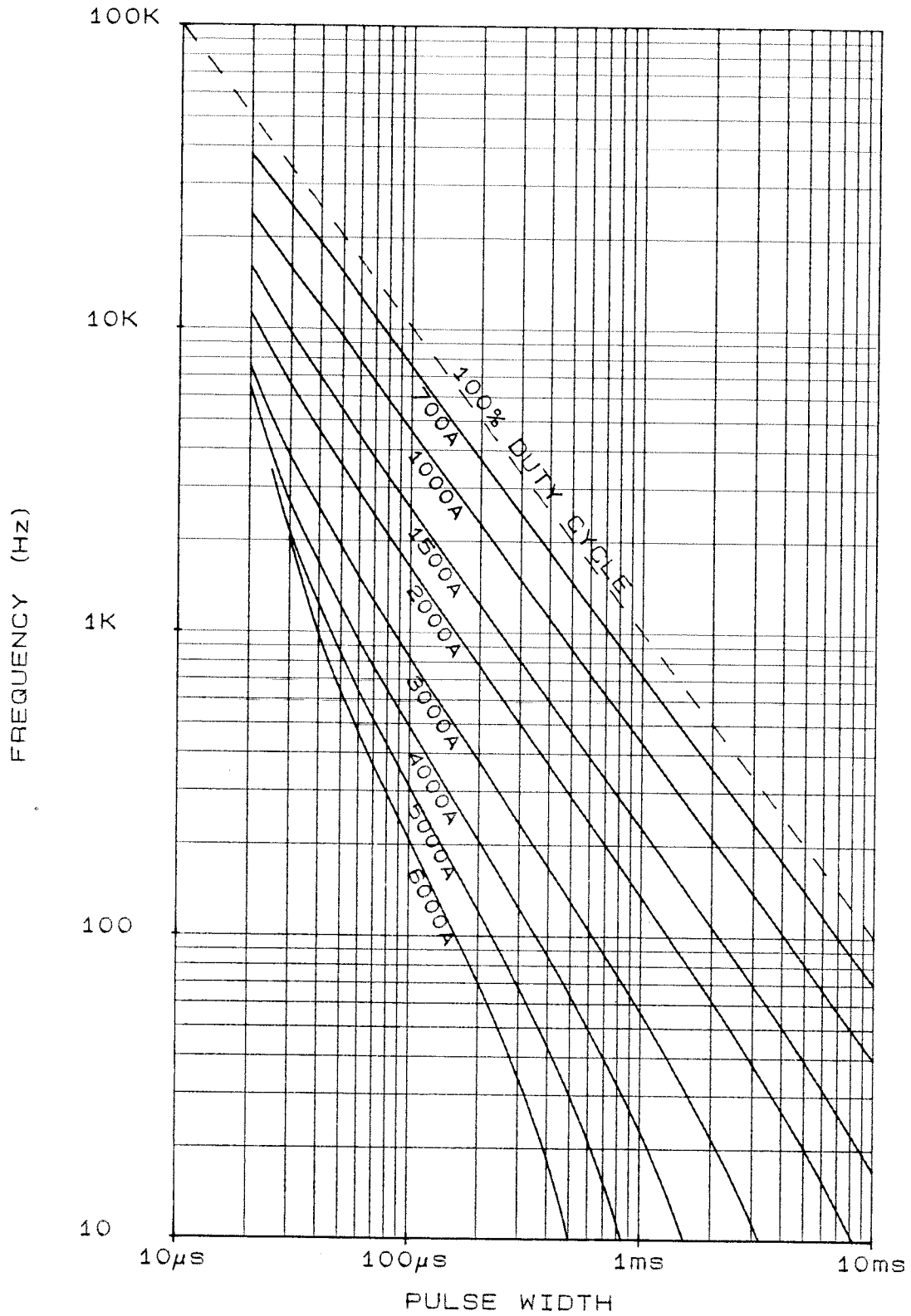

T SINK 55°C. 100A/μs

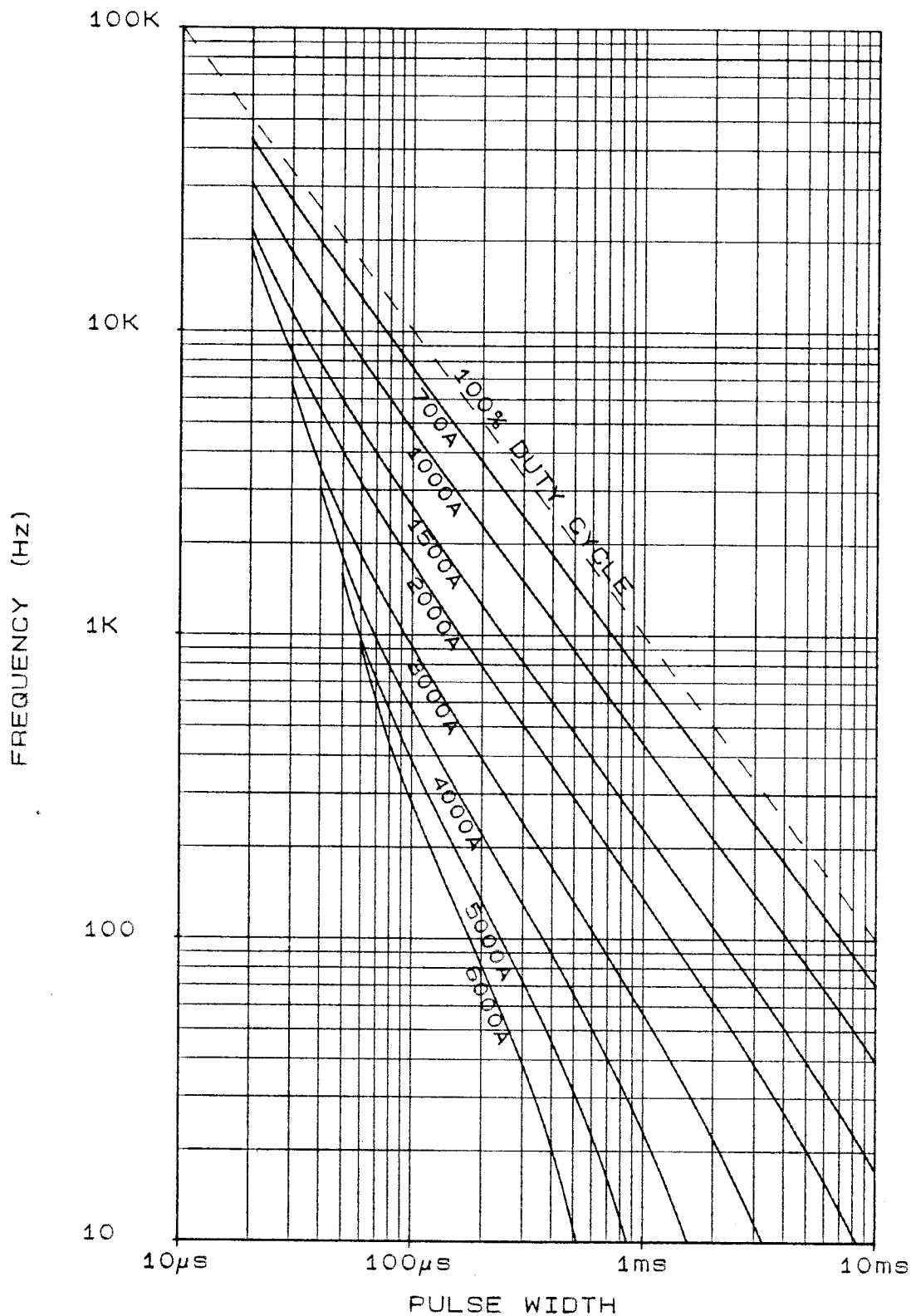

Tj 125°C. 200A/μs

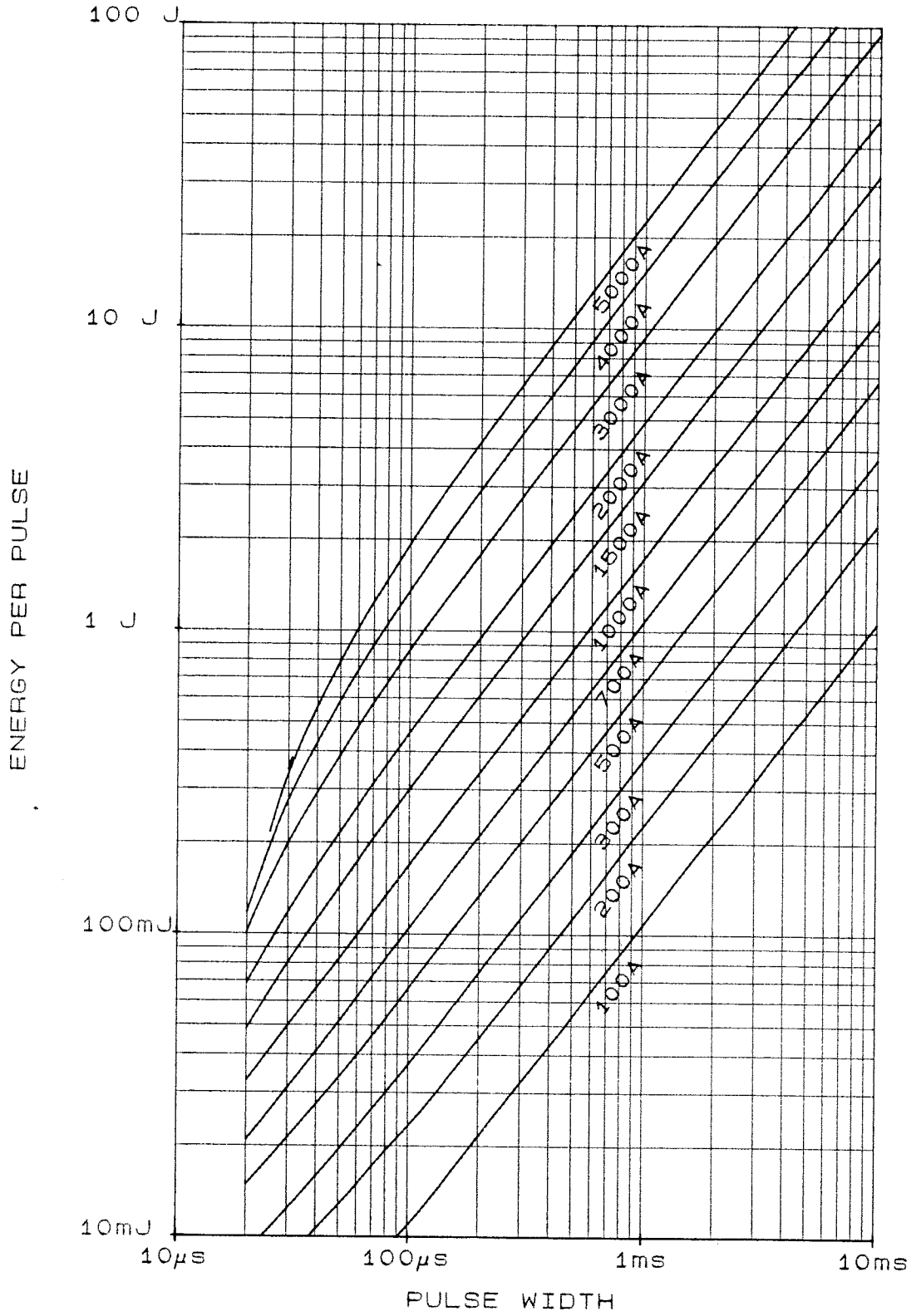

Tj 125°C. 100A/μs

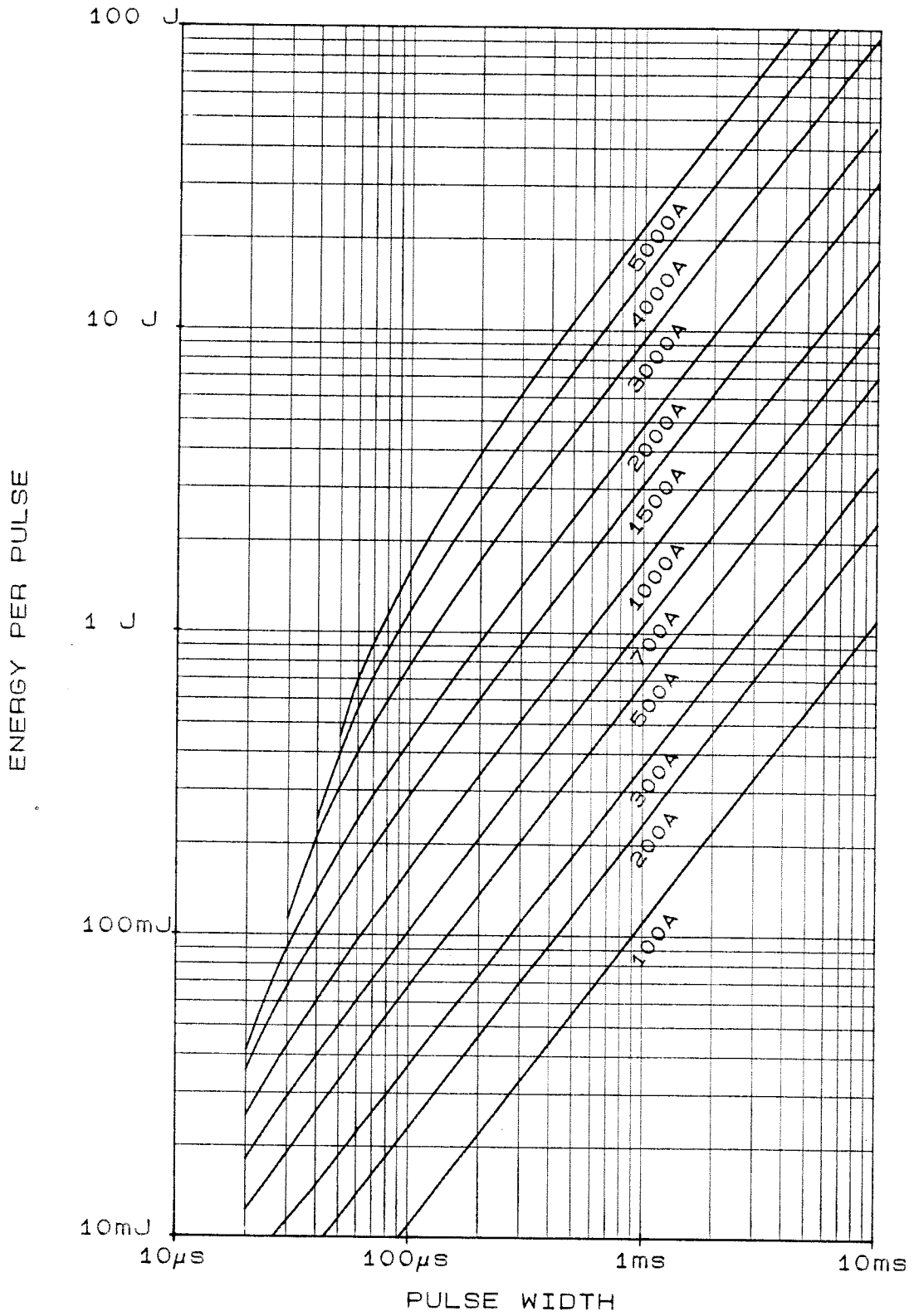

T SINK 85°C. SINE WAVE

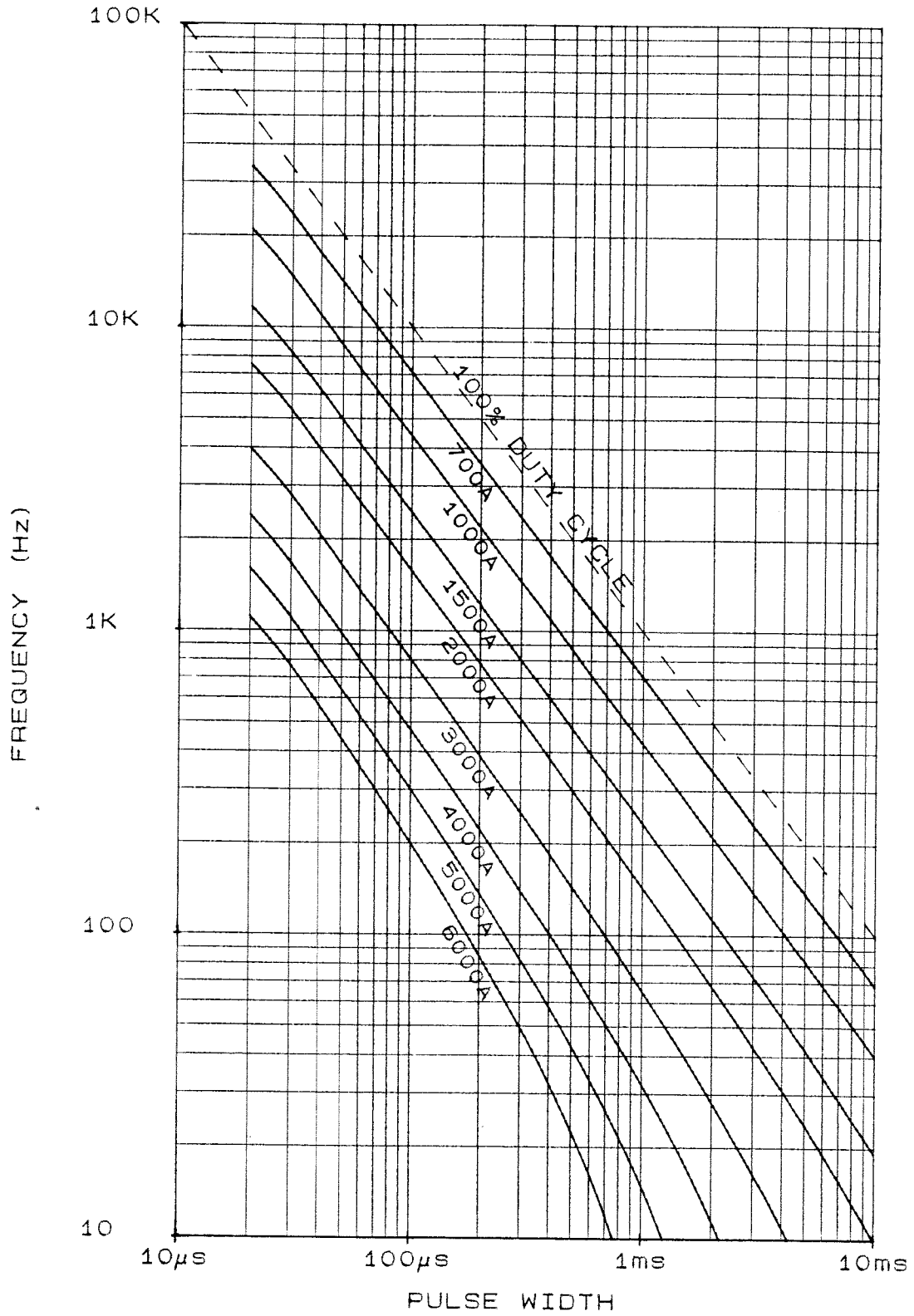

T SINK 55°C.
SINE WAVE

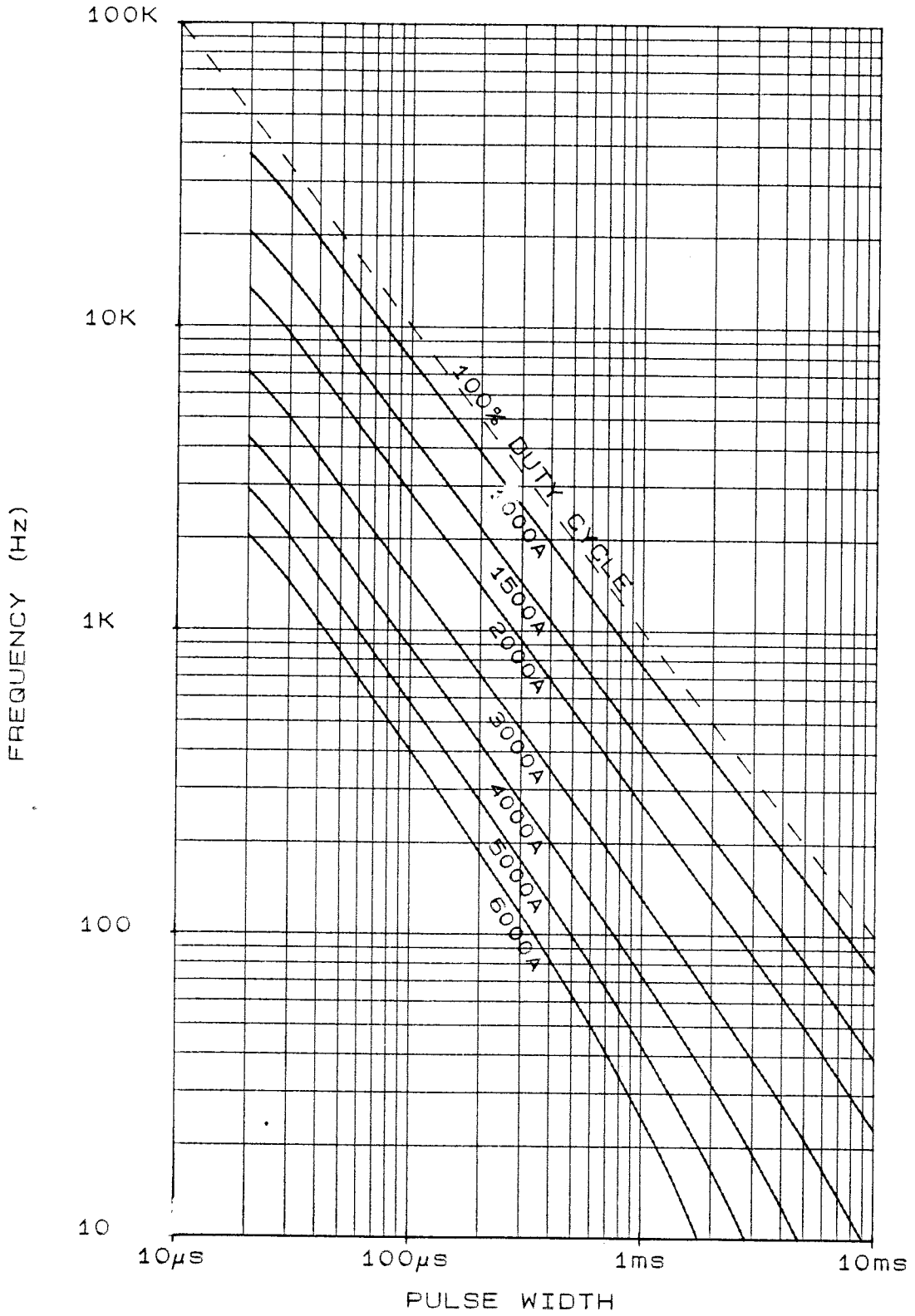

Tj 125°C. SINE WAVE

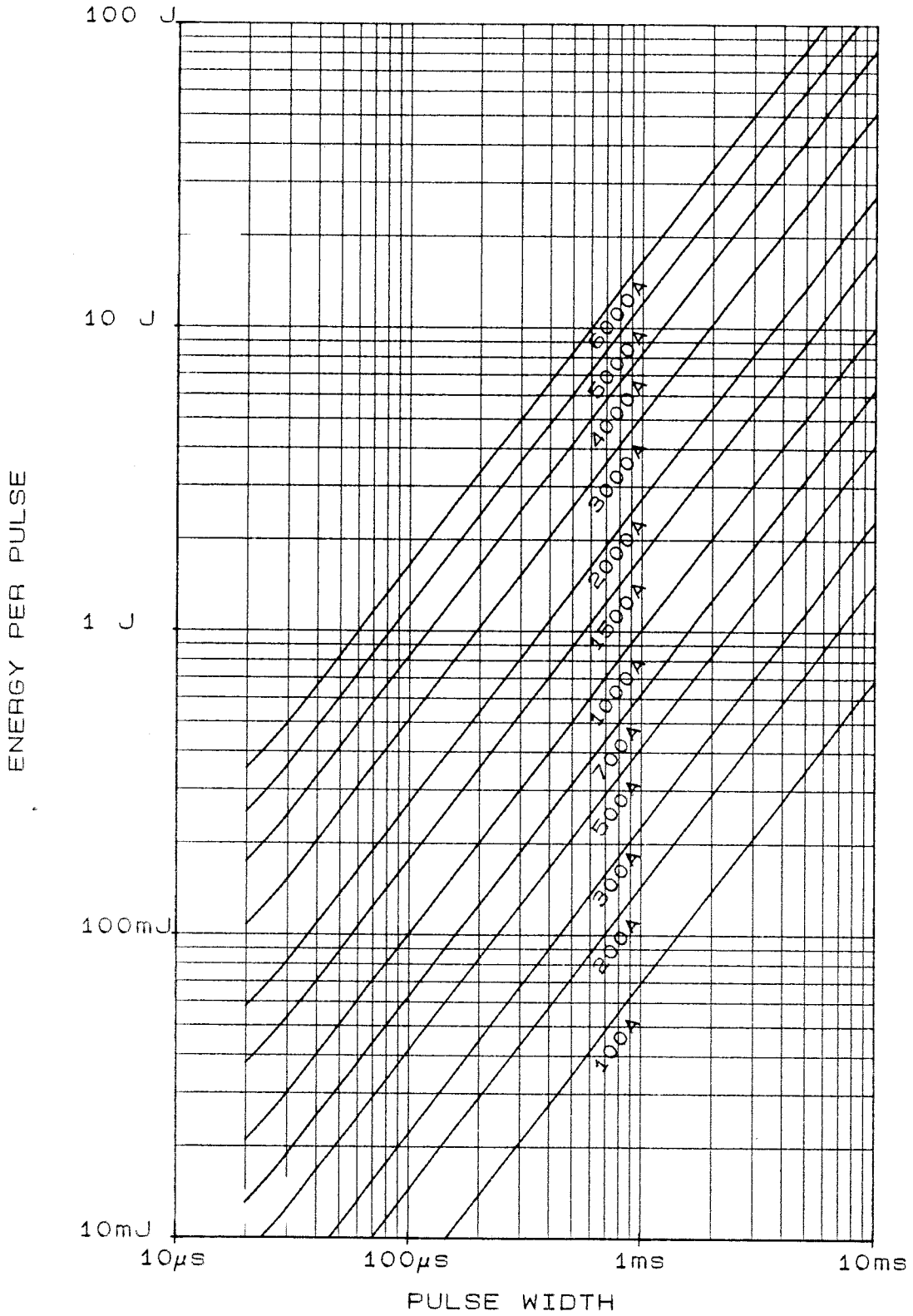

INTERNATIONAL OUTLINE No. DO-200AA - 22 -
 G.A. DWG No. 159B100H100-H110.
 WEIGHT. 70 GRAMS
 FINISH. NICKEL PLATE
 DEVICE MOUNTING: CLAMPING FORCE TO BE APPLIED ON
 CENTRE LINE OF LOCATION HOLES AND BE EVENLY
 DISTRIBUTED OVER AREA OF CONTACT. FLAT TOL. ON
 SURFACES TO WHICH DEVICE IS CLAMPED TO BE 0.04 WIDE.
 CLAMPING FORCE = 330-550kgf.

TYPE NUMBER	
CXC300	CXC134
CXC320	CXC144
CXC380	CXC170
CXC400	CXC174
CXC470	

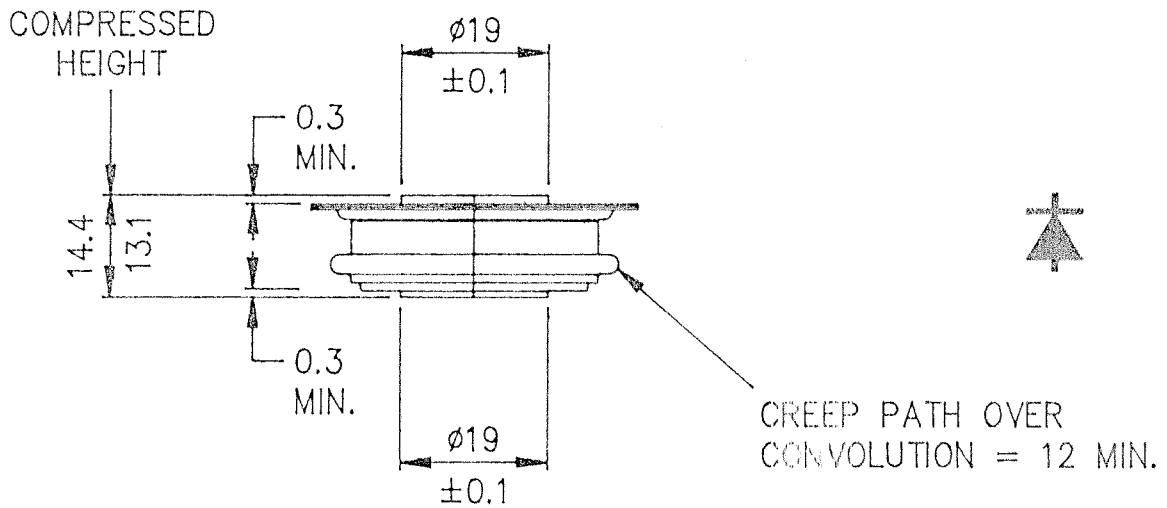
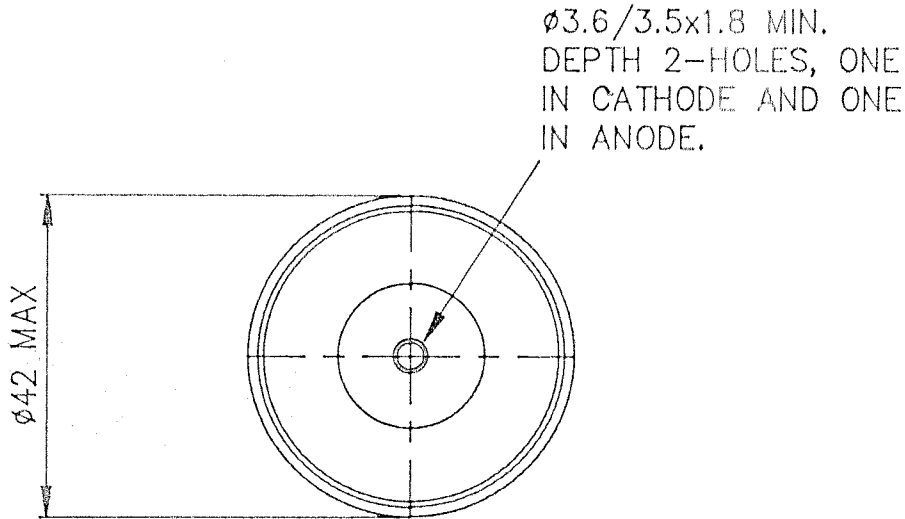

THE INFORMATION CONTAINED IN THIS DWG IS PROTECTED BY COPYRIGHT. THE INFORMATION MAY NOT BE DISCLOSED EXCEPT WITH THE WRITTEN PERMISSION OF WESTCODE SEMICONDUCTORS LIMITED.

SCALE 1/1	ISS	REVISIONS
DRAWN HDN/10		10-09-90
		REDRAWN ON CAD HDN

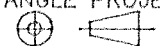
THIRD ANGLE PROJECTION.

 DWG. COMPLIES WITH BS 308.
 DIMNS. IN MILLIMETRES.
 DWG No. 100A241

WESTCODE SEMICONDUCTORS LTD.,
 P.O. BOX 57, CHIPPENHAM, WILTSHIRE, SN15 1JL, ENGLAND.
 TEL 0249 654141. TELEX 44751 WESCDE G. TELEFAX 0249 639448.