

Three phase full Bridge

with Trench MOSFETs
in DCB isolated high current package

$V_{DSS} = 75 \text{ V}$
 $I_{D25} = 125 \text{ A}$
 $R_{DSon \text{ typ.}} = 3.7 \text{ m}\Omega$

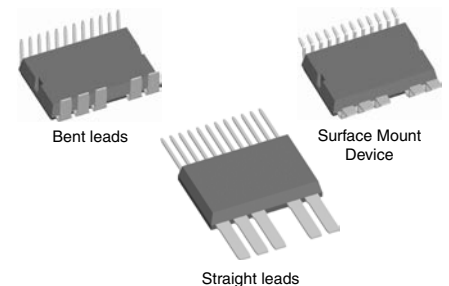
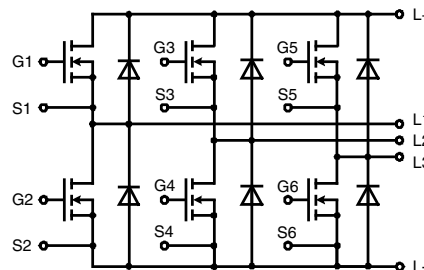

MOSFETs			
Symbol	Conditions	Maximum Ratings	
V_{DSS}	$T_{VJ} = 25^{\circ}\text{C to } 150^{\circ}\text{C}$	75	V
V_{GS}		± 20	V
I_{D25}	$T_C = 25^{\circ}\text{C}$	125	A
I_{D90}	$T_C = 90^{\circ}\text{C}$	90	A
I_{F25}	$T_C = 25^{\circ}\text{C (diode)}$	130	A
I_{F90}	$T_C = 90^{\circ}\text{C (diode)}$	85	A

Applications

AC drives

- in automobiles
 - electric power steering
 - starter generator
- in industrial vehicles
 - propulsion drives
 - fork lift drives
- in battery supplied equipment

Features

- MOSFETs in trench technology:
 - low R_{DSon}
 - optimized intrinsic reverse diode
- package:
 - high level of integration
 - high current capability 300 A max.
 - aux. terminals for MOSFET control
 - terminals for soldering or welding connections
 - isolated DCB ceramic base plate with optimized heat transfer
- Space and weight savings

Symbol	Conditions	Characteristic Values			
		$(T_{VJ} = 25^{\circ}\text{C, unless otherwise specified})$			
		min.	typ.	max.	
R_{DSon}	on chip level at $V_{GS} = 10 \text{ V}; I_D = 60 \text{ A}$		3.7	5.5	$\text{m}\Omega$
			8.4		$\text{m}\Omega$
$V_{GS(th)}$	$V_{DS} = 20 \text{ V}; I_D = 1 \text{ mA}$	2		4	V
I_{DSS}	$V_{DS} = V_{DSS}; V_{GS} = 0 \text{ V}$		0.1	1	μA
I_{GSS}	$V_{GS} = \pm 20 \text{ V}; V_{DS} = 0 \text{ V}$			0.2	μA
Q_g	$V_{GS} = 10 \text{ V}; V_{DS} = 55 \text{ V}; I_D = 125 \text{ A}$		100		nC
Q_{gs}			19		nC
Q_{gd}			28		nC
$t_{d(on)}$	$V_{GS} = 10 \text{ V}; V_{DS} = 30 \text{ V}$ $I_D = 80 \text{ A}; R_G = 39 \Omega$ inductive load		80		ns
t_r			80		ns
$t_{d(off)}$			510		ns
t_f			100		ns
E_{on}			0.12		mJ
E_{off}			0.40		mJ
E_{recoff}		0.02		mJ	
R_{thJC}			0.9		K/W
R_{thJH}	with heat transfer paste		1.2		K/W

Package options

- 3 lead forms available
 - straight leads (SL)
 - SMD lead version (SMD)
 - bent leads (BL)

Source-Drain Diode

Symbol	Conditions	Characteristic Values			
		min.	typ.	max.	
($T_J = 25^\circ\text{C}$, unless otherwise specified)					
V_{SD}	(diode) $I_F = 60\text{ A}$; $V_{GS} = 0\text{ V}$		0.9	1.2	V
t_{rr}			70		ns
Q_{RM}	$I_F = 80\text{ A}$; $-di_F/dt = 800\text{ A}/\mu\text{s}$; $V_R = 30\text{ V}$		1.1		μC
I_{RM}			30		A

Component

Symbol	Conditions	Maximum Ratings	
I_{RMS}	per pin in main current paths (P+, N-, L1, L2, L3) may be additionally limited by external connections	300	A
T_{VJ}		-55...+175	$^\circ\text{C}$
T_{stg}		-55...+125	$^\circ\text{C}$
V_{ISOL}	$I_{ISOL} \leq 1\text{ mA}$, 50/60 Hz, $f = 1\text{ minute}$	1000	V~
F_C	mounting force with clip	50 - 250	N

Symbol	Conditions	Characteristic Values			
		min.	typ.	max.	
$R_{pin\ to\ chip}$	with heatsink compound		0.6		$\text{m}\Omega$
C_p	coupling capacity between shorted pins and mounting tab in the case		160		pF
Weight	typ.		25		g

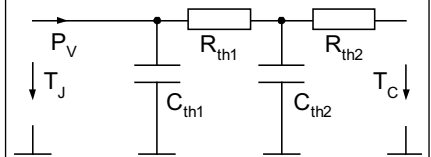
Equivalent Circuits for Simulation
Thermal Response

junction - case (typ.)

$$C_{th1} = 0.039\text{ J/K}; R_{th1} = 0.28\text{ K/W}$$

$$C_{th2} = 0.069\text{ J/K}; R_{th2} = 0.57\text{ K/W}$$

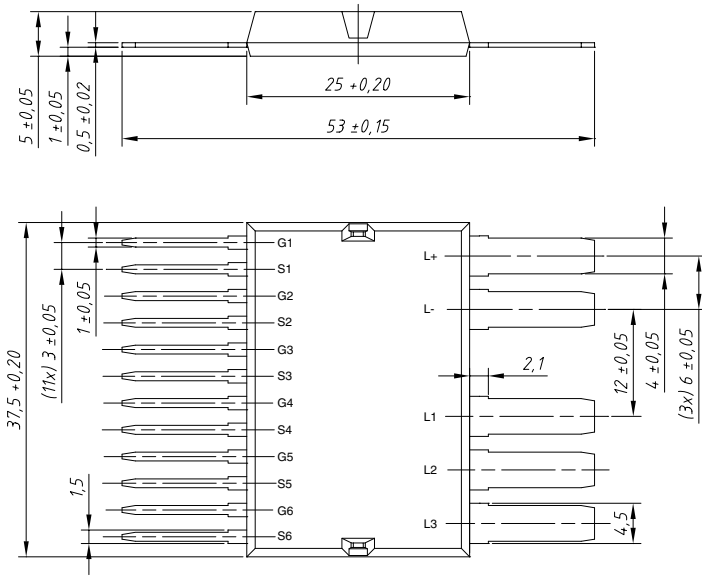
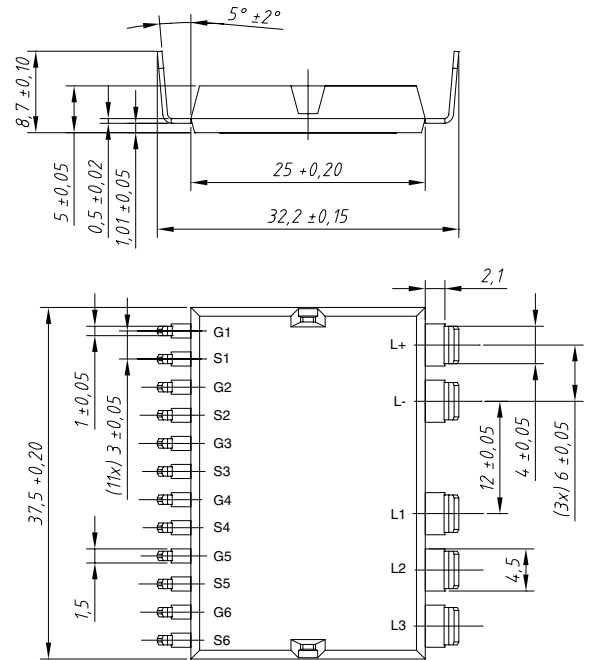
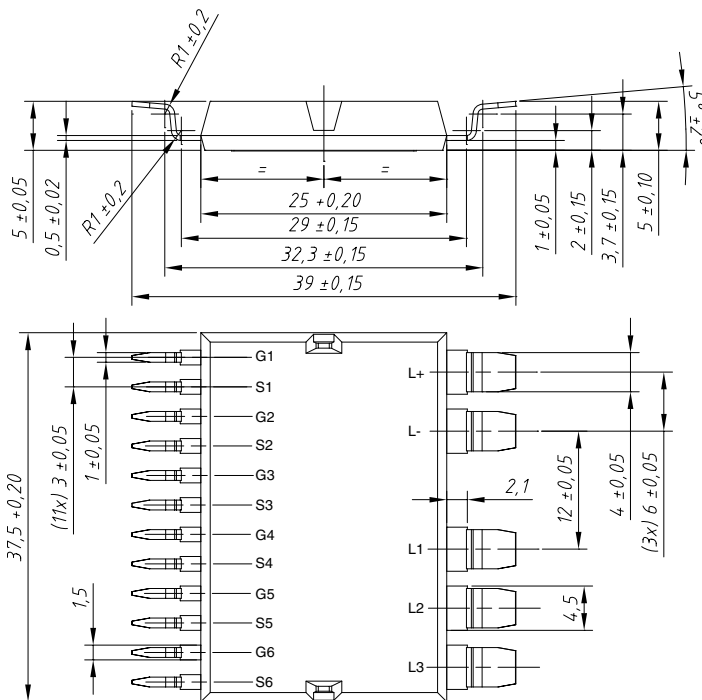
Straight Leads GWM 120-0075P3-SL

Bent Leads GWM 120-0075P3-BL

Surface Mount Device GWM 120-0075P3-SMD

Leads	Ordering	Part Name & Packing Unit Marking	Part Marking	Delivering Mode	Base Qty.	Ordering Code
Straight	Standard	GWM 120-0075P3 - SL	GWM 120-0075P3	Blister	36	502 843
SMD	Standard	GWM 120-0075P3 - SMD	GWM 120-0075P3	Blister	36	502 850
Bent	Standard	GWM 120-0075P3 - BL	GWM 120-0075P3	Blister	36	contact factory

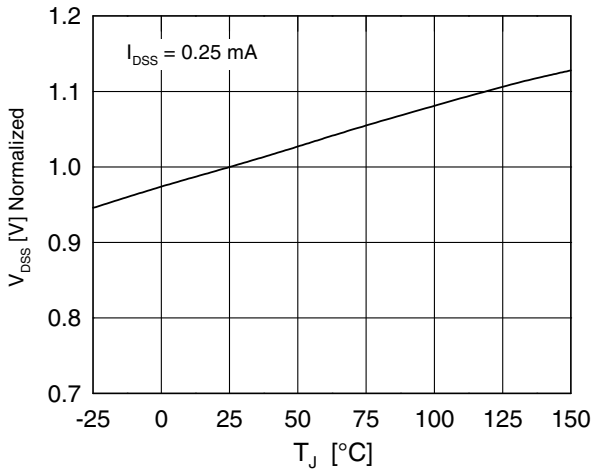

Fig. 1 Drain source breakdown voltage V_{DSS} vs. junction temperature T_{J}

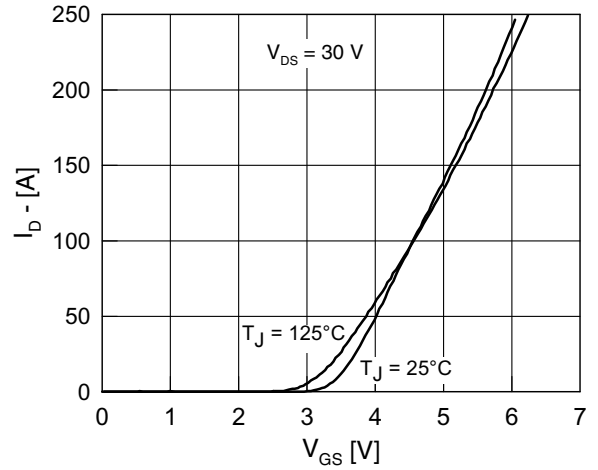

Fig. 2 Typical transfer characteristic

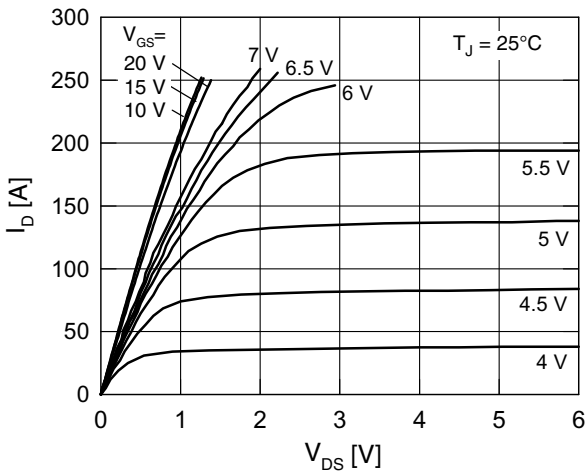

Fig. 3 Typical output characteristic

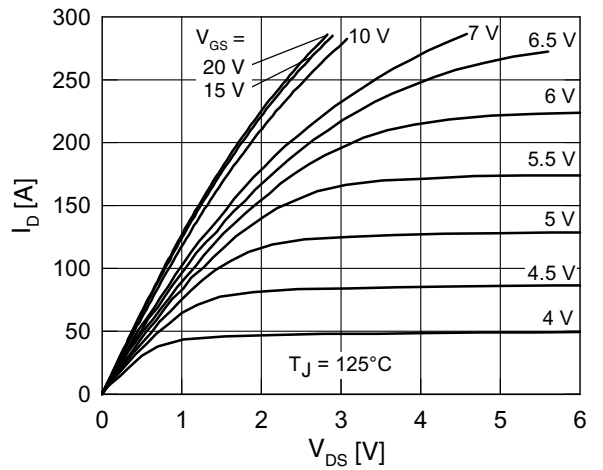

Fig. 4 Typical output characteristic

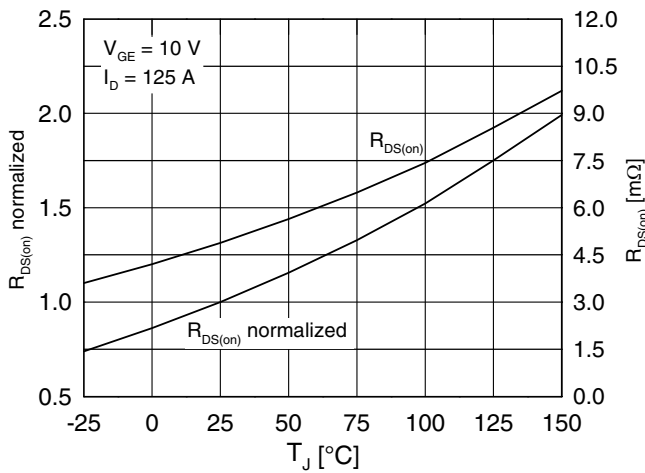

Fig. 5 Drain source on-state resistance $R_{DS(on)}$ versus junction temperature T_J

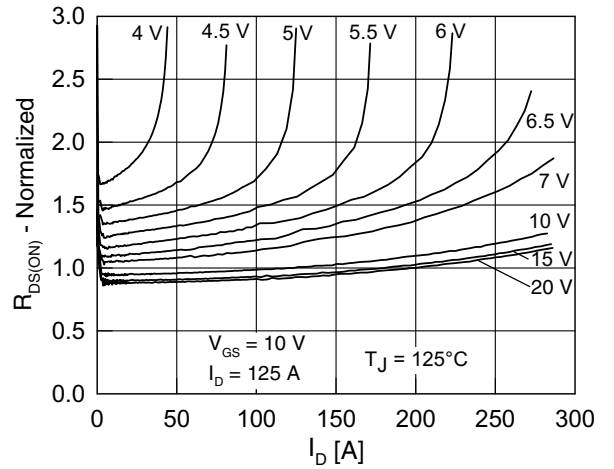

Fig. 6 Drain source on-state resistance $R_{DS(on)}$ versus I_D

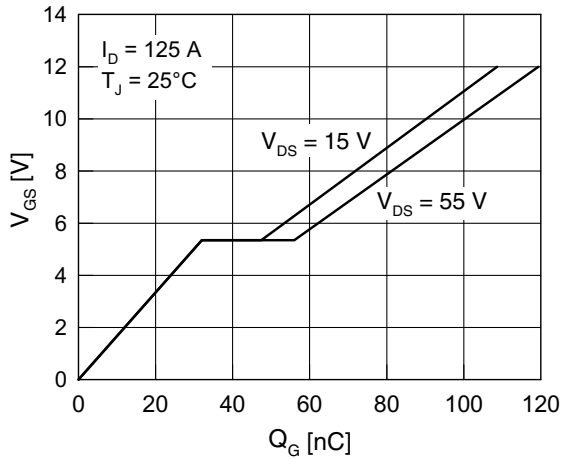

Fig. 7 Gate charge characteristic

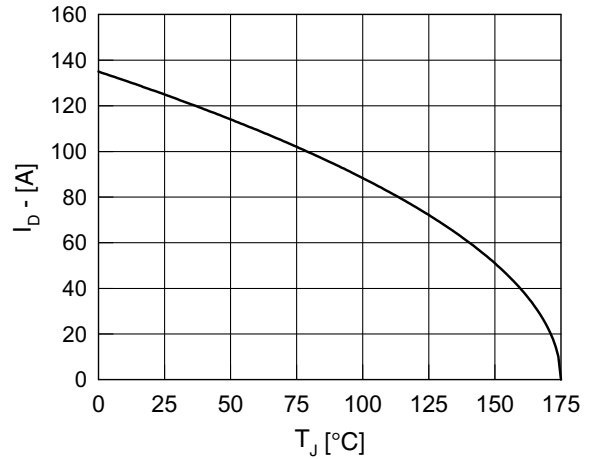

Fig. 8 Drain current I_D vs. case temperature T_C

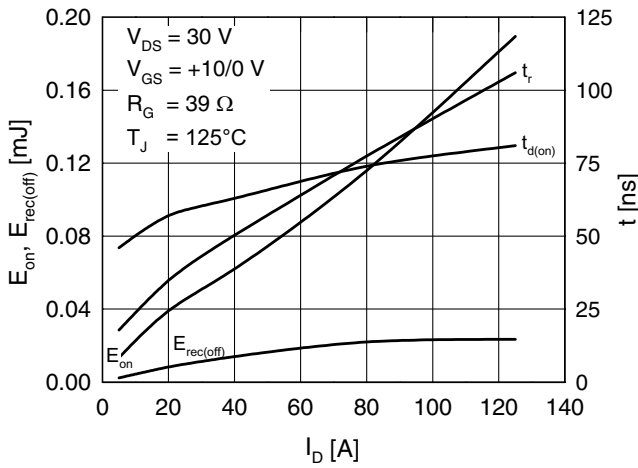

Fig. 9 Typ. turn-on energy & switching times vs. collector current, inductive switching

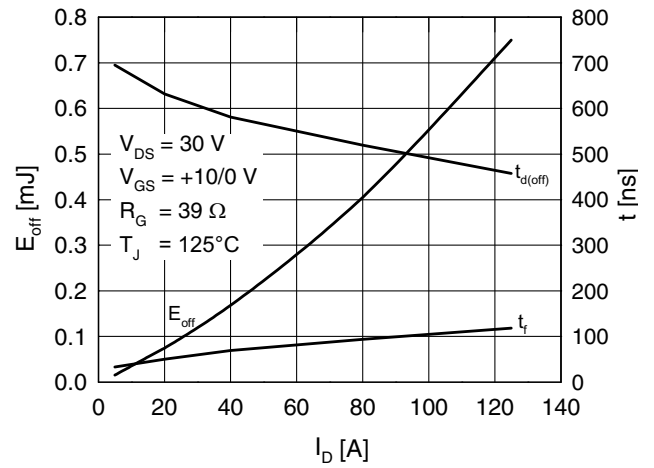

Fig. 10 Typ. turn-off energy & switching times vs. collector current, inductive switching

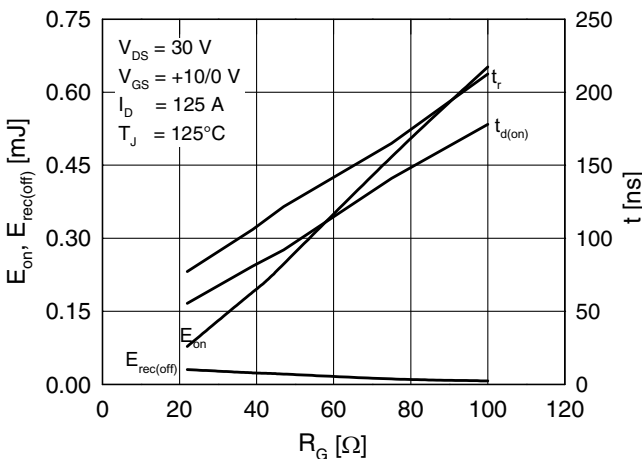

Fig. 11 Typ. turn-on energy & switching times vs. gate resistor, inductive switching

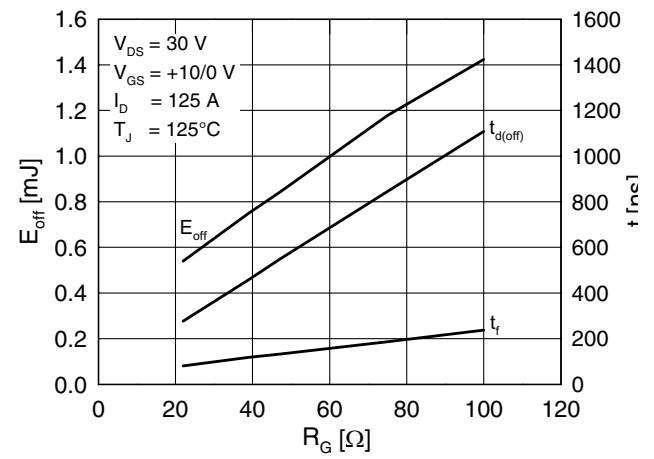

Fig. 12 Typ. turn-off energy & switching times vs. gate resistor, inductive switching

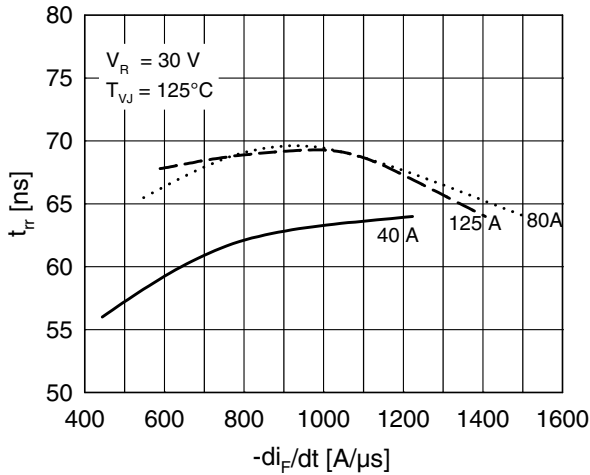

Fig. 13 Reverse recovery time t_{rr} of the body diode vs. di/dt

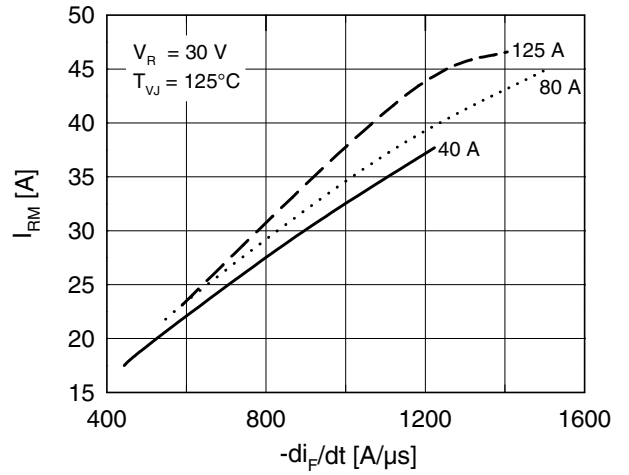

Fig. 14 Reverse recovery current I_{RRM} of the body diode vs. di/dt

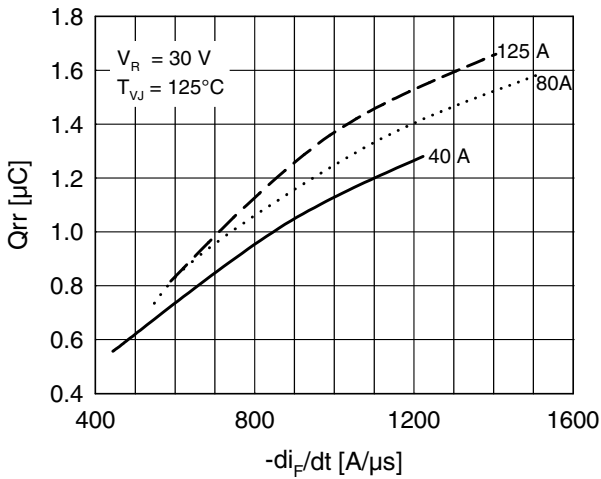

Fig. 15 Reverse recovery charge Q_{rr} of the body diode vs. di/dt

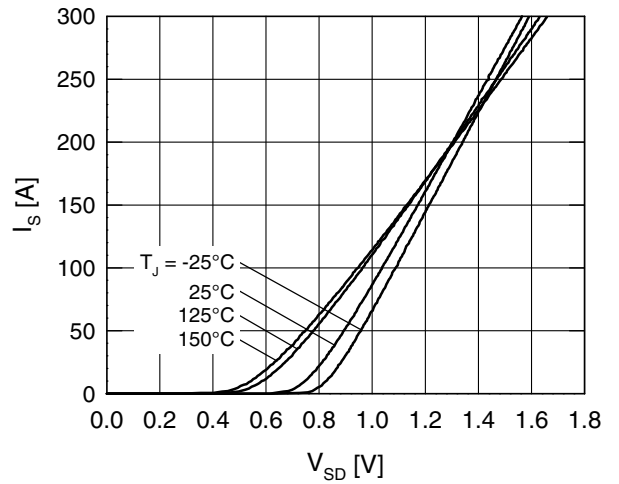

Fig. 16 Source current I_S vs. source drain voltage V_{SD} (body diode)

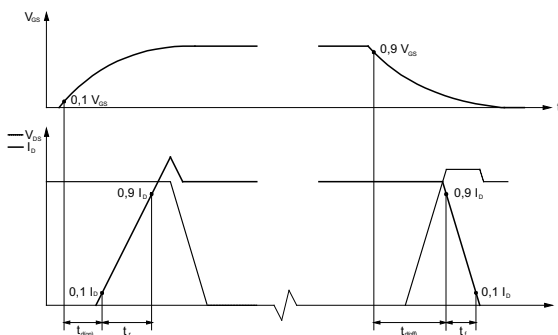

Fig. 17 Definition of switching times

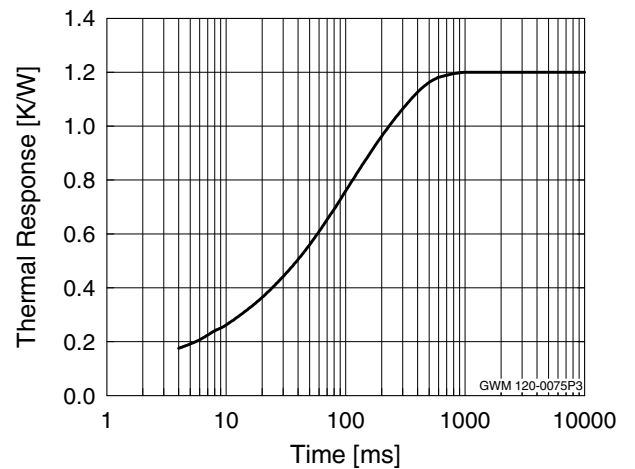

Fig. 18 Typ. therm. impedance junction to heatsink Z_{thJC}