

# Antenna

# YG0005AA Datasheet

## Antenna Services

Version: 1.2

Date: 2021-02-26

Status: Released

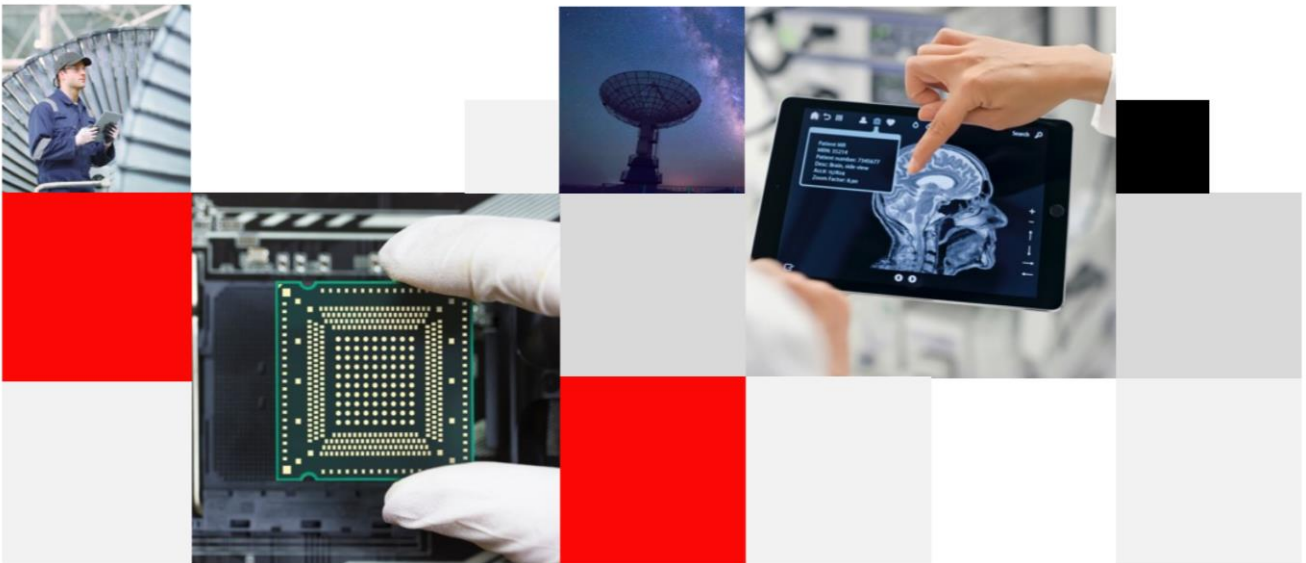

Build a Smarter World

**Our aim is to provide customers with timely and comprehensive service. For any assistance, please contact our company headquarters:**

**Quectel Wireless Solutions Co., Ltd.**

Building 5, Shanghai Business Park Phase III (Area B), No.1016 Tianlin Road, Minhang District, Shanghai 200233, China

Tel: +86 21 5108 6236

Email: [info@quectel.com](mailto:info@quectel.com)

**Or our local office. For more information, please visit:**

<http://www.quectel.com/support/sales.htm>.

**For technical support, or to report documentation errors, please visit:**

<http://www.quectel.com/support/technical.htm>

Or email to [support@quectel.com](mailto:support@quectel.com).

## **General Notes**

Quectel offers the information as a service to its customers. The information provided is based upon customers' requirements. Quectel makes every effort to ensure the quality of the information it makes available. Quectel does not make any warranty as to the information contained herein, and does not accept any liability for any injury, loss or damage of any kind incurred by use of or reliance upon the information. All information supplied herein is subject to change without prior notice.

## **Disclaimer**

While Quectel has made efforts to ensure that the functions and features under development are free from errors, it is possible that these functions and features could contain errors, inaccuracies and omissions. Unless otherwise provided by valid agreement, Quectel makes no warranties of any kind, implied or express, with respect to the use of features and functions under development. To the maximum extent permitted by law, Quectel excludes all liability for any loss or damage suffered in connection with the use of the functions and features under development, regardless of whether such loss or damage may have been foreseeable.

## **Duty of Confidentiality**

The Receiving Party shall keep confidential all documentation and information provided by Quectel, except when the specific permission has been granted by Quectel. The Receiving Party shall not access or use Quectel's documentation and information for any purpose except as expressly provided herein. Furthermore, the Receiving Party shall not disclose any of the Quectel's documentation and information to any third party without the prior written consent by Quectel. For any noncompliance to the above requirements, unauthorized use, or other illegal or malicious use of the documentation and information, Quectel will reserve the right to take legal action.

## Copyright

The information contained here is proprietary technical information of Quectel Wireless Solutions Co., Ltd. Transmitting, reproducing, disseminating and editing this document as well as using the content without permission are forbidden. Offenders will be held liable for payment of damages. All rights are reserved in the event of a patent grant or registration of a utility model or design.

***Copyright © Quectel Wireless Solutions Co., Ltd. 2021. All rights reserved.***

# About the Document

## Revision History

Version	Date	Author	Note
-	2020-08-04	Kenny YIN	Creation of the document
1.0	2020-08-04	Kenny YIN	First official release
1.1	2021-01-05	Kenny YIN	Updated the antenna image and size description.
1.2	2021-02-26	Kenny YIN	<ol style="list-style-type: none"><li>1. Updated the pictures (Chapter 2&amp;4.4);</li><li>2. Updated the product size information (Chapter 5);</li><li>3. Added the packaging information (Chapter 6).</li></ol>

## Contents

About the Document.....	3
Contents.....	4
1 Product Description.....	5
2 Product Features .....	5
3 Product Specifications .....	6
4 Overall Performance.....	7
4.1. Test Environment .....	7
4.2. Return Loss (By Test Ground Plane) .....	8
4.3. Measured Input Impedance on a Smith Chart (By Test Ground Plane).....	9
4.4. Test Condition Ground Plane (Unit: mm) .....	10
5. Product Size .....	11
6. Packaging .....	12

## 1 Product Description

The antenna is designed for superior performance, and can be widely used for wireless applications.

We provide comprehensive antenna design support such as simulation, testing and manufacturing for custom antenna solutions to meet your specific application needs.

## 2 Product Features

- GPS L1
- High efficiency
- Excellent performance



### 3 Product Specifications

#### Passive Electrical Specifications

Frequency Range	1600.4 ±3 MHz 1575.42 ±3 MHz	By Test Ground Plane In Customer's Model
Input Impedence	50 Ω	
Return Loss	≤ -20dB	By Test Ground Plane
Gain	-	
Efficiency	-	
Polarization Type	RHCP	

#### Mechanical Specifications

Antenna Size	18.4 mm × 18.4 mm × 4 mm
Casing	Ceramics
Connector Type	-
Working Temperature	-40 °C to +85 °C
Radome Color	-

## 4 Overall Performance

### 4.1. Test Environment

- KEYSIGHT VNA Network Analyzer E5063A 100 kHz – 6.5 GHz
- RayZone®2800 Chamber 5G (FR1) SISO/MIMO, 400 MHz – 6.0 GHz





## 4.2. Return Loss (By Test Ground Plane)

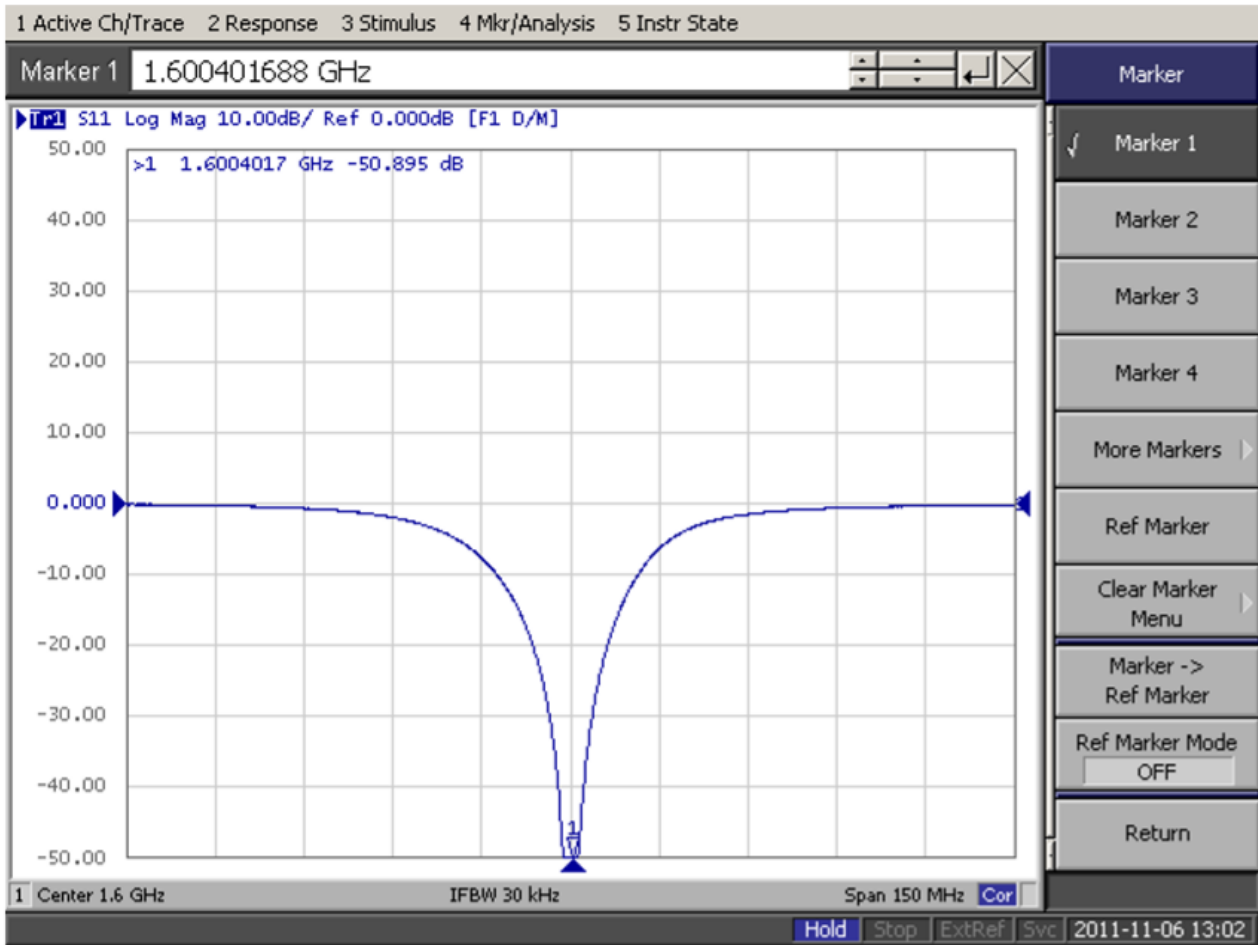

### 4.3. Measured Input Impedance on a Smith Chart (By Test Ground Plane)

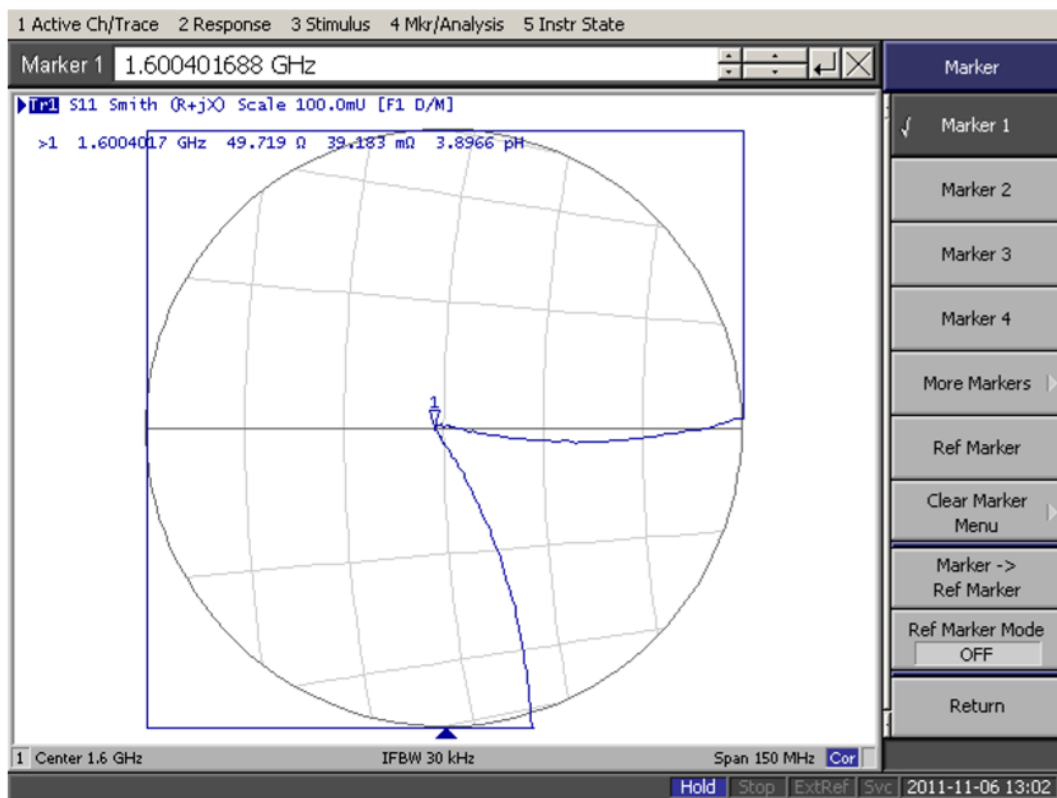
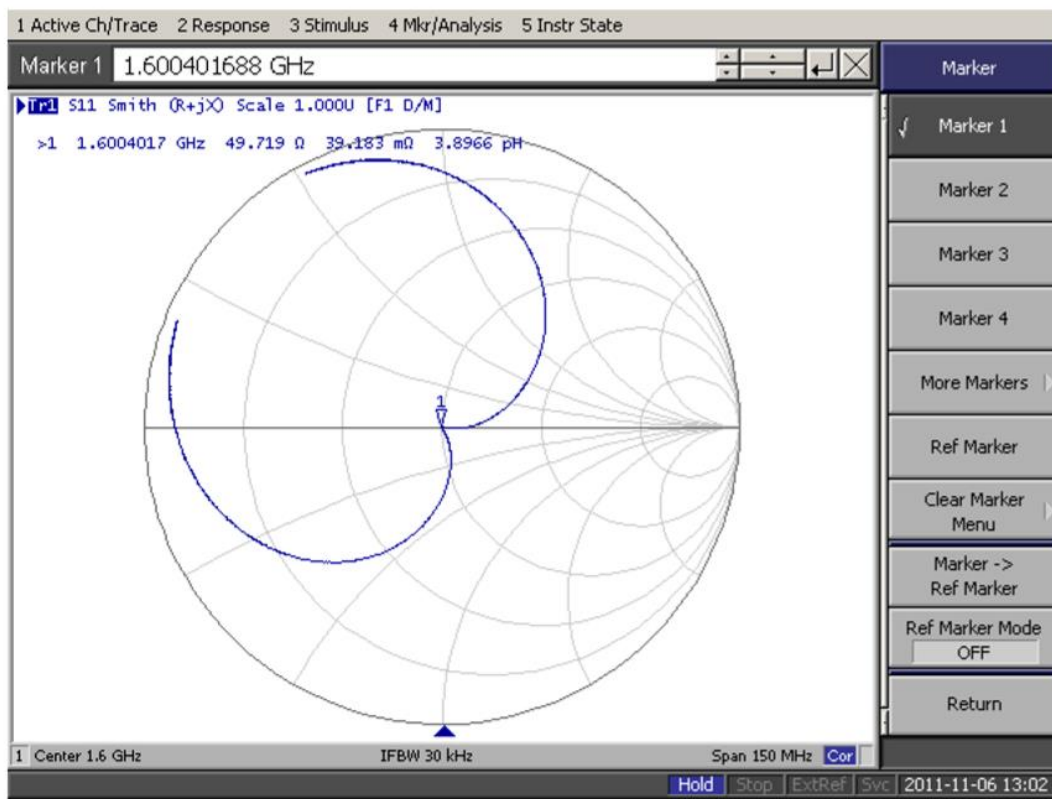

### 4.4. Test Condition Ground Plane (Unit: mm)

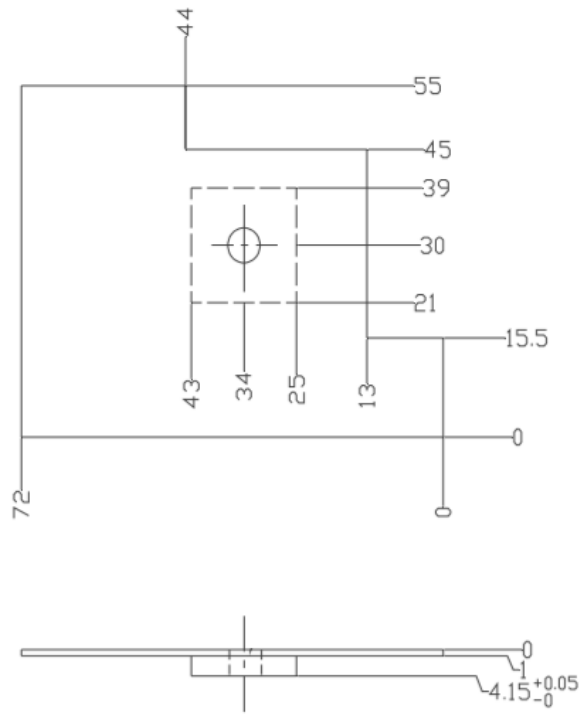

### 5. Product Size

RoHS

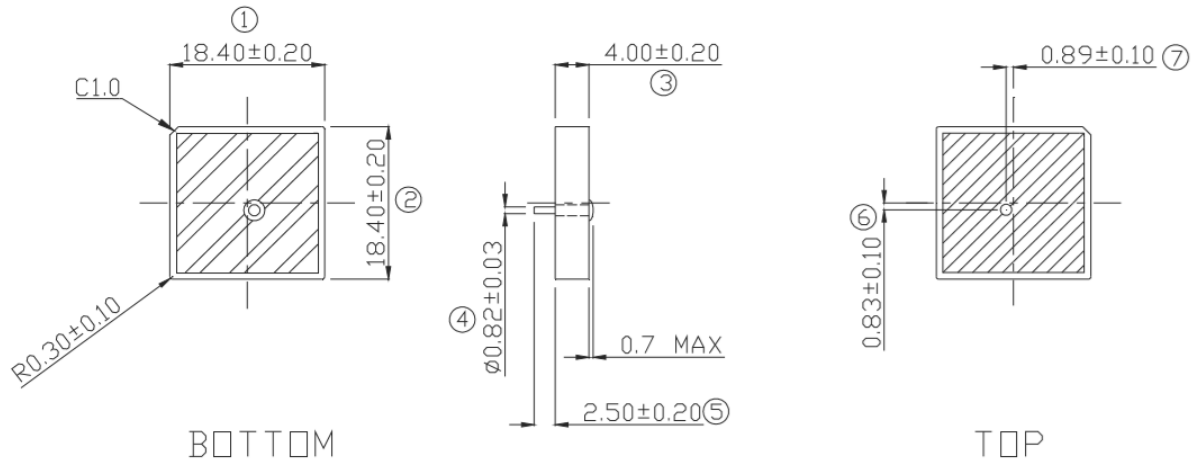

Note: These 1-7 balloons are important dimension

#### Adhesive Tape:

- TAPE: Nitto 5000NS 17 m x 17 m x 0.16 m
- Thickness :  $0.16 \pm 5\%$  mm

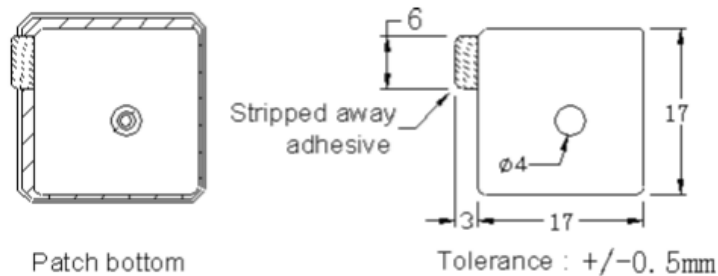

#### Marking:

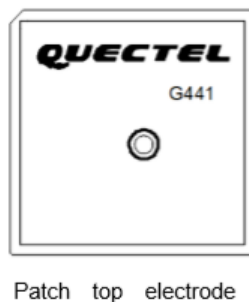

## 6. Packaging

- 50pcs patch/Tray, 250pcs patch/Small box, 1000pcs patch/Carton.
- The packaging steps are as follows:



Step1:  
50pcs patch/Tray,  
Place 1pcs in each cell.  
Tray size:  
208\*208\*24mm



Step4:  
Vacuum sealing.

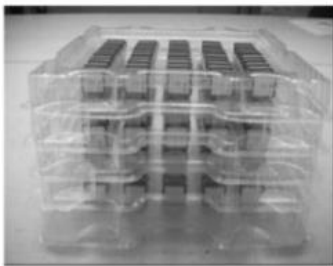

Step2:  
Five trays are staggered.

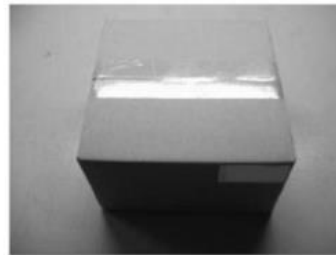

Step5:  
Put the inner box into the partition, and  
then put the sealed 250pcs patch into the  
small box.  
Small box size: 215\*215\*123mm



Step3:  
Place 1 piece of foam on  
the top layer, then pack  
and fix it.



Step6:  
Put four small boxes into the Carton,  
1000pcs patch/Carton.  
Carton size: 450\*240\*290mm