

DETAILS

Product Number	C13232_HB-2X2-WW
Family	High Bay
Type	Lens array
Color	clear
Diameter	50x50 mm
Height	8,5 mm
Style	square
Optic Material	PMMA
Holder Material	
Fastening	screw, pin, glue
Status	production ready
ROHS Compliant	Yes
Date Updated	21/04/2016



OPTICAL PROPERTIES

LED	Viewing Angle	Light Beam	Efficiency	cd/lm	Connector
XT-E	65 deg	Wide	91 %	0.900	-
XP-G2	69 deg	Wide	91 %	0.700	-
XP-G	69 deg	Wide	91 %	0.800	-
H35C1 (LEMWA33)	68 deg	Wide	89 %	0.800	-
LUXEON Z ES	59 deg	Wide	90 %	1.000	-
LUXEON Q	67 deg	Wide	91 %	0.800	-
NVSxx19B/NVSxx19C	67 deg	Wide	91 %	0.800	-
Oslon Square PC	63 deg	Wide	91 %	0.863	-
Oslon SSL 80	54 deg	Wide	92 %	1.080	-
Oslon Square Gen3	sim: 69	Wide	sim: 94 %	sim: 1.070	-
LH351A(3535)	68 deg	Wide	92 %	0.800	-
LH351Z	63 deg	Wide	89 %	0.860	-
LH351B	65 deg	Wide	89 %	0.780	-
Z8Y19	56 deg	Wide	85 %	0.880	-
Z8Y15	56 deg	Wide	85 %	0.870	-
TL1L4	60 deg	Wide	84 %	0.870	-
RLE G1 49x223mm 4000lm xxx EXC OT	7 deg	Wide	94 %	0.850	-
RLE G1 49x245mm 4000lm xxx EXC OT	7 deg	Wide	94 %	0.850	-
RLE G1 49x121mm 2000lm xxx EXC OT	7 deg	Wide	94 %	0.850	-
RLE G1 49x133mm 2000lm xxx EXC OT	7 deg	Wide	94 %	0.850	-

D

C

B

A

4

4

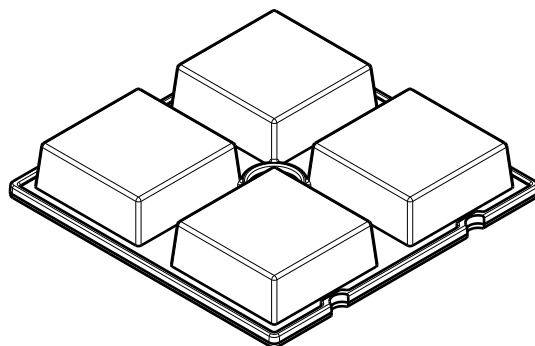
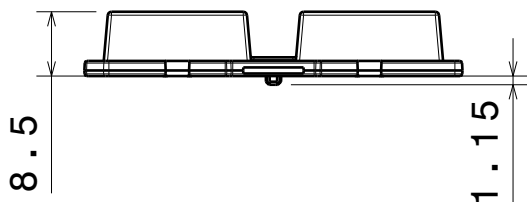

3

3

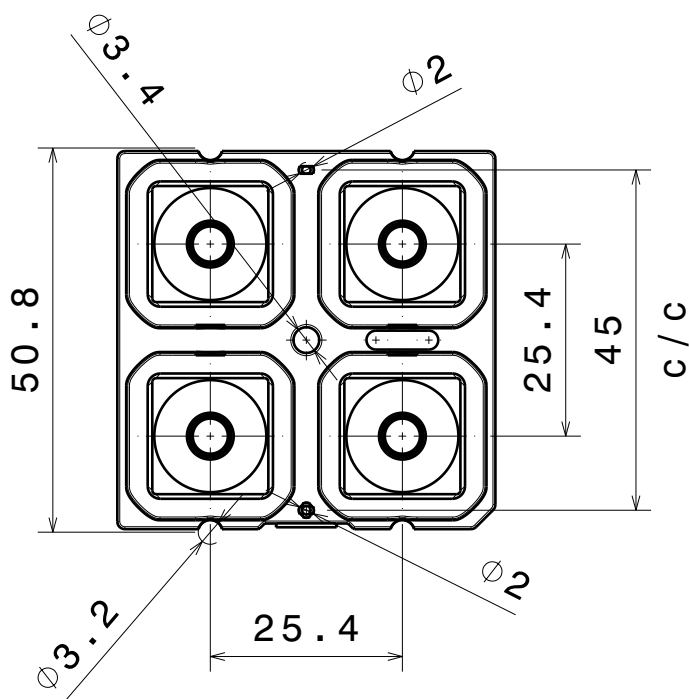
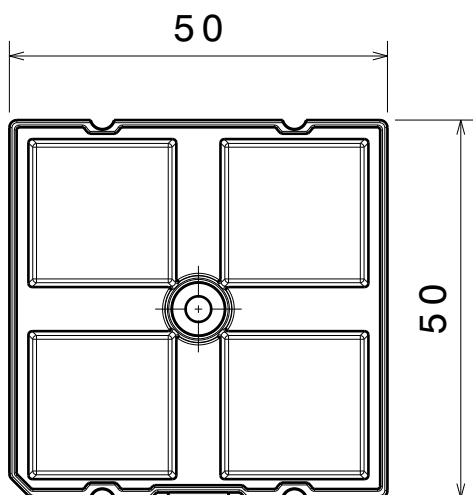

2

2

INDEX	PART NO	DESCRIPTION	MATERIAL	COLOUR
1	C13232	HB-2x2-WW	PMMA	

Tolerances if not otherwise shown
According to DIN ISO 2768-1
Linear measures:
up to 30mm class M, otherwise class C
According to DIN ISO 2768-2
Form and position: class L

LEDiL

Ledil Oy
Salorankatu 10
FIN 24240 SALO
Finland

THIRD ANGLE PROJECTION:

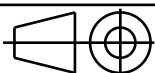

DRAWING TITLE

C13232_HB-2x2-WW

This drawing is the property
of LEDiL Oy. It may not be
reproduced, copied or
communicated without a written
agreement with LEDiL Oy.

SIZE PART NUMBER

A4

C13232

SCALE	1:1	WEIGHT	10,8 g	SHEET	1/1
-------	-----	--------	--------	-------	-----

1

1

D

A

Luminaire: Ledil Oy C13237&C13232_HB-2X2-WW (Cree XT-E 390lm @ 250mA) Efficiency=91%
Lamps: 1 x Cree XT-E 390lm @ 250mA

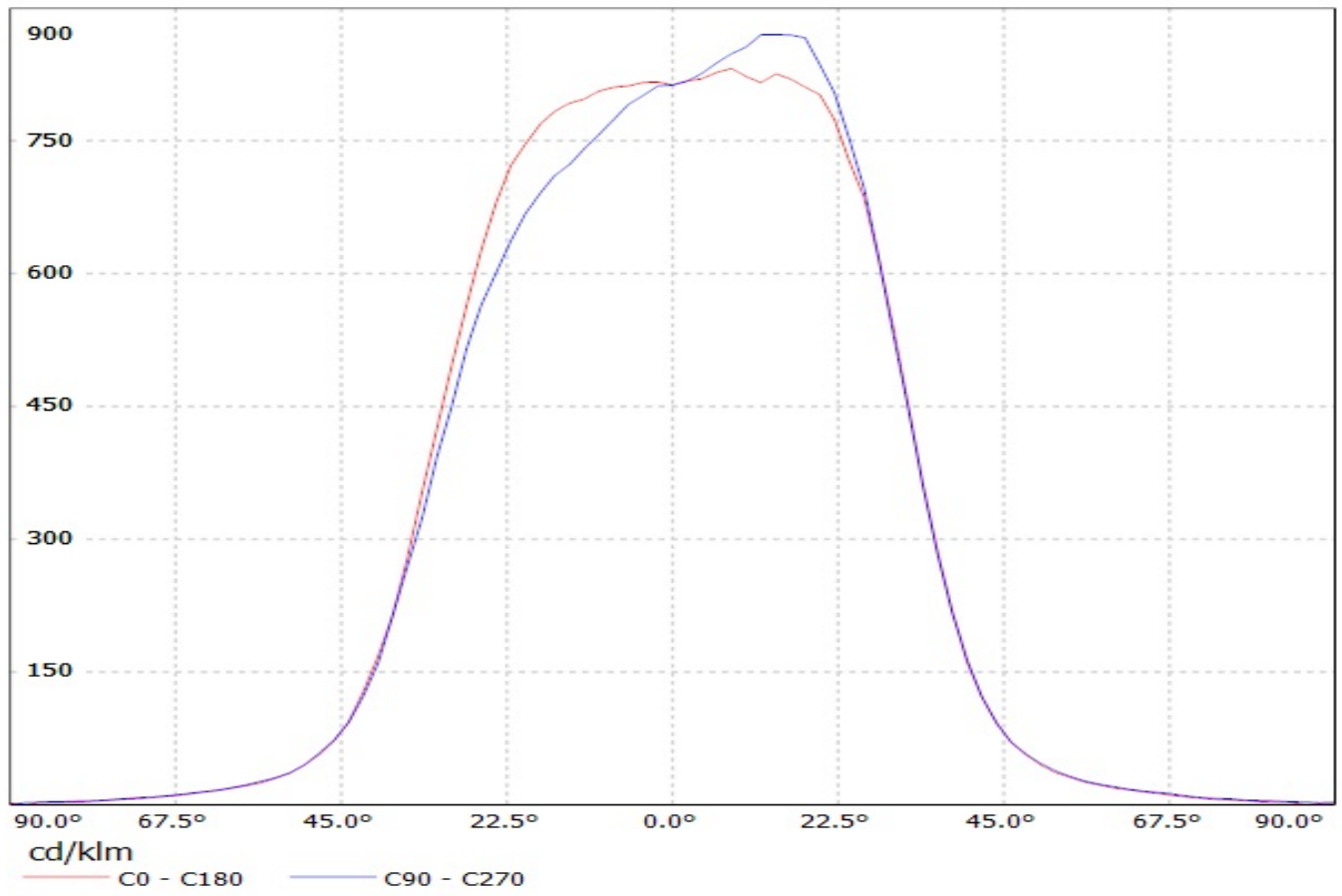

Luminaire: Ledil Oy C13237&C13232_HB-2X2-WW (Cree XP-G2 420lm @ 250mA) Efficiency=91%
Lamps: 1 x Cree XP-G2 420lm @ 250mA

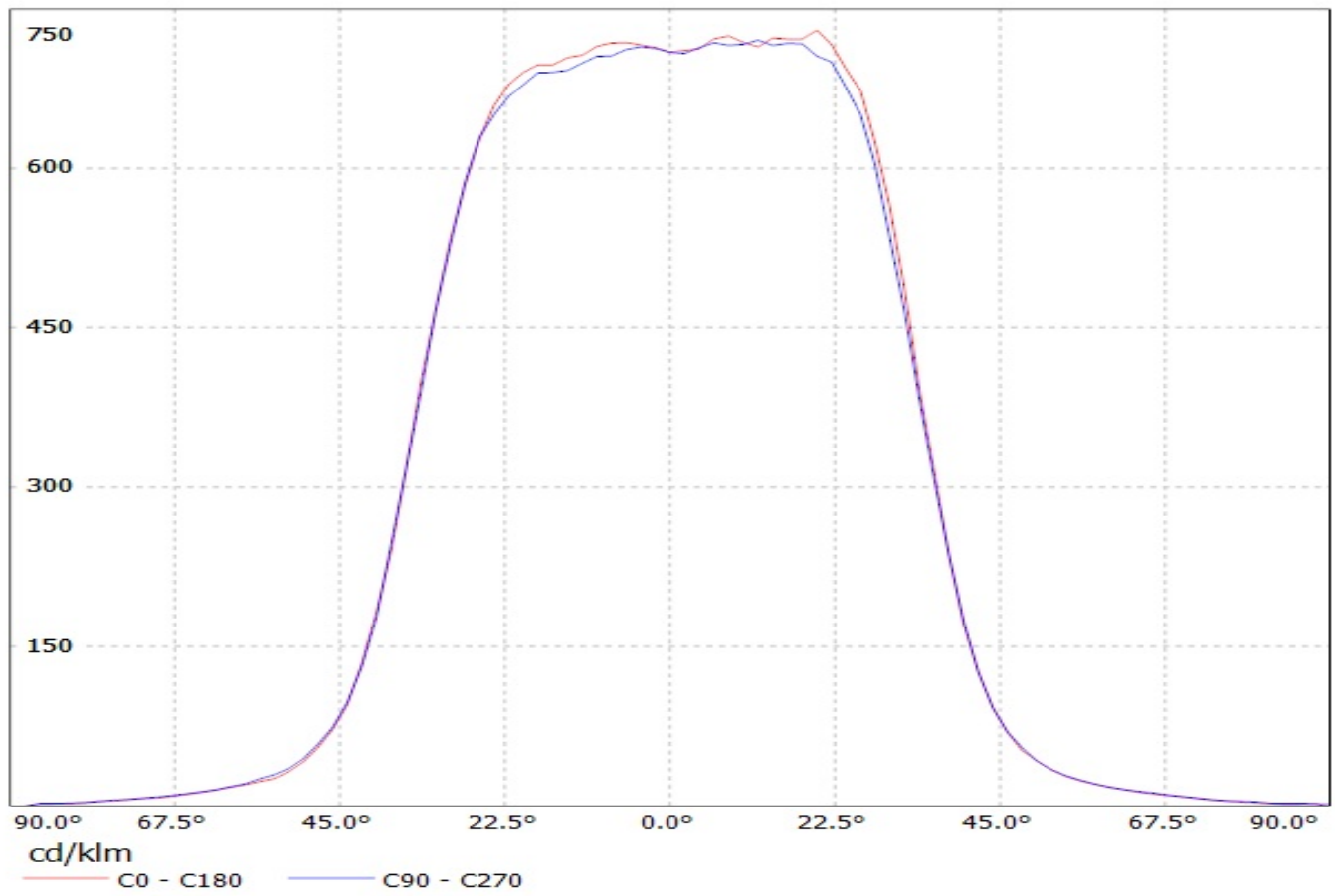

Luminaire: Ledil Oy C13237&C13232_HB-2X2-WW (Cree XP-G 257lm @ 250mA) Efficiency=91%
Lamps: 1 x Cree XP-G 257lm @ 250mA

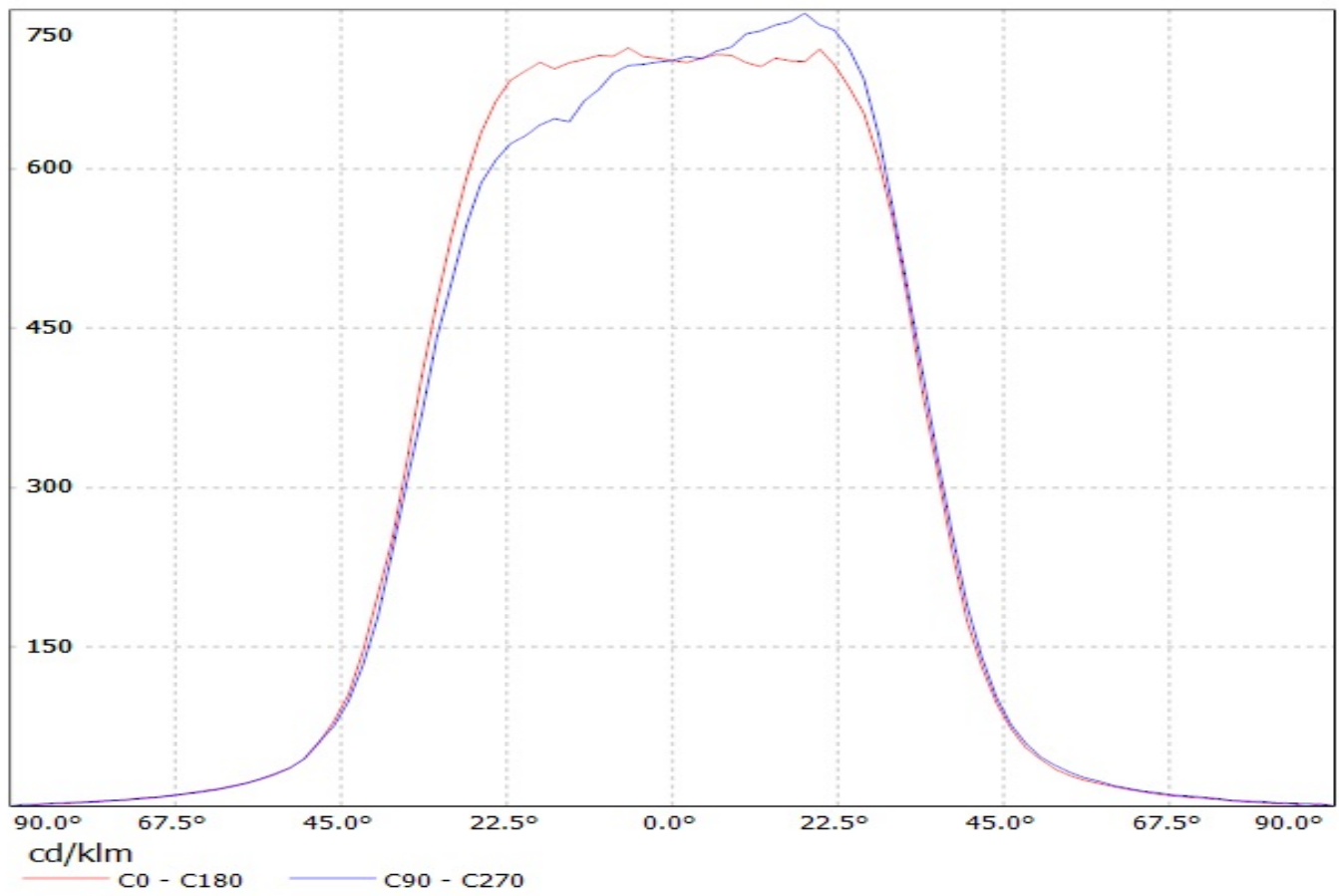

Luminaire: Ledil Oy C13232_HB-2x2-WW_(3535_Ceramic_gen2) Efficiency=89%
Lamps: 1 x LG 3535 Ceramic gen2 (PKG5700K) 461lm @ 250mA CCT=6600K P=2.9W I=250mA

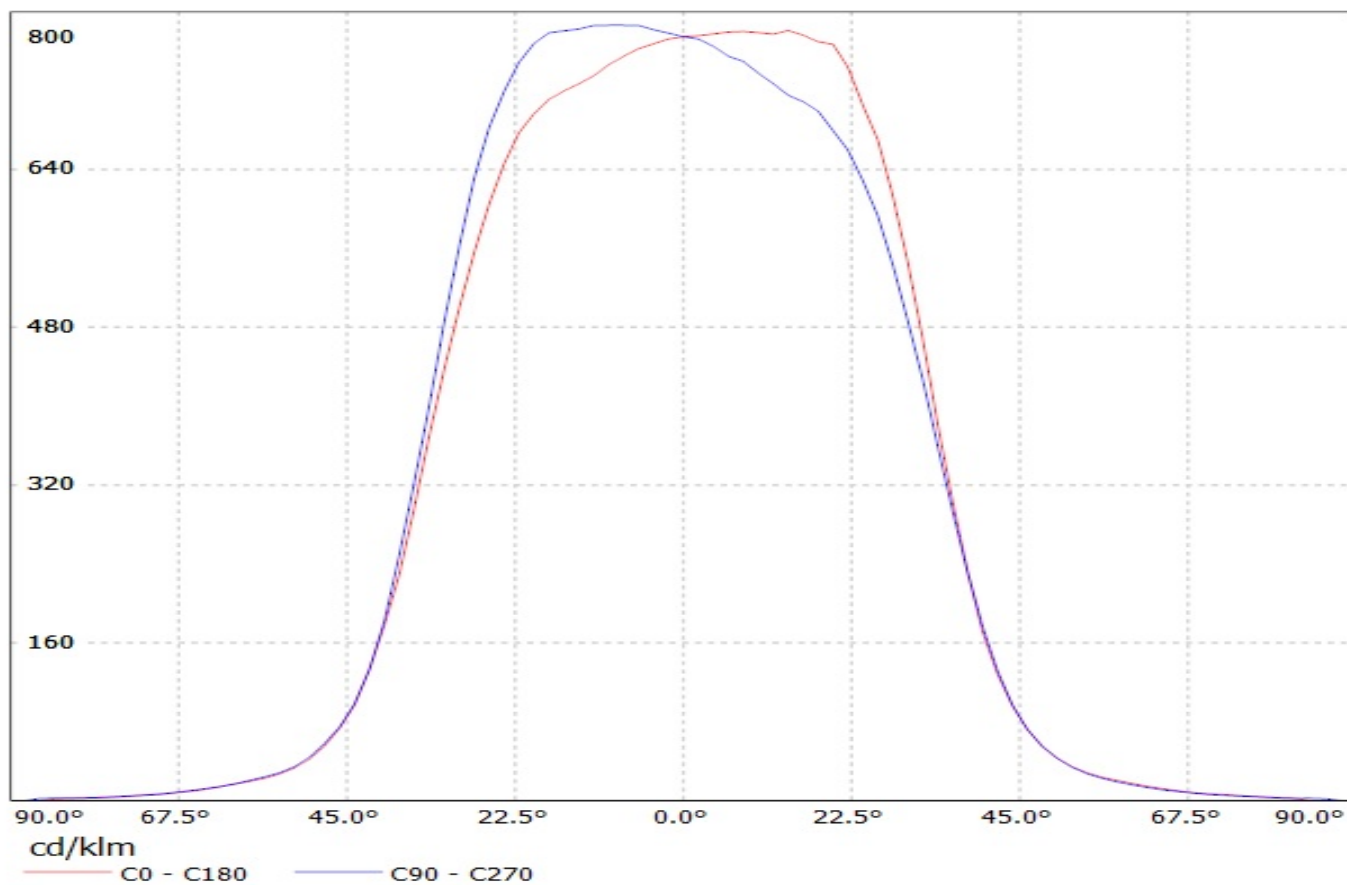

Luminaire: Ledil Oy C13232_HB-2X2-WW_(Luxeon_Z_ES) Efficiency=90%
Lamps: 1 x Luxeon Z ES (LXZ2-3090) 209lm @ 250mA CCT=3000k P=2.8W I=250mA

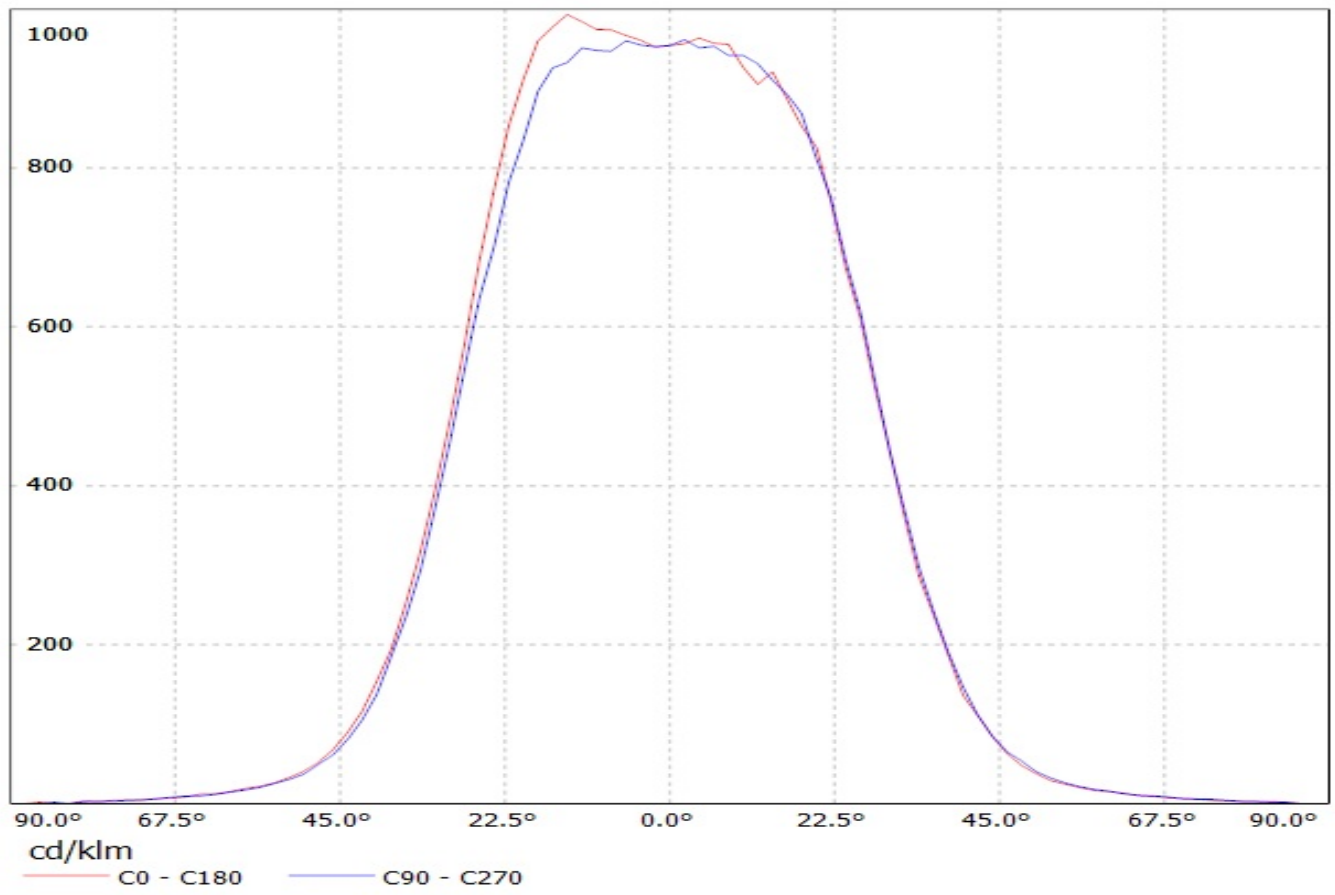

Luminaire: LEDiL Oy C13232_HB-2X2-WW_(LUXEON_Q) Eff.90.8%
Lamps: 1 x LUXEON_Q_2x2_(LHQ-3080)_298.363lm@250mA_P=2.87385W_I=249.9mA

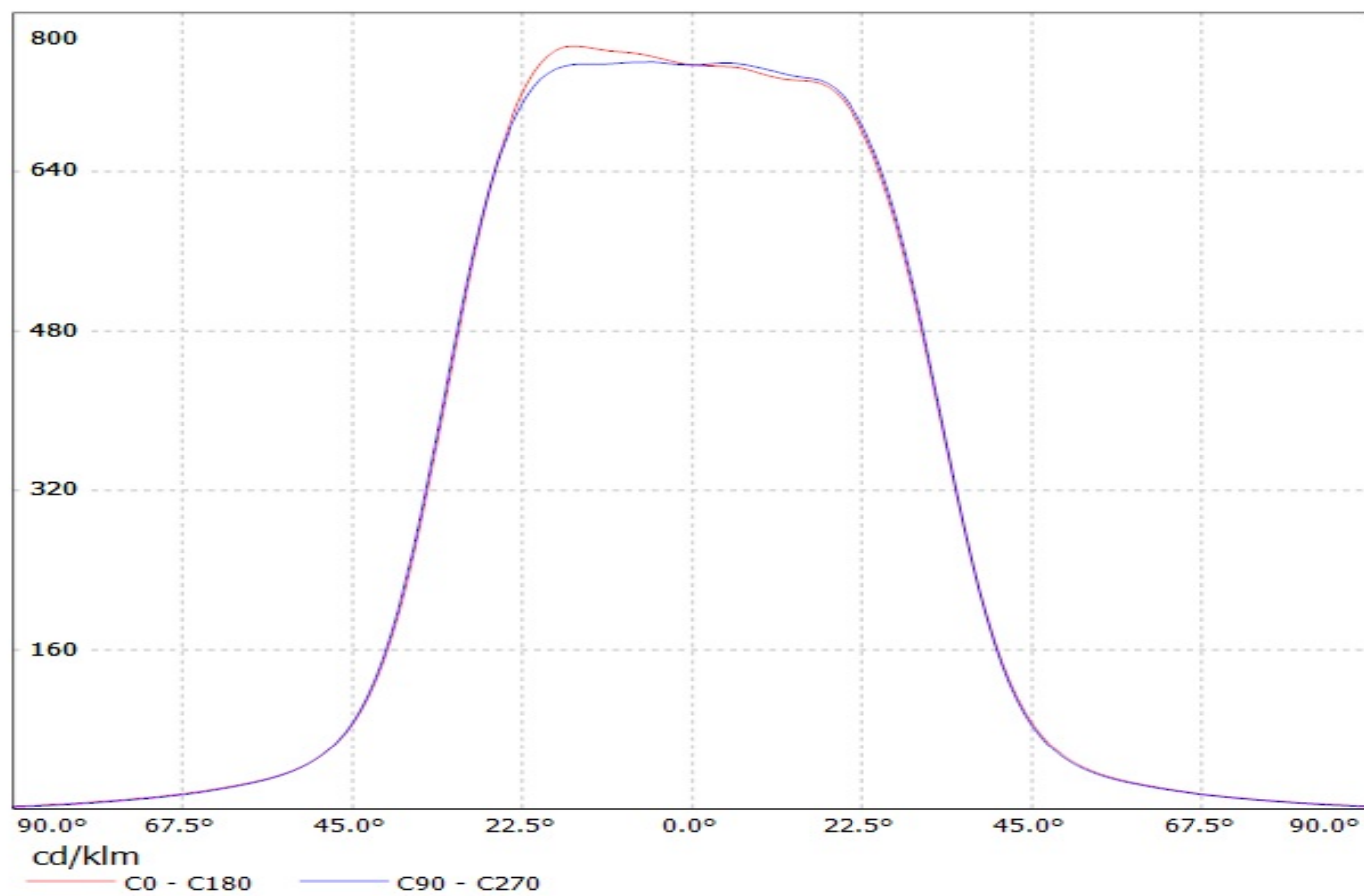

Luminaire: Ledil Oy C13237&C13232_HB-2X2-WW (Nichia NVS19B 306lm @ 250mA) Efficiency=91%
Lamps: 1 x Nichia NVS19B 306lm @ 250mA

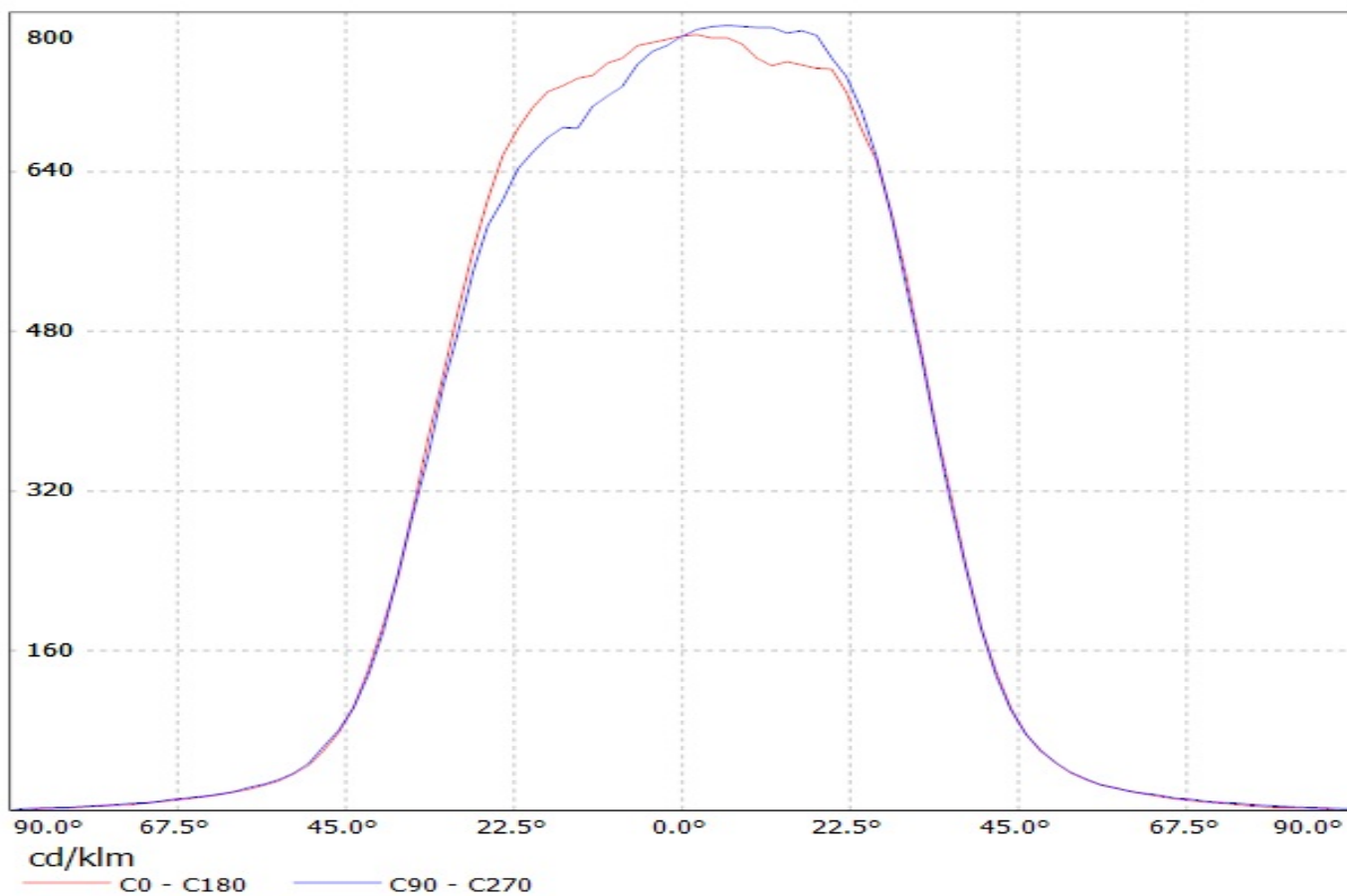

Luminaire: LEDiL Oy C13232_HB-2x2-WW_(Osram_Square_PC) Eff. 91,6%

Lamps: 1 x Osram Square PC (385lm@100mA)

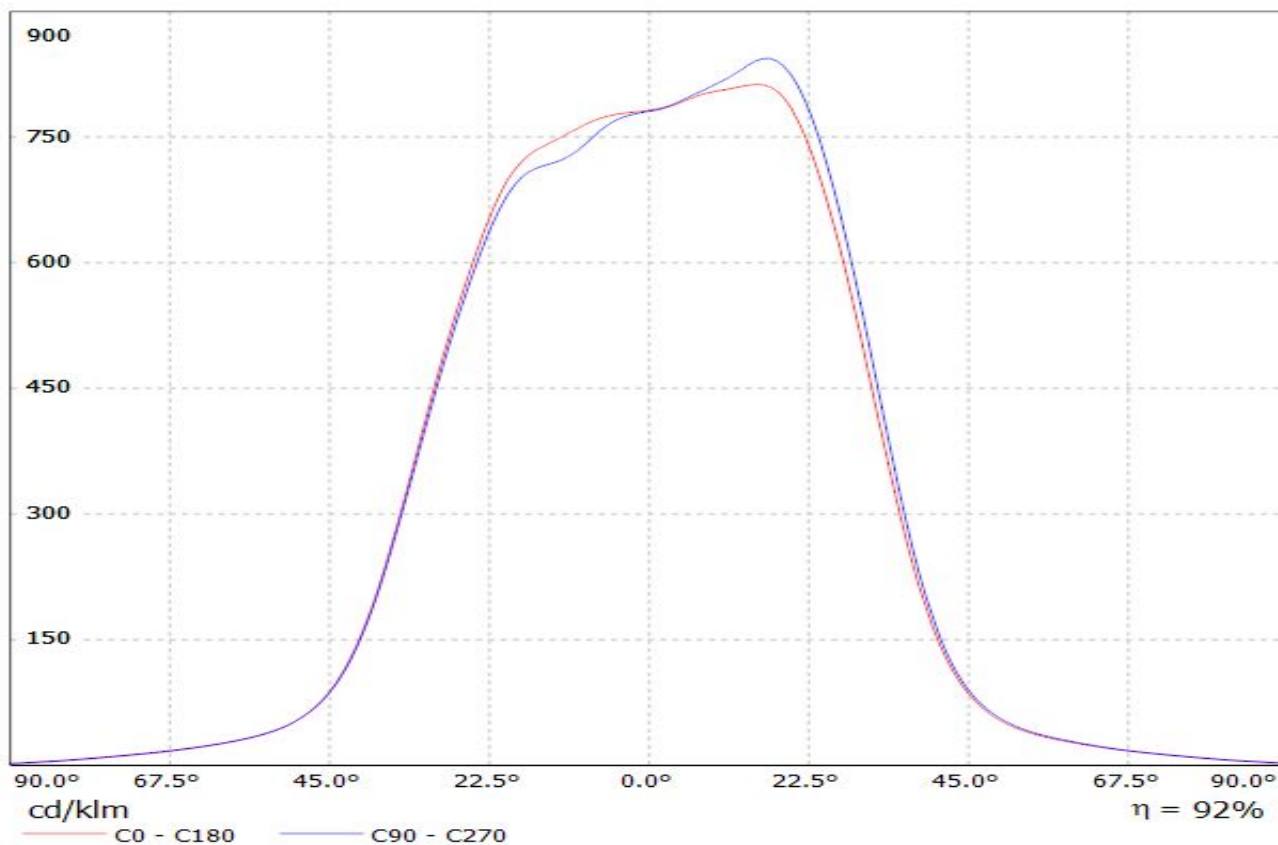

LEDiL Oy C13232_HB-2x2-WW_(SSL80) Eff.91.5% / LDC (Linear)

Luminaire: LEDiL Oy C13232_HB-2x2-WW_(SSL80) Eff.91.5%
Lamps: 1 x Osram Oslon SSL80 (308lm@250mA)

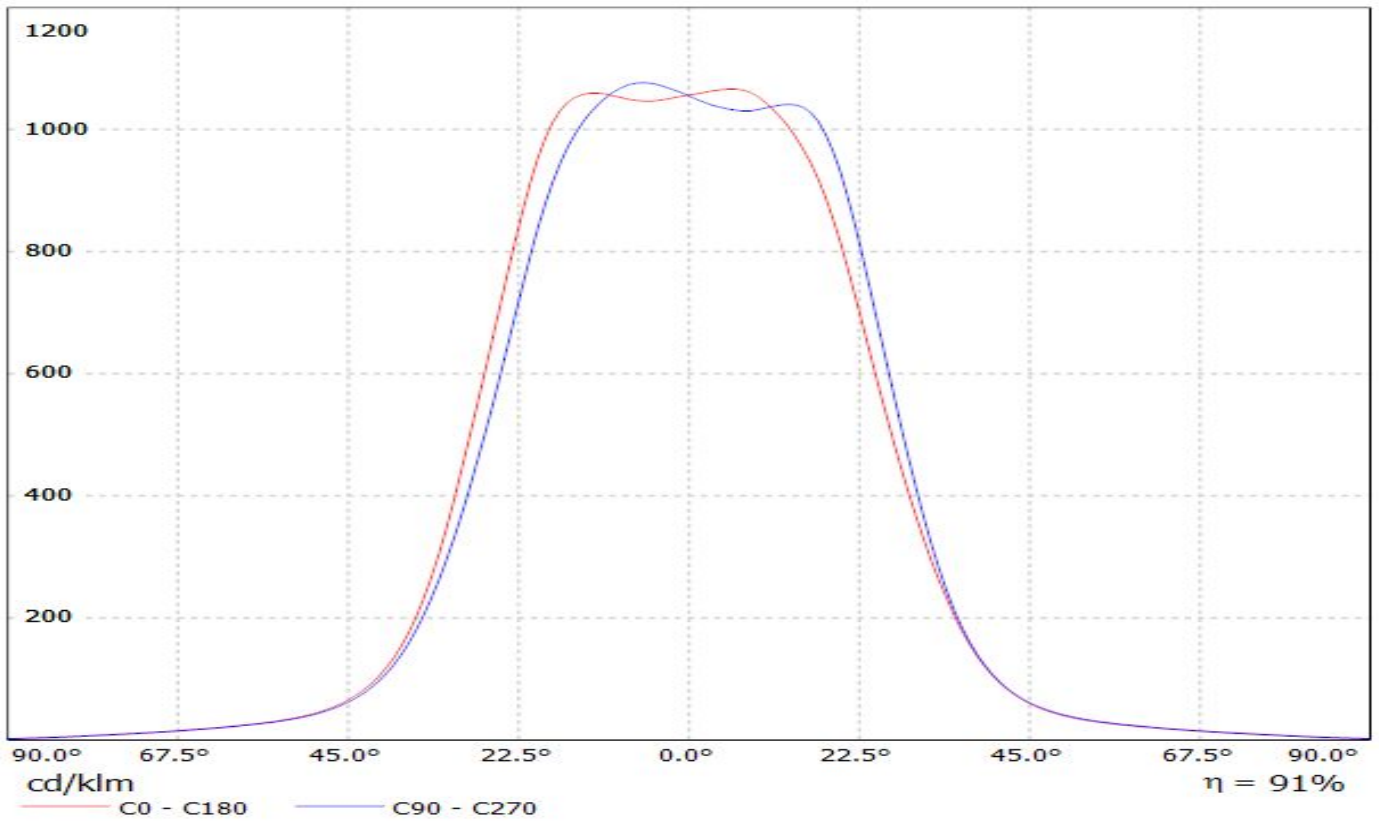

Luminaire: LEDiL Oy C13232_HB-2X2-WW_(LH351Z) Eff.89.0%
Lamps: 1 x SAMSUNG_LH351Z_2x2_359.49lm@250mA_P=2.86371W_I=249.8mA

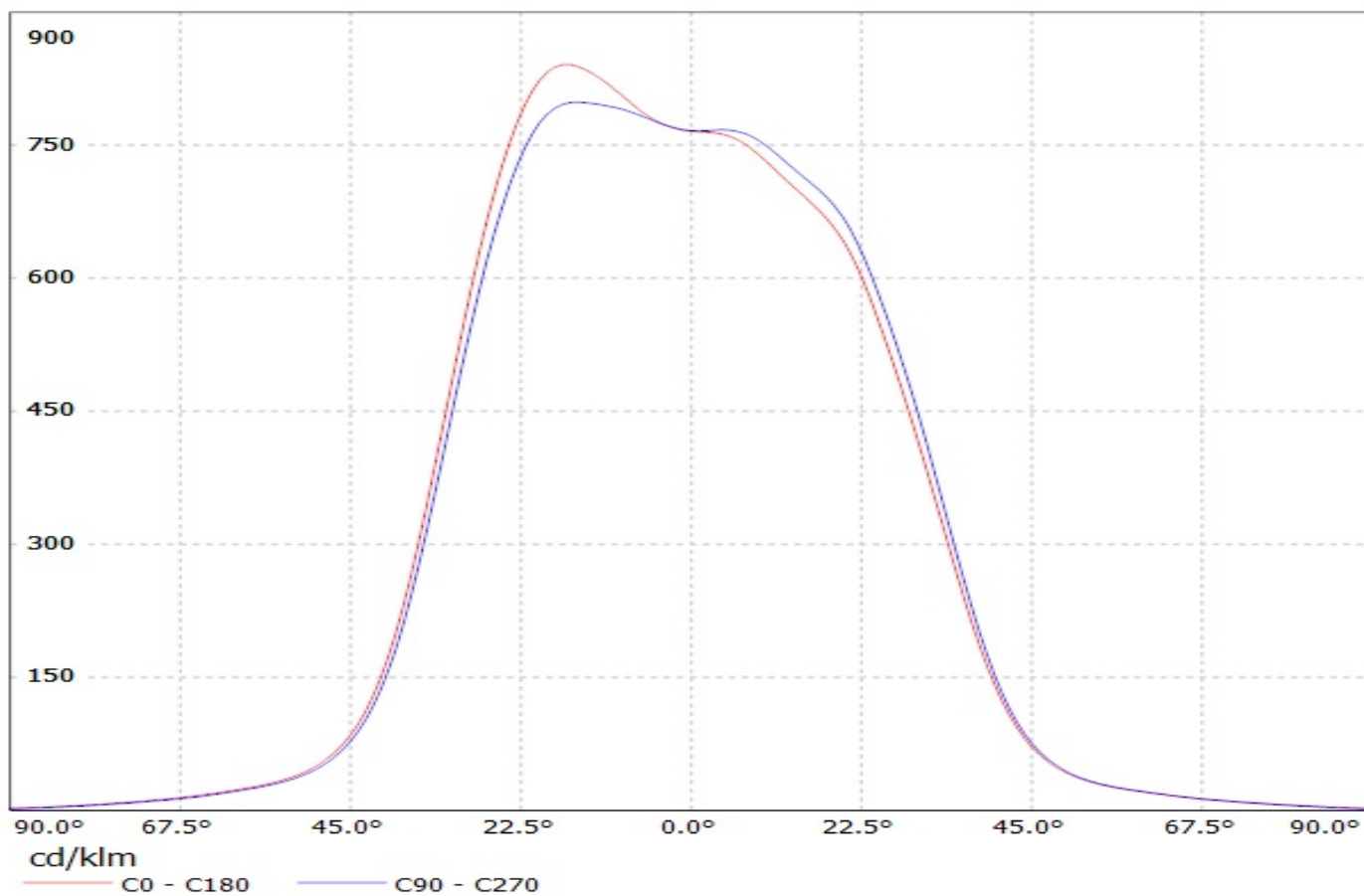

Luminaire: LEDiL Oy C13232_HB-2X2-WW_(LH351B) Eff.88.6%
Lamps: 1 x SAMSUNG_LH351B_2x2_430.715lm@250mA_P=2.84311W_I=249.9mA

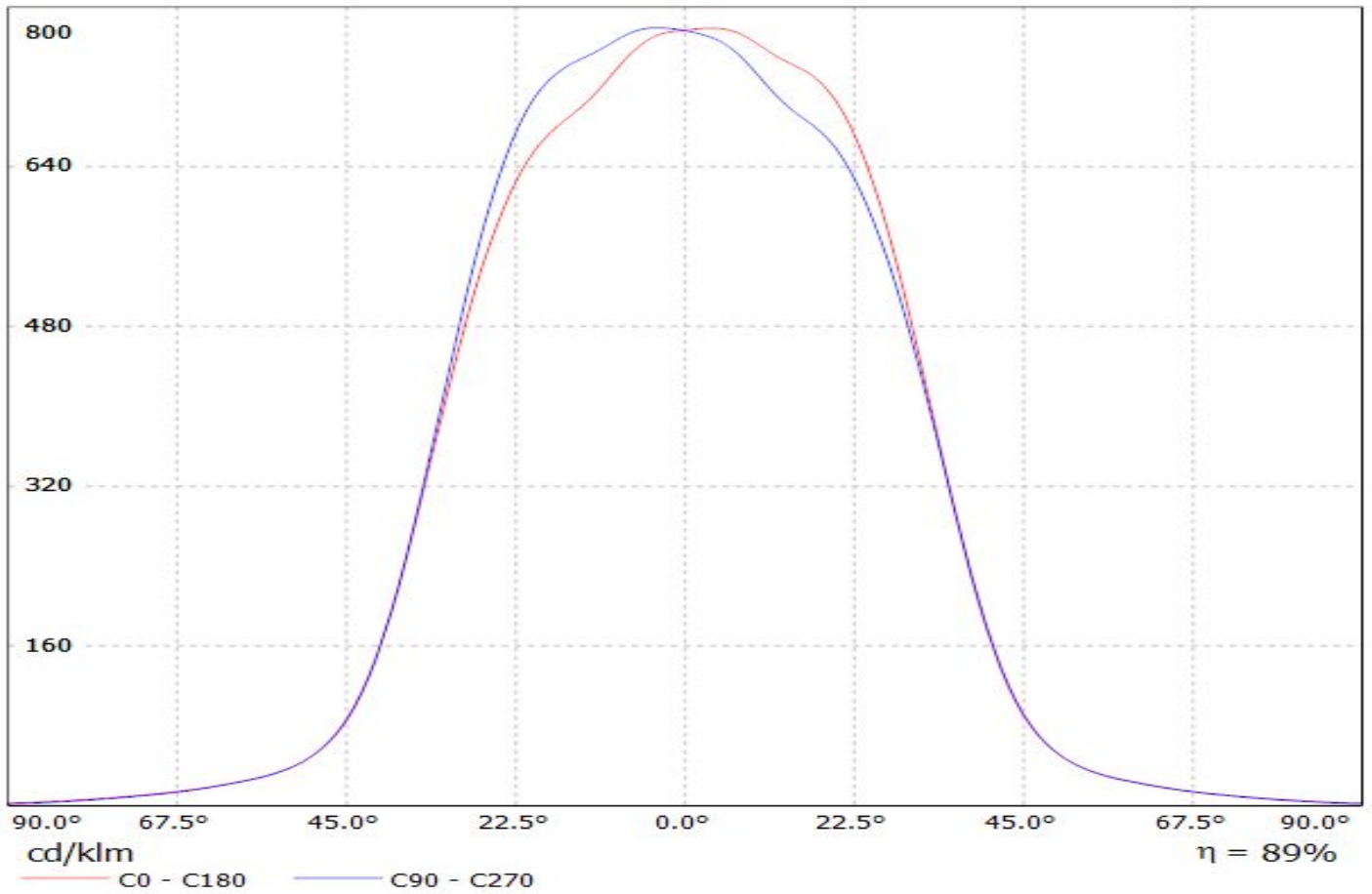

Luminaire: LEDiL Oy C13232_HB-2X2-WW_(WICOP2_Z8Y19)

Lamps: 1 x SEOUL_WICOP2_Z8Y19_450.124lm@250mA_P=2.8579W_I=0.250A

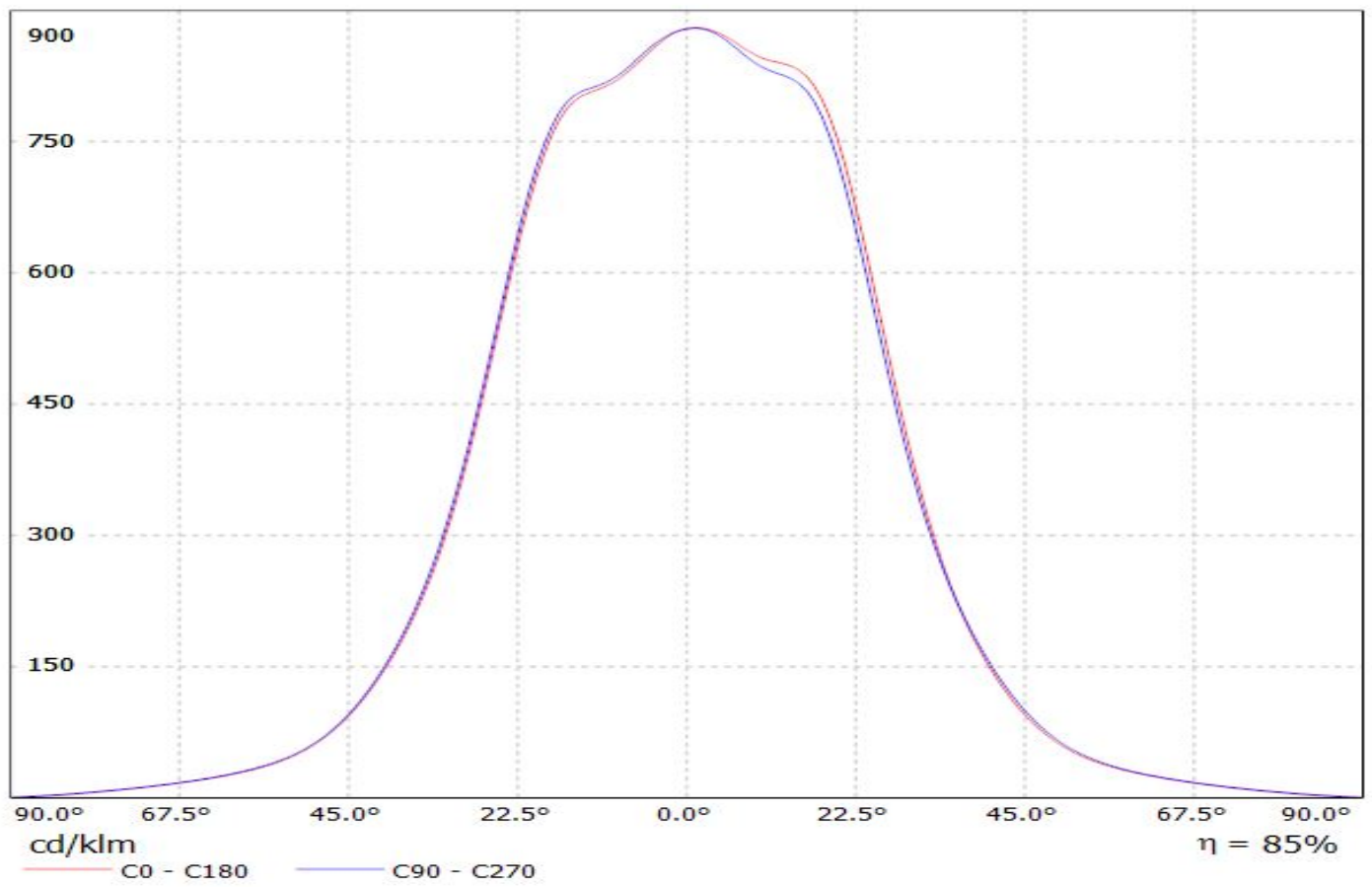

Luminaire: LEDiL Oy C13232_HB-2X2-WW_(WICOP2_Z8Y15)

Lamps: 1 x SEOUL_WICOP2_Z8Y15_336.842lm@250mA_P=2.9399W_I=0.250A

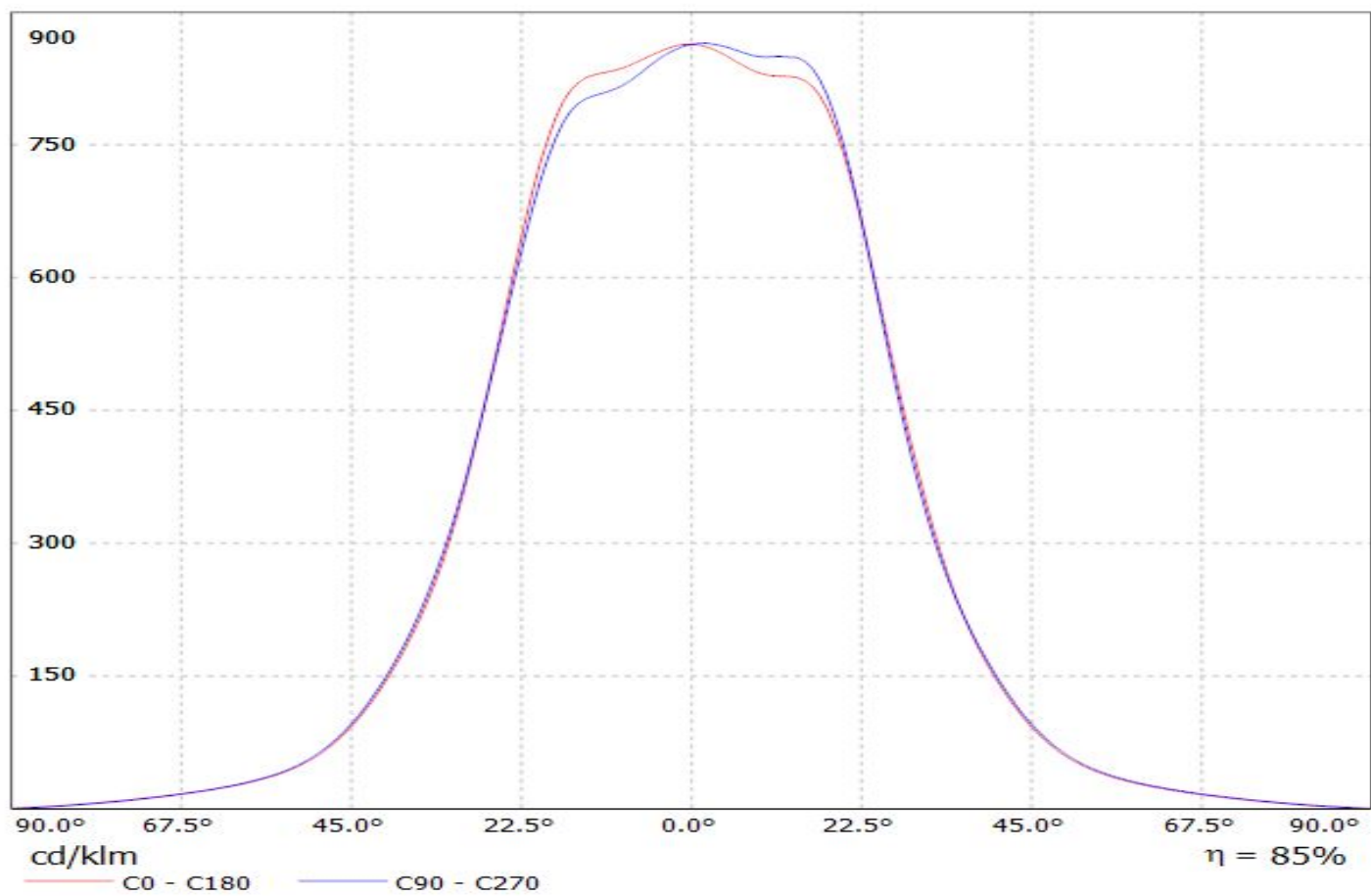

Ledil C13232_HB-2X2-WW_(TL1L4) / LDC (Linear)

Luminaire: Ledil C13232_HB-2X2-WW_(TL1L4)

Lamps: 1 x Toshiba_TL1L4_2x2_(TL1L4-DW0)_472.639lm@250mA_CCT=6500K_P=2.9W_I=0.25A

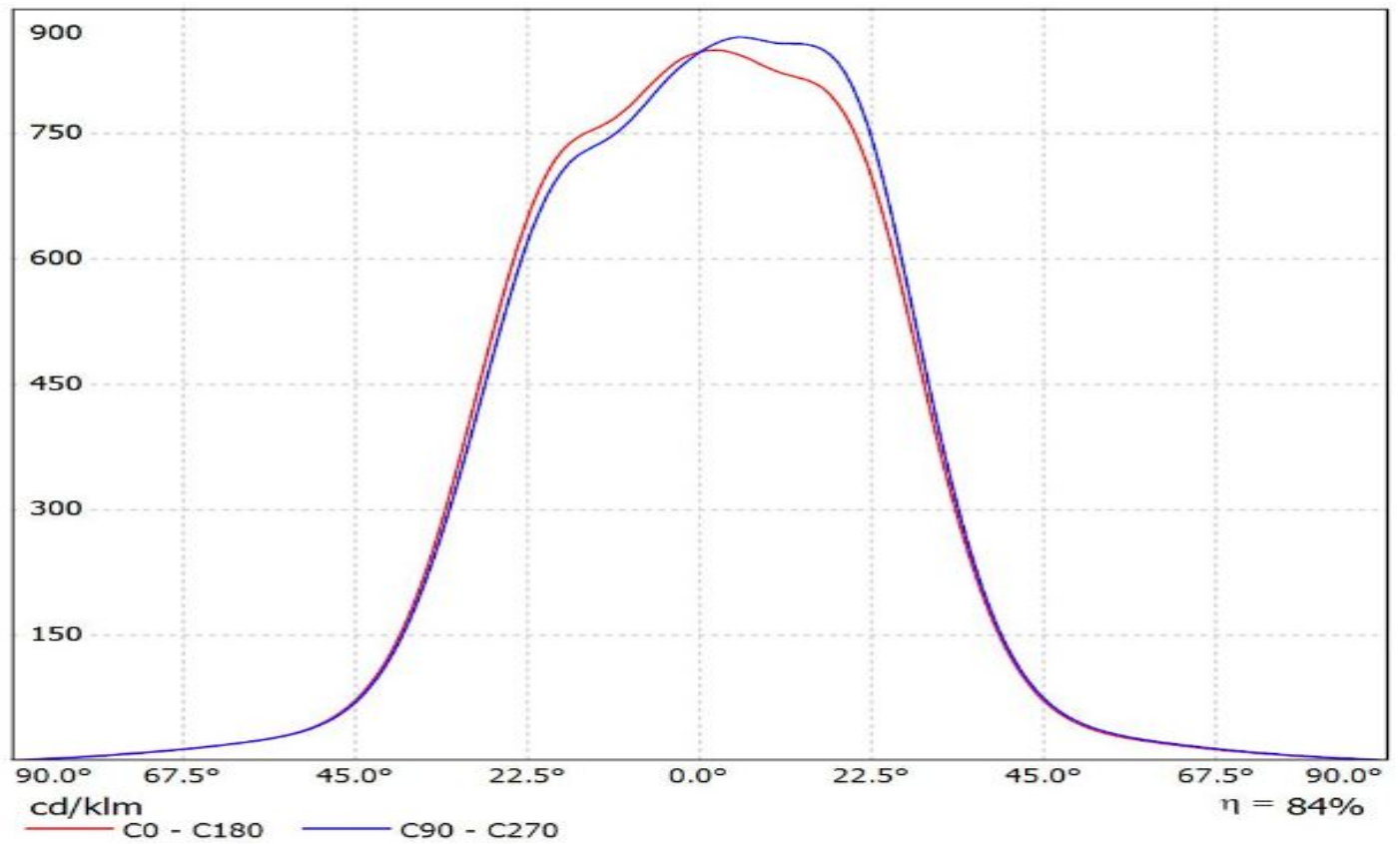

Luminaire: LEDiL Oy C13232_HB-2X2-WW_(Tridonic_Module_RLE_G1)
Lamps: 1 x Tridonic_Module_RLE_G1_4576.03lm@700mA_P=32.0681W_I=0.700A

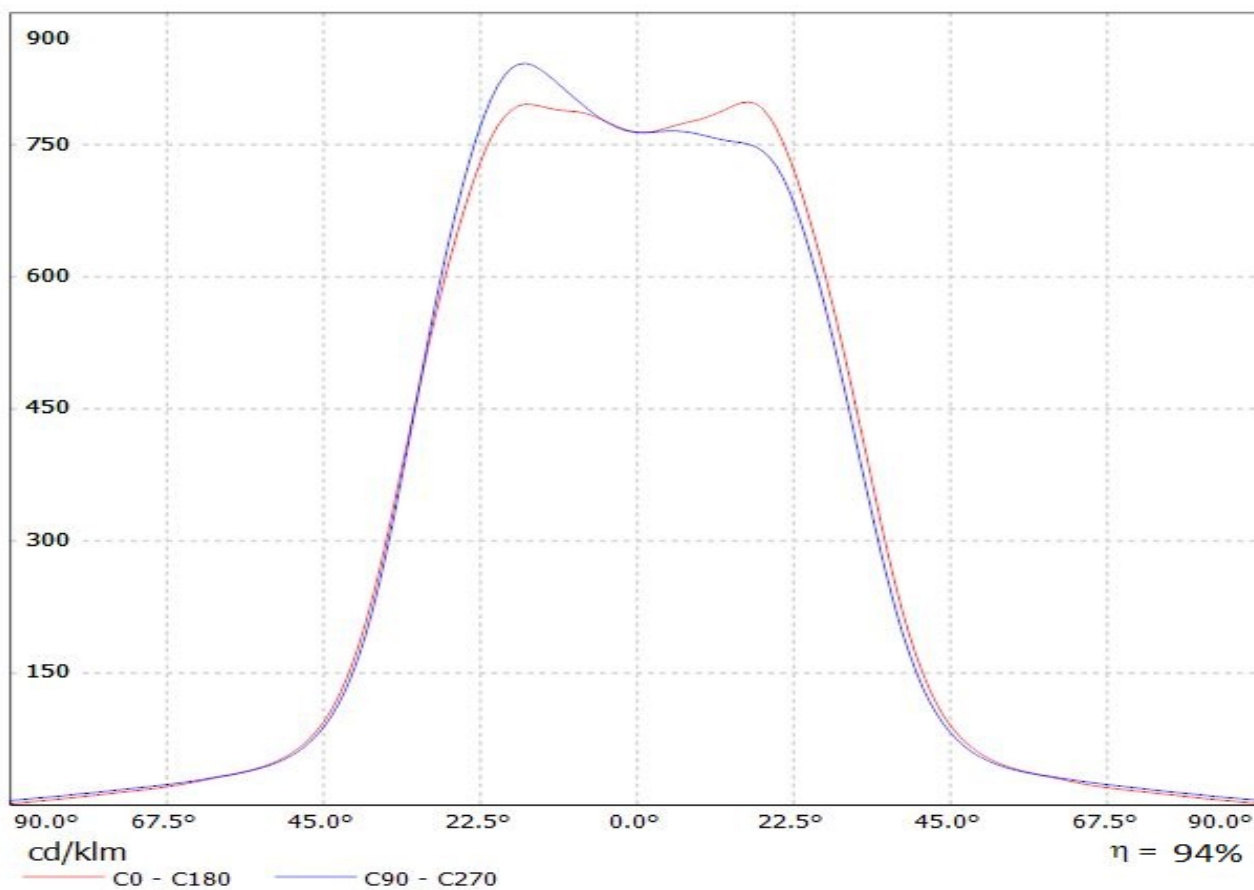

Luminaire: LEDiL Oy C13232_HB-2X2-WW_(Tridonic_Module_RLE_G1)
Lamps: 1 x Tridonic_Module_RLE_G1_4576.03lm@700mA_P=32.0681W_I=0.700A

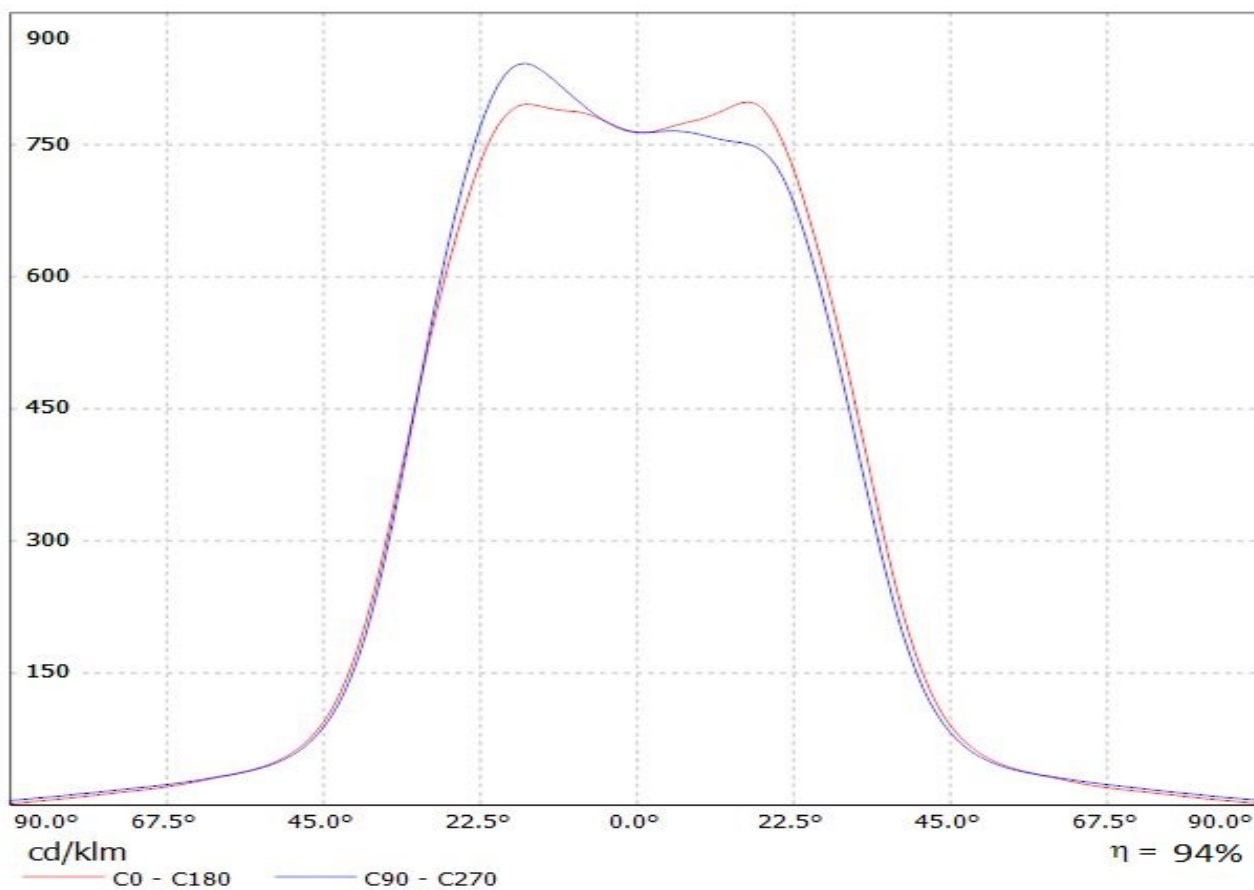

Luminaire: LEDiL Oy C13232_HB-2X2-WW_(Tridonic_Module_RLE_G1)
Lamps: 2 x Tridonic_Module_RLE_G1_2288lm@700mA_P=16W_I=0.700A

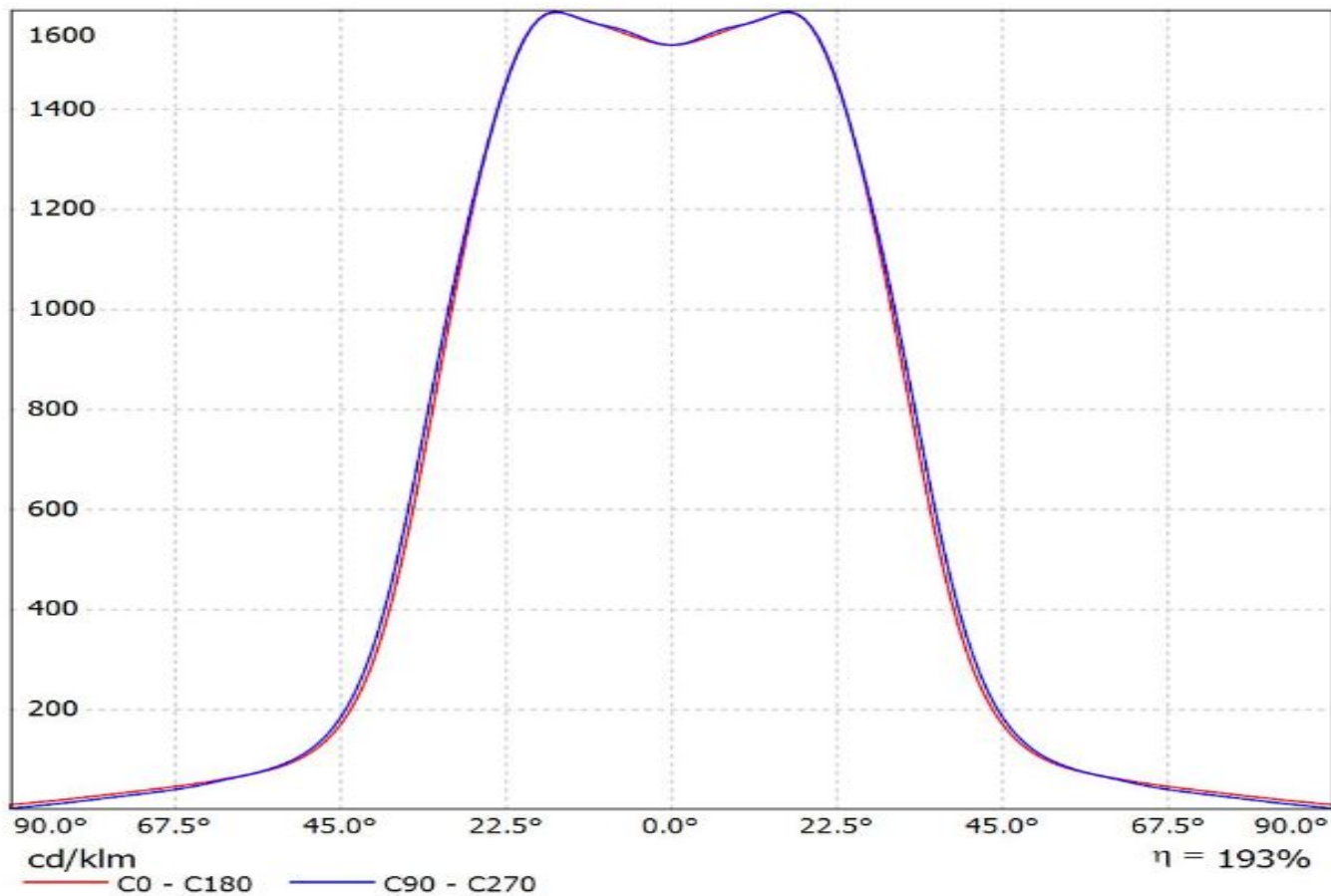

Luminaire: LEDiL Oy C13232_HB-2X2-WW_(Tridonic_Module_RLE_G1)
Lamps: 2 x Tridonic_Module_RLE_G1_2288lm@700mA_P=16W_I=0.700A

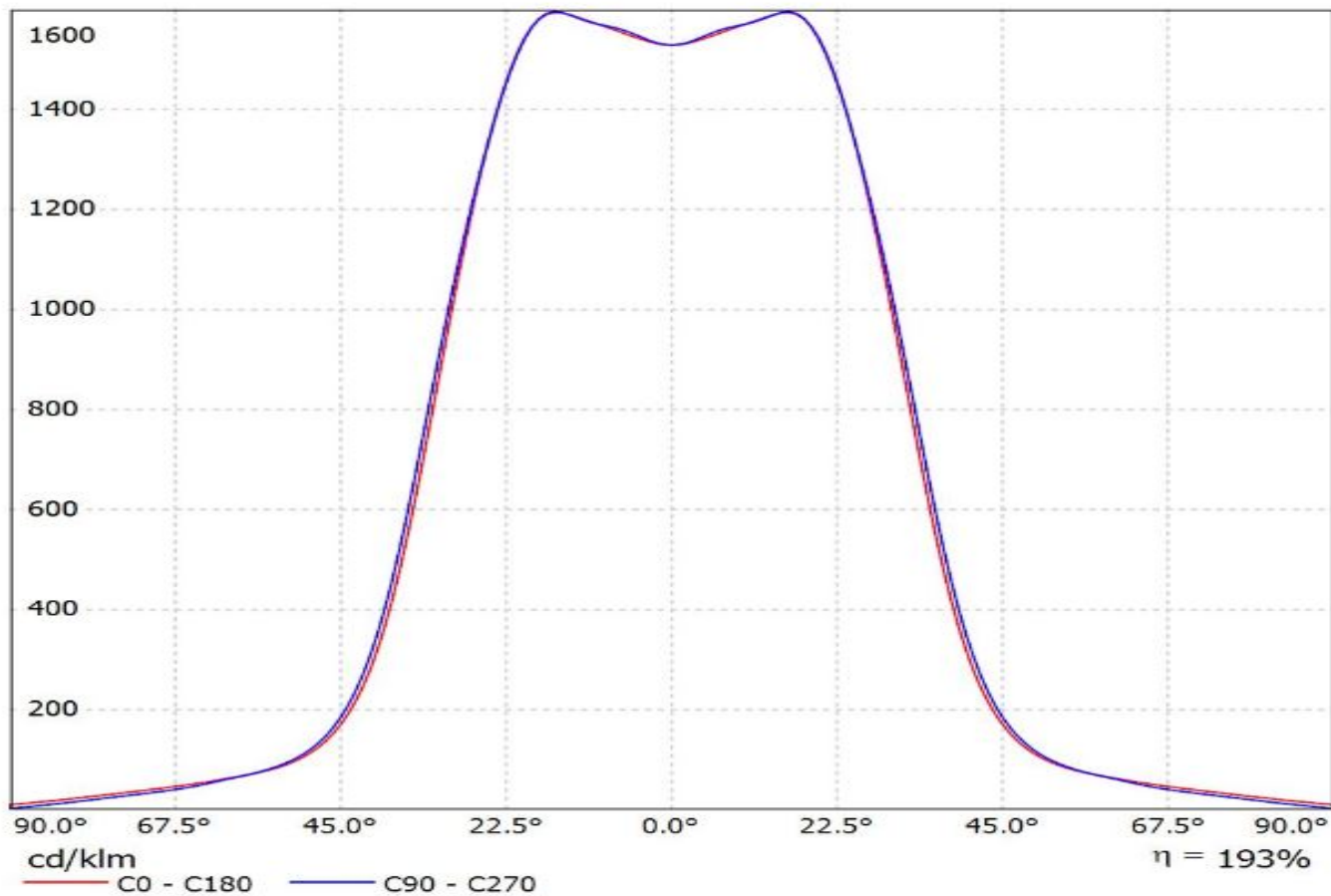

Luminaire: Ledil Oy C13237&C13232_HB-2X2-WW (Cree XT-E 390lm @ 250mA) Efficiency=91%
Lamps: 1 x Cree XT-E 390lm @ 250mA

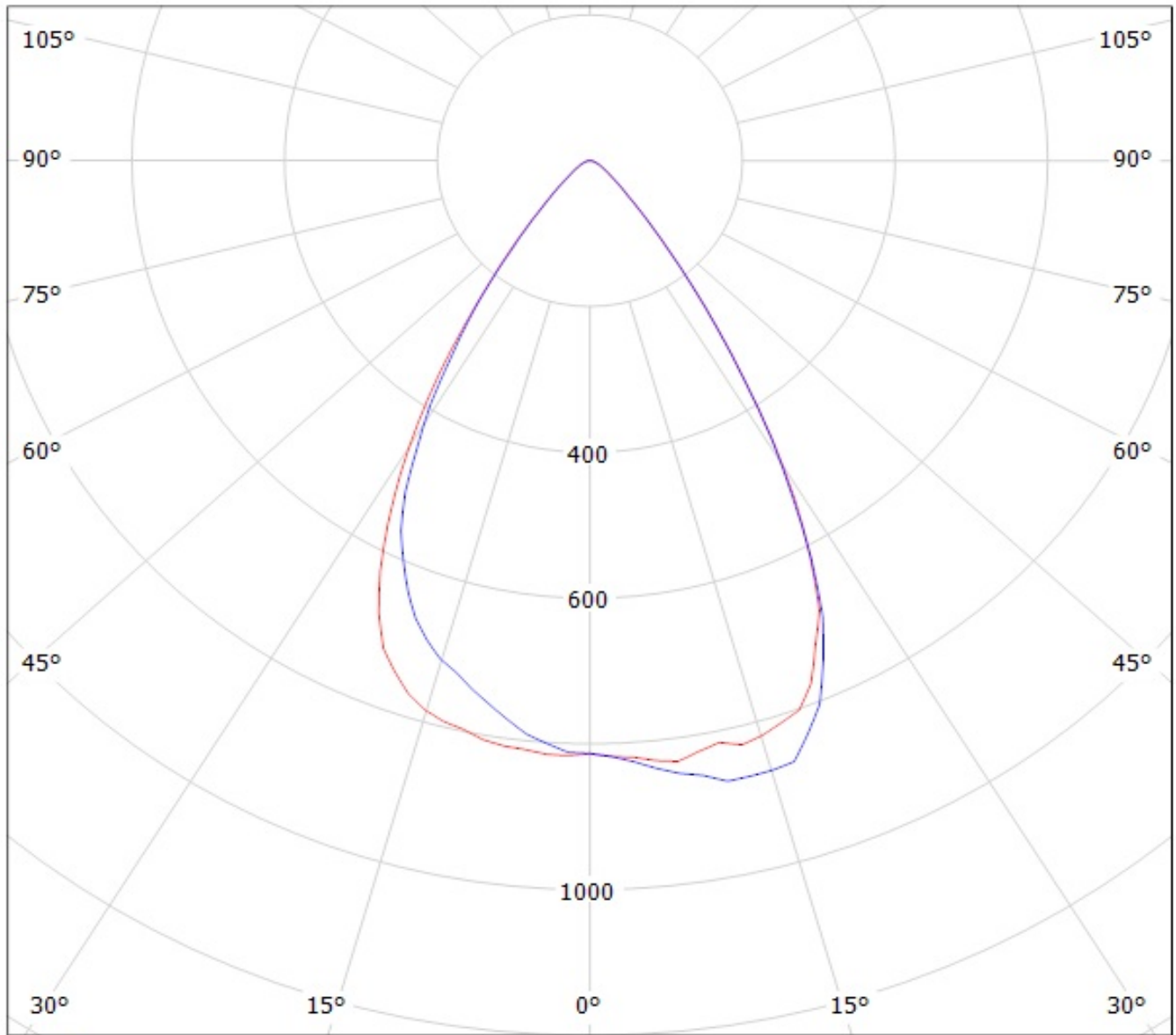

cd/klm

— C0 - C180

— C90 - C270

Luminaire: Ledil Oy C13237&C13232_HB-2X2-WW (Cree XP-G2 420lm @ 250mA) Efficiency=91%
Lamps: 1 x Cree XP-G2 420lm @ 250mA

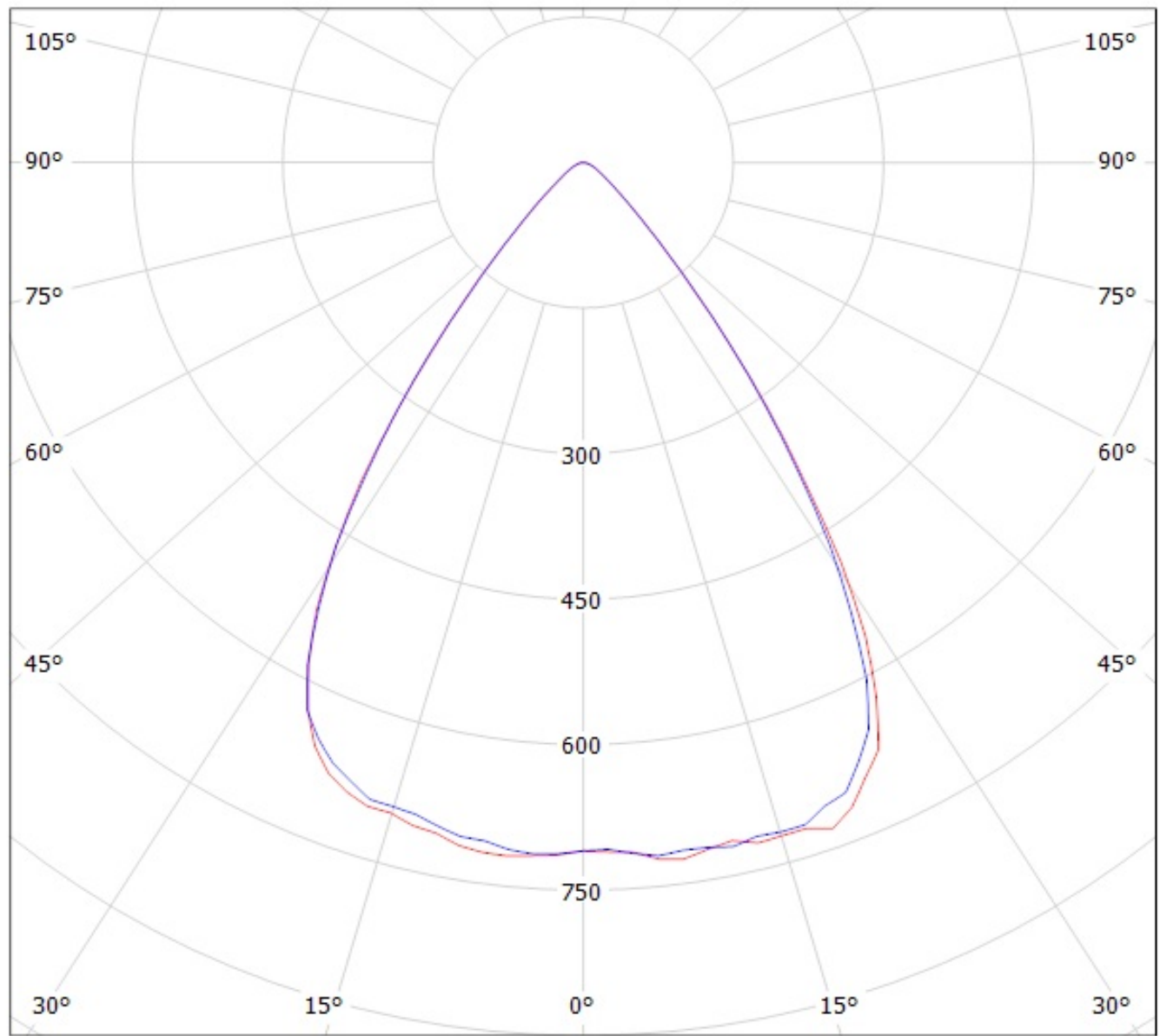

cd/klm
— C0 - C180 — C90 - C270

Luminaire: Ledil Oy C13237&C13232_HB-2X2-WW (Cree XP-G 257lm @ 250mA) Efficiency=91%
Lamps: 1 x Cree XP-G 257lm @ 250mA

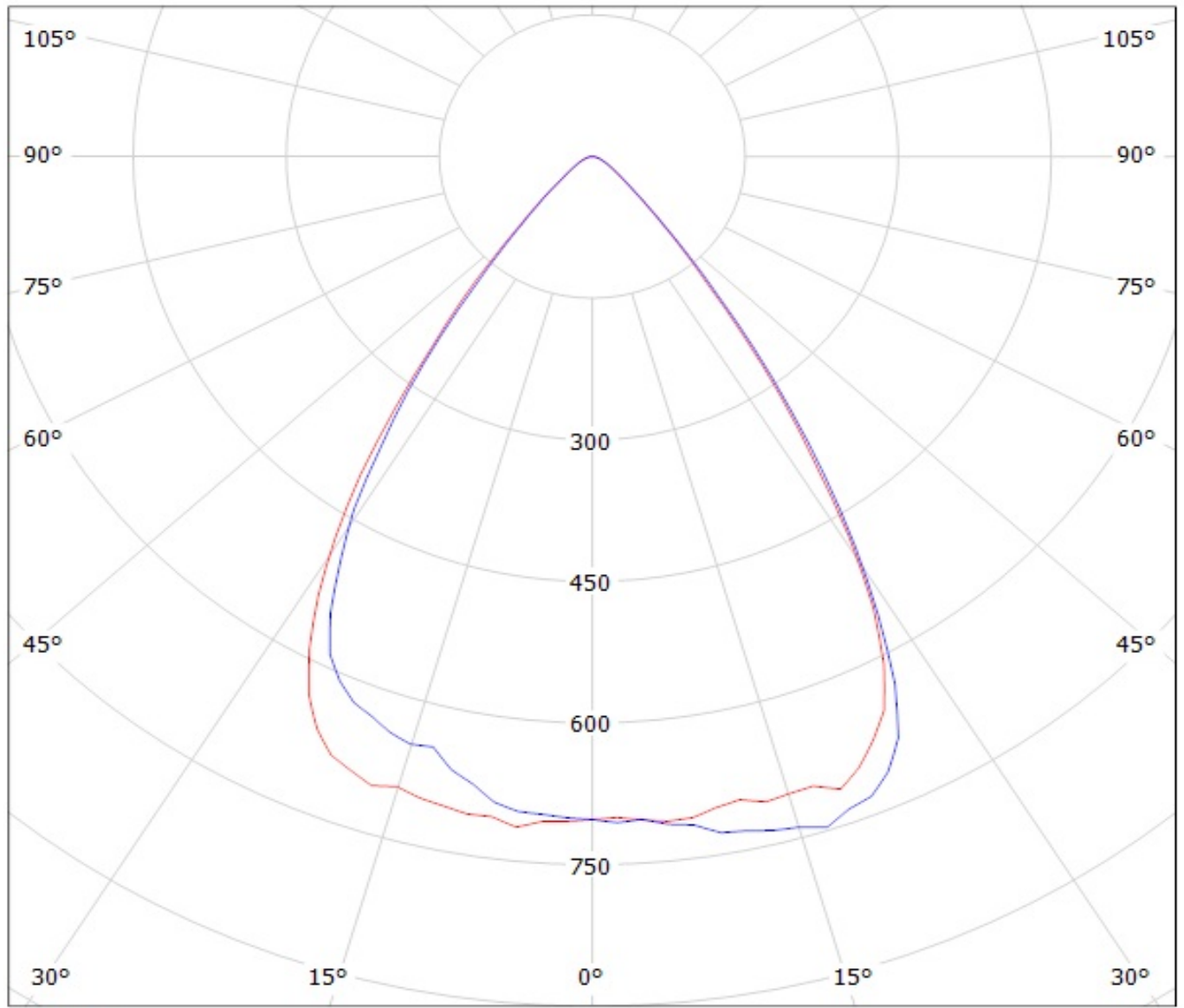

cd/klm

— C0 - C180

— C90 - C270

Luminaire: Ledil Oy C13232_HB-2x2-WW_(3535_Ceramic_gen2) Efficiency=89%
Lamps: 1 x LG 3535 Ceramic gen2 (PKG5700K) 461lm @ 250mA CCT=6600K P=2.9W I=250mA

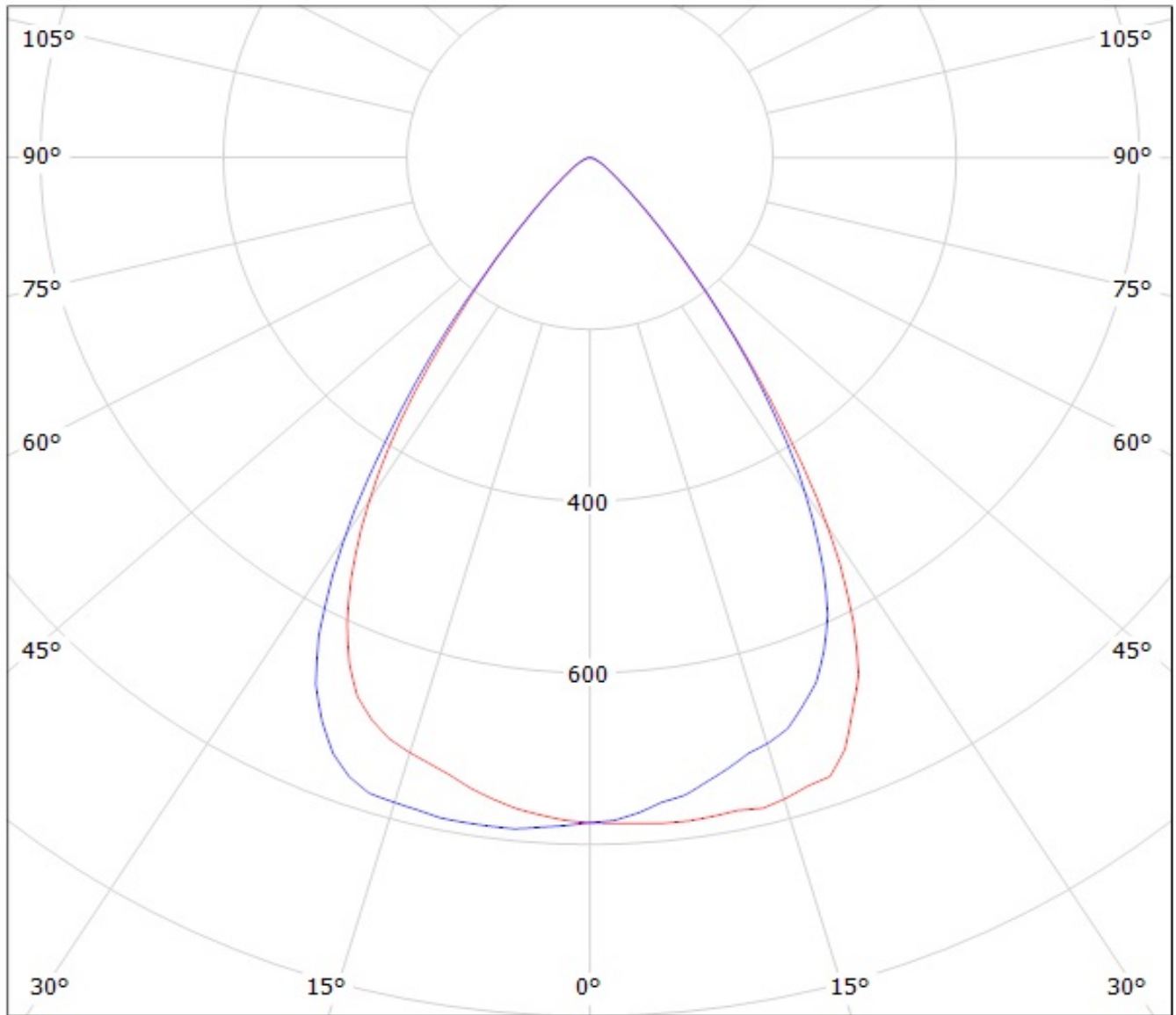

cd/klm

— C0 - C180 — C90 - C270

Luminaire: Ledil Oy C13232_HB-2X2-WW_(Luxeon_Z_ES) Efficiency=90%
Lamps: 1 x Luxeon Z ES (LXZ2-3090) 209lm @ 250mA CCT=3000k P=2.8W I=250mA

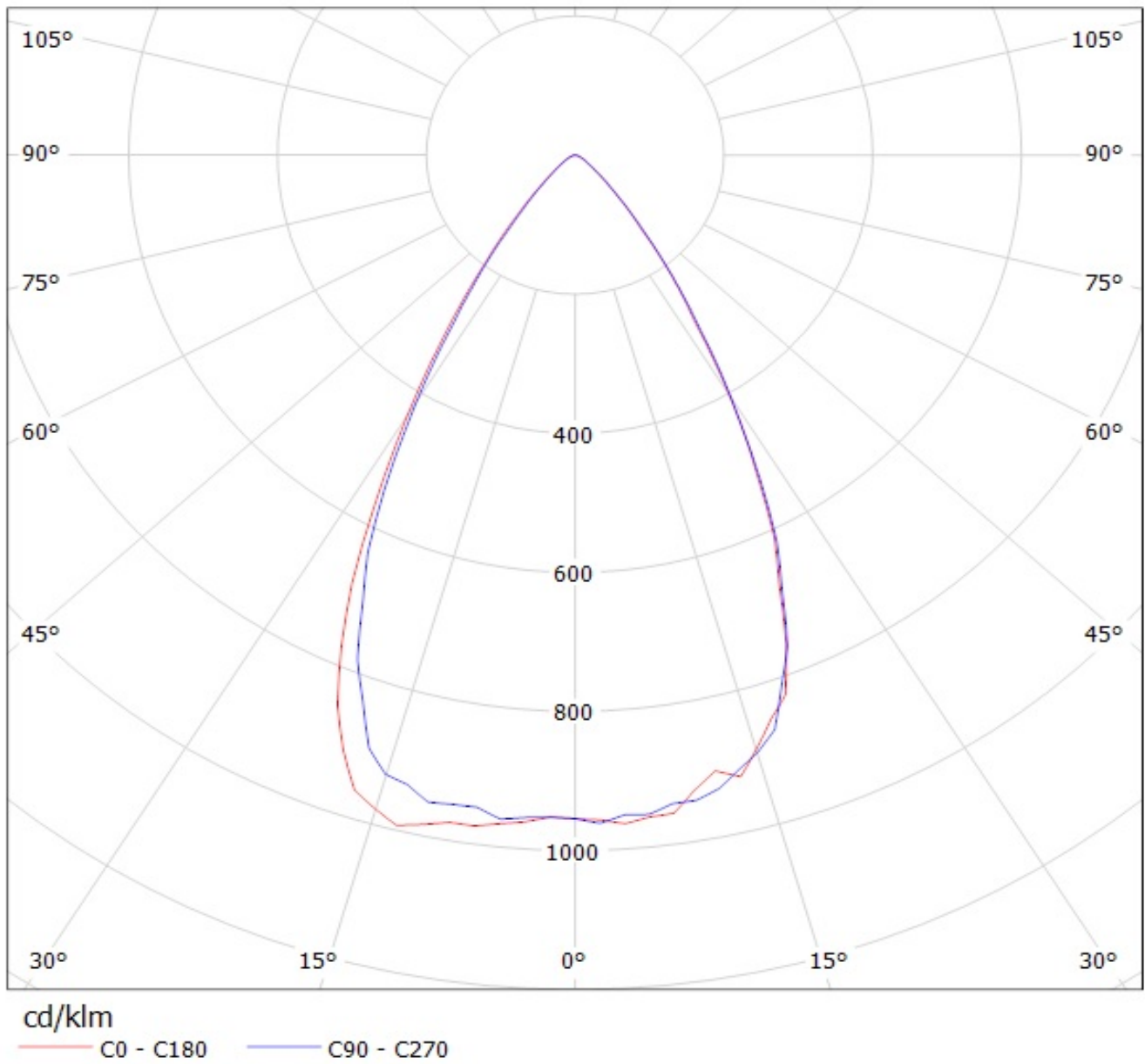

Luminaire: LEDiL Oy C13232_HB-2X2-WW_(LUXEON_Q) Eff.90.8%

Lamps: 1 x LUXEON_Q_2x2_(LHQ-3080)_298.363lm@250mA_P=2.87385W_I=249.9mA

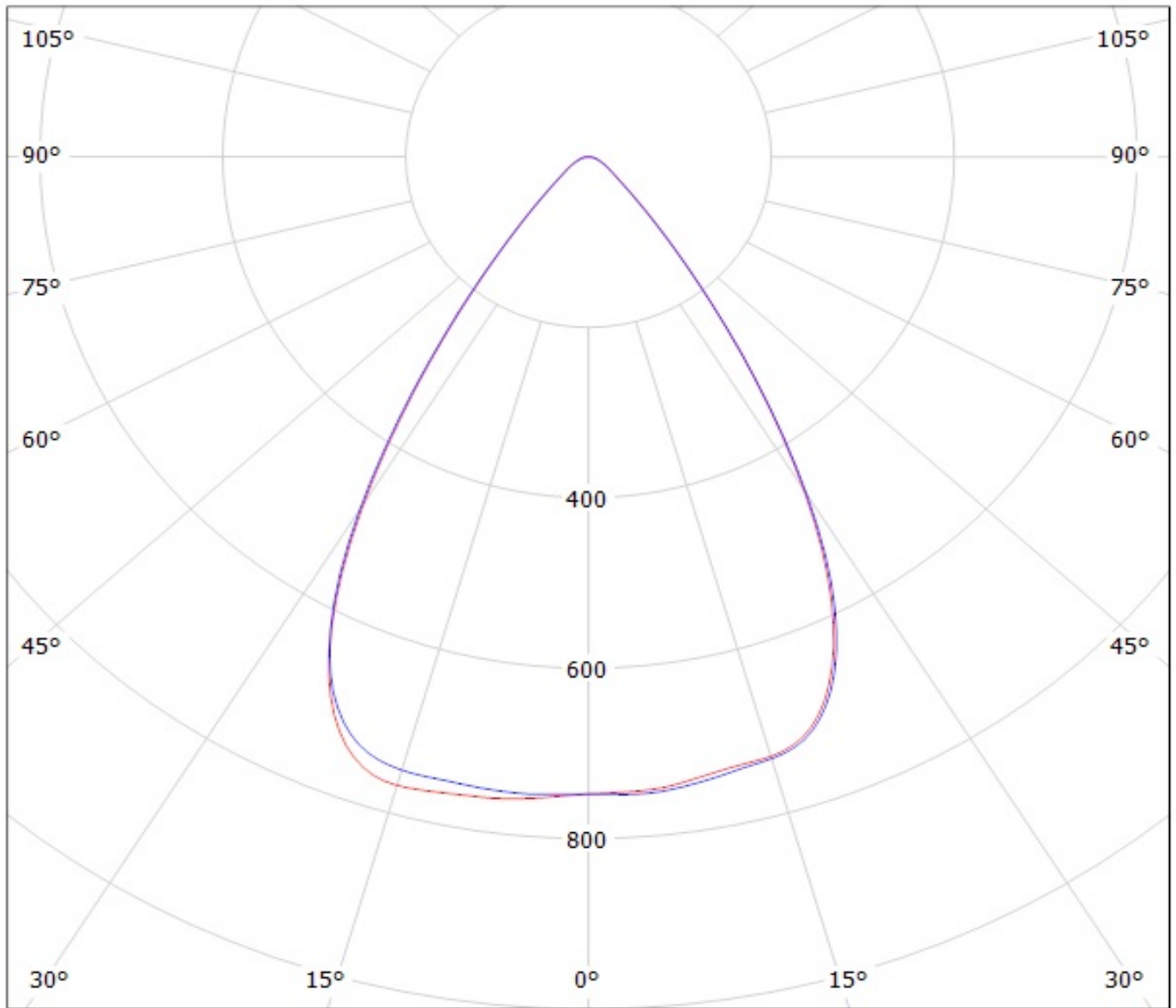

cd/klm

— C0 - C180

— C90 - C270

Luminaire: Ledil Oy C13237&C13232_HB-2X2-WW (Nichia NVS19B 306lm @ 250mA) Efficiency=91%
Lamps: 1 x Nichia NVS19B 306lm @ 250mA

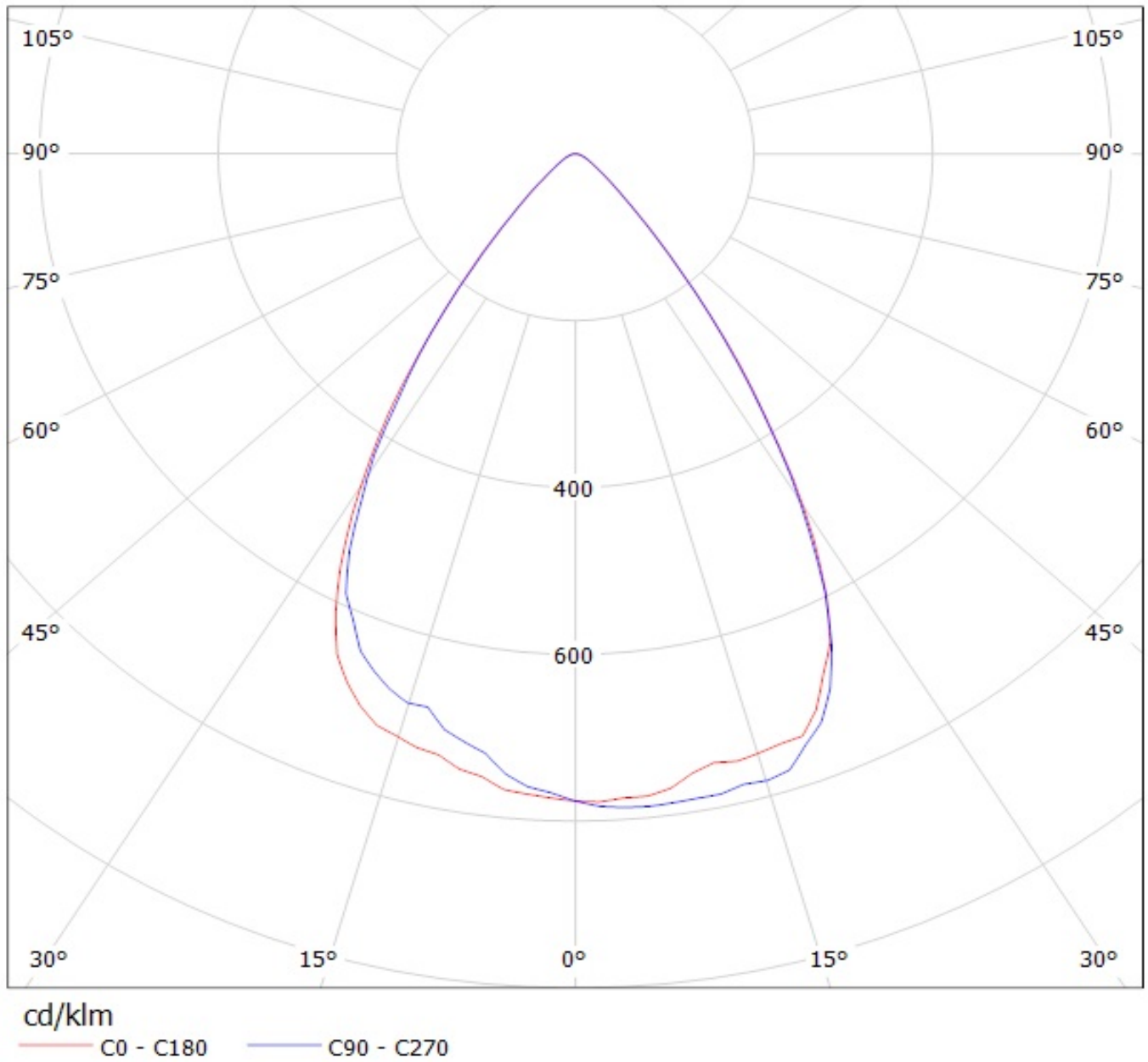

Luminaire: LEDiL Oy C13232_HB-2x2-WW_(Osram_Square_PC) Eff. 91,6%
Lamps: 1 x Osram Square PC (385lm@100mA)

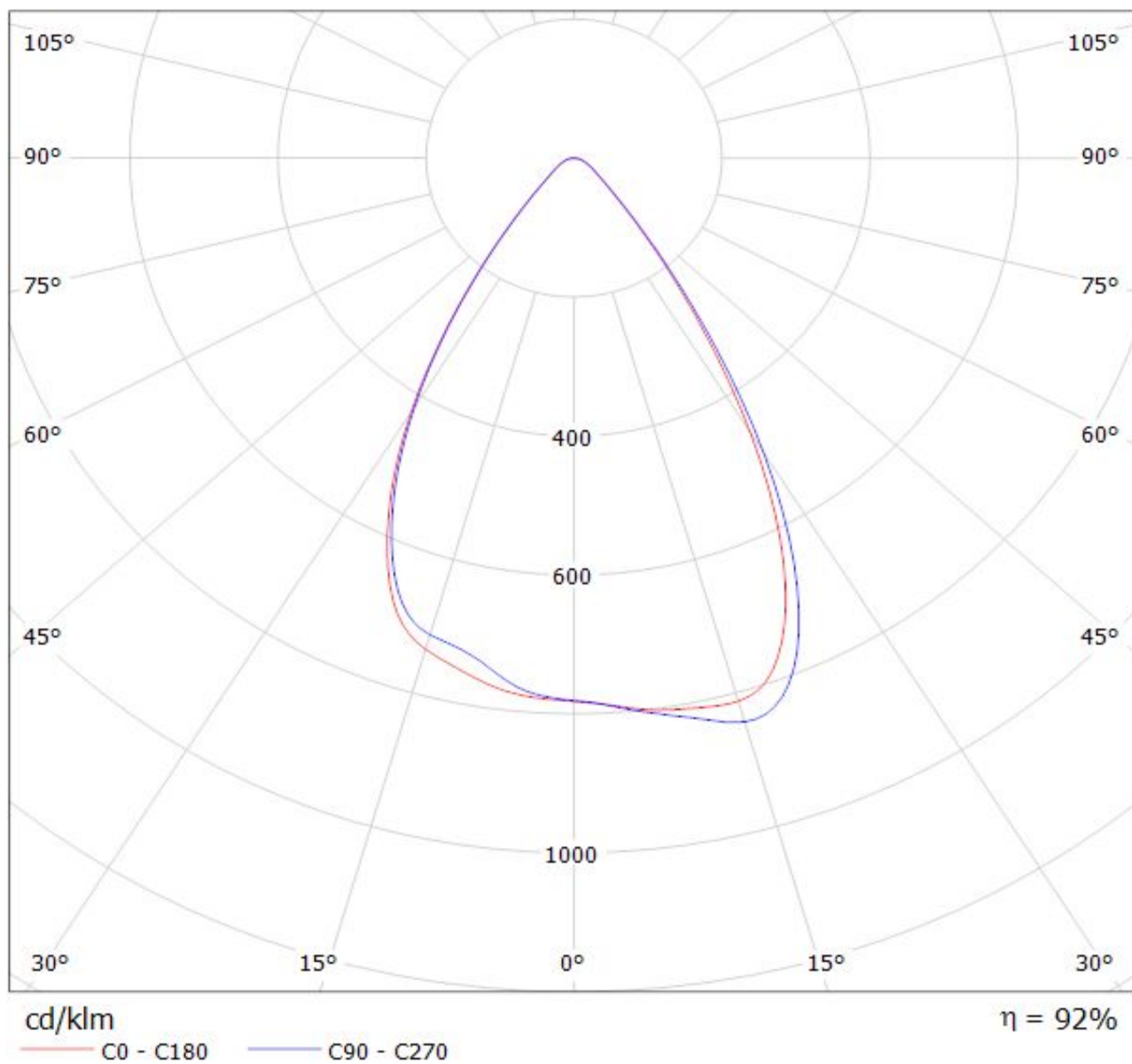

LEDiL Oy C13232_HB-2x2-WW_(SSL80) Eff.91.5% / LDC (Polar)

Luminaire: LEDiL Oy C13232_HB-2x2-WW_(SSL80) Eff.91.5%

Lamps: 1 x Osram Oslon SSL80 (308lm@250mA)

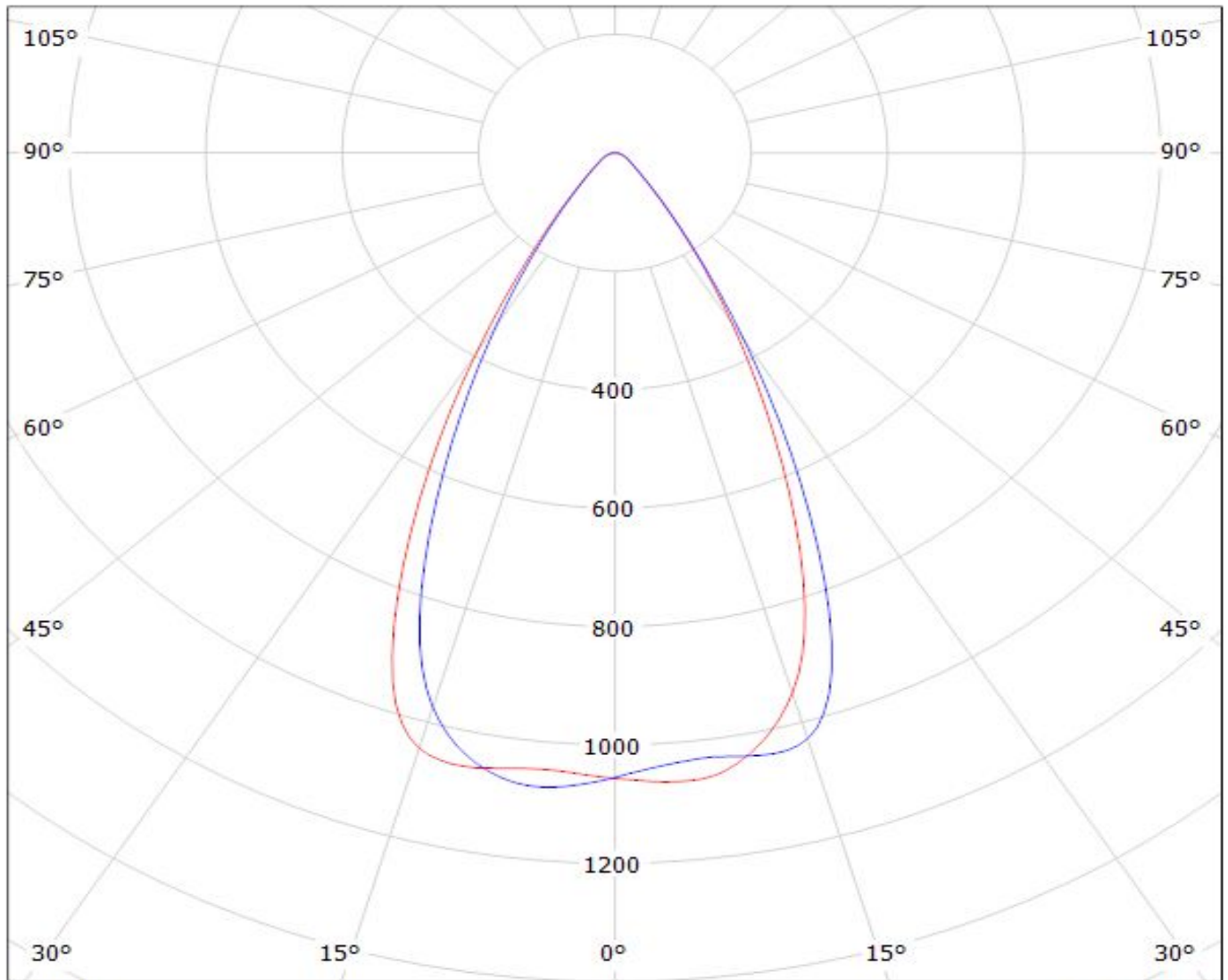

cd/klm

— C0 - C180

— C90 - C270

$\eta = 91\%$

LEDiL Oy C13232_HB-2x2-WW_(Samsung_3535) Eff.92.0% / LDC (Polar)

Luminaire: LEDiL Oy C13232_HB-2x2-WW_(Samsung_3535) Eff.92.0%
Lamps: 1 x Samsung_3535_(LH35A1) (333lm@250mA)

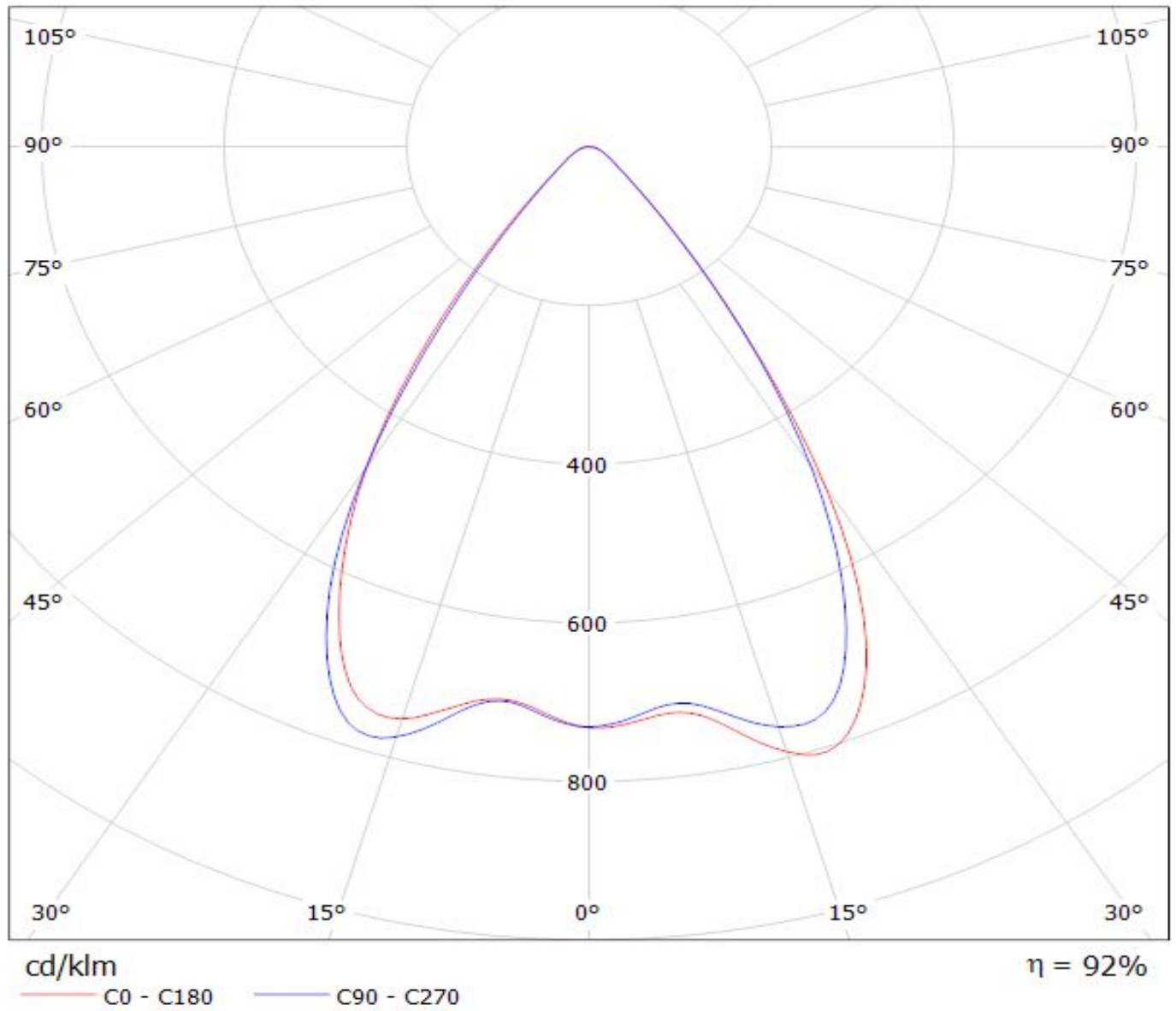

Luminaire: LEDiL Oy C13232_HB-2X2-WW_(LH351Z) Eff.89.0%
Lamps: 1 x SAMSUNG_LH351Z_2x2_359.49lm@250mA_P=2.86371W_I=249.8mA

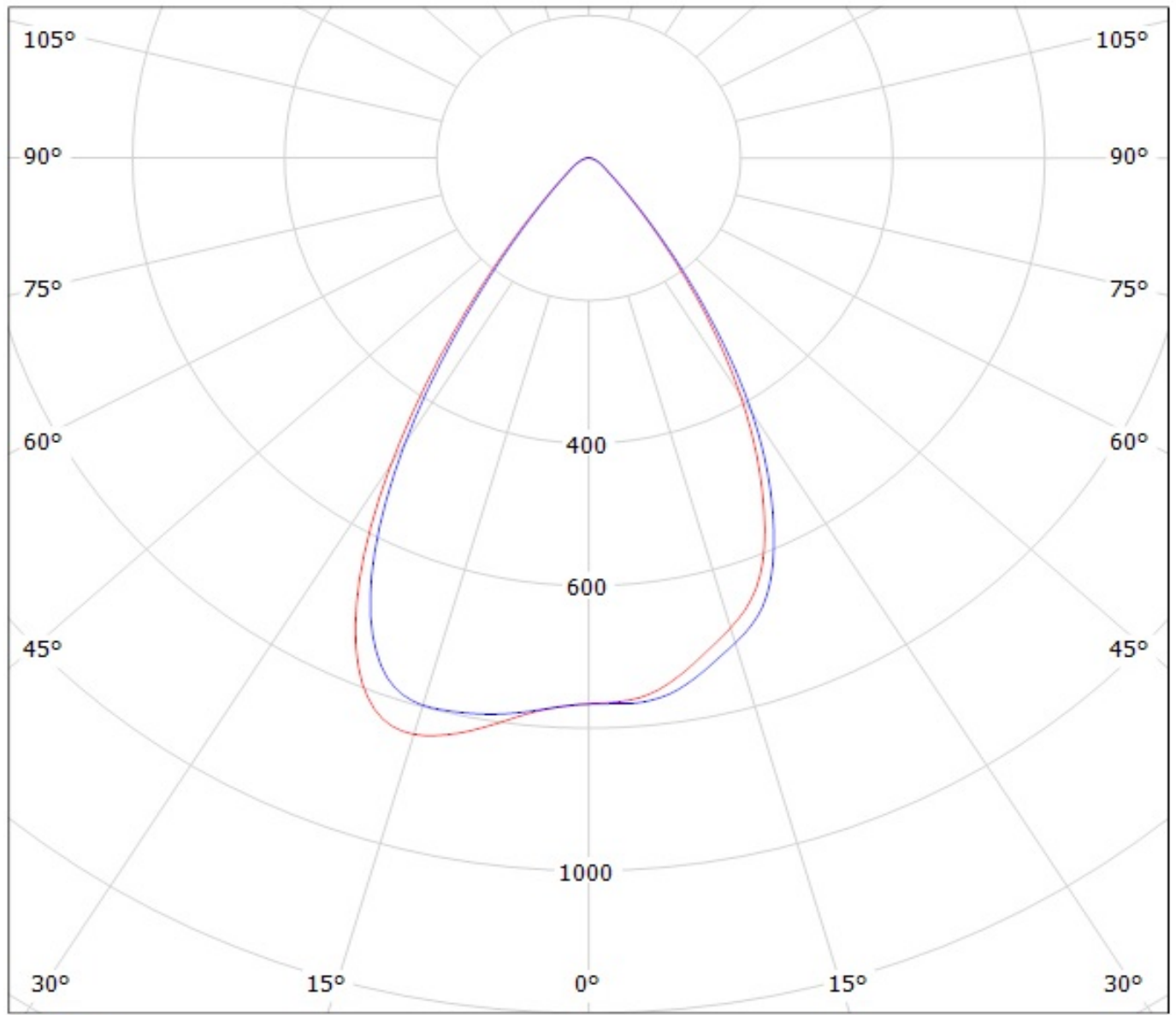

cd/klm

— C0 - C180 — C90 - C270

Luminaire: LEDiL Oy C13232_HB-2X2-WW_(LH351B) Eff.88.6%

Lamps: 1 x SAMSUNG_LH351B_2x2_430.715lm@250mA_P=2.84311W_I=249.9mA

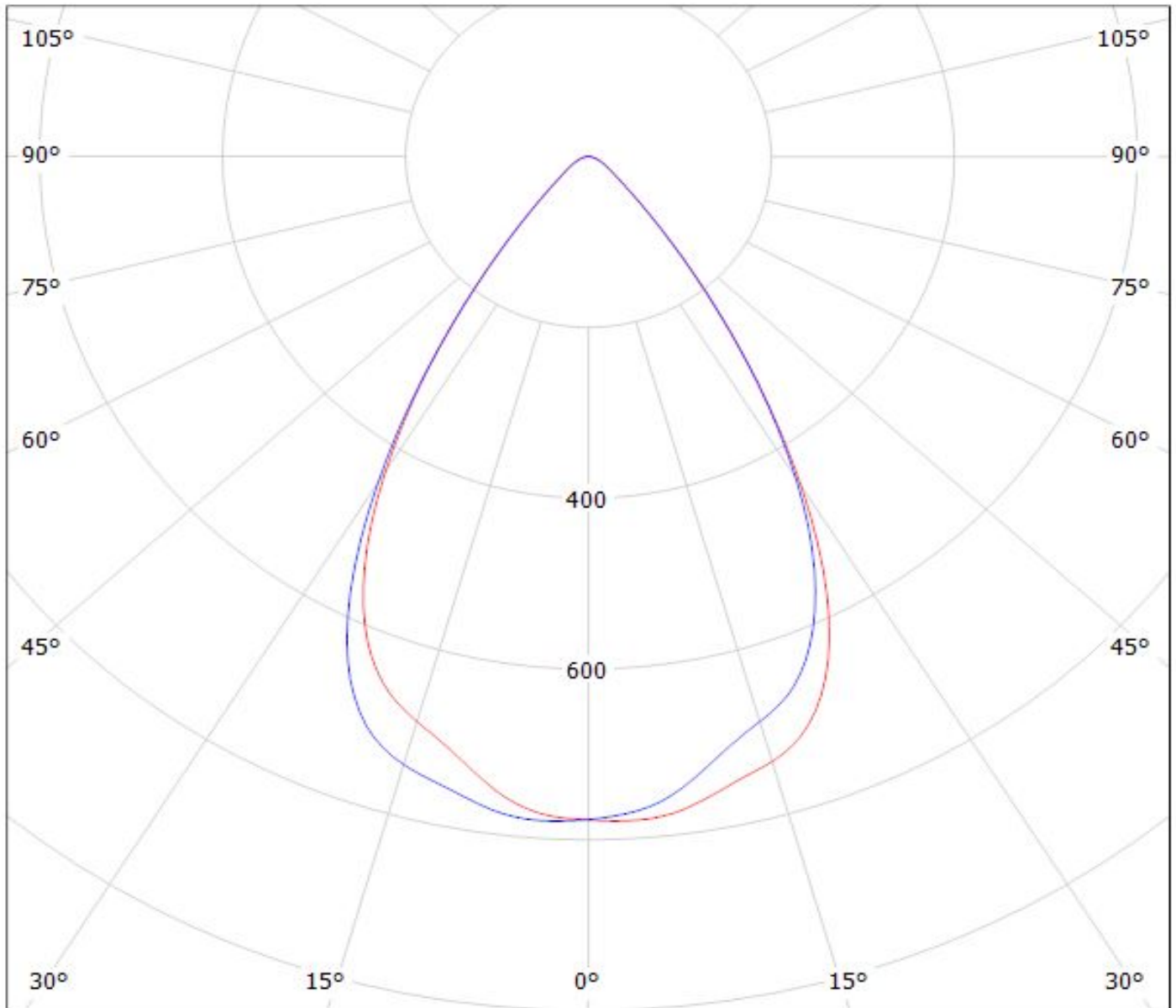

cd/klm

$\eta = 89\%$

— C0 - C180 — C90 - C270

Luminaire: LEDiL Oy C13232_HB-2X2-WW_(WICOP2_Z8Y19)

Lamps: 1 x SEOUL_WICOP2_Z8Y19_450.124lm@250mA_P=2.8579W_I=0.250A

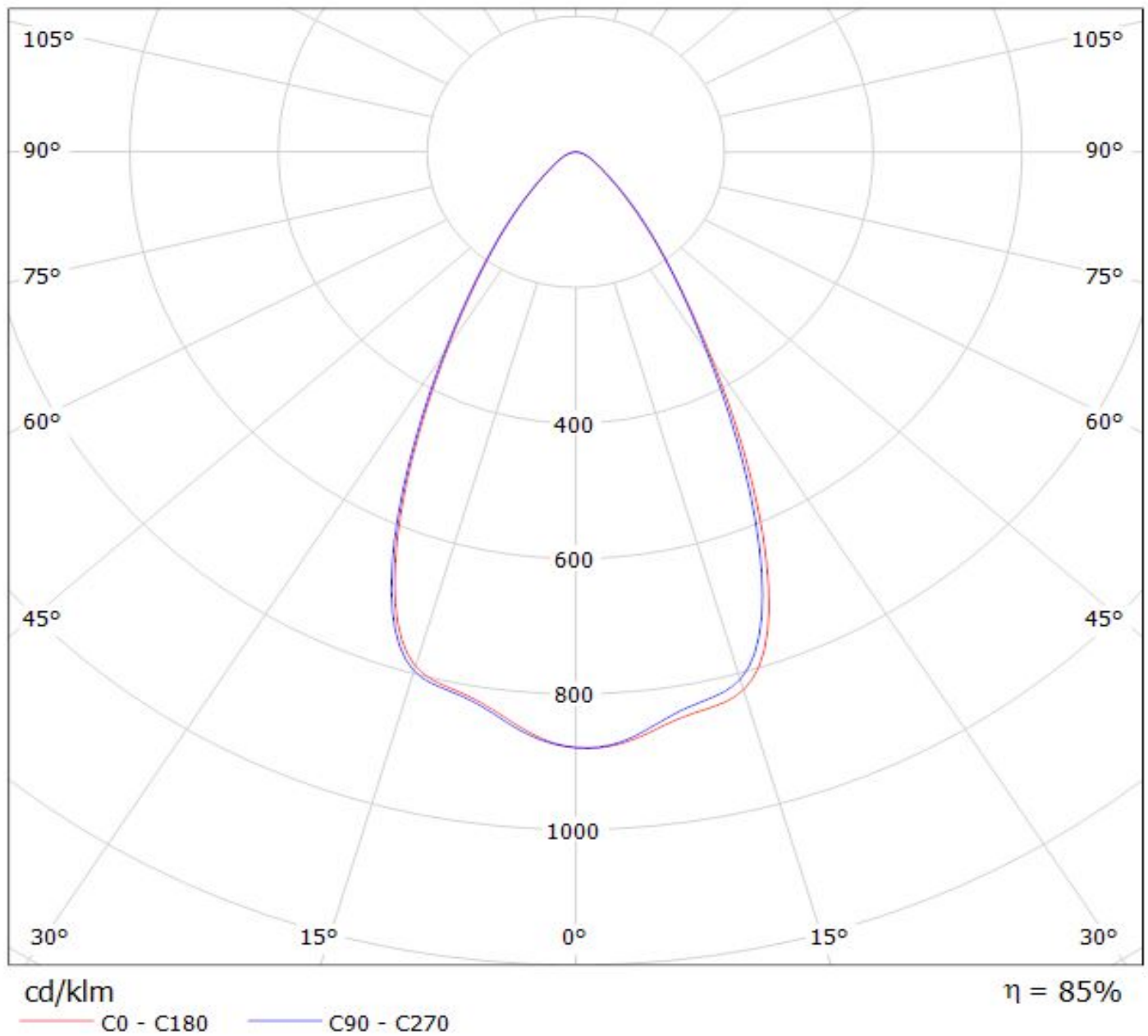

Luminaire: LEDiL Oy C13232_HB-2X2-WW_(WICOP2_Z8Y15)

Lamps: 1 x SEOUL_WICOP2_Z8Y15_336.842lm@250mA_P=2.9399W_I=0.250A

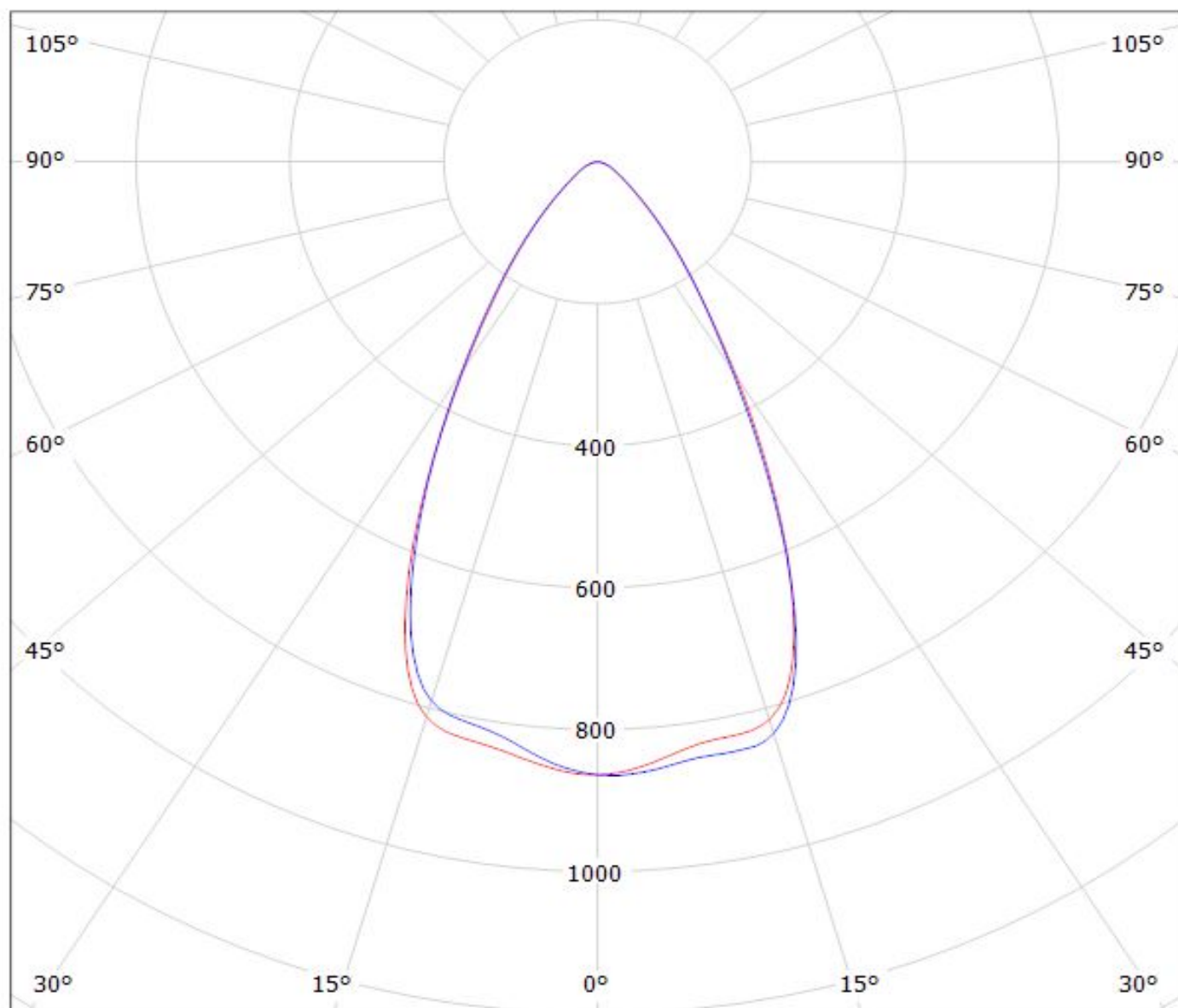

cd/klm

— C0 - C180

— C90 - C270

$\eta = 85\%$

Ledil C13232_HB-2X2-WW_(TL1L4) / LDC (Polar)

Luminaire: Ledil C13232_HB-2X2-WW_(TL1L4)

Lamps: 1 x Toshiba_TL1L4_2x2_(TL1L4-DW0)_472.639lm@250mA_CCT=6500K_P=2.9W_I=0.25A

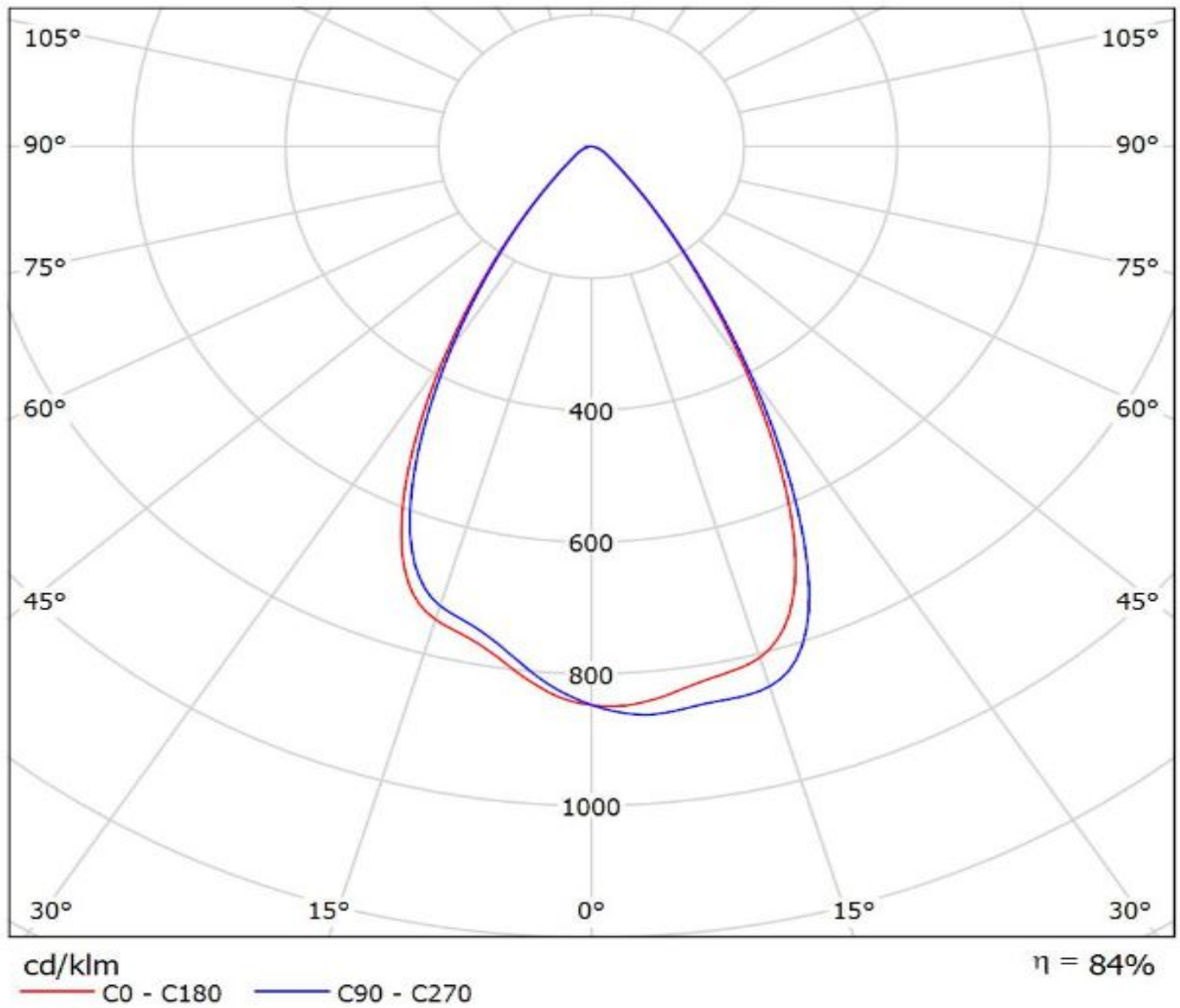

Luminaire: LEDiL Oy C13232_HB-2X2-WW_(Tridonic_Module_RLE_G1)
Lamps: 1 x Tridonic_Module_RLE_G1_4576.03lm@700mA_P=32.0681W_I=0.700A

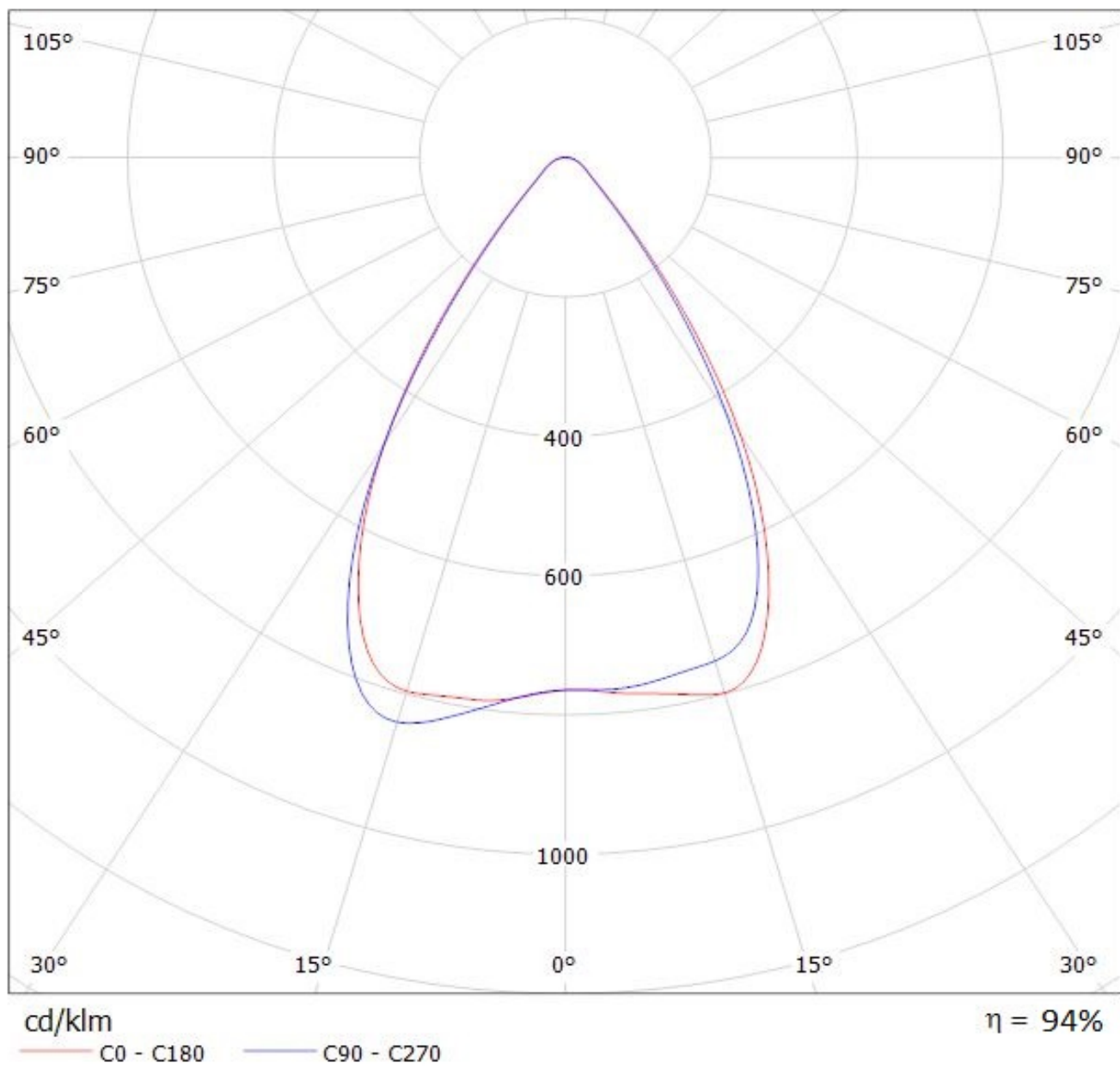

Luminaire: LEDiL Oy C13232_HB-2X2-WW_(Tridonic_Module_RLE_G1)
Lamps: 1 x Tridonic_Module_RLE_G1_4576.03lm@700mA_P=32.0681W_I=0.700A

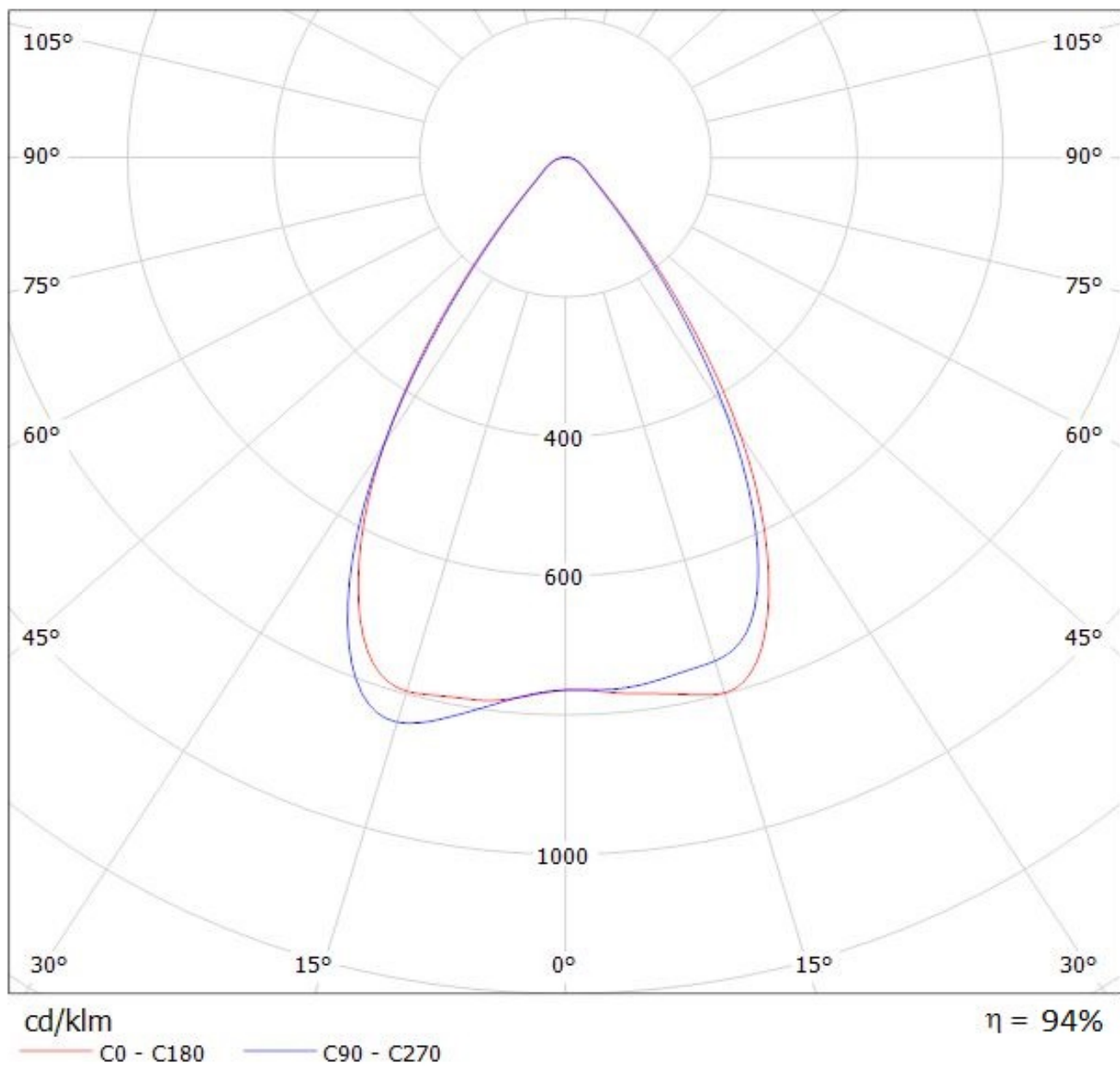

Luminaire: LEDiL Oy C13232_HB-2X2-WW_(Tridonic_Module_RLE_G1)
Lamps: 2 x Tridonic_Module_RLE_G1_2288lm@700mA_P=16W_I=0.700A

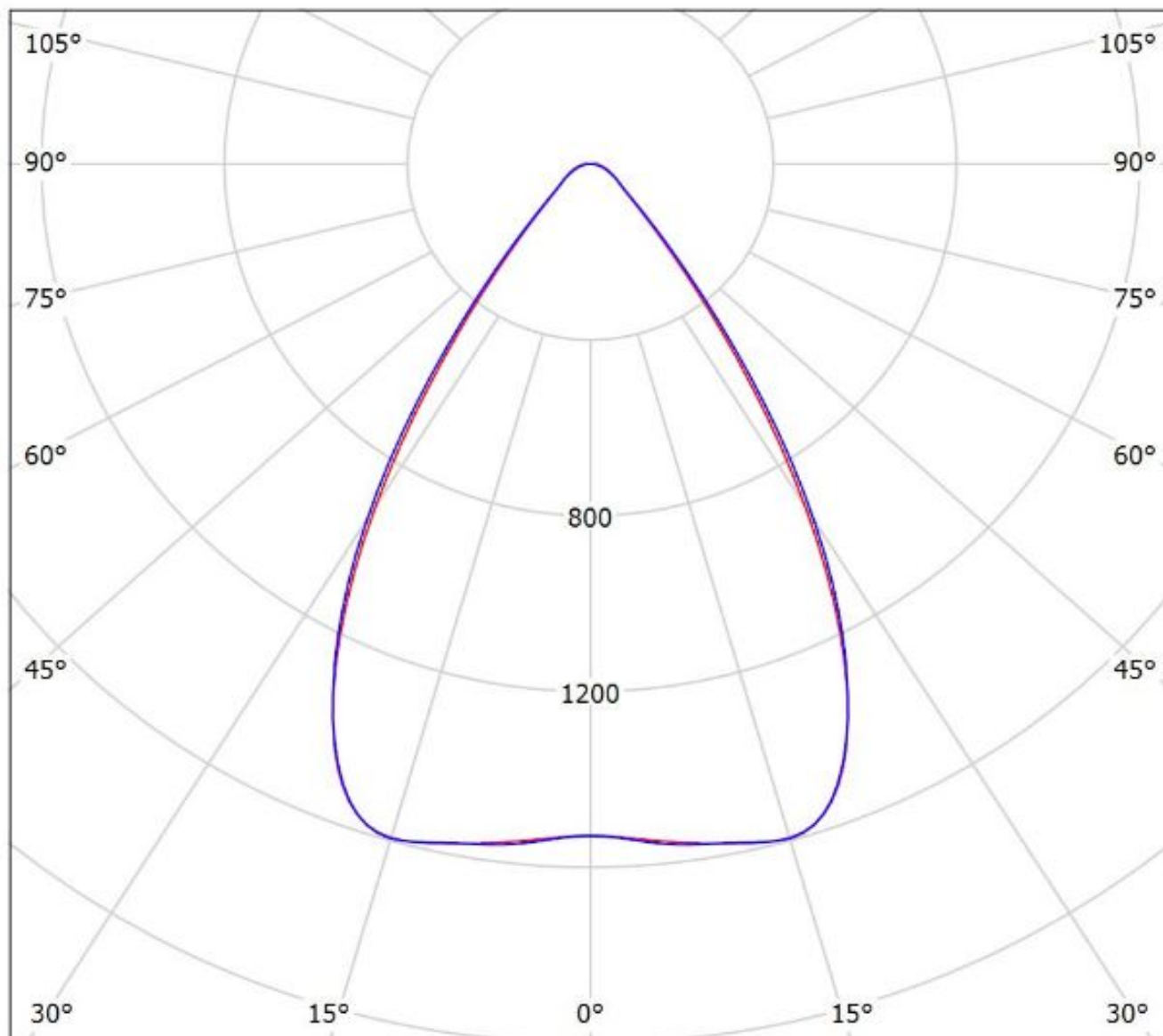

cd/klm
— C0 - C180 — C90 - C270

$\eta = 193\%$

Luminaire: LEDiL Oy C13232_HB-2X2-WW_(Tridonic_Module_RLE_G1)
Lamps: 2 x Tridonic_Module_RLE_G1_2288lm@700mA_P=16W_I=0.700A

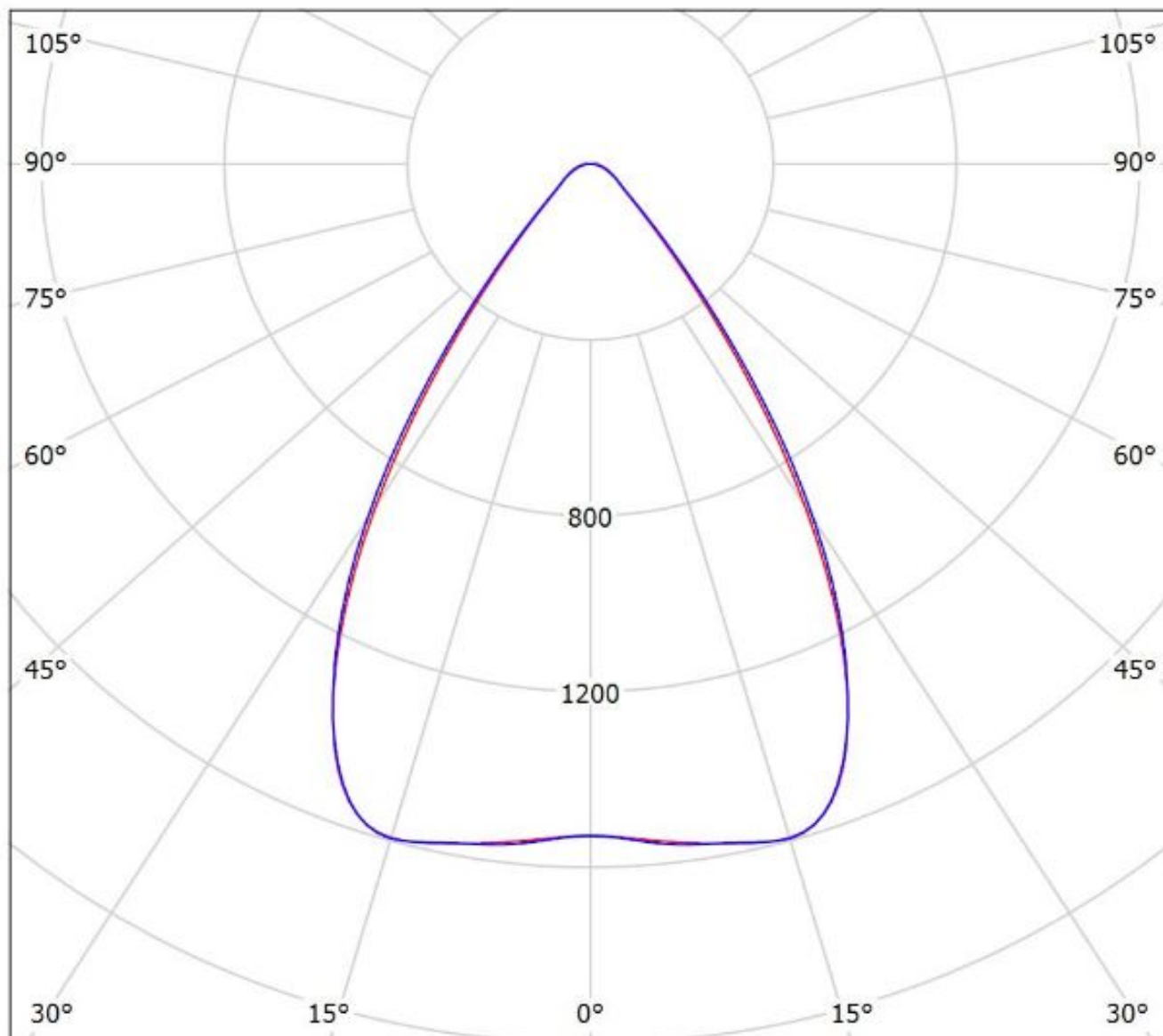

cd/klm
— C0 - C180 — C90 - C270

$\eta = 193\%$

NOTE: The typical divergence will be changed by different color, chip size and chip position tolerance. The typical total divergence is the full angle measured where the luminous intensity is half of the peak value.