

DETAILS

Product Number	C13300_STRADA-2X2-T2
Family	Strada-Module
Type	Lens array
Color	clear
Diameter	50 + 50 mm
Height	7,7 mm
Style	square
Optic Material	PMMA
Holder Material	
Fastening	screw, pin, glue
Status	ready
ROHS Compliant	Yes
Date Updated	6/10/2015



OPTICAL PROPERTIES

LED	Viewing Angle	Light Beam	Efficiency	cd/lm	Connector
XT-E	Asymmetric deg	Asymmetric	93 %	sim: 0.000	-
XP-G	Asymmetric deg	Asymmetric	94 %	1.100	-
LUXEON R	Asymmetric deg	Asymmetric	94 %	1.000	-
LUXEON Rebel ES	Asymmetric deg	Asymmetric	94 %	1.100	-
Oslon Square PC	Asymmetric deg	Asymmetric	94 %	1.000	-
XM-L	Asymmetric deg	Asymmetric	95 %	0.800	-
XB-D	Asymmetric deg	Asymmetric	94 %	1.100	-
XP-G2	Asymmetric deg	Asymmetric	91 %	1.000	-
Z5P	Asymmetric deg	Asymmetric	-	sim: 0.000	-
NVSxx19A	Asymmetric deg	Asymmetric	-	sim: 0.000	-
NCSxx19A	Asymmetric deg	Asymmetric	-	sim: 0.000	-
XM-L2	Asymmetric deg	Asymmetric	94 %	0.700	-
LUXEON T	Asymmetric deg	Asymmetric	94 %	1.100	-
H35C0 (LEMWA33)	Asymmetric deg	Asymmetric	94 %	1.000	-
NS9x383	Asymmetric deg	Asymmetric	95 %	0.800	-
Acrich MJT 4040	Asymmetric deg	Asymmetric	94 %	1.000	-
H35C1 (LEMWA33)	Asymmetric deg	Asymmetric	94 %	1.000	-
LUXEON Z ES	Asymmetric deg	Asymmetric	94 %	1.500	-
LUXEON H50-2	sim: Asymmetric	Asymmetric	-	sim: 0.000	-
LUXEON Q	asymmetric deg	Asymmetric	94 %	1.100	-
Z5M1/Z5M2	asymmetric deg	Asymmetric	94 %	1.100	-
XB-H	sim: Asymmetric	Asymmetric	sim: 91 %	sim: 0.000	-
XP-L	asymmetric deg	Asymmetric	94 %	0.830	-
LUXEON MZ	asymmetric deg	Asymmetric	94 %	1.000	-
LUXEON TX	asymmetric deg	Asymmetric	94 %	1.000	-

D C B A

4

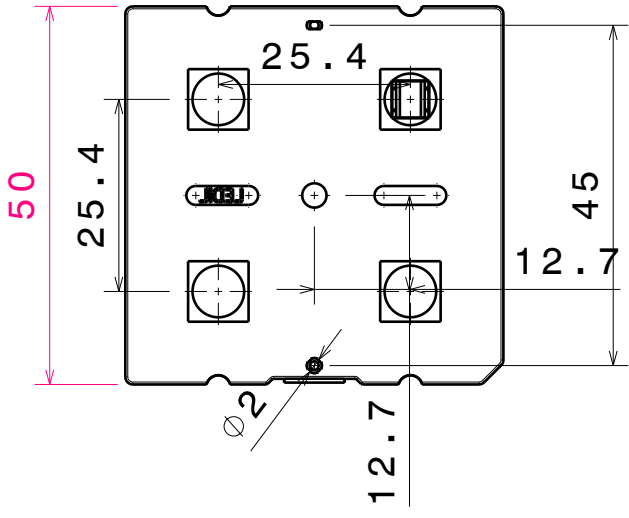

Bottom view

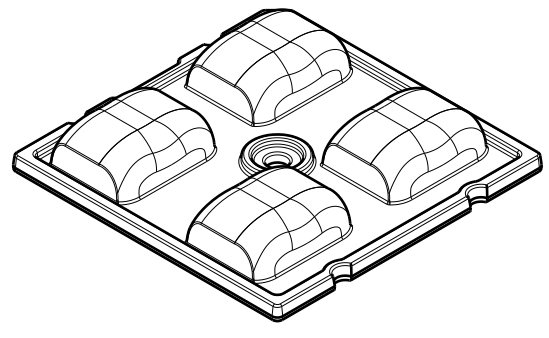

Isometric view

3

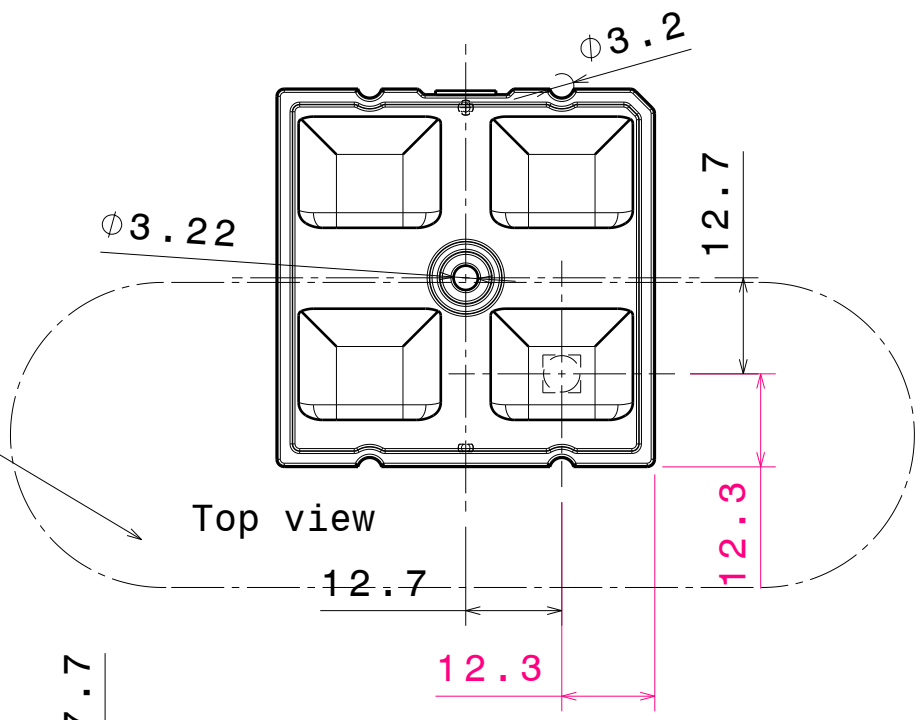

Top view

Beam Direction

2

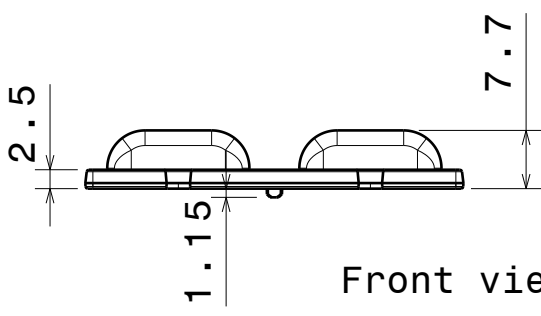

Front view

1

INDEX	PART NO	DESCRIPTION	MATERIAL	COLOUR
1	C13300	STRADA-2X2-T2	PMMA	

Tolerances if not otherwise shown
According to DIN ISO 2768-1
Linear measures:
Up to 30mm class M, otherwise class C.
According to DIN ISO 2768-2
Form and position: class L

LEDiL LediL Oy
Salorankatu 10
FIN 24240 SALO
Finland

THIRD ANGLE PROJECTION:

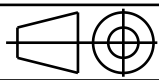

DRAWING TITLE
STRADA-2X2-T2

This drawing is the property of LEDiL Oy. It may not be reproduced, copied or communicated without a written agreement with LEDiL Oy."

SIZE
A4

C13300

SCALE 1:1 WEIGHT SHEET 1/1

D A

LEDiL Oy C13300_STRADA-2X2-T2_(XP-G) Eff.97.9% / LDC (Linear)

Luminaire: LEDiL Oy C13300_STRADA-2X2-T2_(XP-G) Eff.97.9%
Lamps: 1 x XP-G (249lm@250mA)

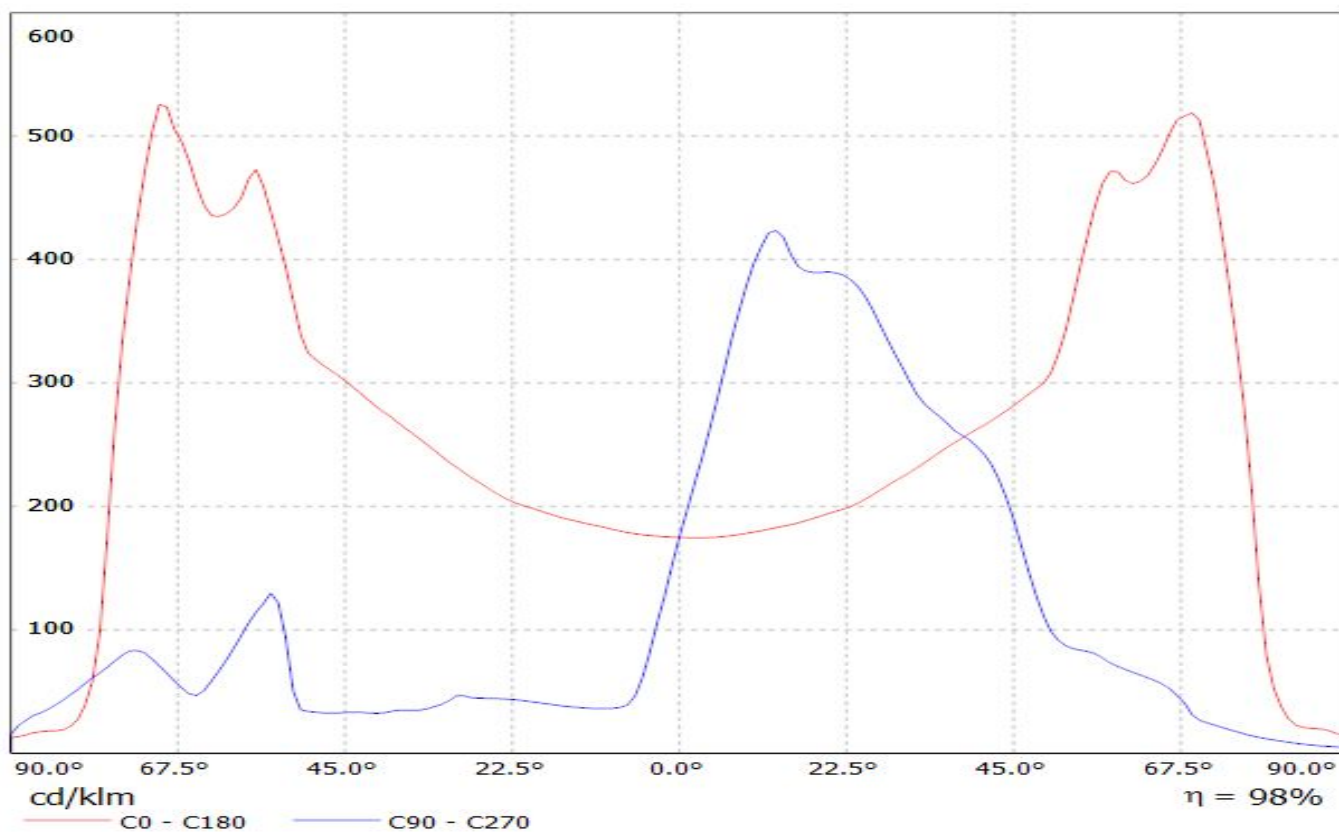

LEDiL Oy C13300_STRADA-2X2-T2_(LUXEON_R) Eff.95.8% / LDC (Linear)

Luminaire: LEDiL Oy C13300_STRADA-2X2-T2_(LUXEON_R) Eff.95.8%

Lamps: 1 x LUXEON_R (303lm@250mA)

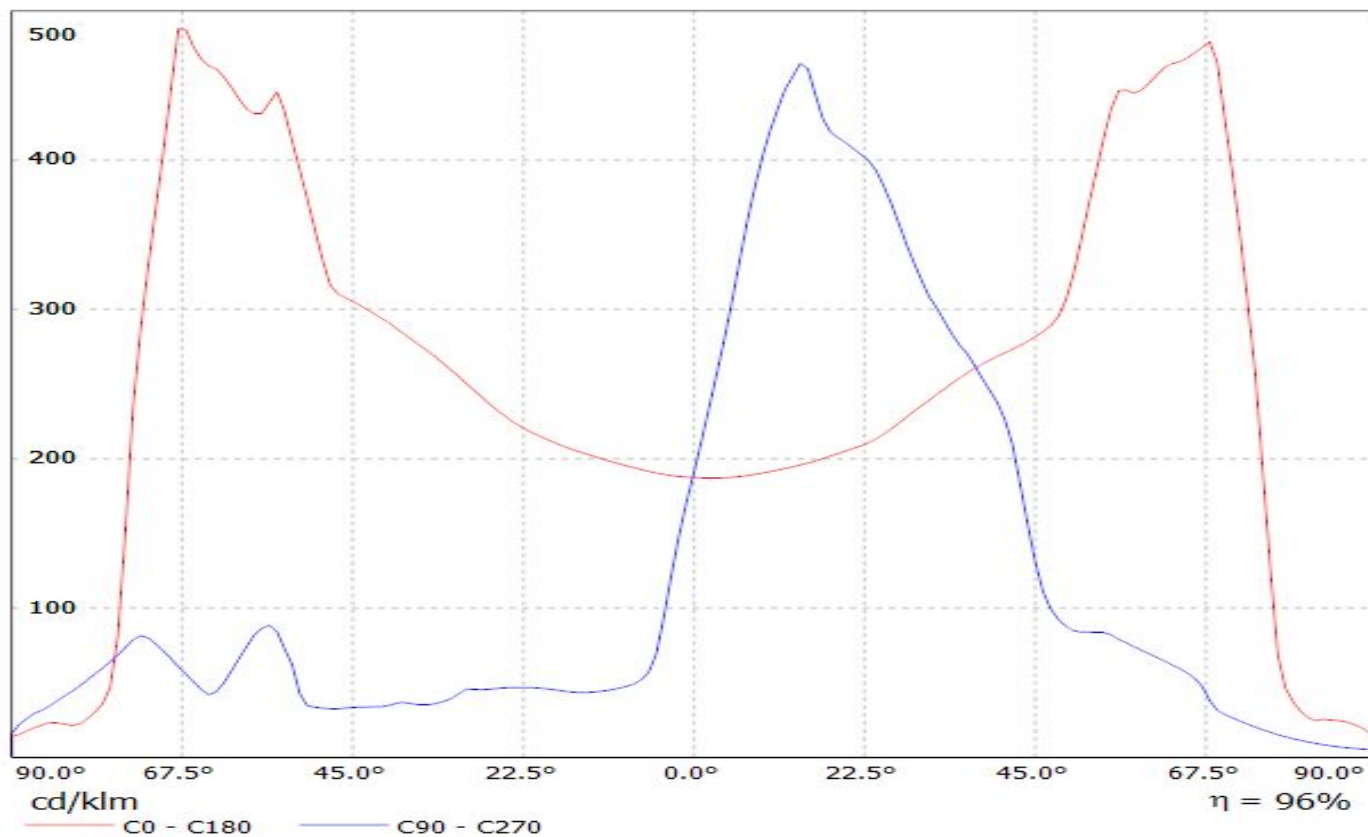

LEDiL Oy C13300_STRADA-2X2-T2_(REBEL_ES) Eff.94.5% / LDC (Linear)

Luminaire: LEDiL Oy C13300_STRADA-2X2-T2_(REBEL_ES) Eff.94.5%
Lamps: 1 x XM-L (338lm@250mA)

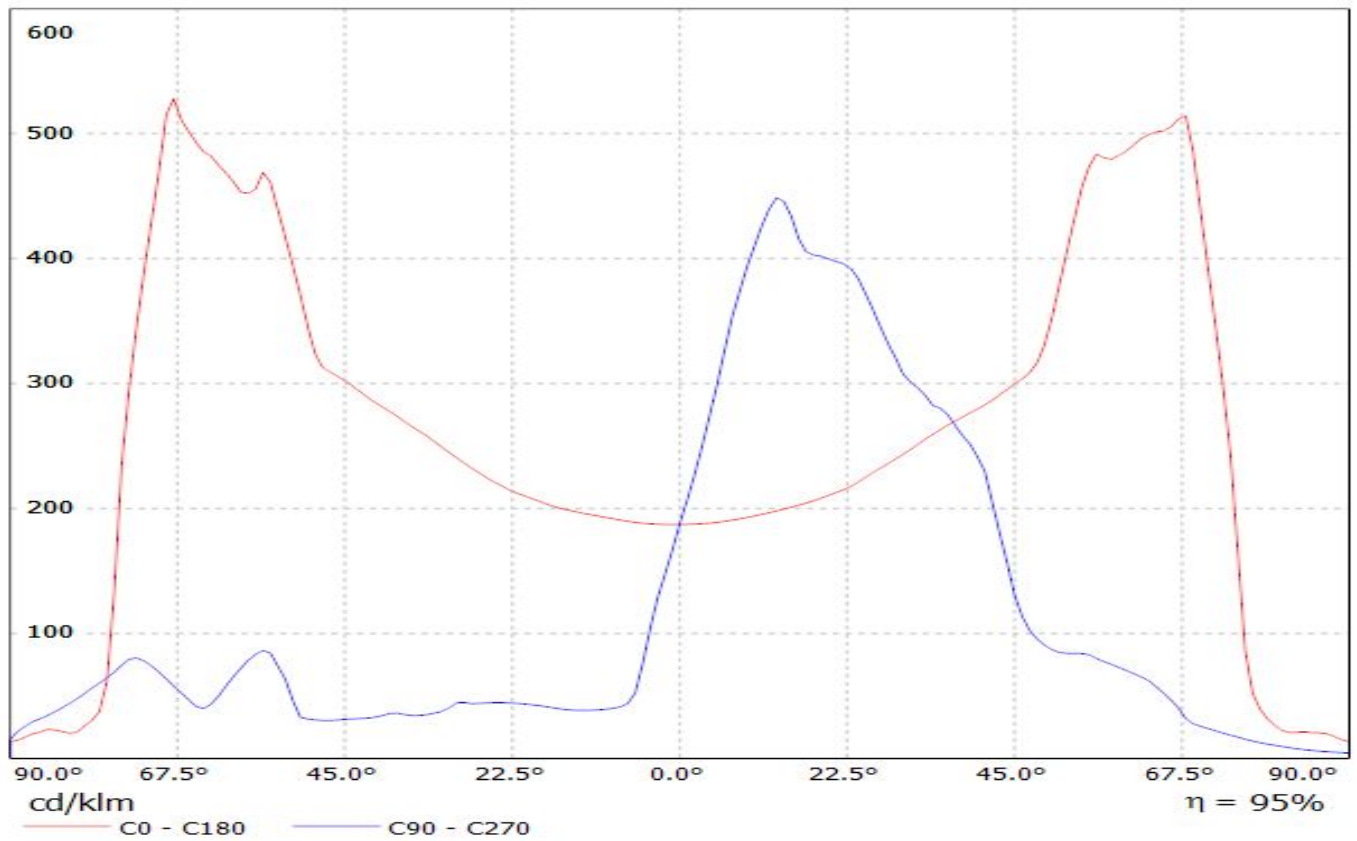

Luminaire: LEDiL Oy C13300_STRADA-2X2-T2 Eff.94.4%
Lamps: 1 x Osram Square PC (399lm@250mA)

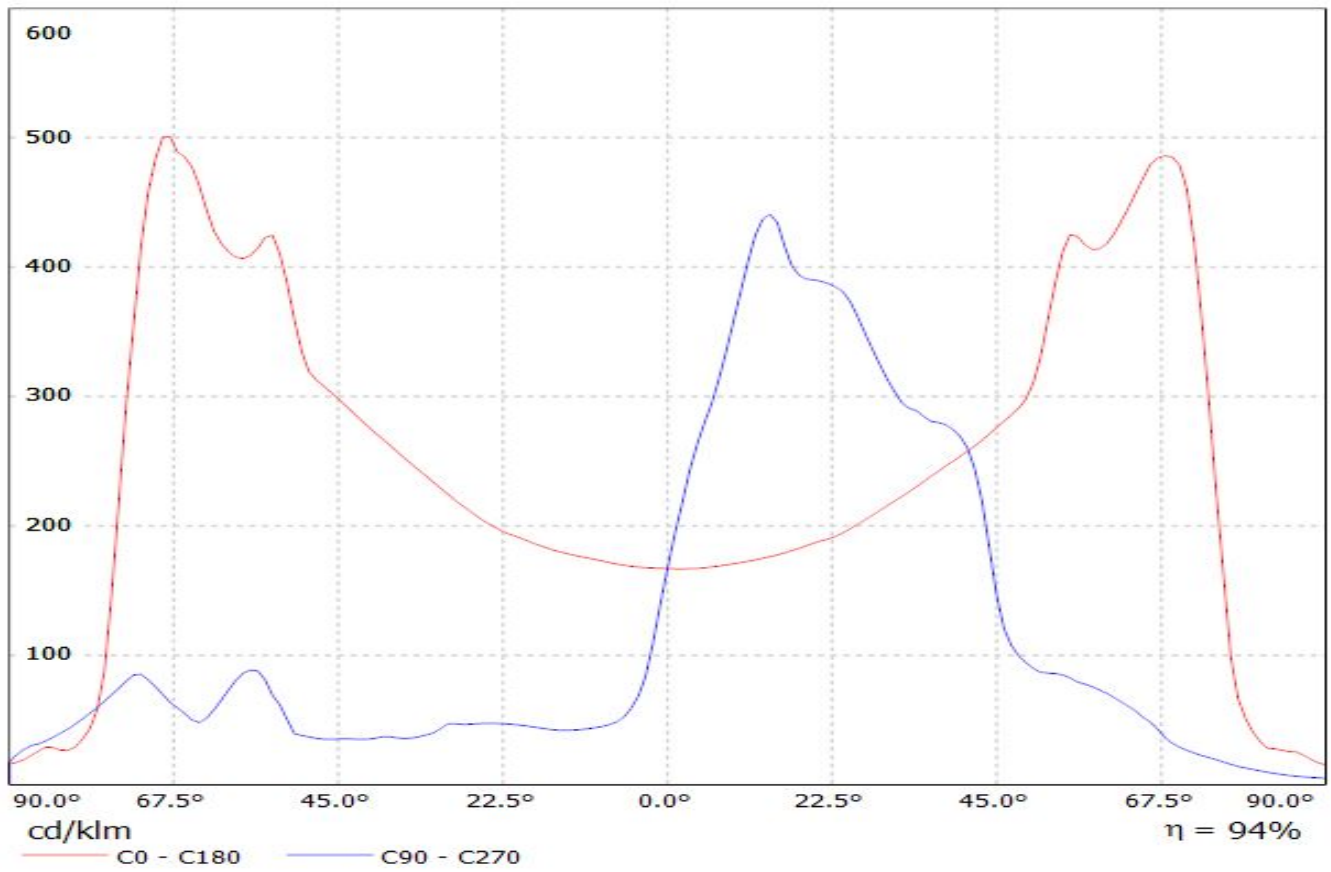

LEDiL Oy C13300_STRADA-2X2-T2_(XM-L) Eff.95.1% / LDC (Linear)

Luminaire: LEDiL Oy C13300_STRADA-2X2-T2_(XM-L) Eff.95.1%
Lamps: 1 x XM-L (357lm@250mA)

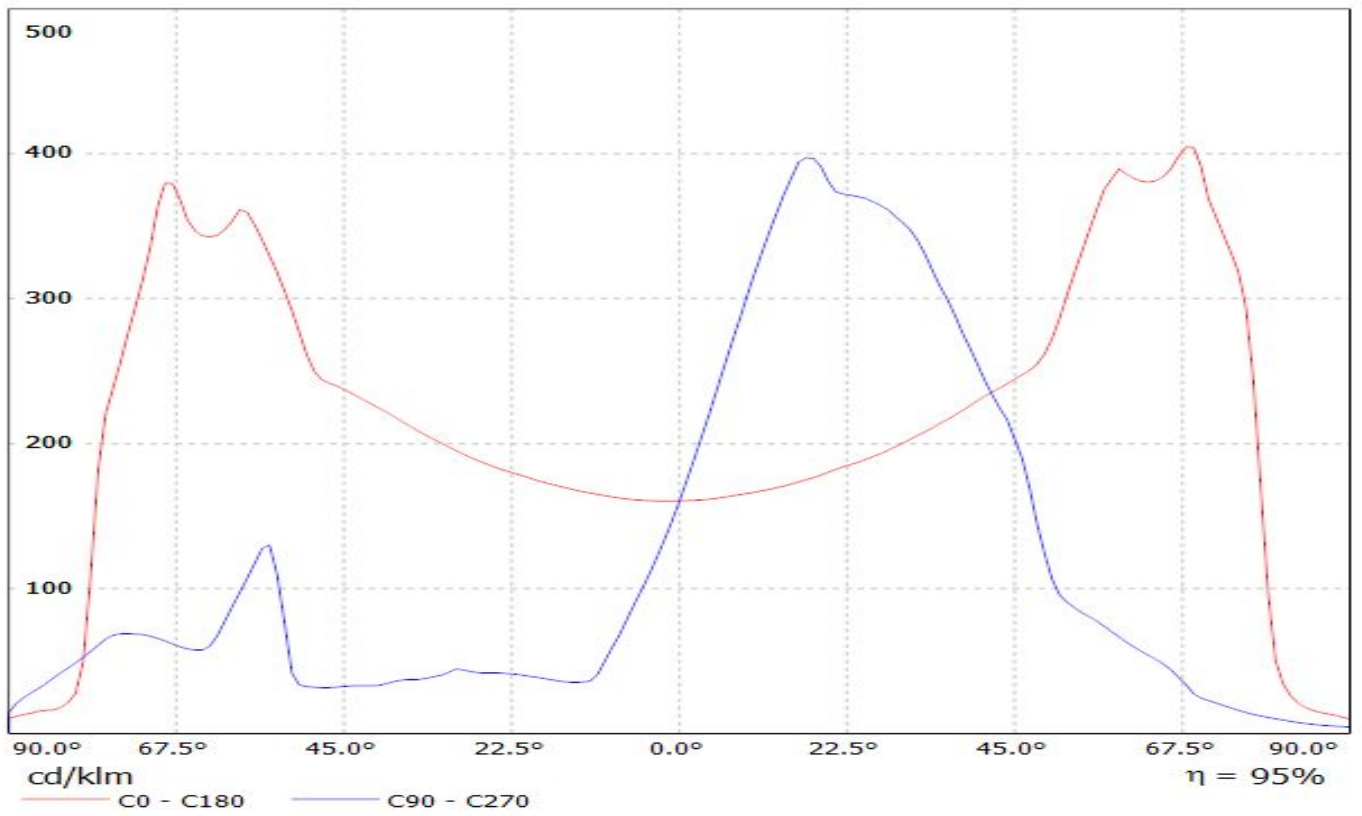

LEDiL Oy C13300_STRADA-2X2-T2_(XB-D) Eff.94.2% / LDC (Linear)

Luminaire: LEDiL Oy C13300_STRADA-2X2-T2_(XB-D) Eff.94.2%
Lamps: 1 x XM-L (370lm@250mA)

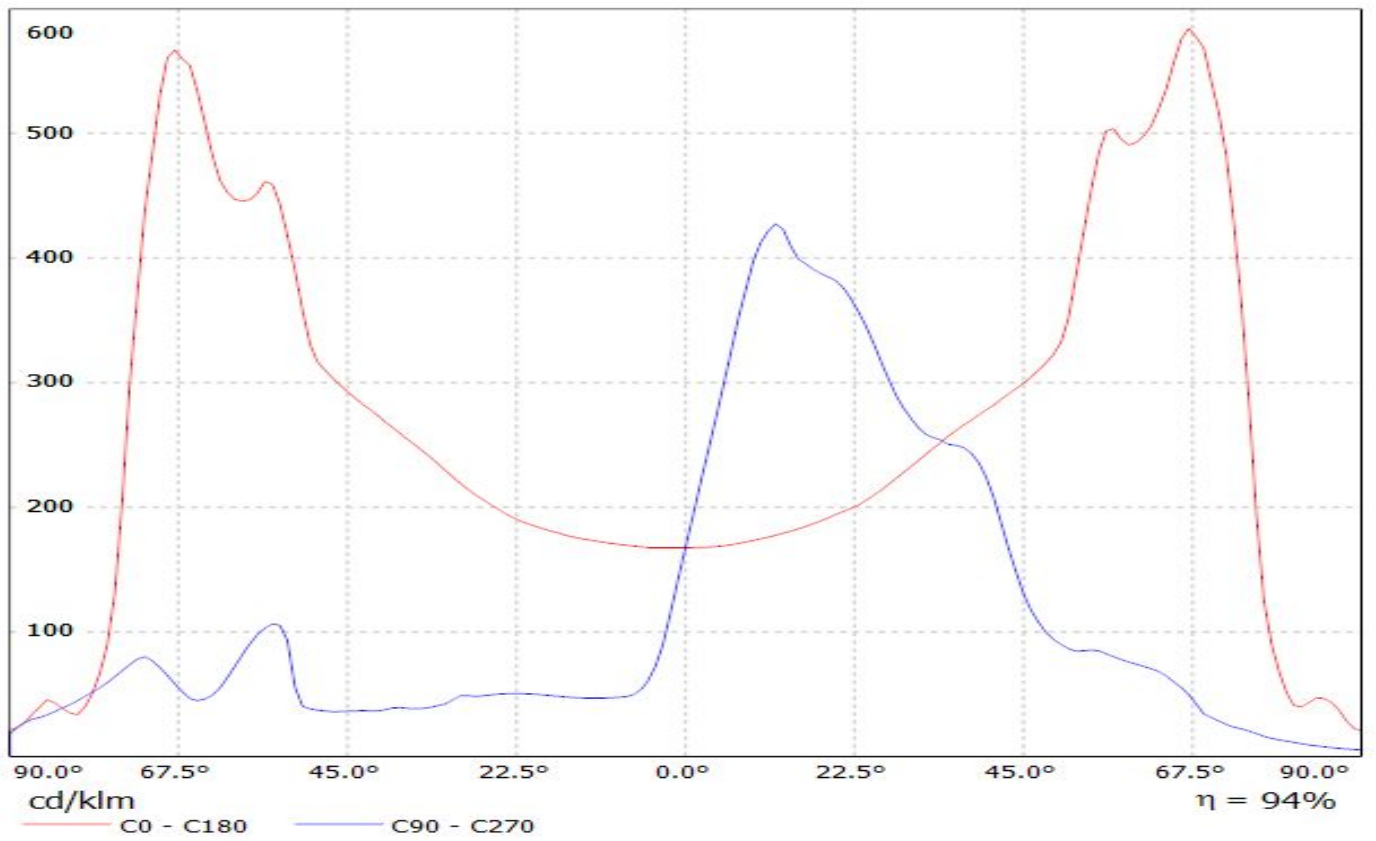

LEDiL Oy C13300_STRADA-2X2-T2_(XP-G2) Eff.90.9% / LDC (Linear)

Luminaire: LEDiL Oy C13300_STRADA-2X2-T2_(XP-G2) Eff.90.9%

Lamps: 1 x XP-G2 (433lm@250mA)

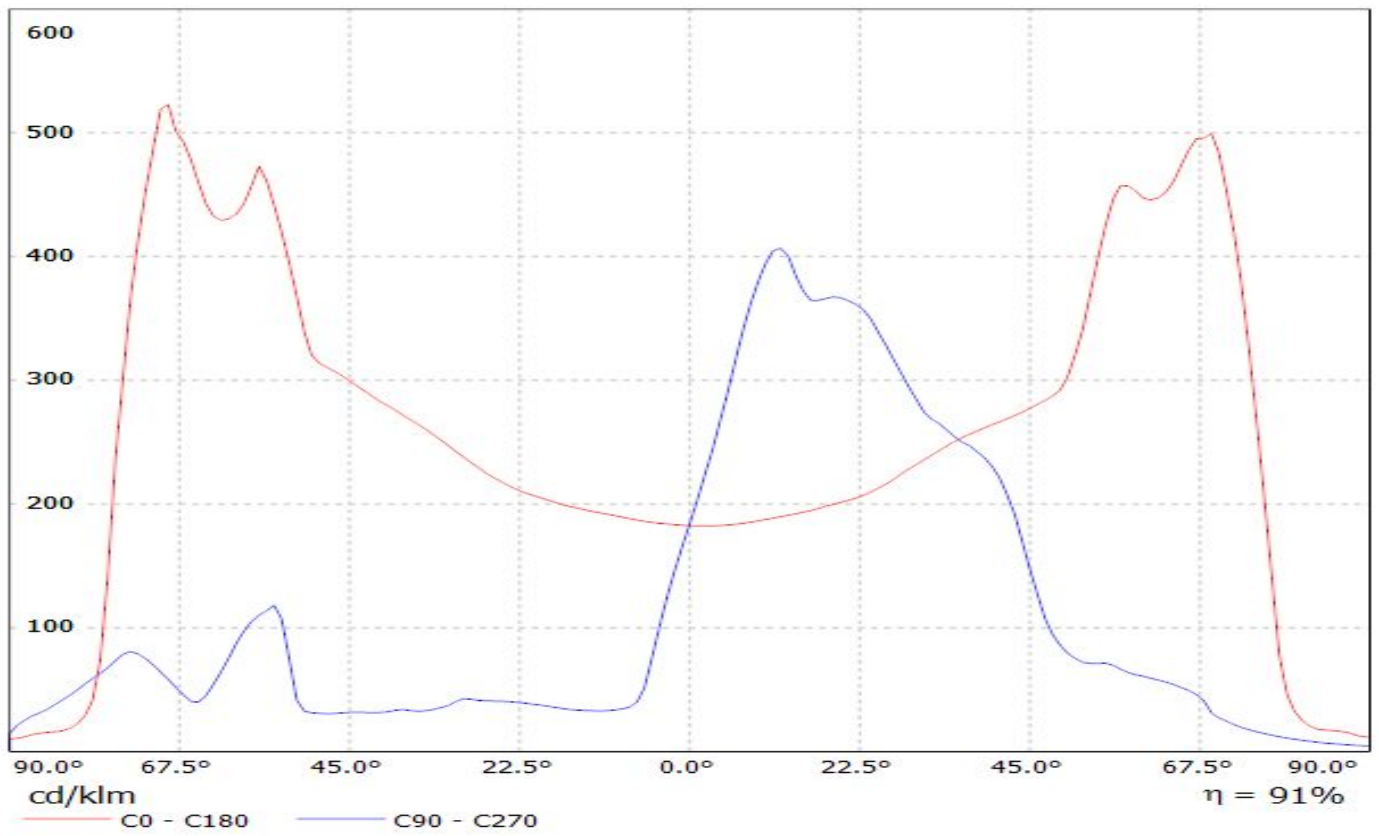

LEDiL Oy C13300_STRADA-2X2-T2_(XM-L2) Eff.94.5% / LDC (Linear)

Luminaire: LEDiL Oy C13300_STRADA-2X2-T2_(XM-L2) Eff.94.5%

Lamps: 1 x XM-L2 (366lm@250mA)

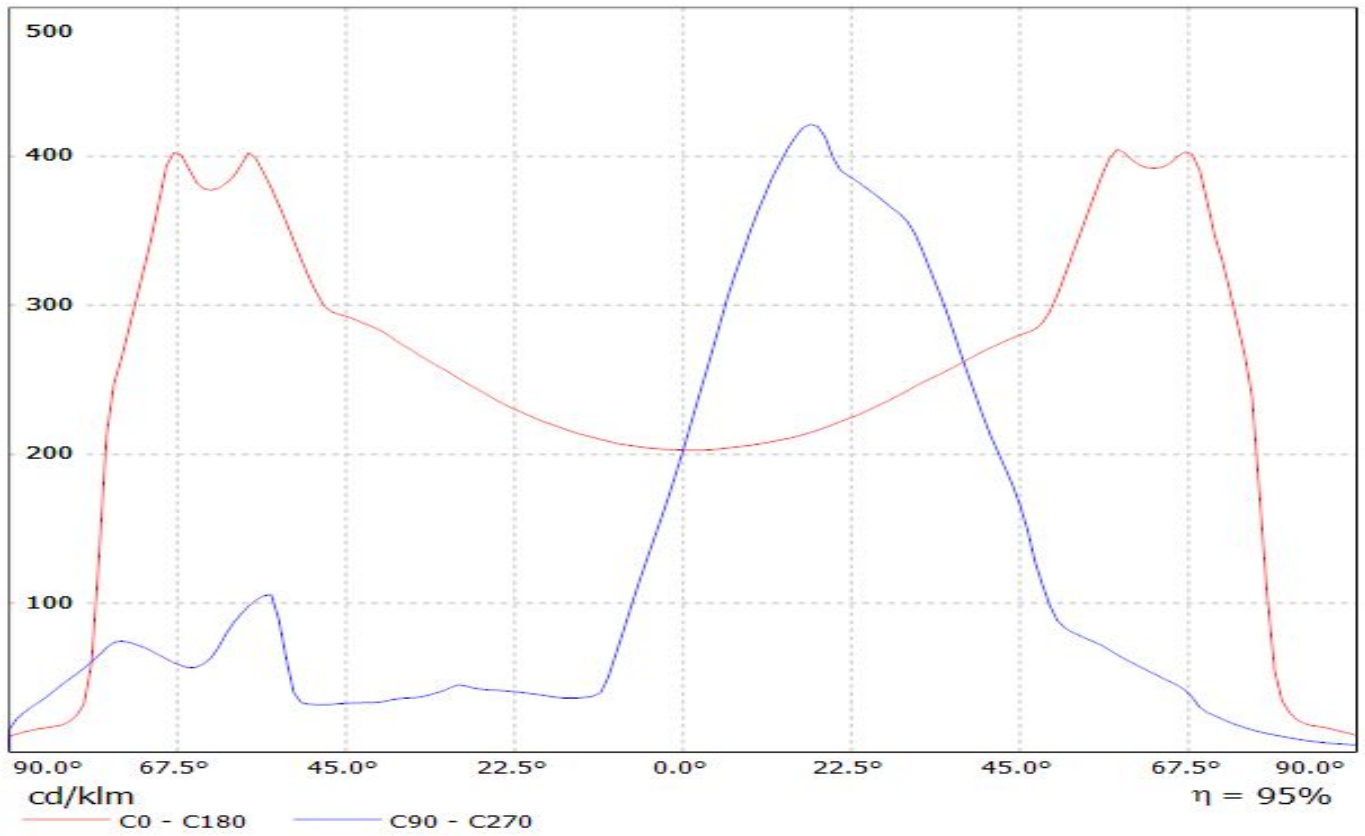

Luminaire: LEDiL Oy C13300_STRADA-2x2-T2_(LUXEON_T) Eff.94.1%
Lamps: 1 x LUXEON_T 2x2 (294lm@250mA)

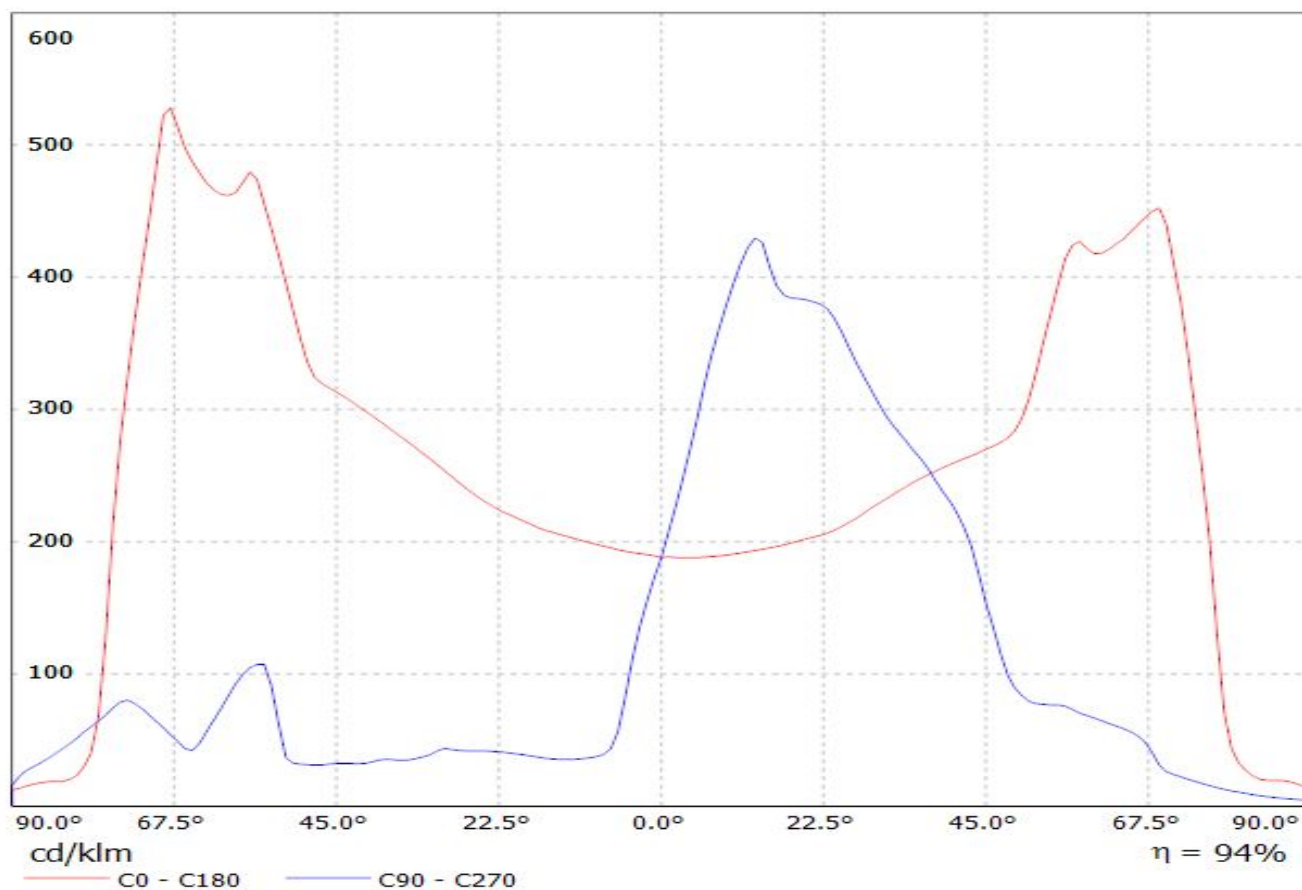

LEDiL Oy C13300_STRADA-2X2-T2_(LG_3535) Eff.94.2% / LDC (Linear)

Luminaire: LEDiL Oy C13300_STRADA-2X2-T2_(LG_3535) Eff.94.2%

Lamps: 1 x LG_3535_Ceramic_2x2 (374lm@250mA)

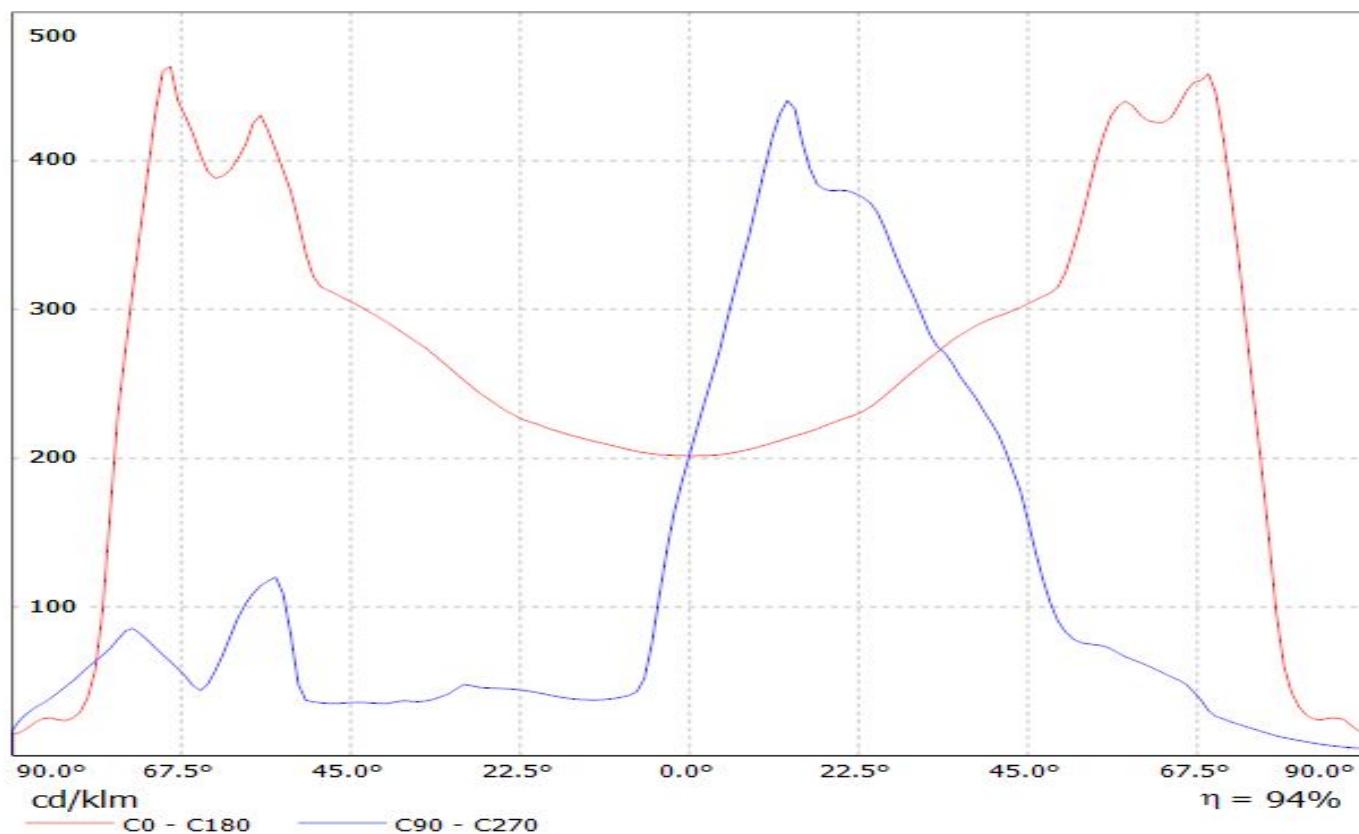

**LEDiL Oy C13300_STRADA-2x2-T2_(NICHIA_NS9x383) Eff.95.4% / LDC
(Linear)**

Luminaire: LEDiL Oy C13300_STRADA-2x2-T2_(NICHIA_NS9x383) Eff.95.4%
Lamps: 1 x NICHIA_NS9x383 (287.074lm@250mA)

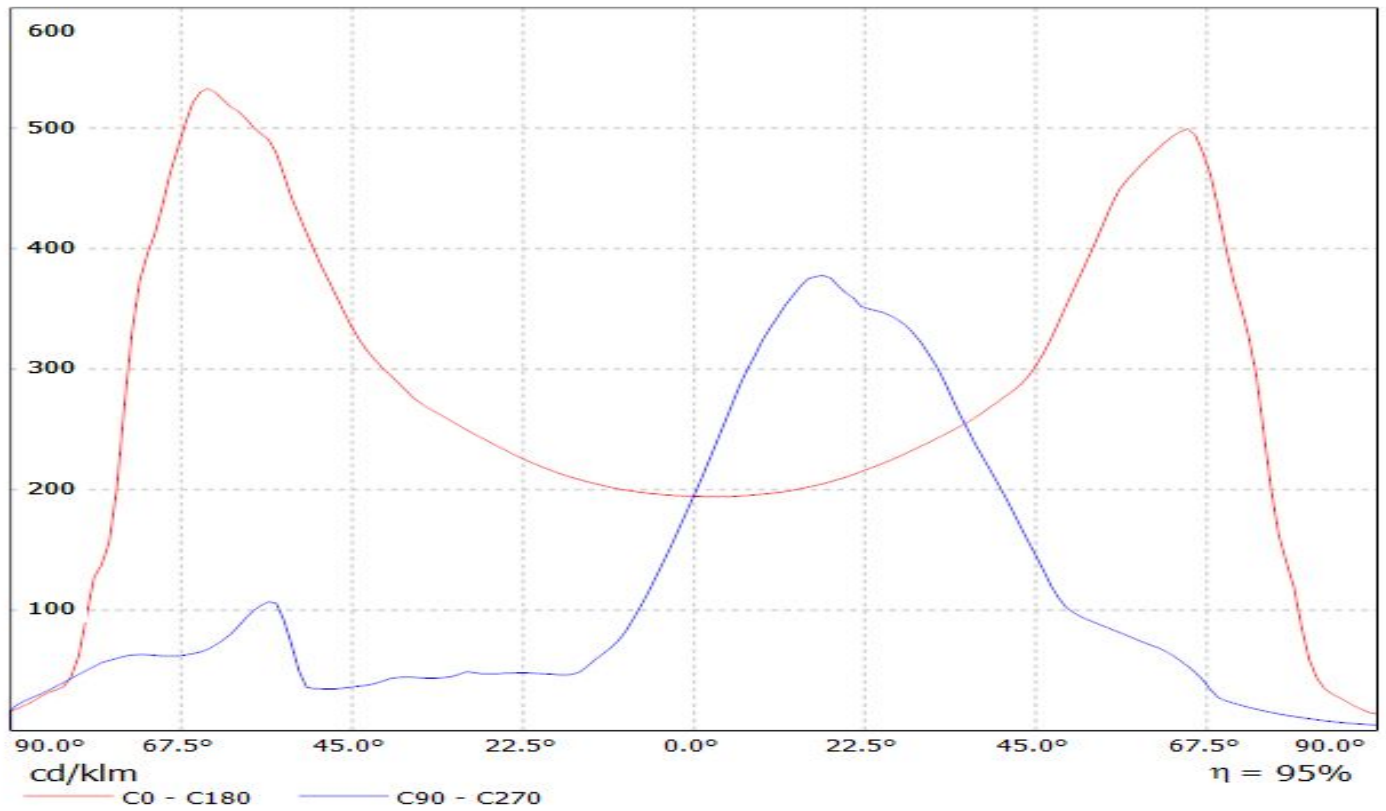

Luminaire: LEDiL Oy C13300_STRADA-2x2-T2_(MJT4040) Eff. 94%
Lamps: 1 x SEOUL ACRICH MJT4040 (SAW09H0A) 255lm@40mA P=2.37W I=40mA

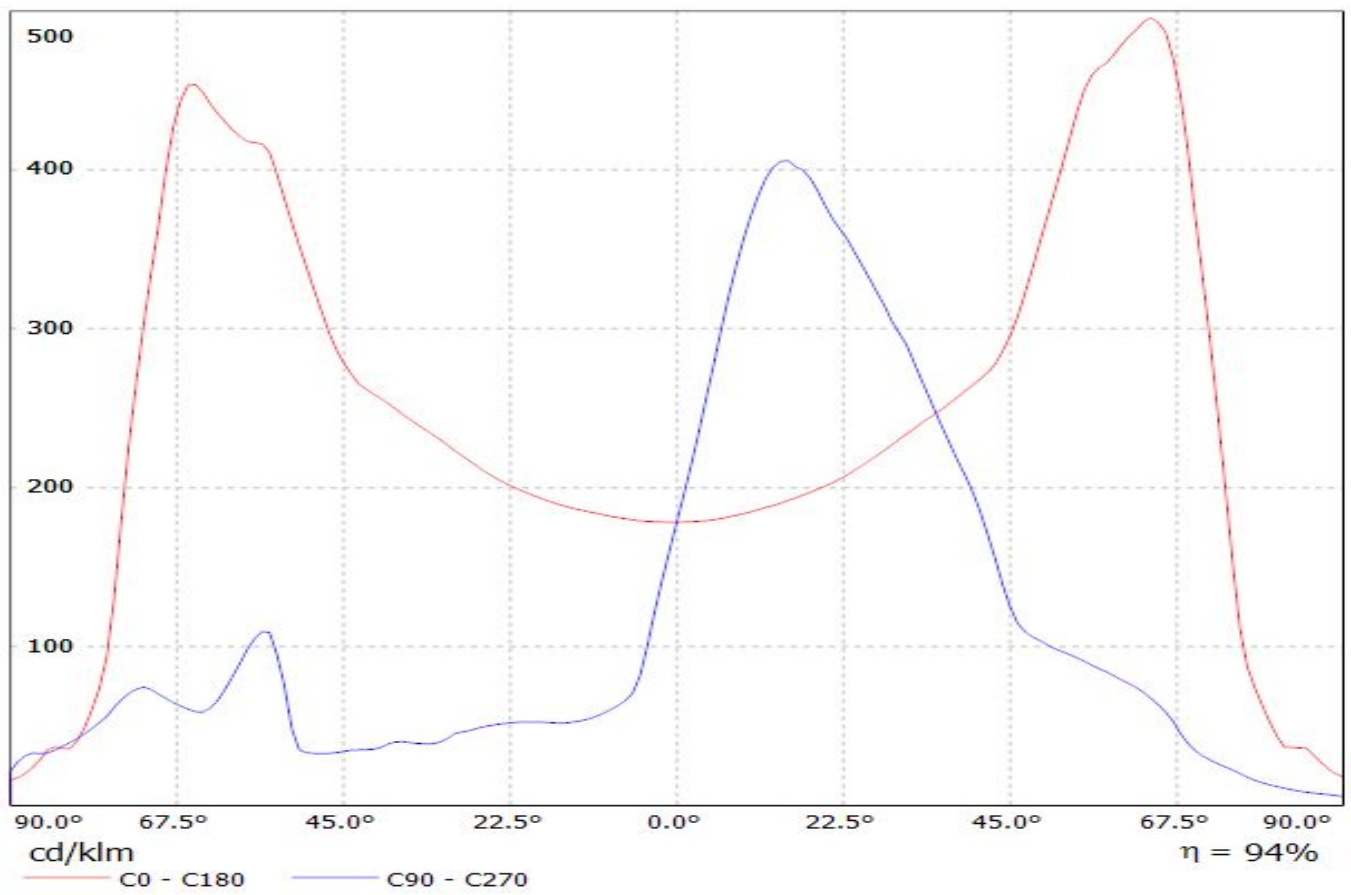

**LEDiL Oy C13300_STRADA-2X2-T2_(LG-3535-CERAMIC-GEN2) Eff.94.0% / LDC
(Linear)**

Luminaire: LEDiL Oy C13300_STRADA-2X2-T2_(LG-3535-CERAMIC-GEN2) Eff.94.0%

Lamps: 1 x LG-3535-CERAMIC-GEN2_2x2_472.9lm@250mA_P=2.8651W_CCT=6562K_I=249.9mA

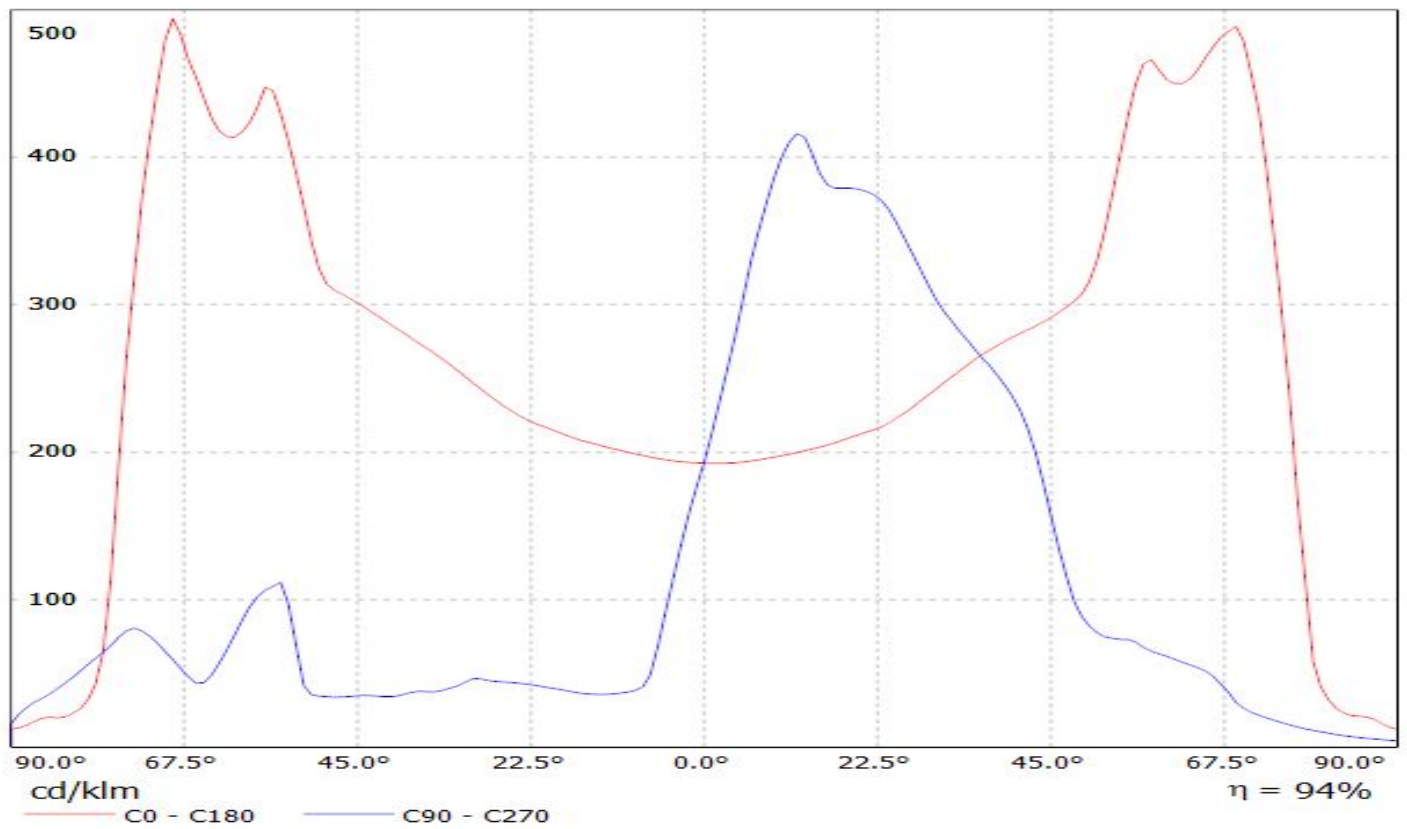

Luminaire: LEDiL Oy C13300_STRADA-2X2-T2_(Luxeon-Z-ES) Eff: 94%
Lamps: 1 x Luxeon Z ES 2x2 (LXZ2-3090) 209.277lm@250mA_P=2.81W_I=0.2499A

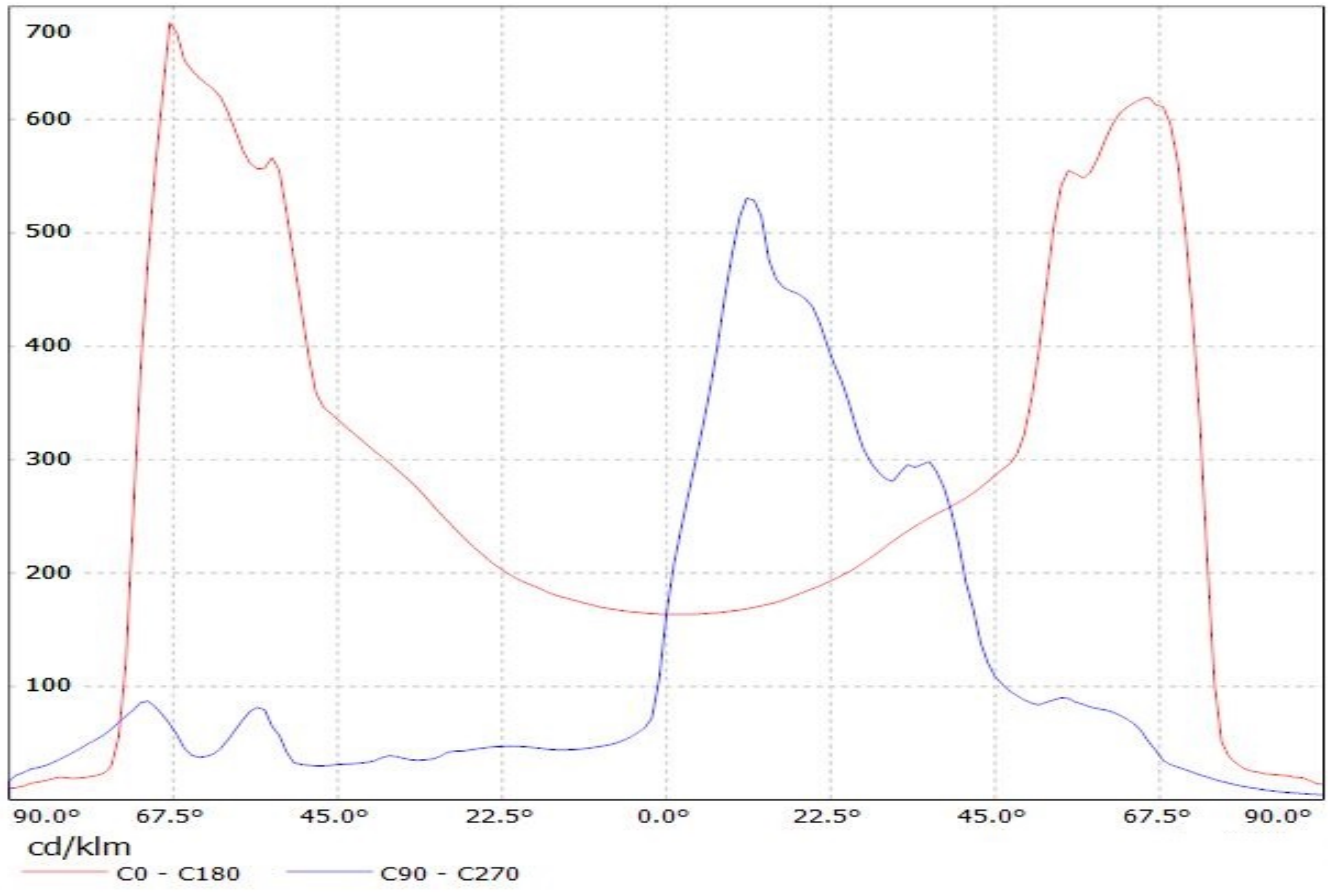

Luminaire: LEDiL Oy C13300_STRADA-2X2-T2_(LUXEON_Q)

Lamps: 1 x LUXEON_Q_2x2_(LHQ-3080)_298.363lm@250mA_P=2.87385W_I=249.9mA

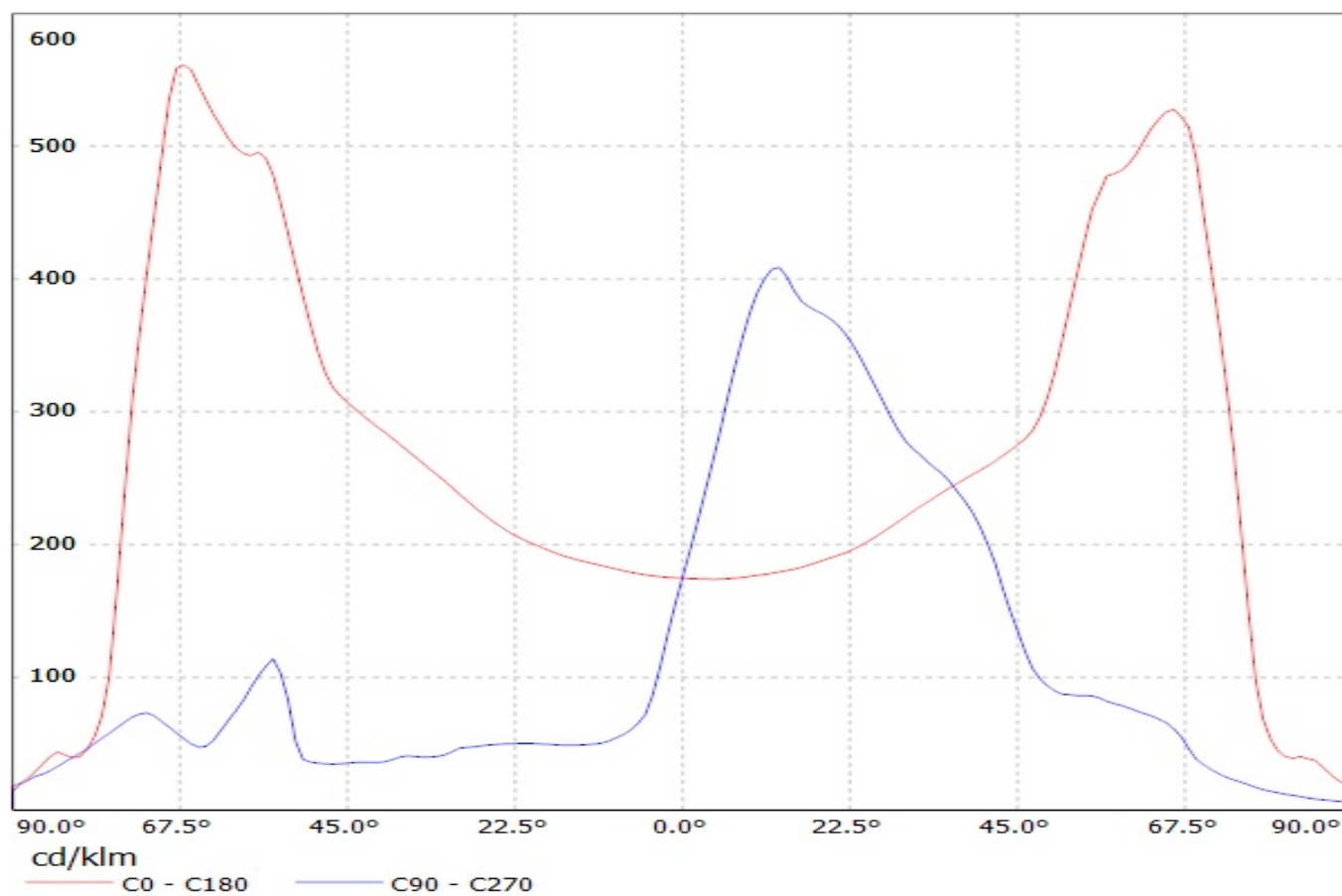

Luminaire: LEDil Oy C13300_STRADA-2X2-T2_(Z5M1) Efficiency=94%
Lamps: 1 x Seoul Z5M1 (SZ5-M1-WN-C8) 379lm @ 250mA CCT=4600K P=2.9W I=250mA

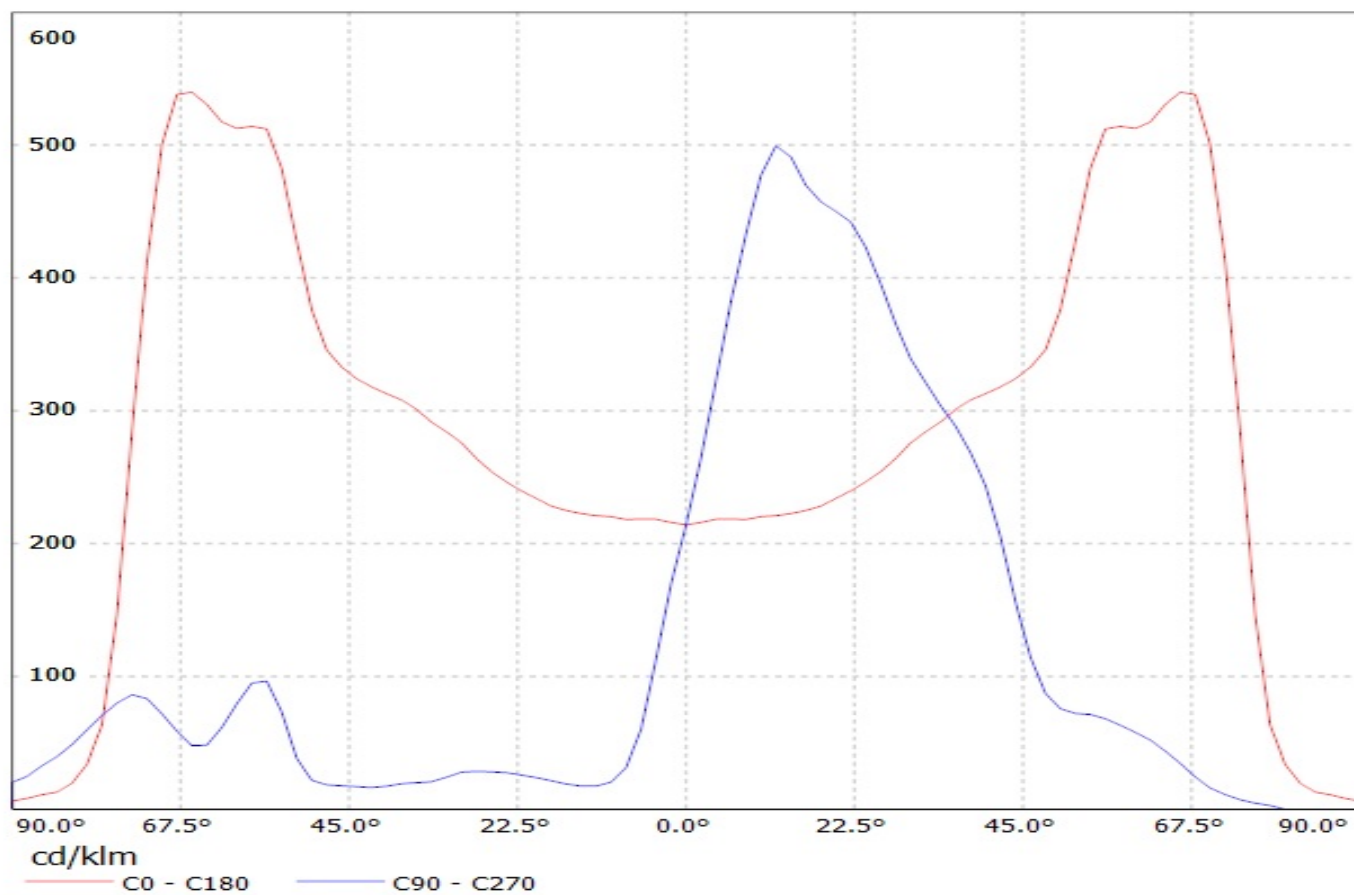

Luminaire: LEDiL Oy C13300_STRADA-2x2-T2_(XP-L)

Lamps: 1 x CREE_XP-L_2x2_(XPLAWT-0-1B0-V40-00-0001)_508.75lm@250mA_CCT=7600K_P=2.79963W_I=249.9mA

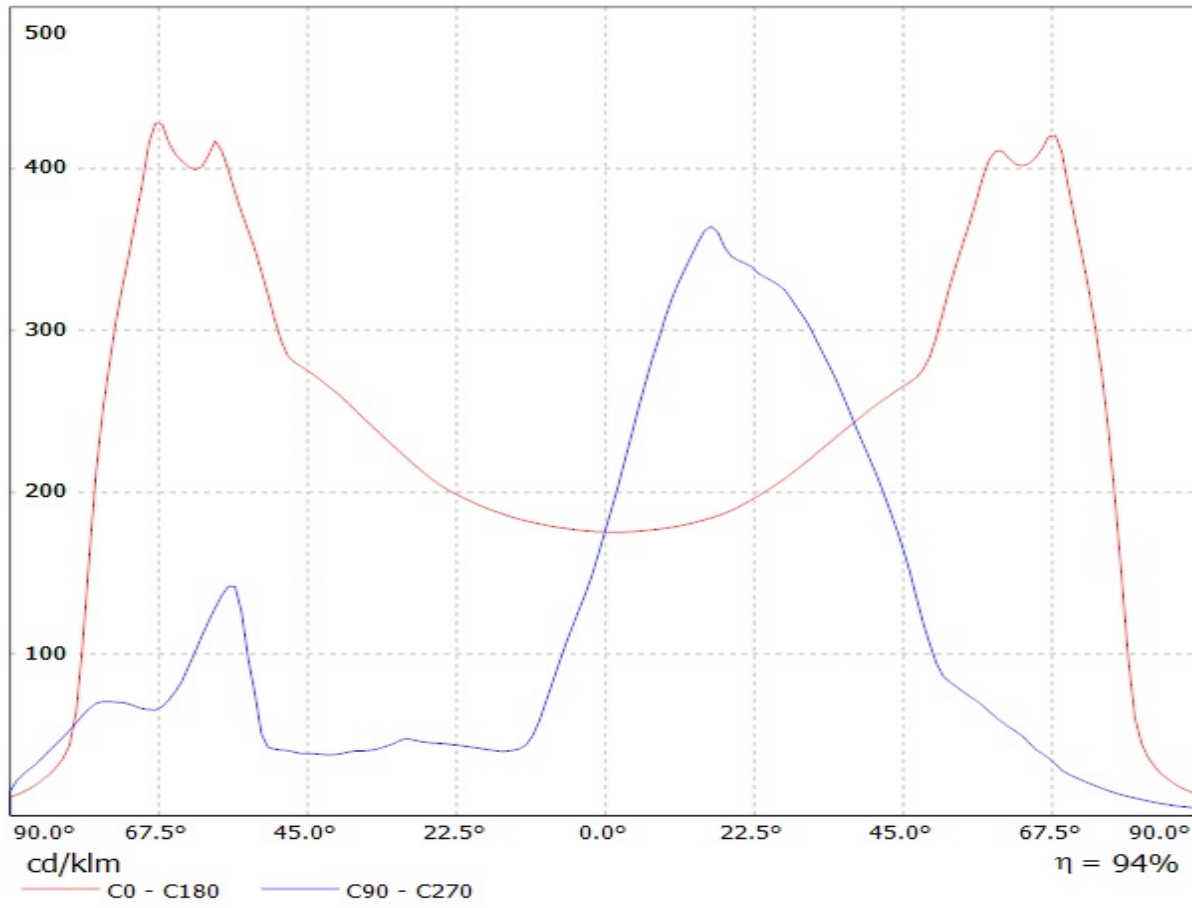

Luminaire: LEDiL Oy C13300_STRADA-2X2-T2_(LUXEON_MZ) Eff.94.0%

Lamps: 1 x LUXEON_MZ_2x2_(LMZ7-QW57)_417.25lm@250mA_P=2.71916W_CCT=5700K_I=249.9mA

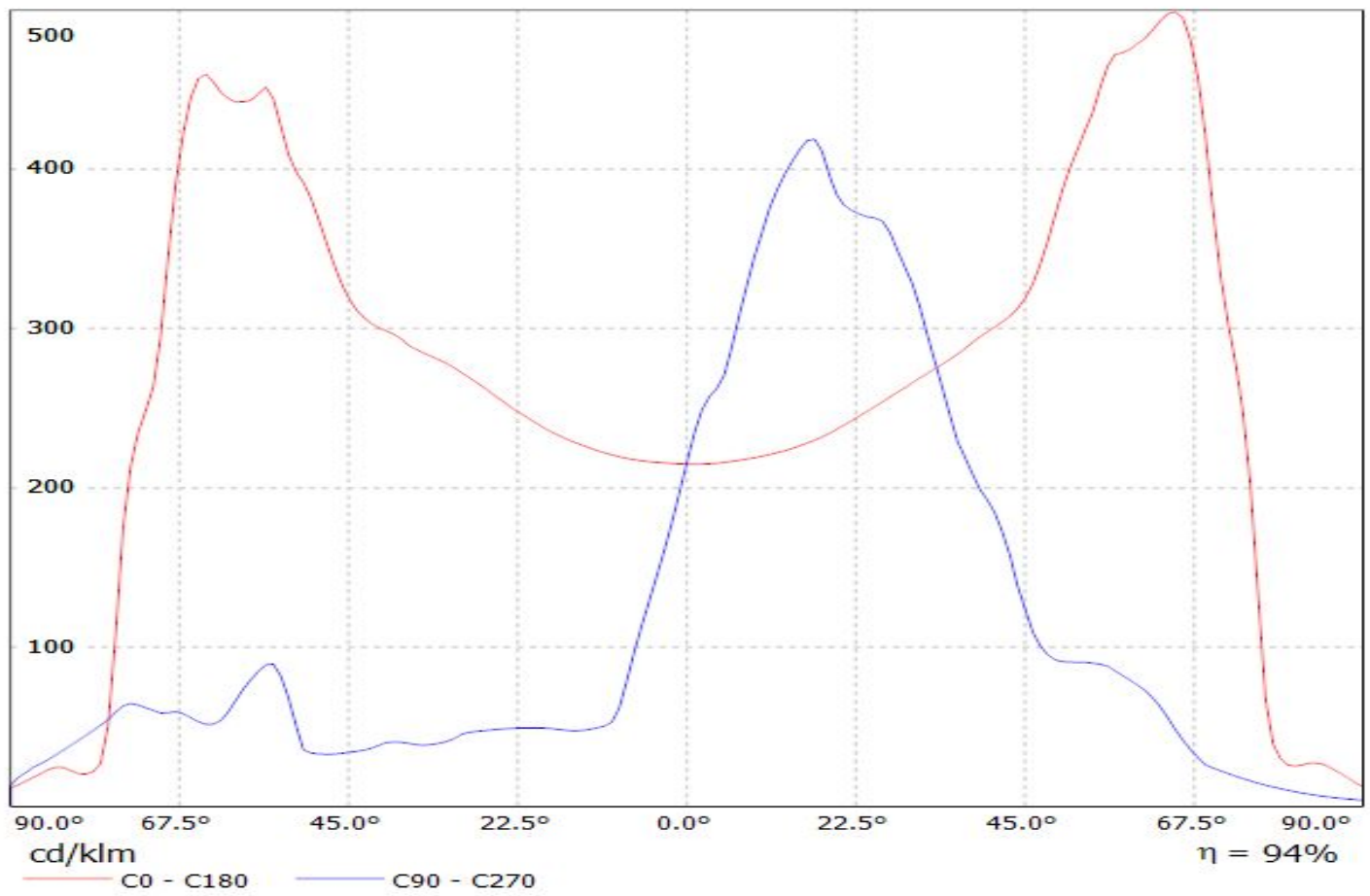

Luminaire: LEDiL Oy C13300_STRADA-2X2-T2_(Luxeon_TX)
Lamps: 1 x Luxeon_TX_2x2_321.384lm@250mA_P=2.79488W_I=249.9mA

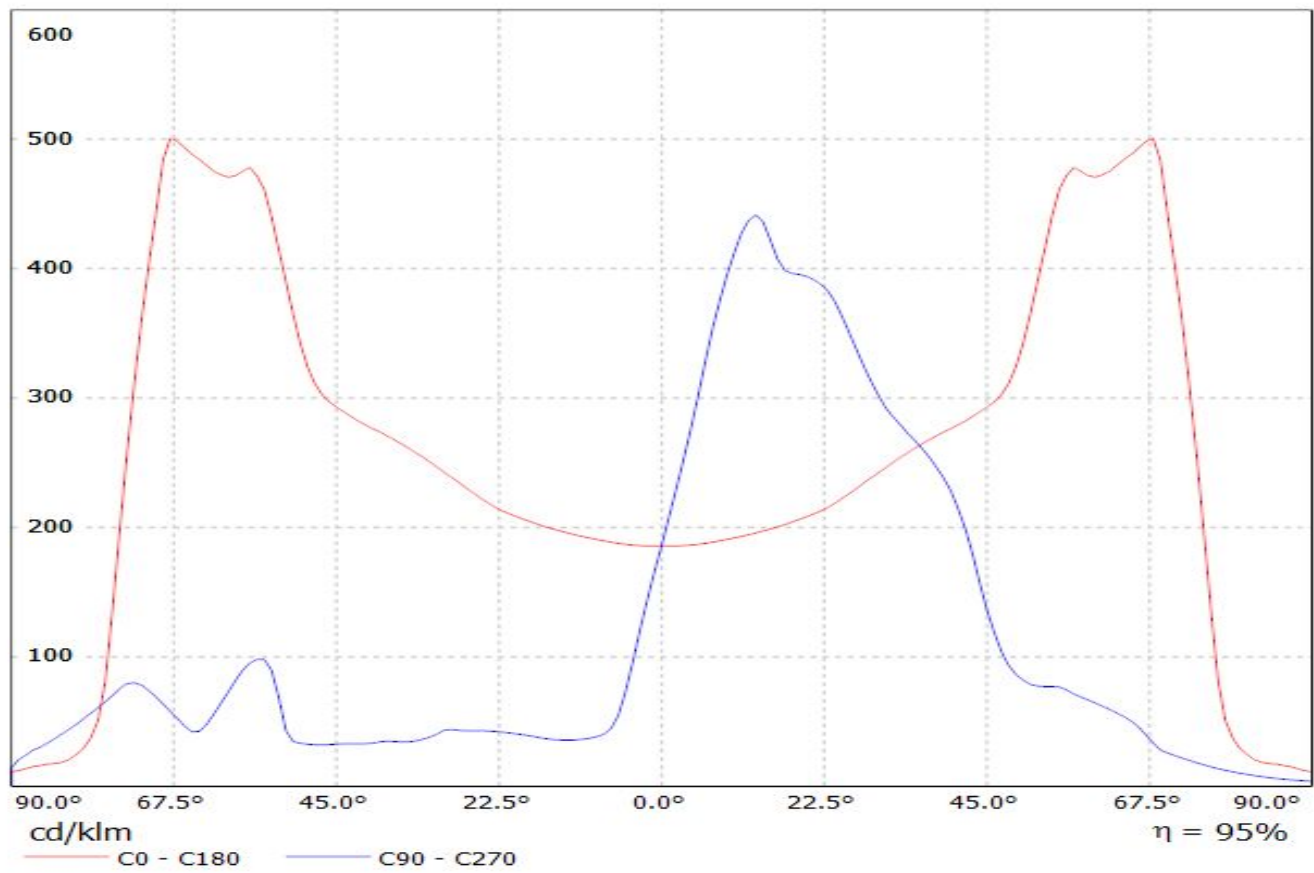

Luminaire: LEDiL Oy C13300_STRADA-2X2-T2_(LH351B)

Lamps: 1 x SAMSUNG_LH351B_2x2_440.73lm@250mA_P=2.84311W_I=249.9mA

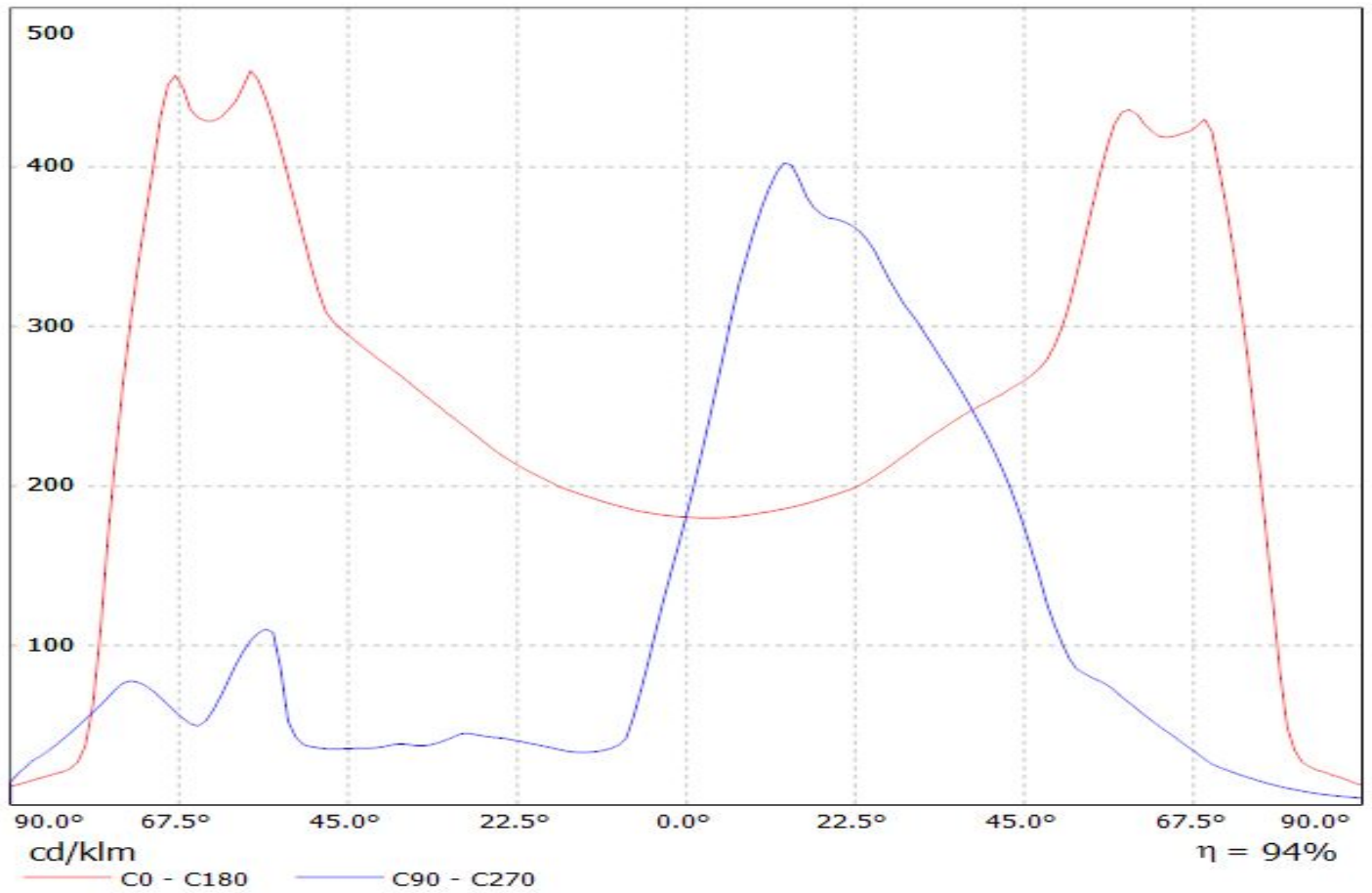

Luminaire: LEDiL Oy C13300_STRADA-2X2-T2_(LH351Z)
Lamps: 1 x SAMSUNG_LH351Z_2x2_365.89lm@250mA_P=2.86371W_I=249.8mA

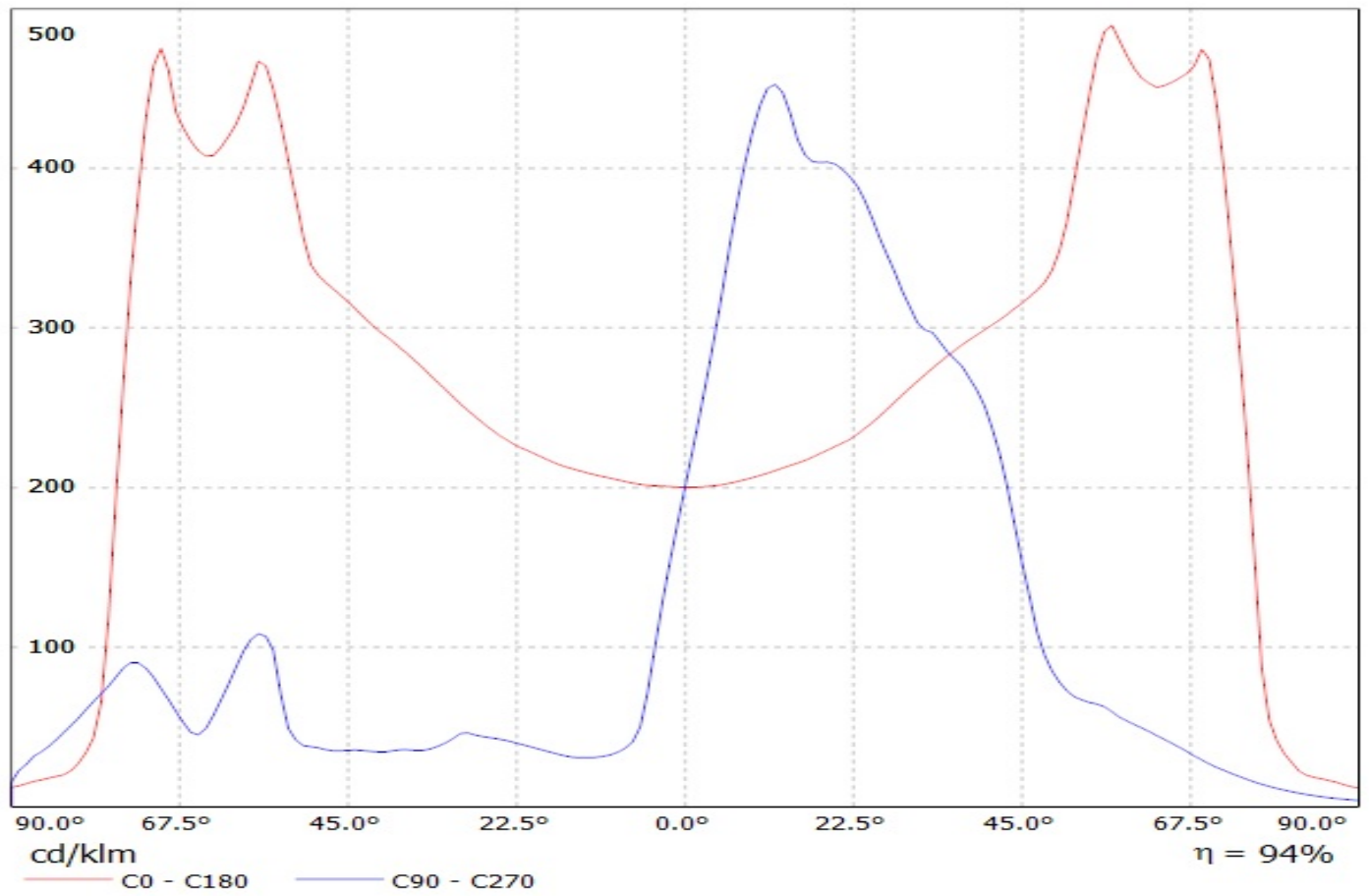

Ledil C13300_STRADA-2X2-T2_(TL1L3) / LDC (Linear)

Luminaire: Ledil C13300_STRADA-2X2-T2_(TL1L3)

Lamps: 1 x Toshiba_TL1L3_2x2_(TL1L3-NW1.L)_387.773lm@250mA_CCT=5000K_P=2.829W_I=0.25A

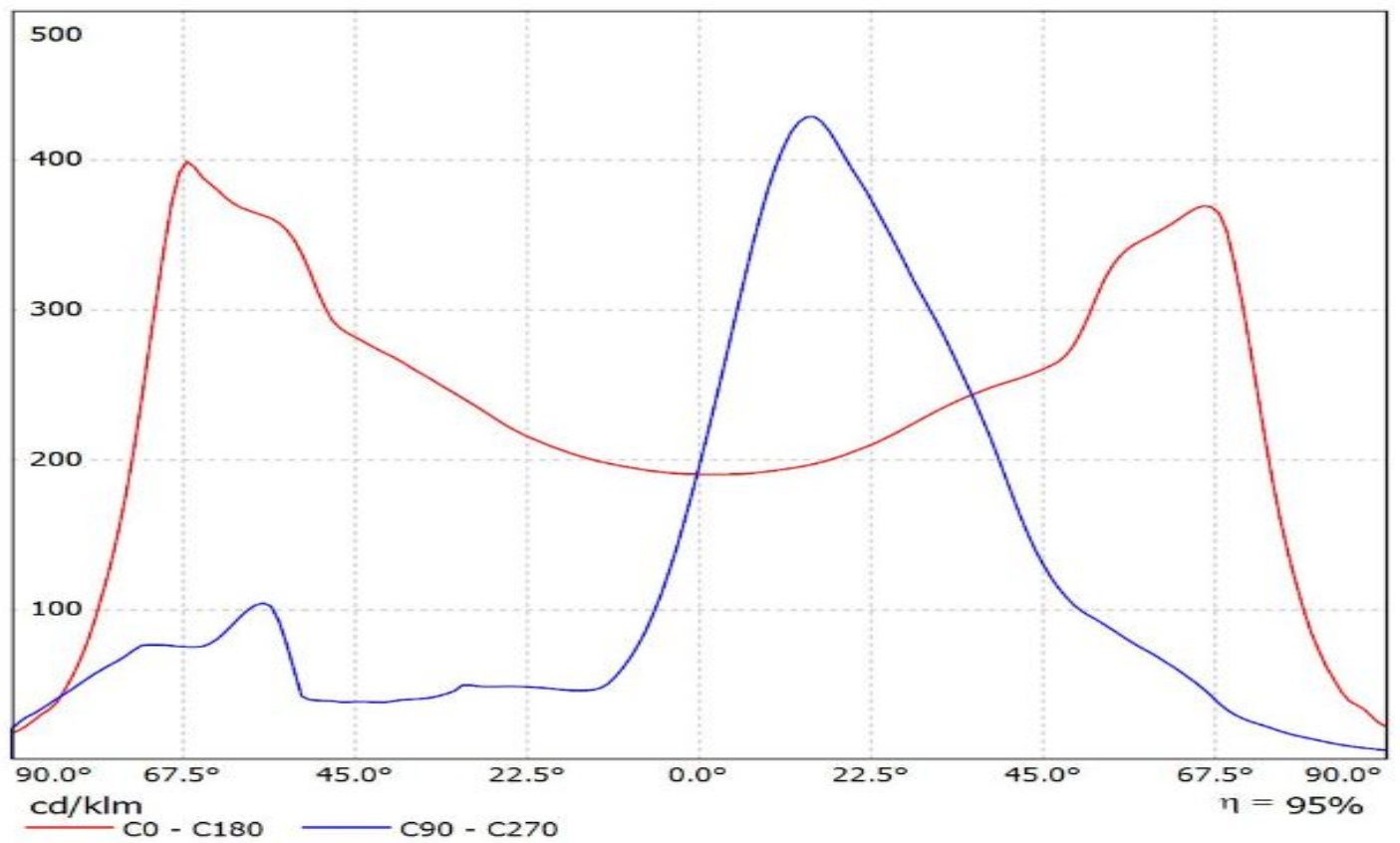

Luminaire: LEDiL Oy C13300_STRADA-2X2-T2_(Fortimo_F-Flex_2x8_740DAG3)

Lamps: 1 x Philips_Fortimo_F-Flex_2x8_740DAG3_1786.86lm@250mA_P=11.6092W_I=0.2498A

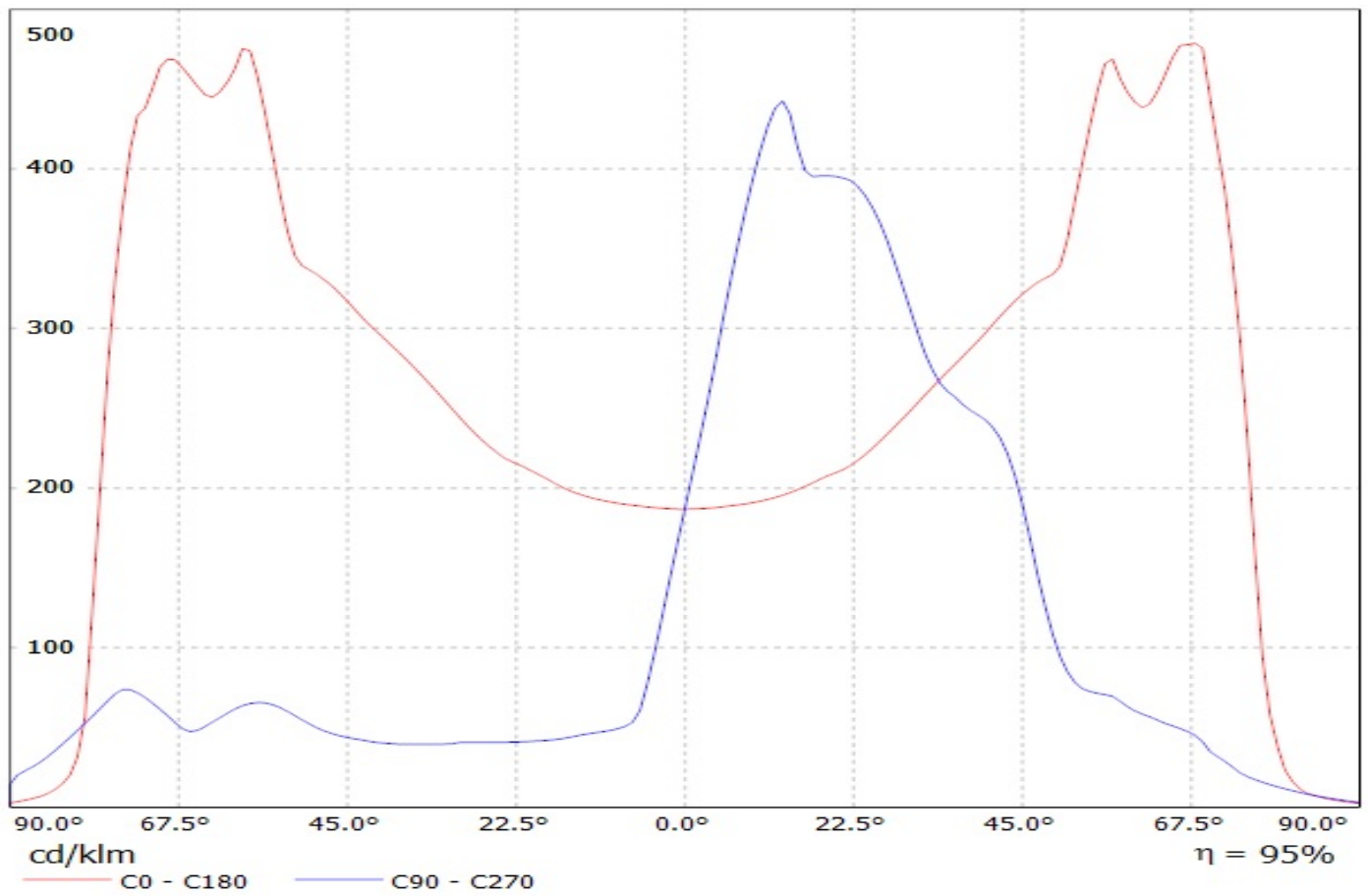

Ledil C13300_STRADA-2X2-T2_(TL1L4) / LDC (Linear)

Luminaire: Ledil C13300_STRADA-2X2-T2_(TL1L4)

Lamps: 1 x Toshiba_TL1L4_2x2_(TL1L4-DW0)_472.639lm@250mA_CCT=6500K_P=2.9W_I=0.25A

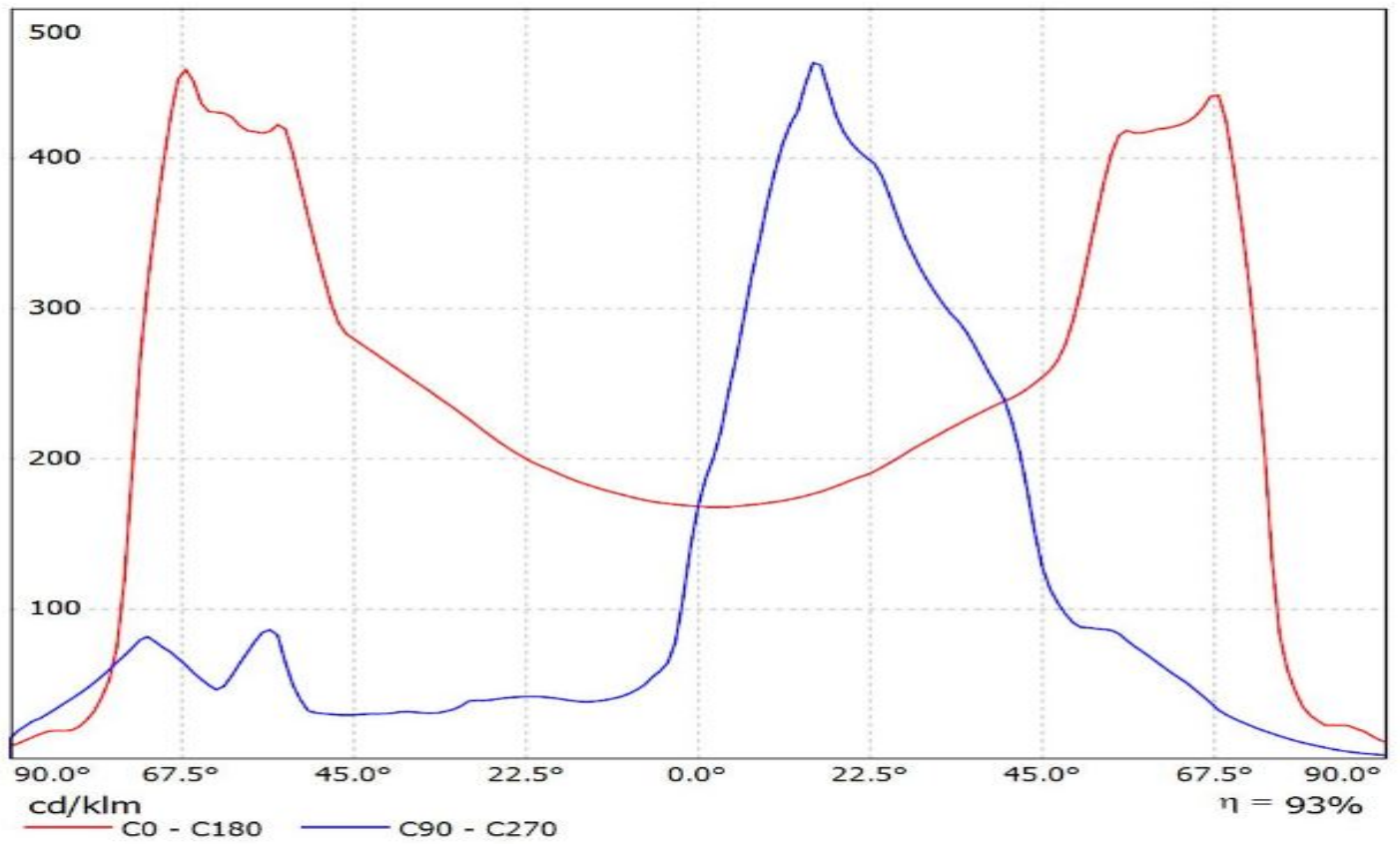

Luminaire: LEDiL Oy C13300_STRADA-2X2-T2_(XP-L_HI)
Lamps: 1 x Cree_XP-L_HI_(2x2)_(XPLAWT-H-5A3-U60-013-0001)
_455.077lm@250mA_P=2.84011W_I=0,2499A

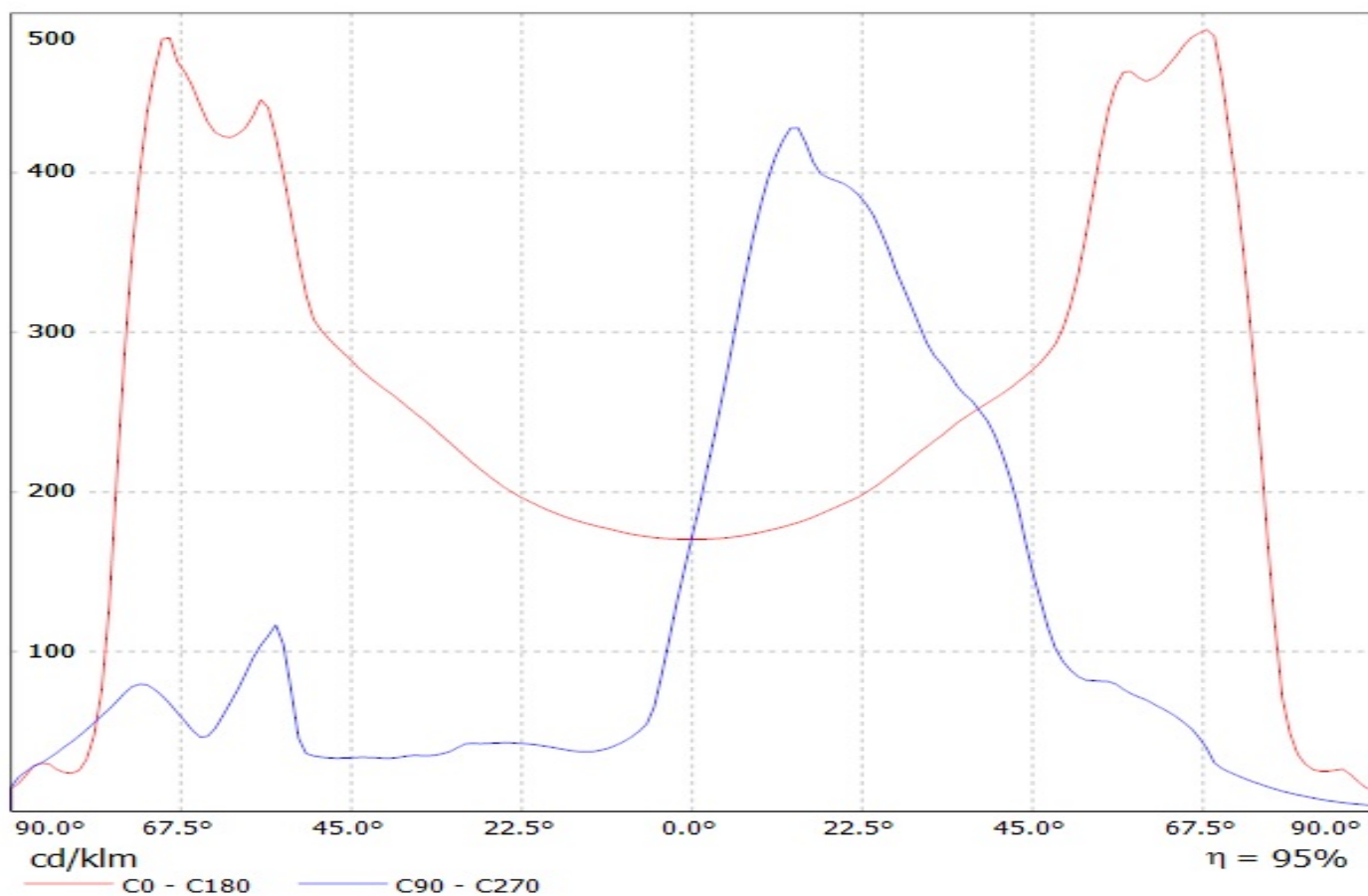

LEDiL Oy C13300_STRADA-2X2-T2_(XP-G) Eff.97.9% / LDC (Polar)

Luminaire: LEDiL Oy C13300_STRADA-2X2-T2_(XP-G) Eff.97.9%

Lamps: 1 x XP-G (249lm@250mA)

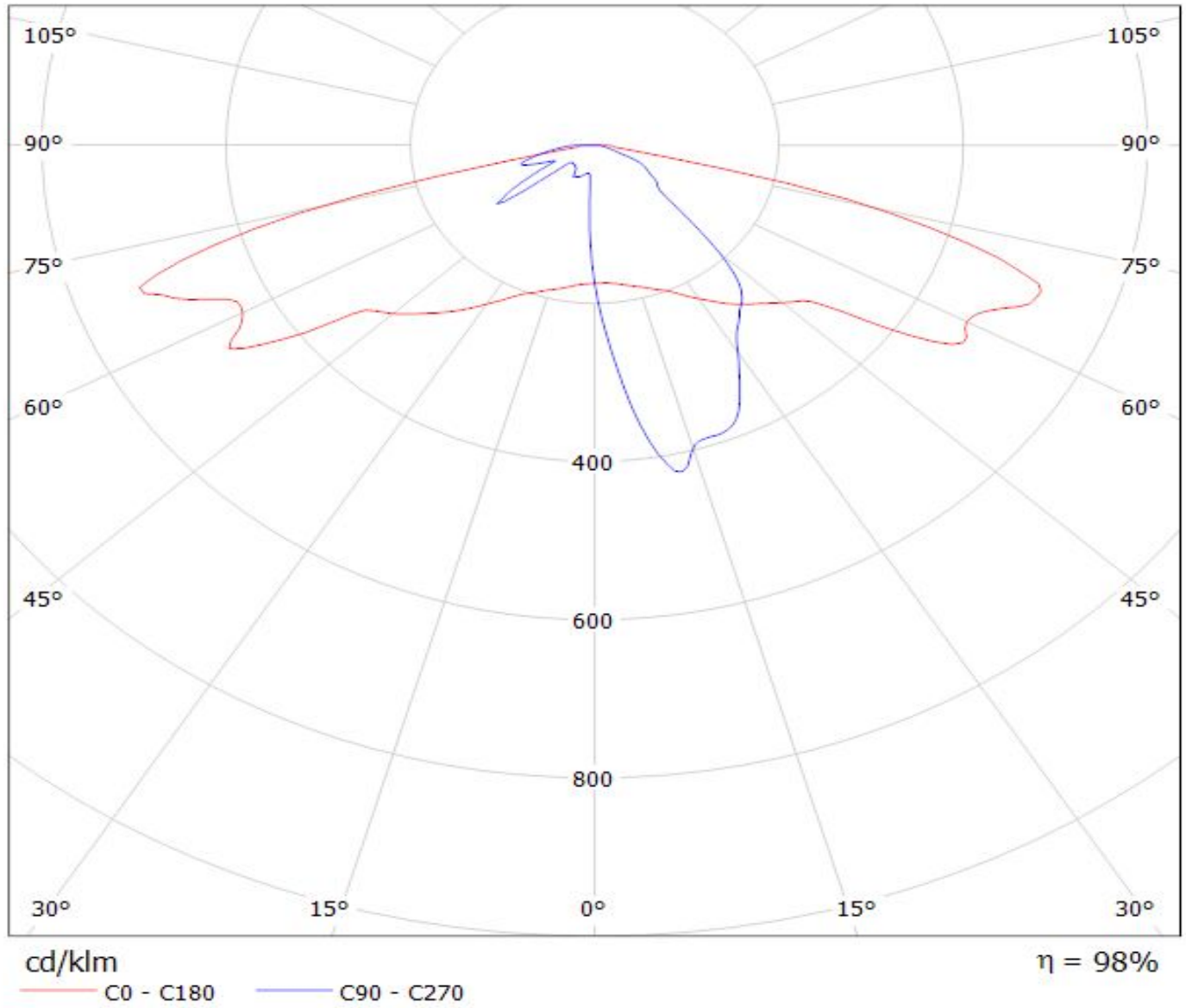

LEDiL Oy C13300_STRADA-2X2-T2_(LUXEON_R) Eff.95.8% / LDC (Polar)

Luminaire: LEDiL Oy C13300_STRADA-2X2-T2_(LUXEON_R) Eff.95.8%
Lamps: 1 x LUXEON_R (303lm@250mA)

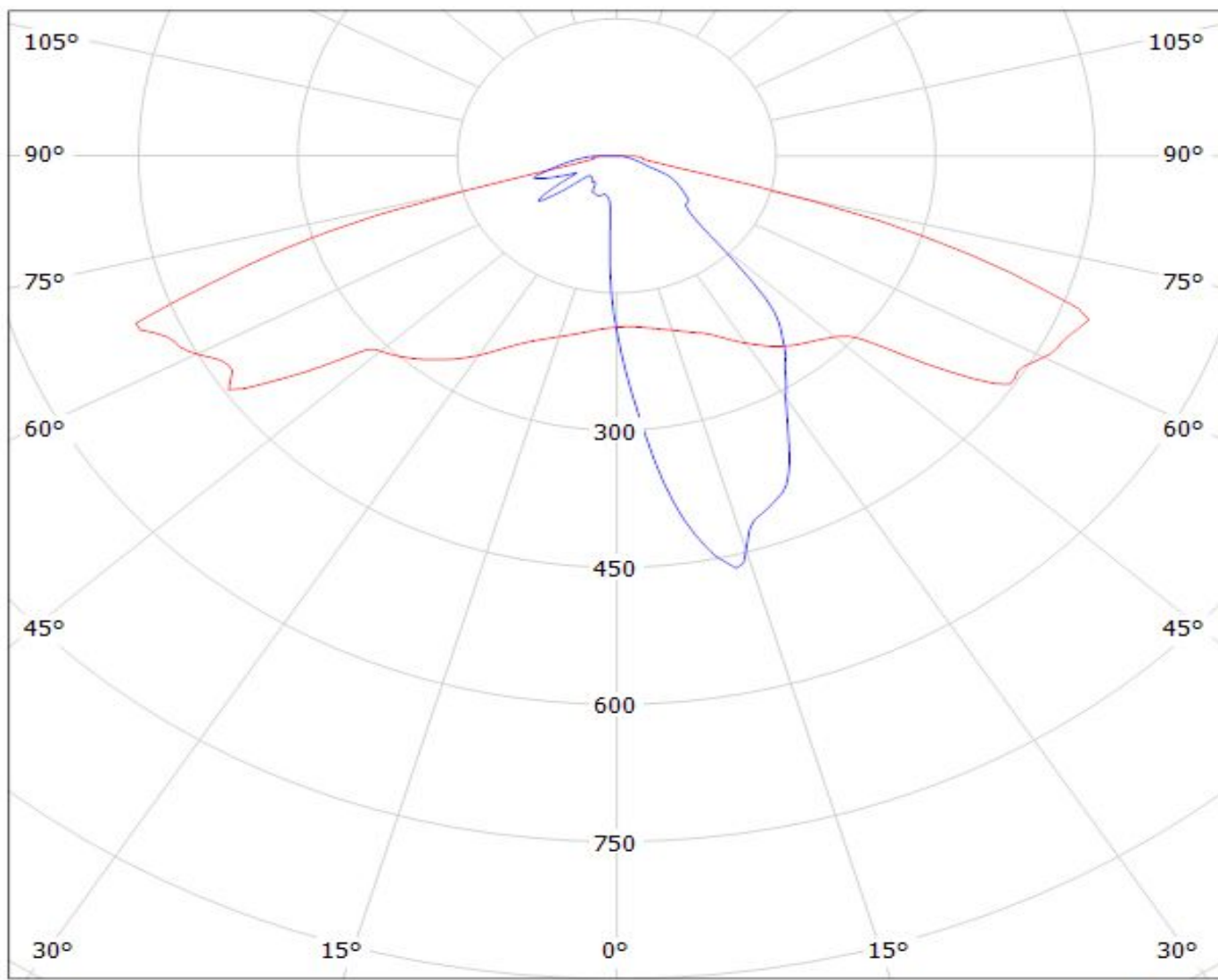

cd/klm

— C0 - C180 — C90 - C270

$\eta = 96\%$

LEDiL Oy C13300_STRADA-2X2-T2_(REBEL_ES) Eff.94.5% / LDC (Polar)

Luminaire: LEDiL Oy C13300_STRADA-2X2-T2_(REBEL_ES) Eff.94.5%

Lamps: 1 x XM-L (338lm@250mA)

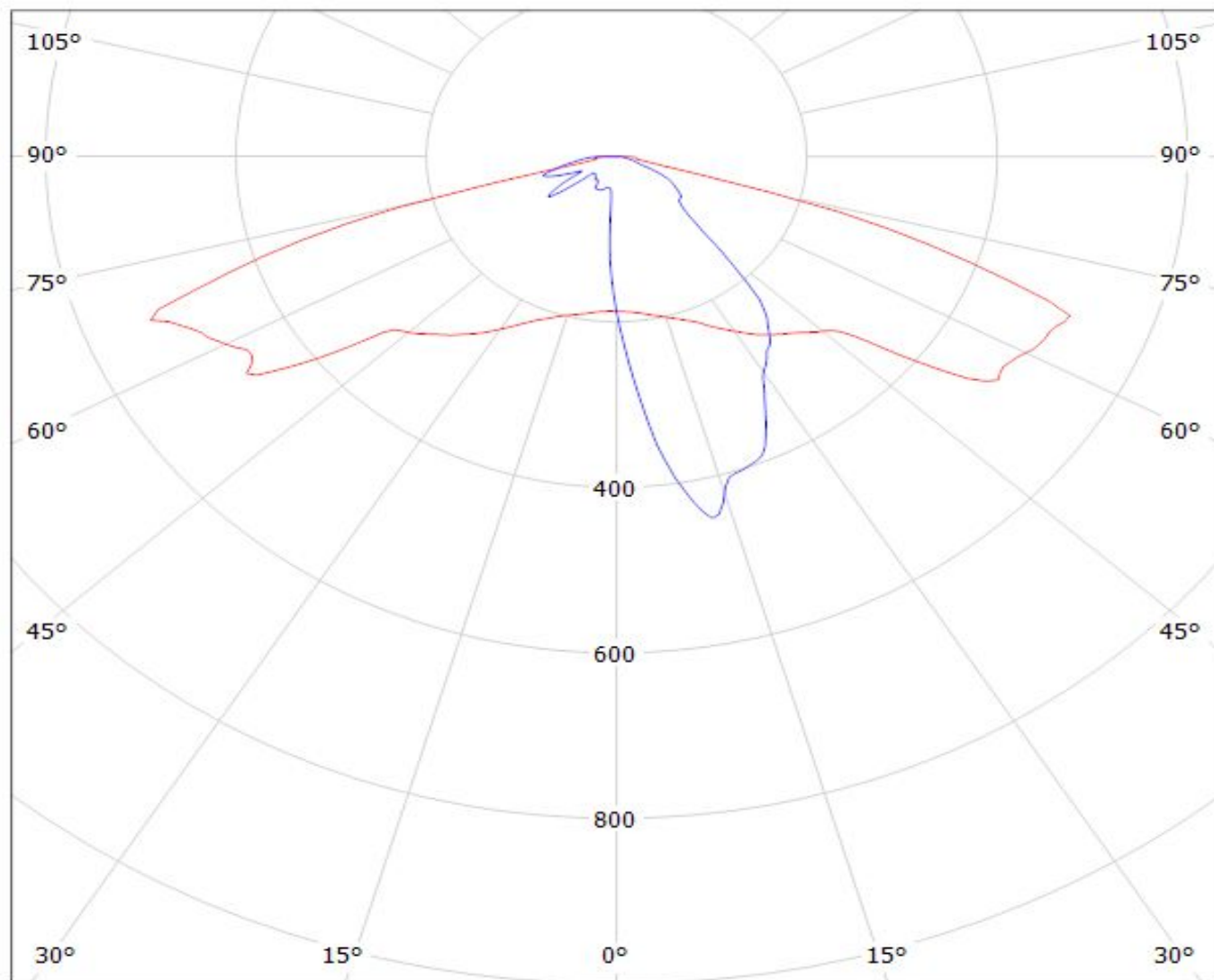

cd/klm

— C0 - C180

— C90 - C270

$\eta = 95\%$

Luminaire: LEDiL Oy C13300_STRADA-2X2-T2 Eff.94.4%
Lamps: 1 x Osram Square PC (399lm@250mA)

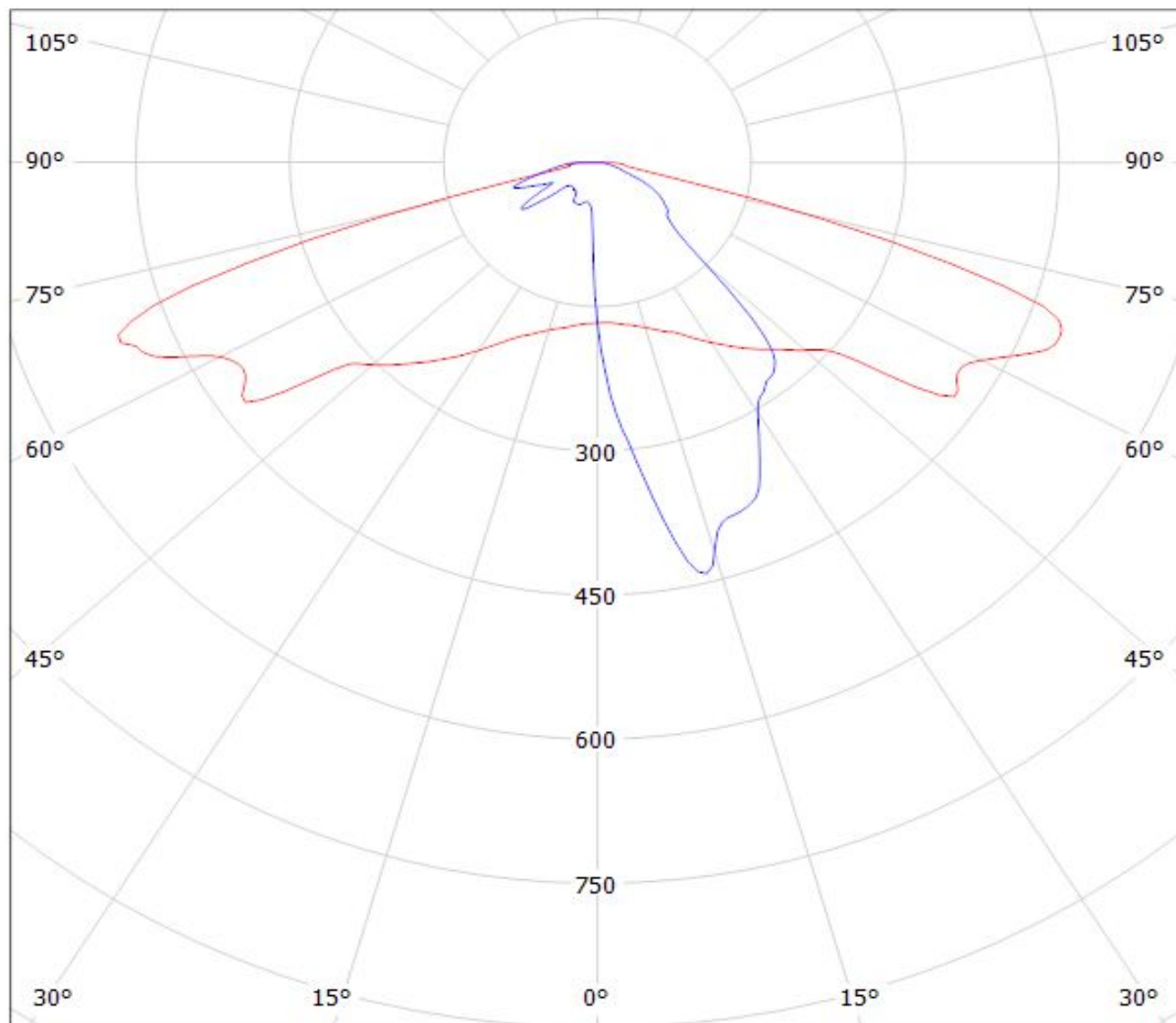

cd/klm

— C0 - C180

— C90 - C270

$\eta = 94\%$

LEDiL Oy C13300_STRADA-2X2-T2_(XM-L) Eff.95.1% / LDC (Polar)

Luminaire: LEDiL Oy C13300_STRADA-2X2-T2_(XM-L) Eff.95.1%

Lamps: 1 x XM-L (357lm@250mA)

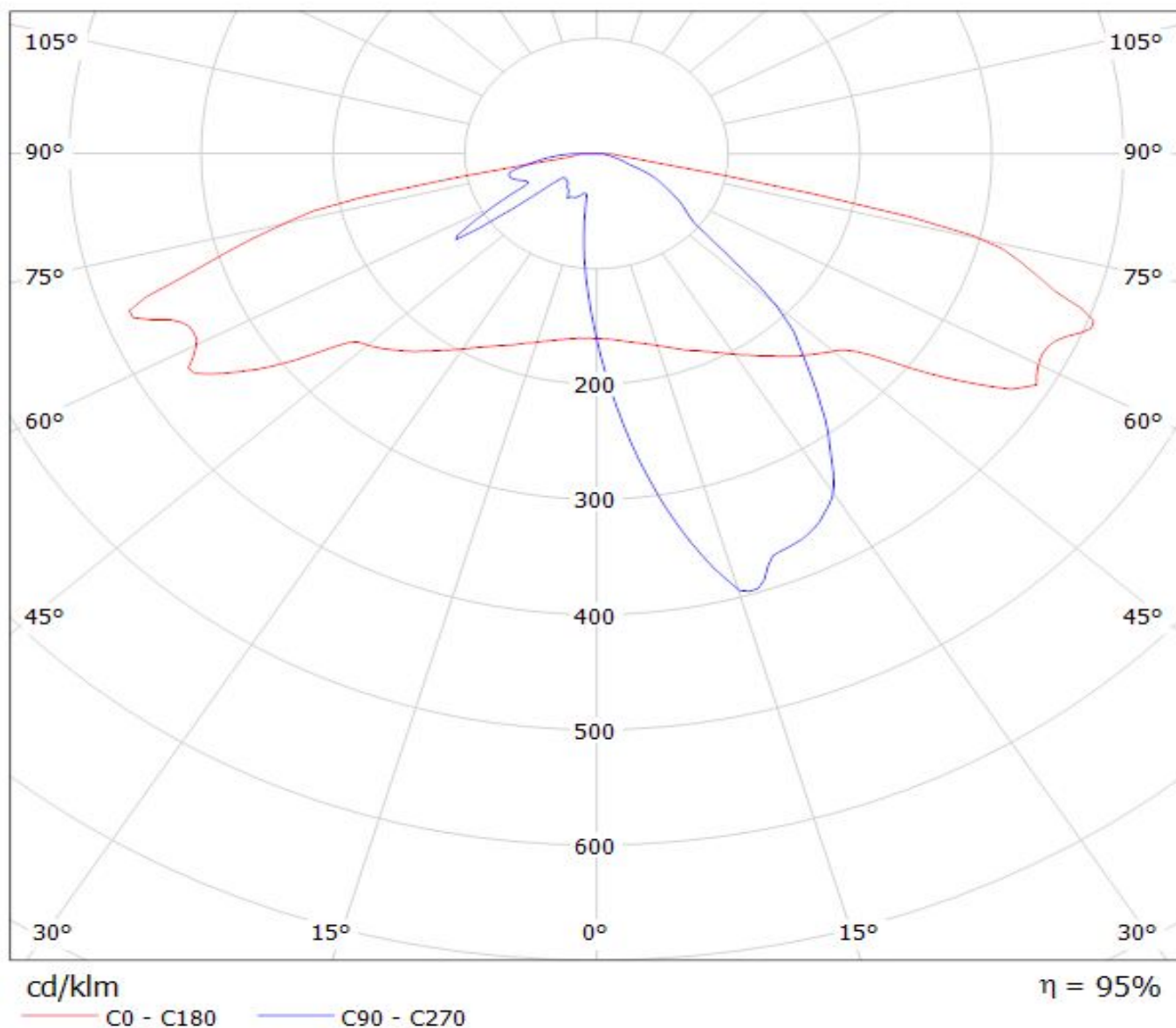

LEDiL Oy C13300_STRADA-2X2-T2_(XB-D) Eff.94.2% / LDC (Polar)

Luminaire: LEDiL Oy C13300_STRADA-2X2-T2_(XB-D) Eff.94.2%
Lamps: 1 x XM-L (370lm@250mA)

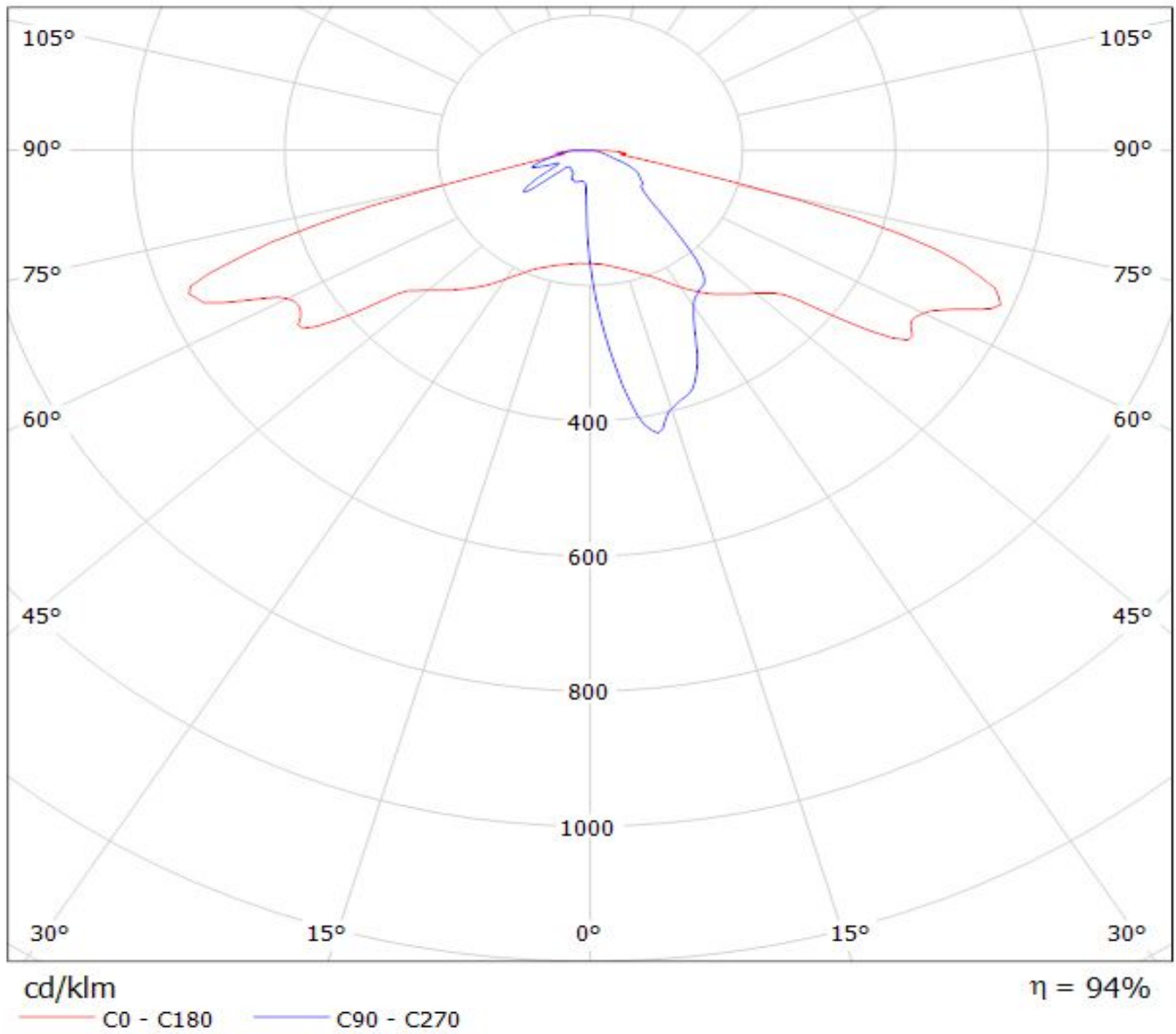

LEDiL Oy C13300_STRADA-2X2-T2_(XP-G2) Eff.90.9% / LDC (Polar)

Luminaire: LEDiL Oy C13300_STRADA-2X2-T2_(XP-G2) Eff.90.9%

Lamps: 1 x XP-G2 (433lm@250mA)

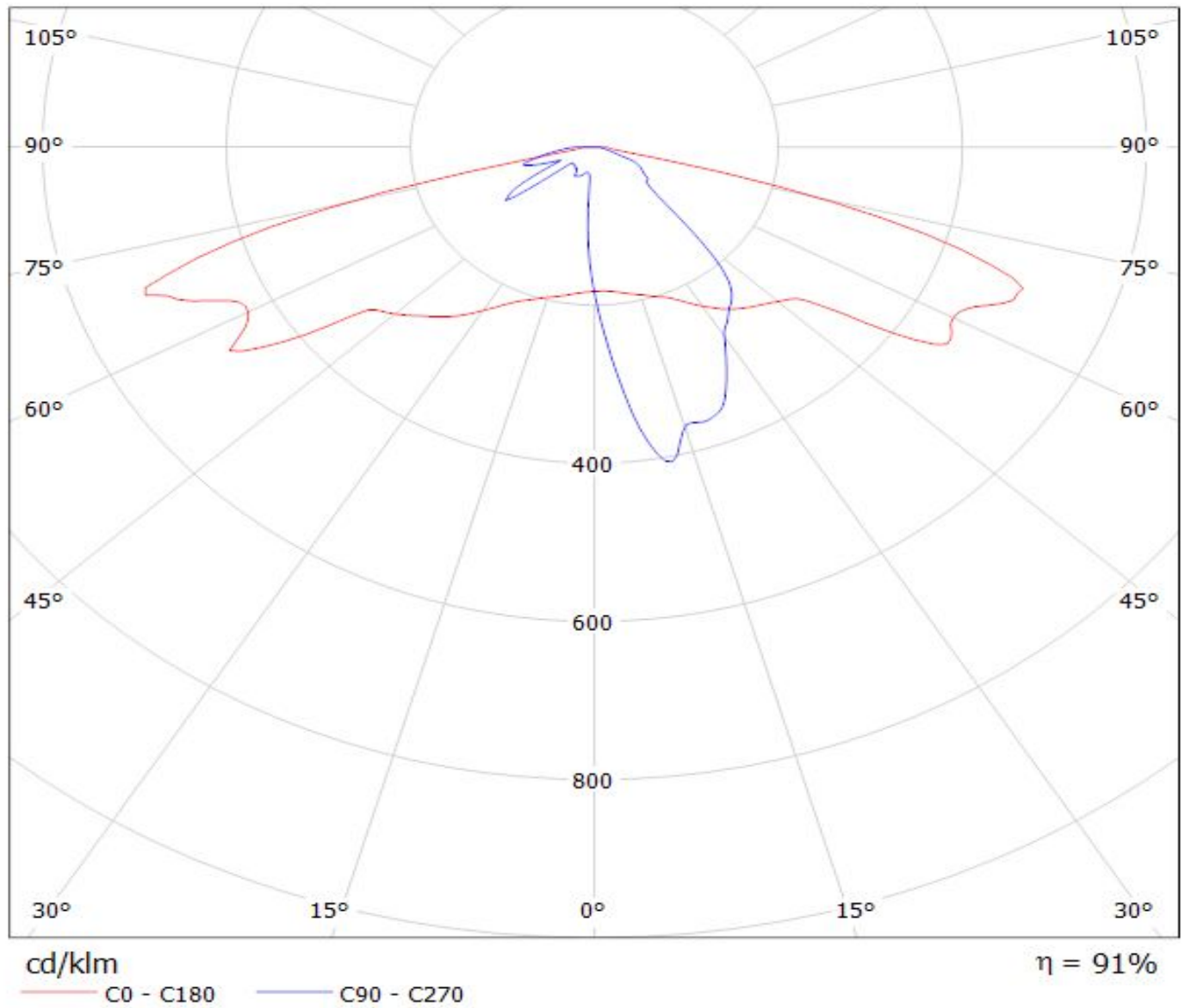

LEDiL Oy C13300_STRADA-2X2-T2_(XM-L2) Eff.94.5% / LDC (Polar)

Luminaire: LEDiL Oy C13300_STRADA-2X2-T2_(XM-L2) Eff.94.5%

Lamps: 1 x XM-L2 (366lm@250mA)

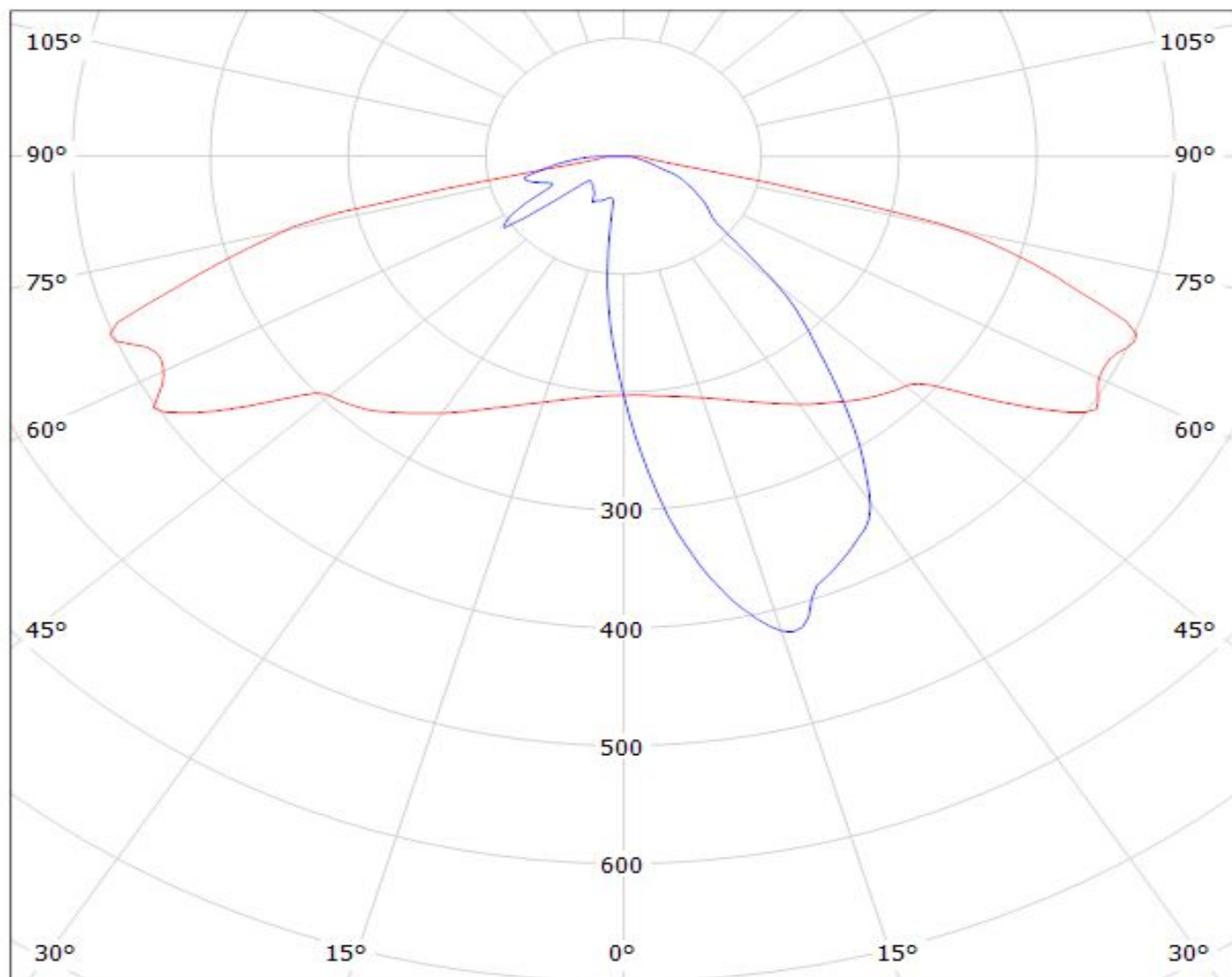

cd/klm

— C0 - C180

— C90 - C270

$\eta = 95\%$

Luminaire: LEDiL Oy C13300_STRADA-2x2-T2_(LUXEON_T) Eff.94.1%

Lamps: 1 x LUXEON_T 2x2 (294lm@250mA)

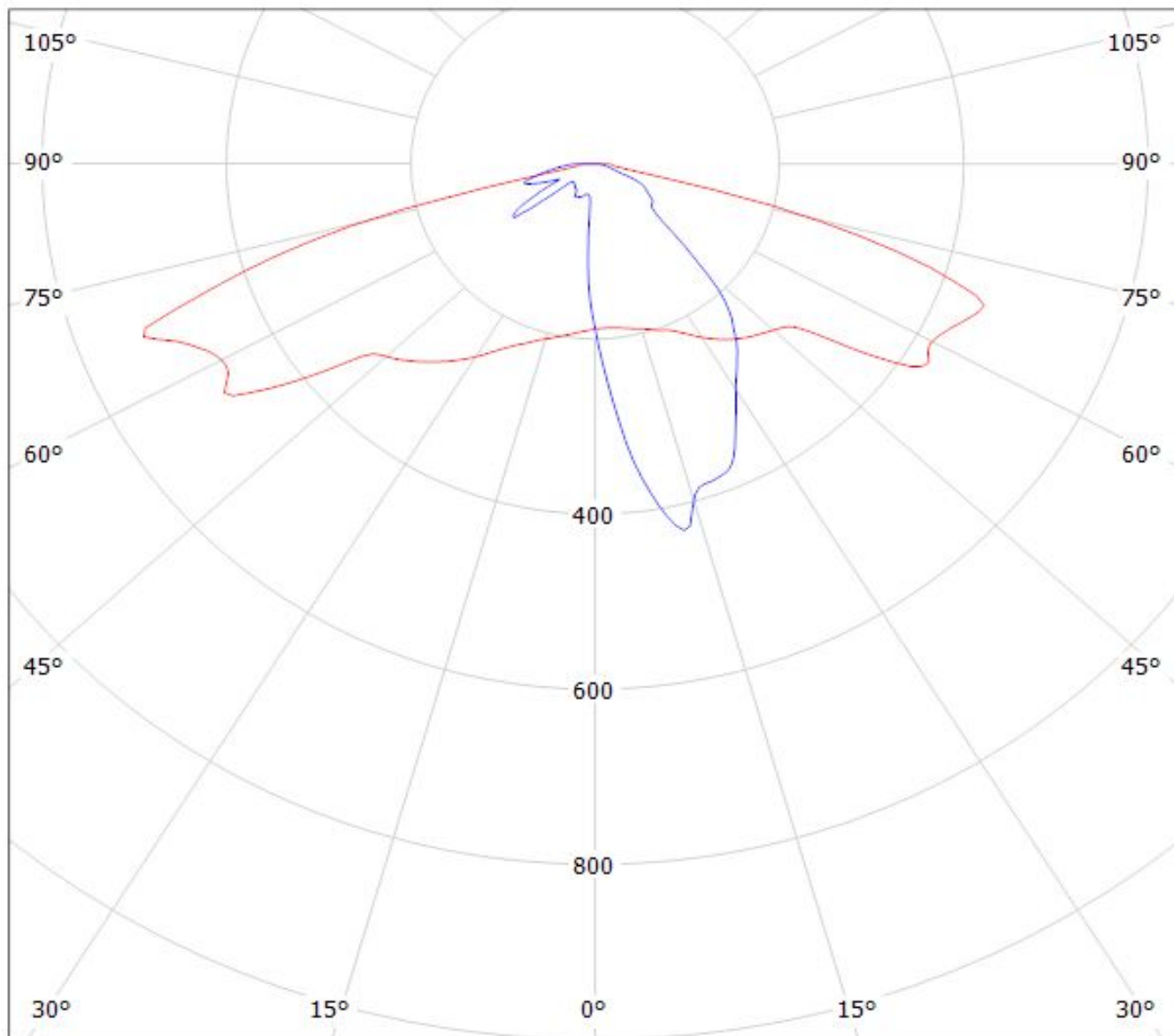

cd/klm

$\eta = 94\%$

— C0 - C180 — C90 - C270

LEDiL Oy C13300_STRADA-2X2-T2_(LG_3535) Eff.94.2% / LDC (Polar)

Luminaire: LEDiL Oy C13300_STRADA-2X2-T2_(LG_3535) Eff.94.2%

Lamps: 1 x LG_3535_Ceramic_2x2 (374lm@250mA)

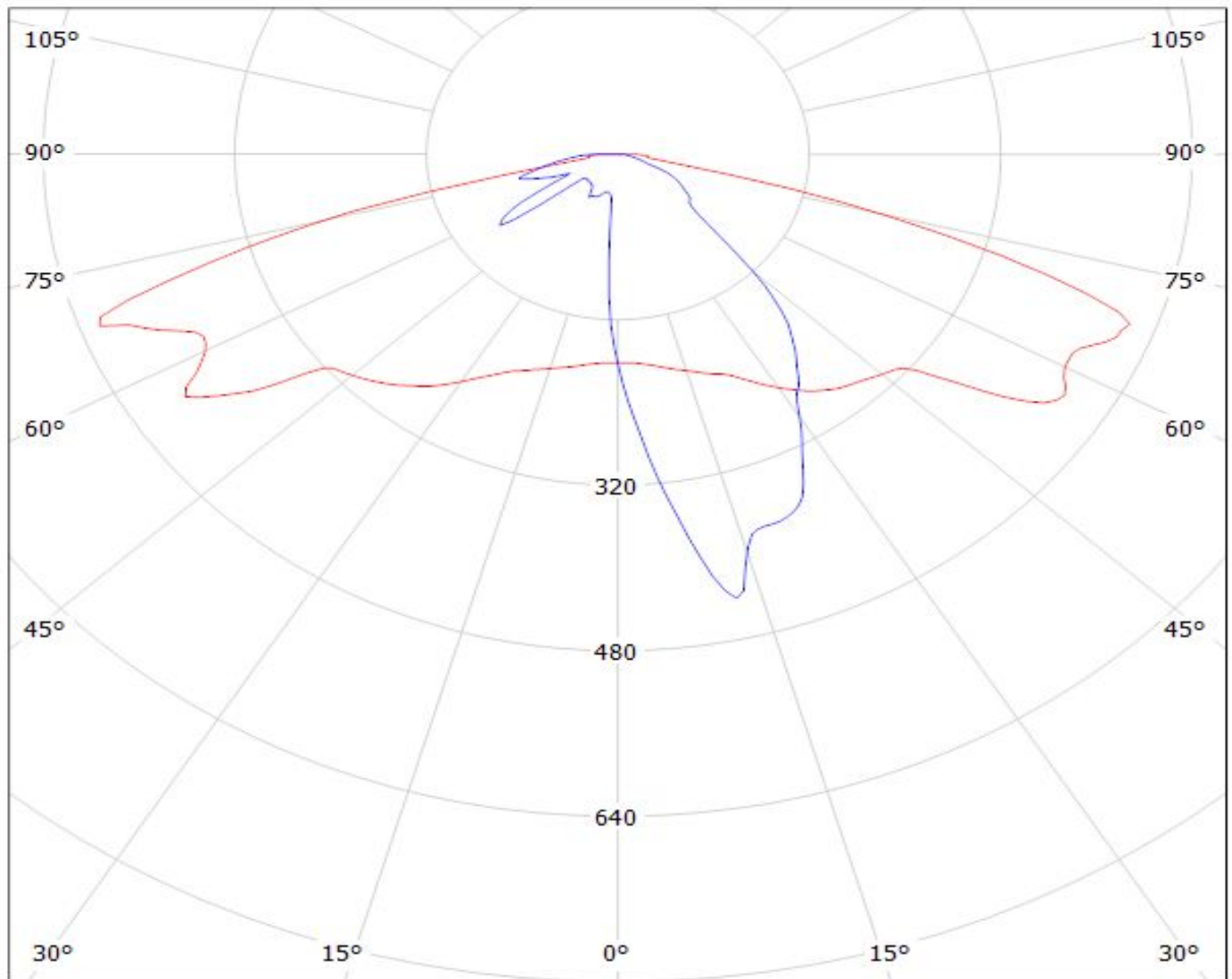

cd/klm

— C0 - C180

— C90 - C270

$\eta = 94\%$

**LEDiL Oy C13300_STRADA-2x2-T2_(NICHIA_NS9x383) Eff.95.4% / LDC
(Polar)**

Luminaire: LEDiL Oy C13300_STRADA-2x2-T2_(NICHIA_NS9x383) Eff.95.4%
Lamps: 1 x NICHIA_NS9x383 (287.074lm@250mA)

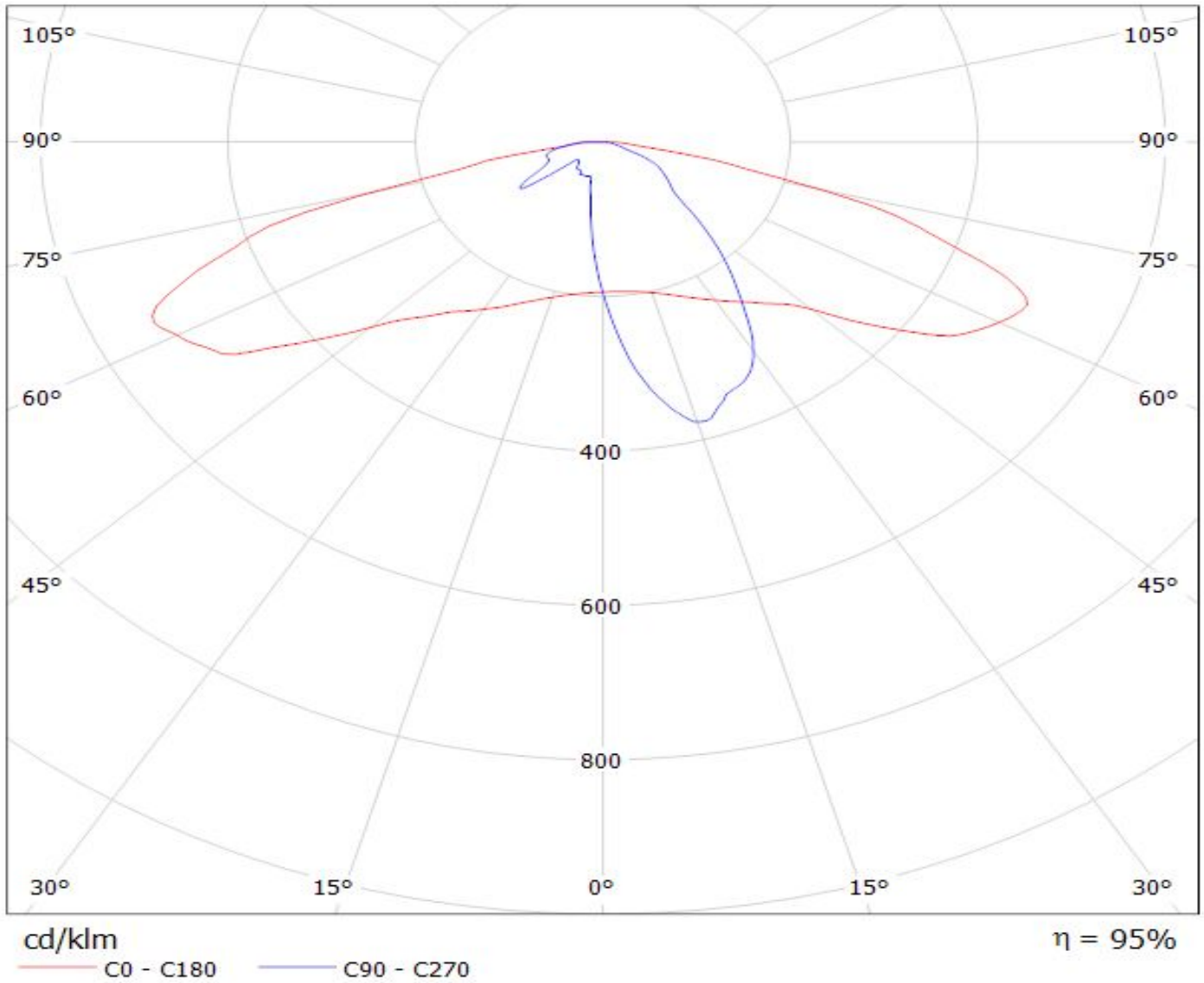

Luminaire: LEDiL Oy C13300_STRADA-2x2-T2_(MJT4040) Eff. 94%
Lamps: 1 x SEOUL ACRICH MJT4040 (SAW09H0A) 255lm@40mA P=2.37W I=40mA

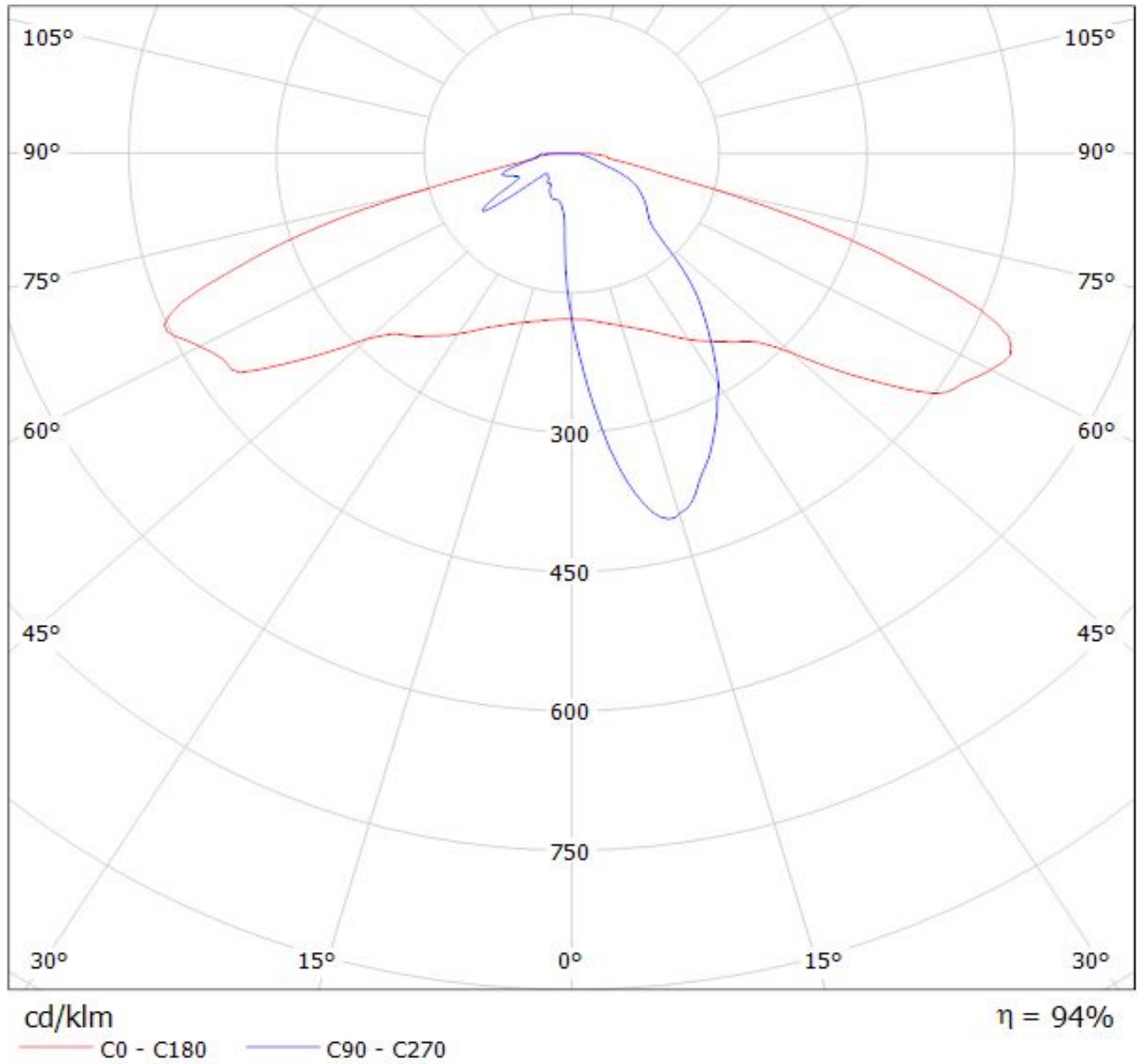

LEDiL Oy C13300_STRADA-2X2-T2_(LG-3535-CERAMIC-GEN2) Eff.94.0% / LDC (Polar)

Luminaire: LEDiL Oy C13300_STRADA-2X2-T2_(LG-3535-CERAMIC-GEN2) Eff.94.0%

Lamps: 1 x LG-3535-CERAMIC-GEN2_2x2_472.9lm@250mA_P=2.8651W_CCT=6562K_I=249.9mA

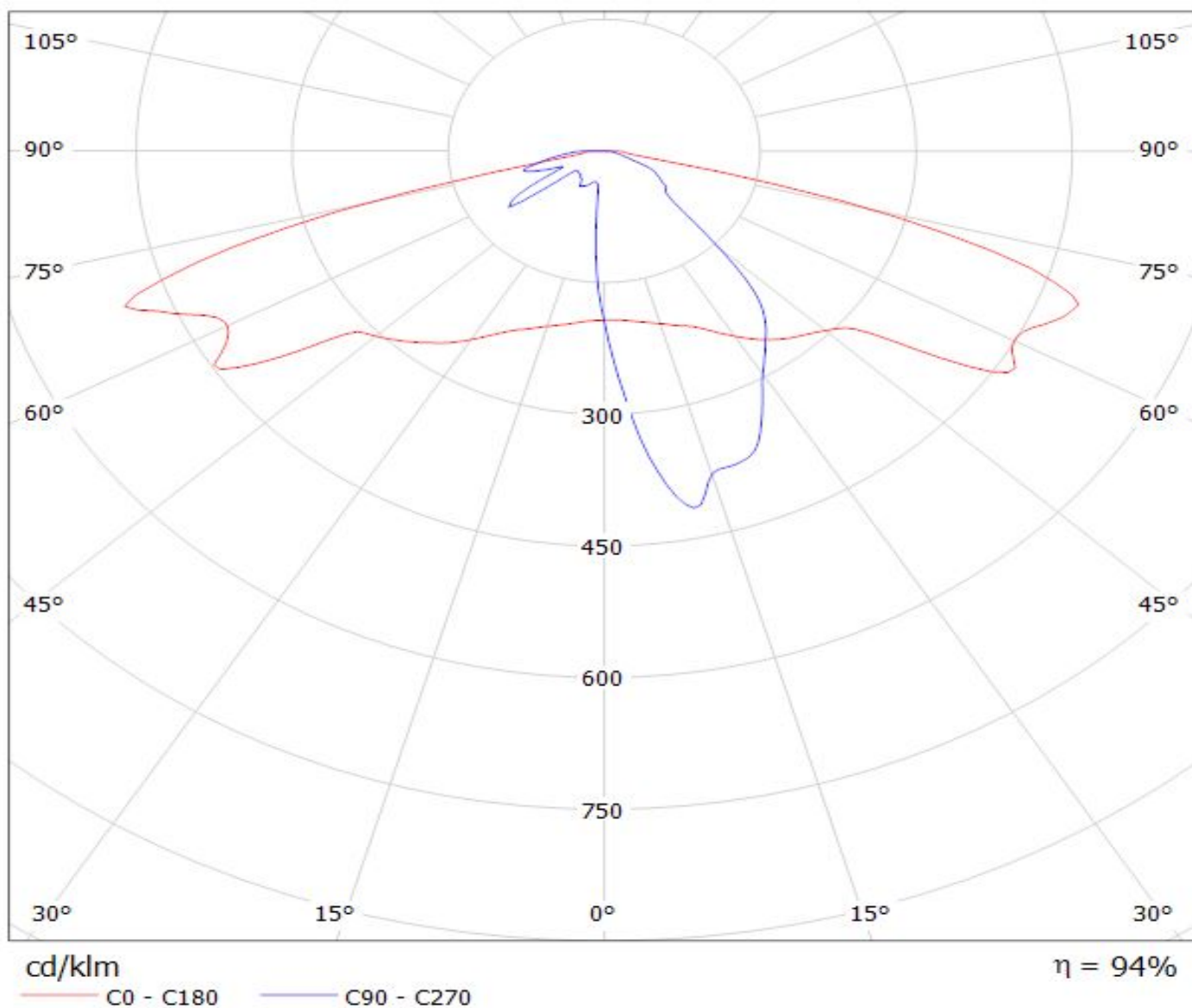

Luminaire: LEDiL Oy C13300_STRADA-2X2-T2_(Luxeon-Z-ES) Eff. 94%
Lamps: 1 x Luxeon Z ES 2x2 (LXZ2-3090) 209.277lm@250mA_P=2.81W_I=0.2499A

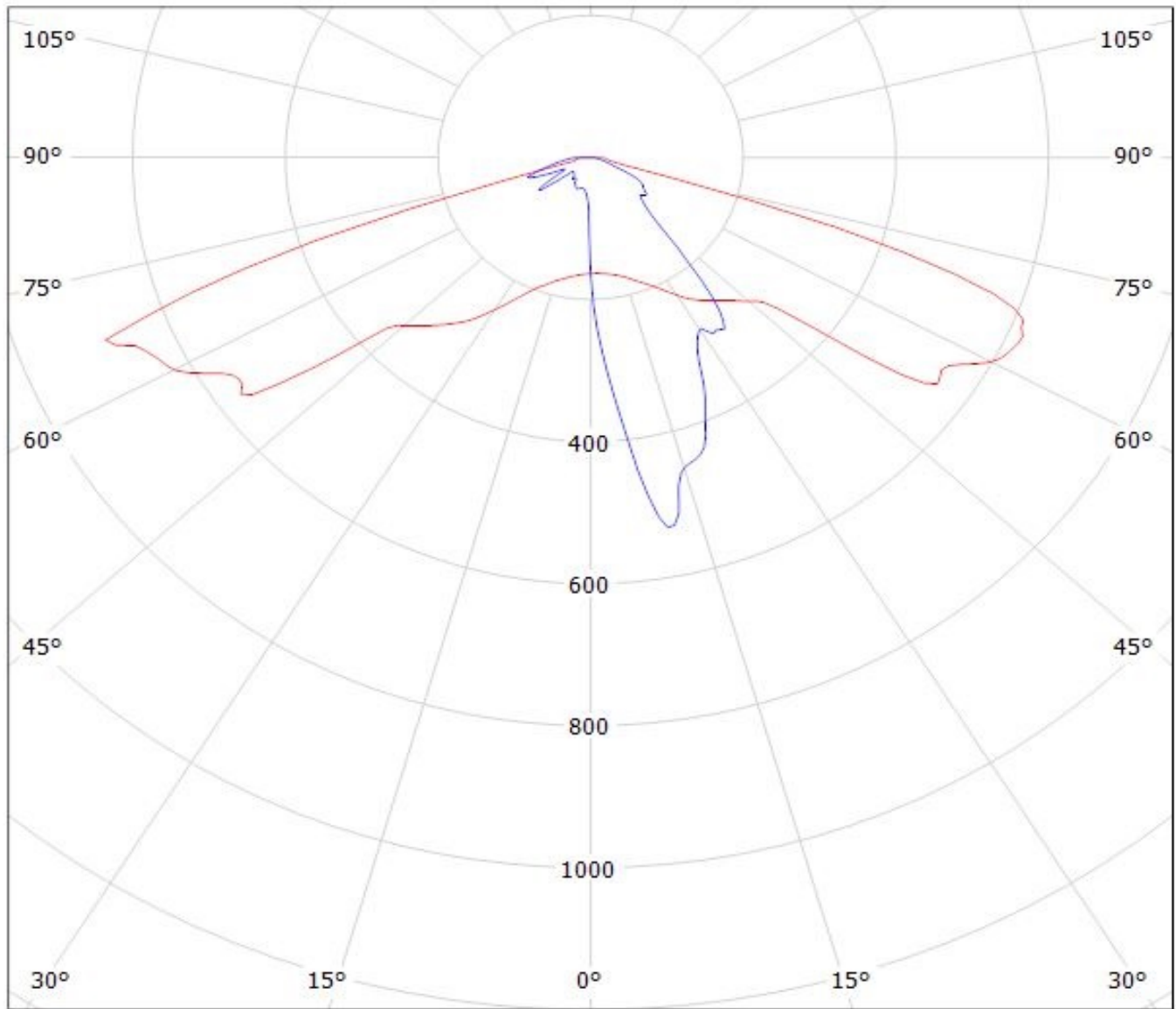

cd/klm
— C0 - C180 — C90 - C270

Luminaire: LEDiL Oy C13300_STRADA-2X2-T2_(LUXEON_Q)

Lamps: 1 x LUXEON_Q_2x2_(LHQ-3080)_298.363lm@250mA_P=2.87385W_I=249.9mA

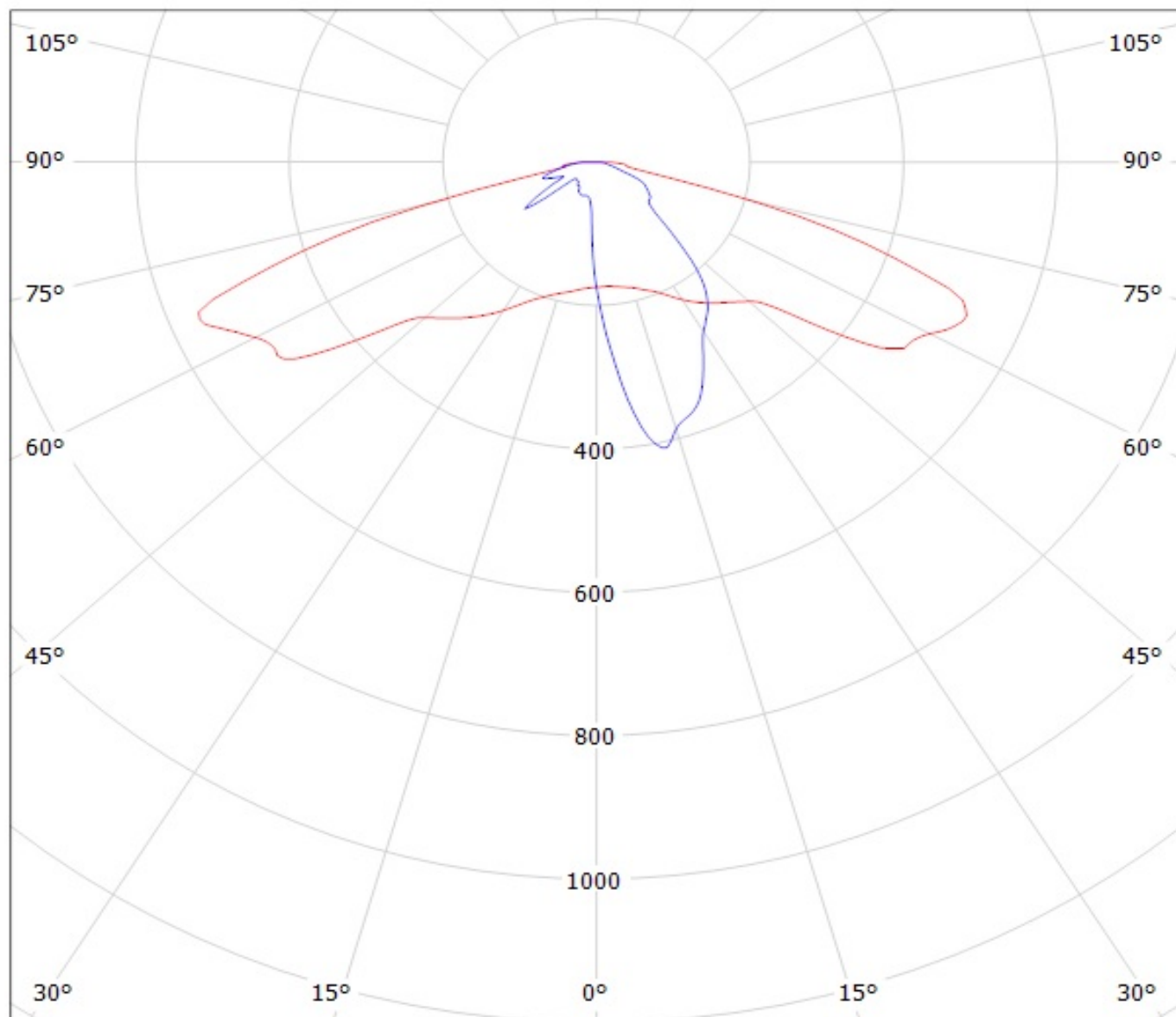

cd/klm

— C0 - C180

— C90 - C270

Luminaire: LEDil Oy C13300_STRADA-2X2-T2_(Z5M1) Efficiency=94%
Lamps: 1 x Seoul Z5M1 (SZ5-M1-WN-C8) 379lm @ 250mA CCT=4600K P=2.9W I=250mA

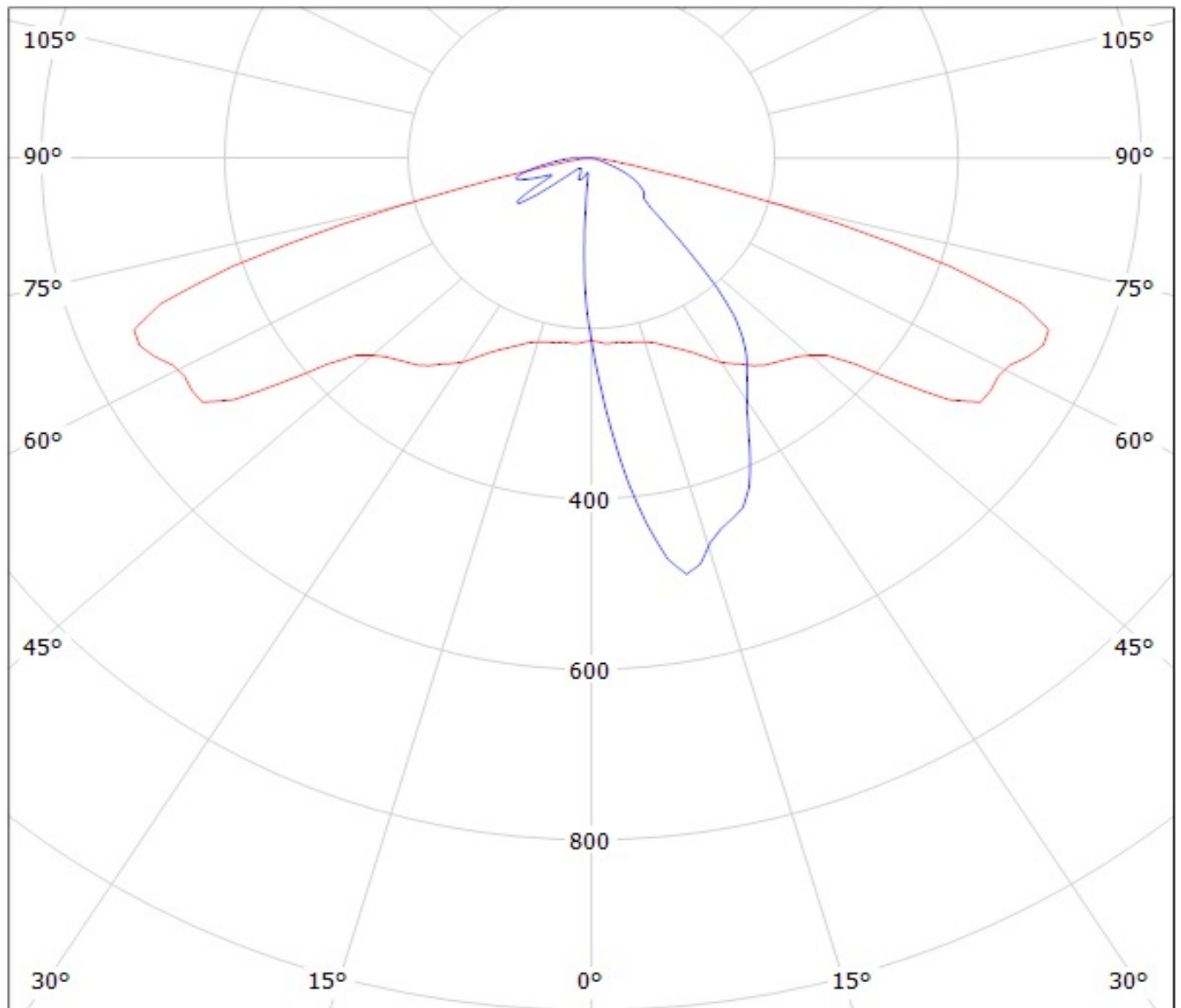

cd/klm
— C0 - C180 — C90 - C270

Luminaire: LEDiL Oy C13300_STRADA-2x2-T2_(XP-L)

Lamps: 1 x CREE_XP-L_2x2_(XPLAWT-0-1B0-V40-00-0001)_508.75lm@250mA_CCT=7600K_P=2.79963W_I=249.9mA

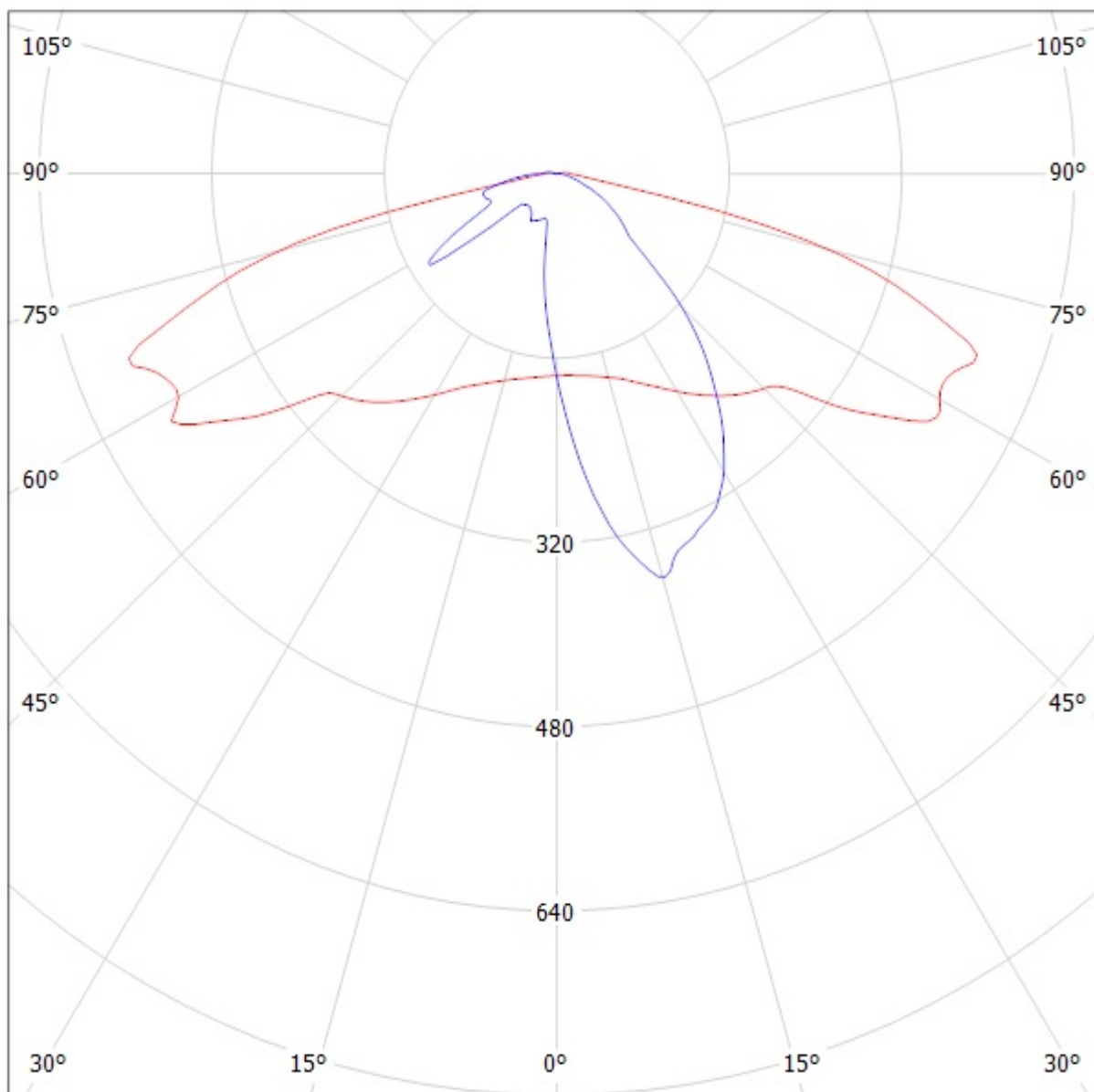

cd/klm

— C0 - C180 — C90 - C270

$\eta = 94\%$

Luminaire: LEDiL Oy C13300_STRADA-2X2-T2_(LUXEON_MZ) Eff.94.0%

Lamps: 1 x LUXEON_MZ_2x2_(LMZ7-QW57)_417.25lm@250mA_P=2.71916W_CCT=5700K_I=249.9mA

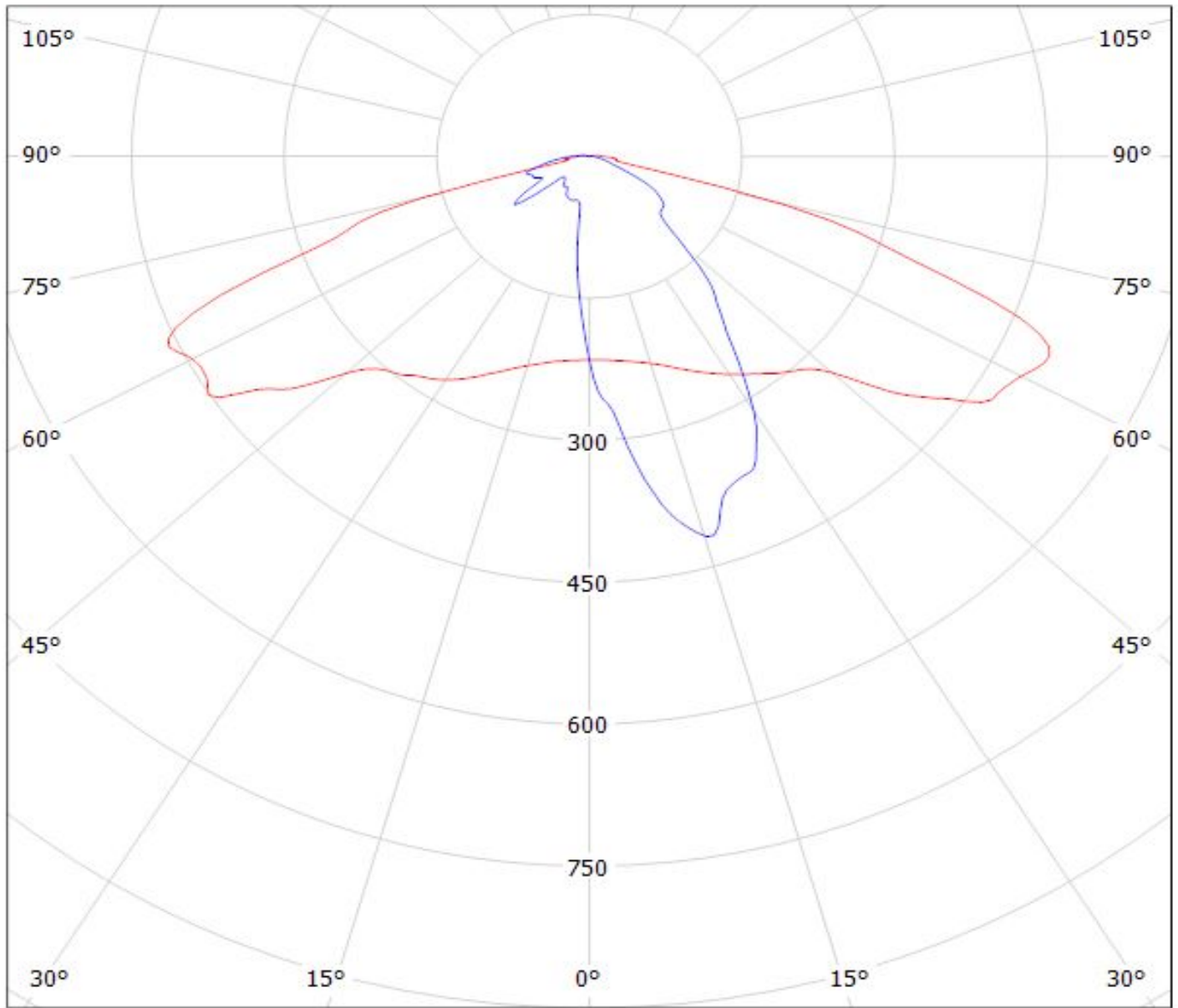

cd/klm

— C0 - C180

— C90 - C270

$\eta = 94\%$

Luminaire: LEDiL Oy C13300_STRADA-2X2-T2_(Luxeon_TX)

Lamps: 1 x Luxeon_TX_2x2_321.384lm@250mA_P=2.79488W_I=249.9mA

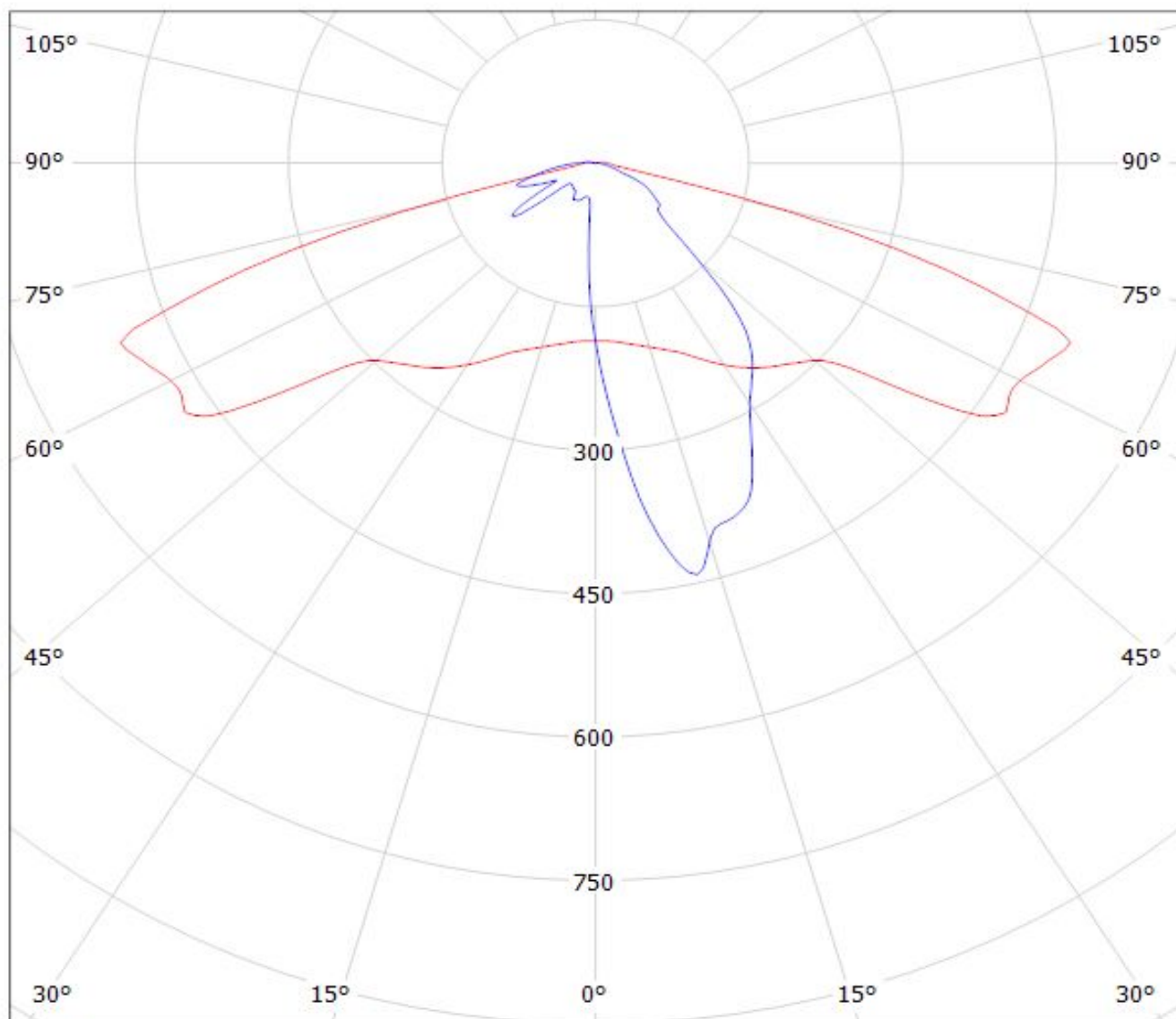

cd/klm

$\eta = 95\%$

— C0 - C180 — C90 - C270

Luminaire: LEDiL Oy C13300_STRADA-2X2-T2_(LH351B)

Lamps: 1 x SAMSUNG_LH351B_2x2_440.73lm@250mA_P=2.84311W_I=249.9mA

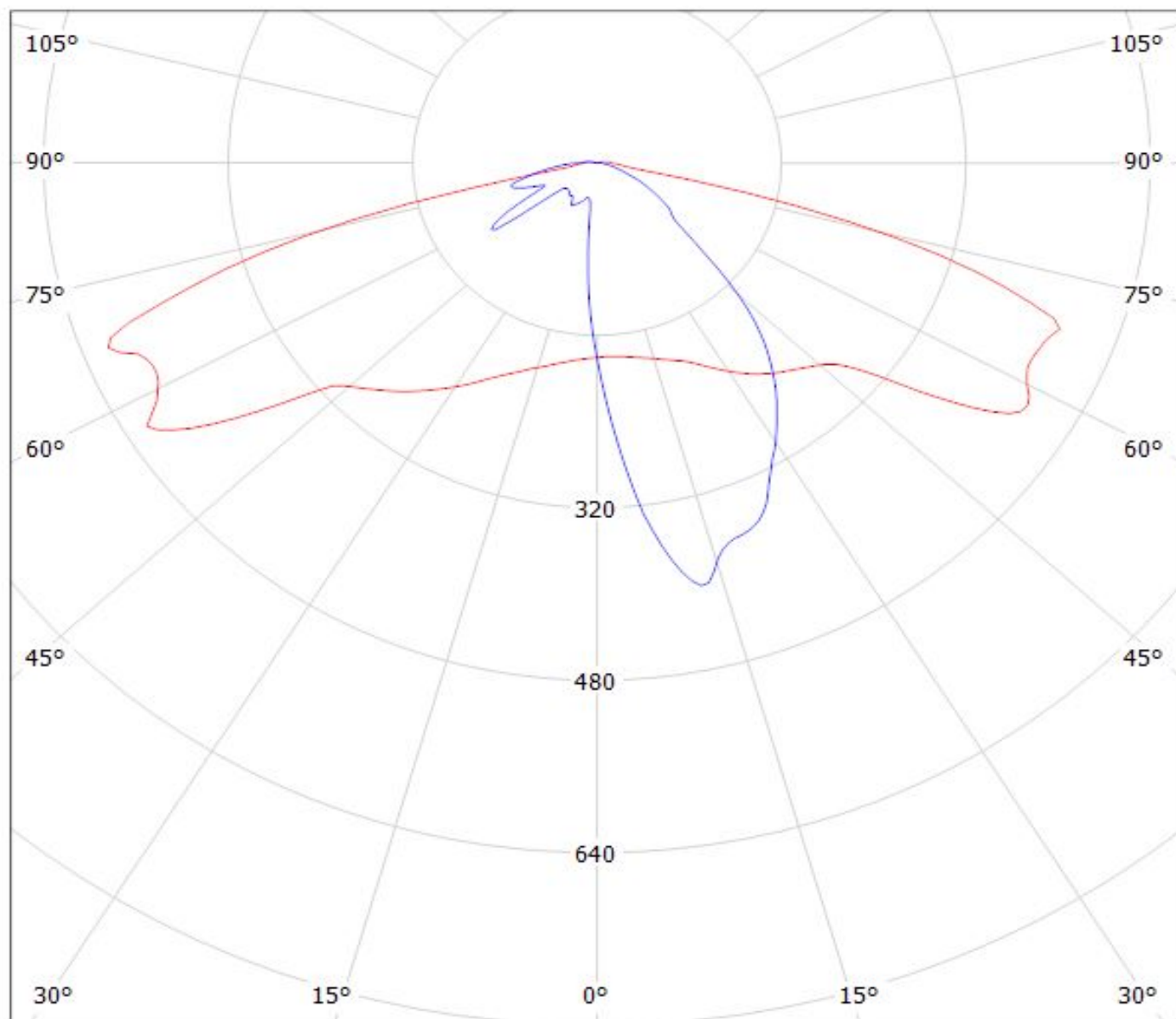

cd/klm

— C0 - C180

— C90 - C270

$\eta = 94\%$

Luminaire: LEDiL Oy C13300_STRADA-2X2-T2_(LH351Z)

Lamps: 1 x SAMSUNG_LH351Z_2x2_365.89lm@250mA_P=2.86371W_I=249.8mA

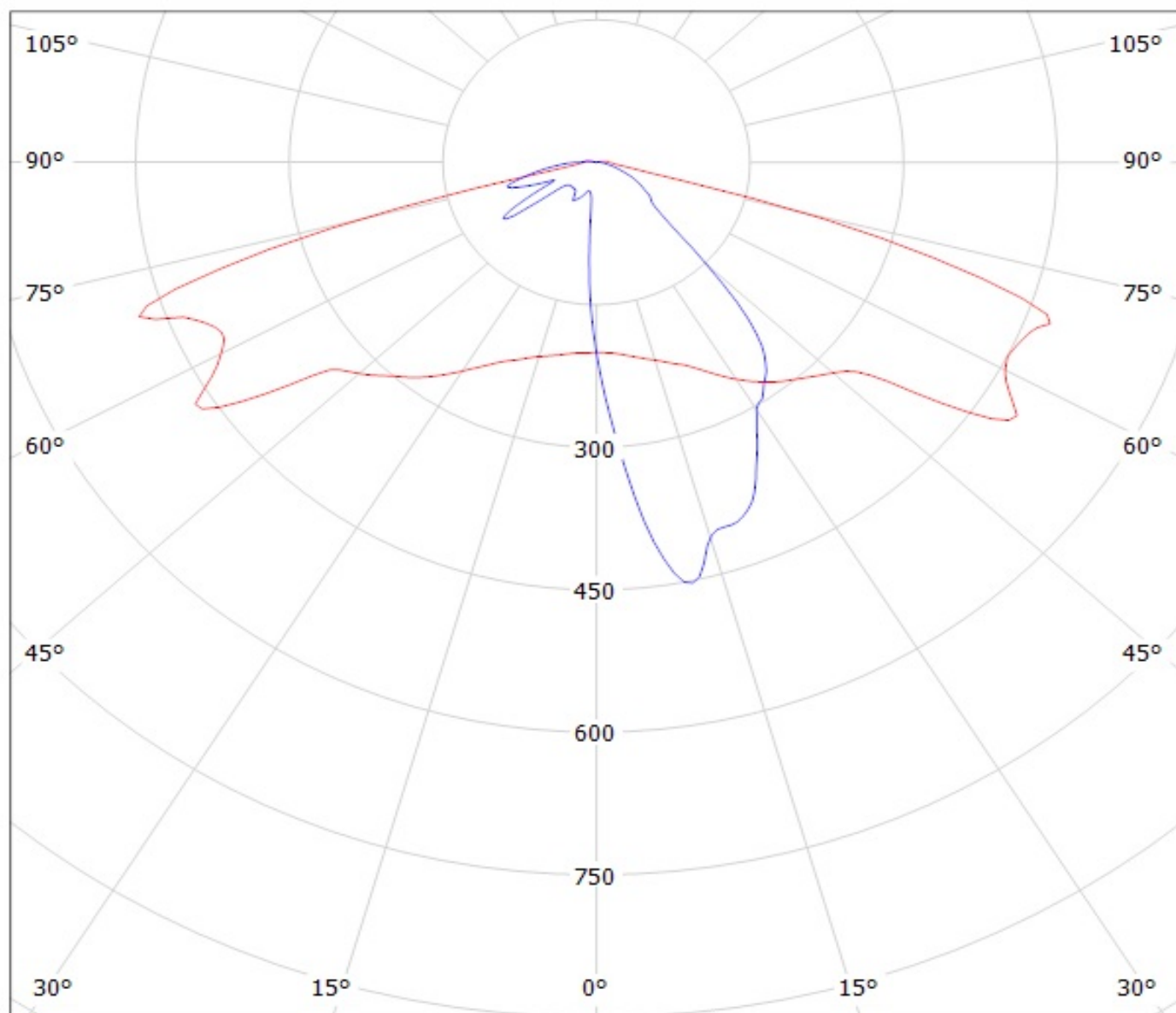

cd/klm

— C0 - C180

— C90 - C270

$\eta = 94\%$

Ledil C13300_STRADA-2X2-T2_(TL1L3) / LDC (Polar)

Luminaire: Ledil C13300_STRADA-2X2-T2_(TL1L3)

Lamps: 1 x Toshiba_TL1L3_2x2_(TL1L3-NW1.L)_387.773lm@250mA_CCT=5000K_P=2.829W_I=0.25A

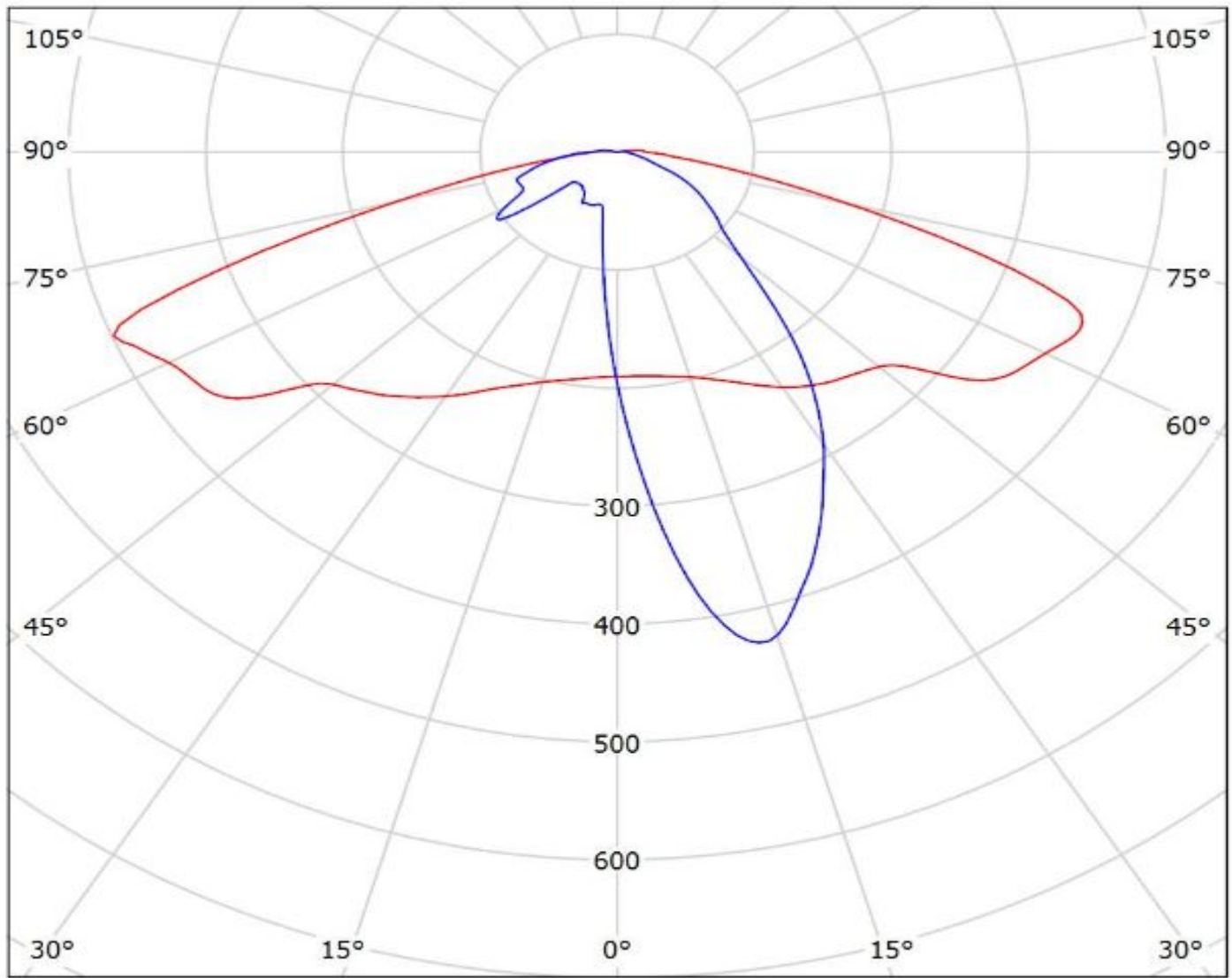

cd/klm

— C0 - C180 — C90 - C270

$\eta = 95\%$

Luminaire: LEDiL Oy C13300_STRADA-2X2-T2_(Fortimo_F-Flex_2x8_740DAG3)

Lamps: 1 x Philips_Fortimo_F-Flex_2x8_740DAG3_1786.86lm@250mA_P=11.6092W_I=0.2498A

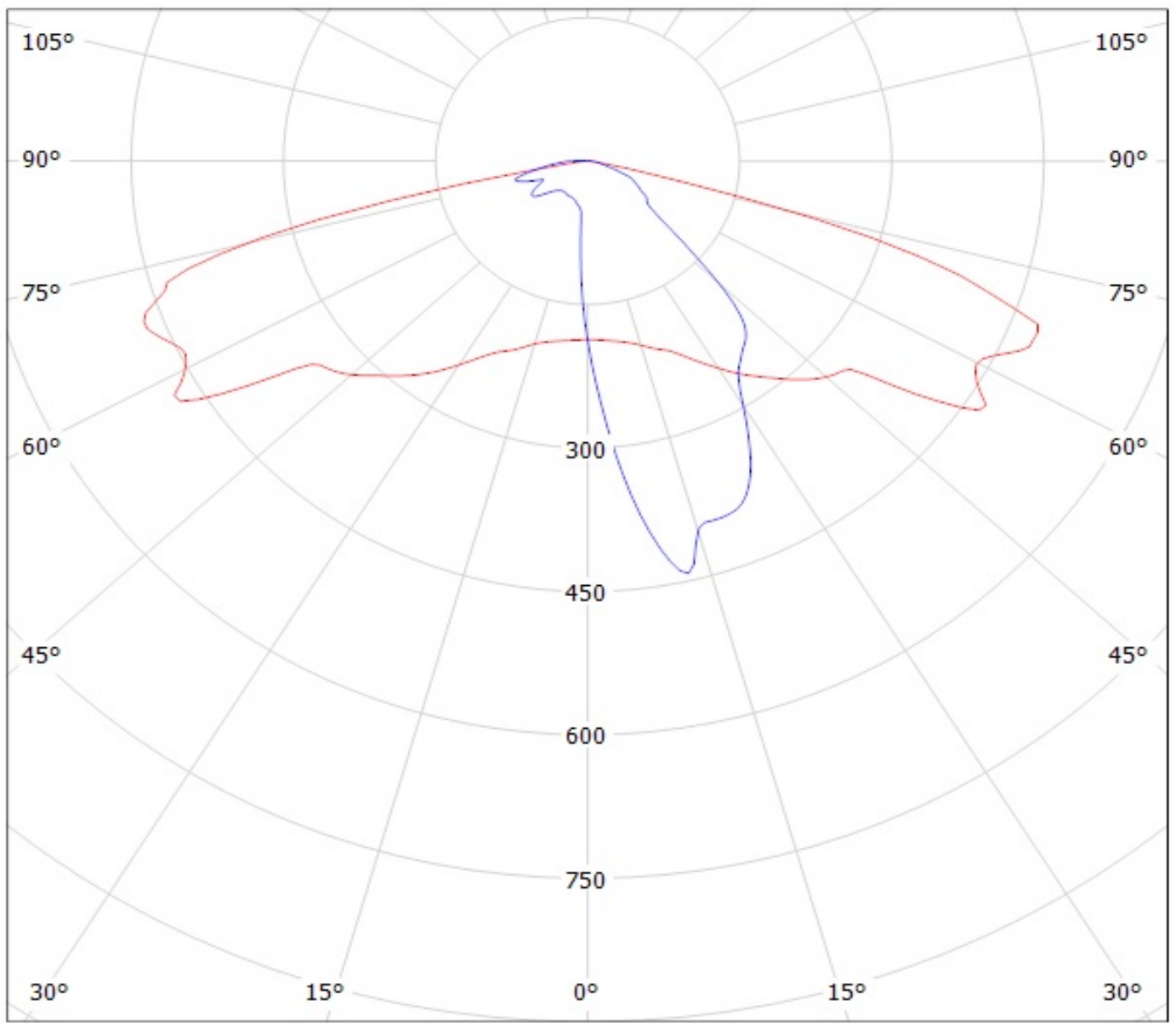

cd/klm

— C0 - C180

— C90 - C270

$\eta = 95\%$

Ledil C13300_STRADA-2X2-T2_(TL1L4) / LDC (Polar)

Luminaire: Ledil C13300_STRADA-2X2-T2_(TL1L4)

Lamps: 1 x Toshiba_TL1L4_2x2_(TL1L4-DW0)_472.639lm@250mA_CCT=6500K_P=2.9W_l=0.25A

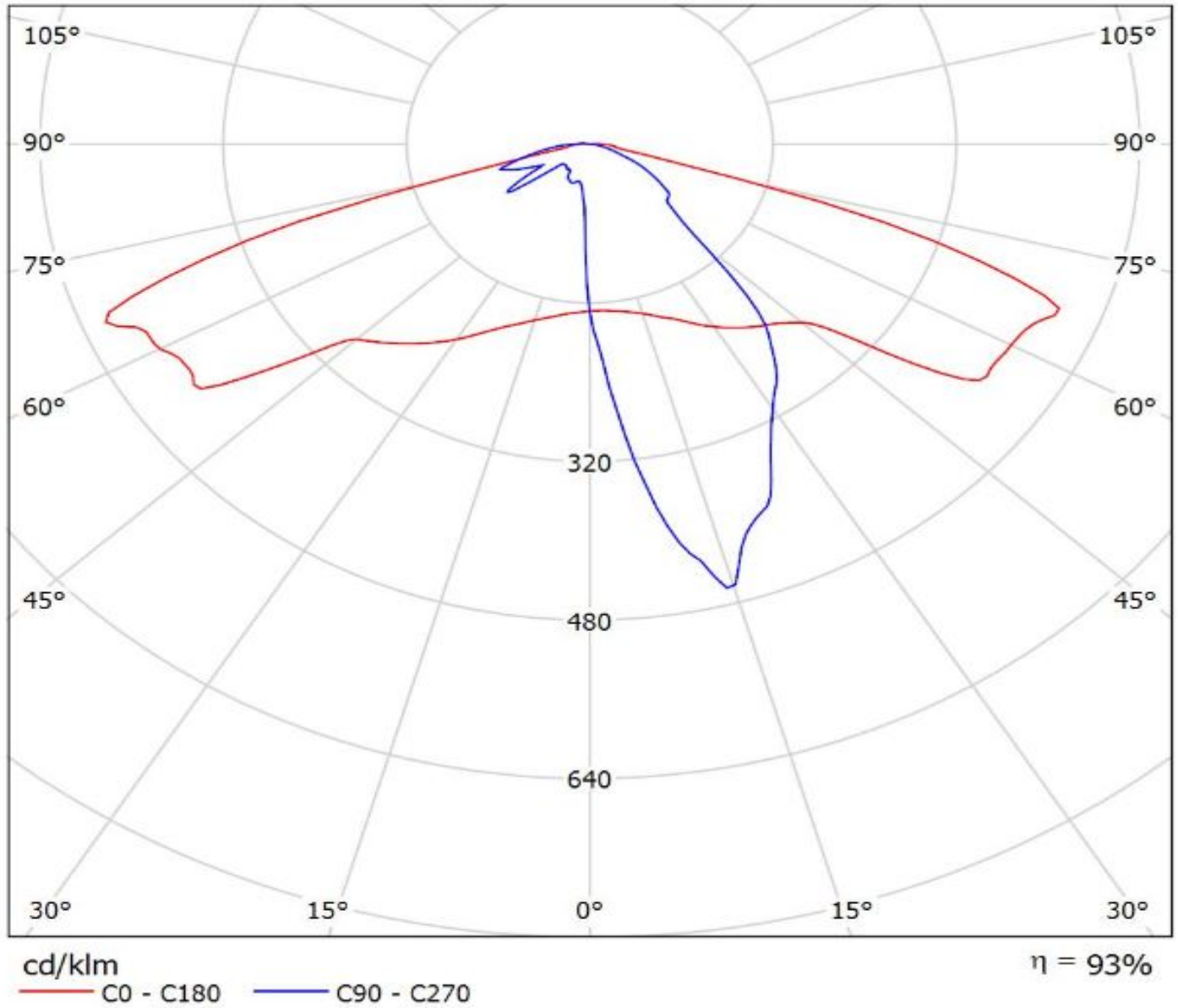

Luminaire: LEDiL Oy C13300_STRADA-2X2-T2_(XP-L_HI)
Lamps: 1 x Cree_XP-L_HI_(2x2)_(XPLAWT-H-5A3-U60-013-0001)
_455.077lm@250mA_P=2.84011W_I=0,2499A

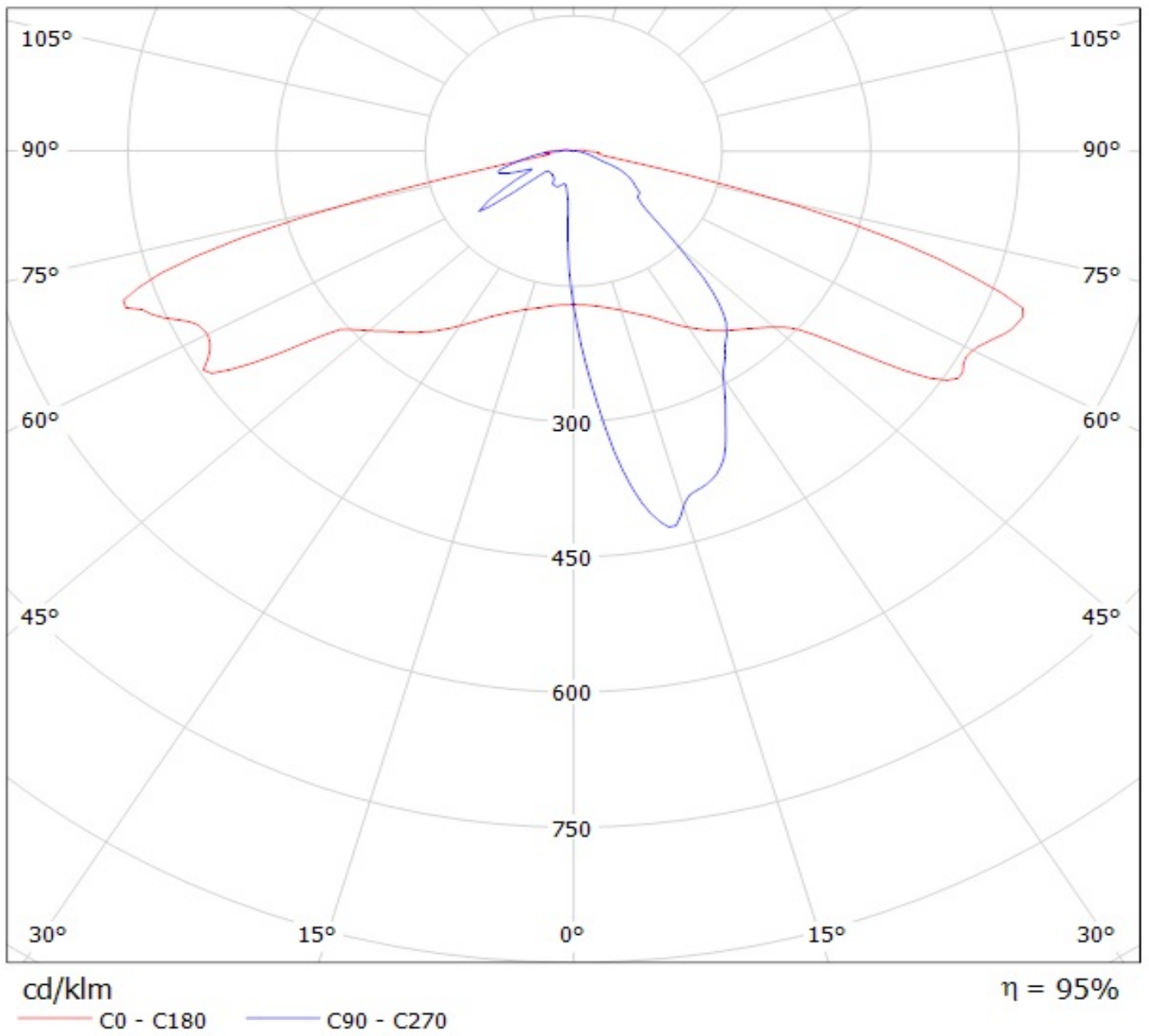

NOTE: The typical divergence will be changed by different color, chip size and chip position tolerance. The typical total divergence is the full angle measured where the luminous intensity is half of the peak value.