

## DETAILS

|                        |                  |
|------------------------|------------------|
| <b>Product Number</b>  | C13233_HB-2X2-M  |
| <b>Family</b>          | High Bay         |
| <b>Type</b>            | Lens array       |
| <b>Color</b>           | clear            |
| <b>Diameter</b>        | 50x50 mm         |
| <b>Height</b>          | 8,5 mm           |
| <b>Style</b>           | square           |
| <b>Optic Material</b>  | PMMA             |
| <b>Holder Material</b> |                  |
| <b>Fastening</b>       | screw, pin, glue |
| <b>Status</b>          | ready            |
| <b>ROHS Compliant</b>  | Yes              |
| <b>Date Updated</b>    | 6/07/2015        |



## OPTICAL PROPERTIES

| LED               | Viewing | Light  | Effi-     |            | Connector |
|-------------------|---------|--------|-----------|------------|-----------|
|                   | Angle   | Beam   | ciency    | cd/lm      |           |
| XQ-E HI           | sim: 22 | Medium | sim: 93 % | sim: 5.500 | -         |
| Z8Y15             | 20 deg  | Medium | 89 %      | 4.600      | -         |
| LUXEON Z ES       | 21 deg  | Medium | 91 %      | 5.640      | -         |
| Z8Y19             | 22 deg  | Medium | 89 %      | 3.800      | -         |
| XT-E              | 25 deg  | Medium | 92 %      | 3.700      | -         |
| TL1L4             | 25 deg  | Medium | 85 %      | 3.500      | -         |
| XB-D              | 26 deg  | Medium | 95 %      | 3.900      | -         |
| LUXEON Q          | 26 deg  | Medium | 94 %      | 3.600      | -         |
| NVSxx19B/NVSxx19C | 29 deg  | Medium | 91 %      | 3.100      | -         |
| H35C1 (LEMWA33)   | 29 deg  | Medium | 91 %      | 3.400      | -         |
| Oslon Square PC   | 30 deg  | Medium | 91 %      | 3.400      | -         |
| Z5M1/Z5M2         | 30 deg  | Medium | 90 %      | 3.400      | -         |
| XP-G              | 31 deg  | Medium | 91 %      | 3.100      | -         |
| LH351B            | 31 deg  | Medium | 94 %      | 2.800      | -         |
| LH351Z            | 32 deg  | Medium | 93 %      | 2.900      | -         |
| XP-G2             | 33 deg  | Medium | 93 %      | 3.400      | -         |

D

C

B

A

4

4

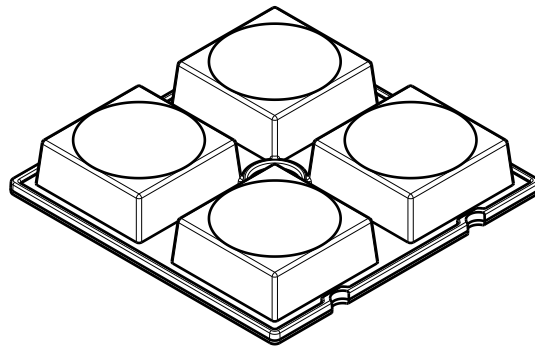
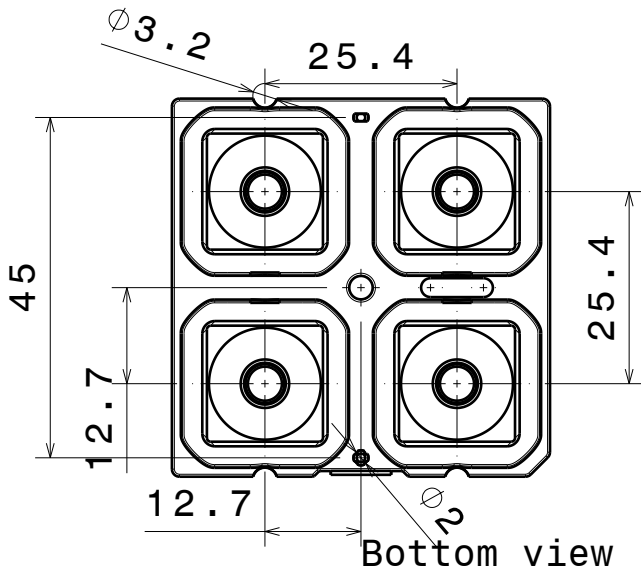

3

3

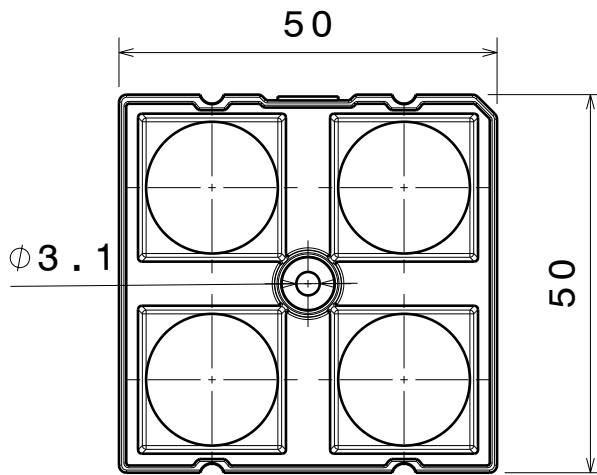
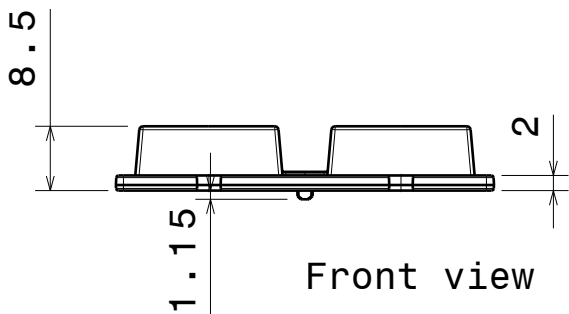

2

2

| INDEX | PART NO | DESCRIPTION | MATERIAL | COLOUR |
|-------|---------|-------------|----------|--------|
| 1     | C13233  | HB-2X2-M    | PMMA     |        |

Tolerances if not otherwise shown  
 According to DIN ISO 2768-1  
 Linear measures:  
 Up to 30mm class M, otherwise class C.  
 According to DIN ISO 2768-2  
 Form and position: class L

**LEDiL**  
 Ledil Oy  
 Salorankatu 10  
 FIN 24240 SALO  
 Finland

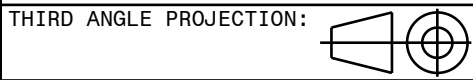

DRAWING TITLE  
**HB-2X2-M**

This drawing is the property of LEDiL Oy. It may not be reproduced, copied or communicated without a written agreement with LEDiL Oy."

SIZE  
**A4**  
**C13233**

SCALE 1:1 WEIGHT SHEET 1/1

D

A

1

1

Luminaire: LEDiL Oy C13233\_HB-2X2-M\_(WICOP2\_Z8Y15)

Lamps: 1 x SEOUL\_WICOP2\_Z8Y15\_336.842lm@250mA\_P=2.9399W\_I=0.250A

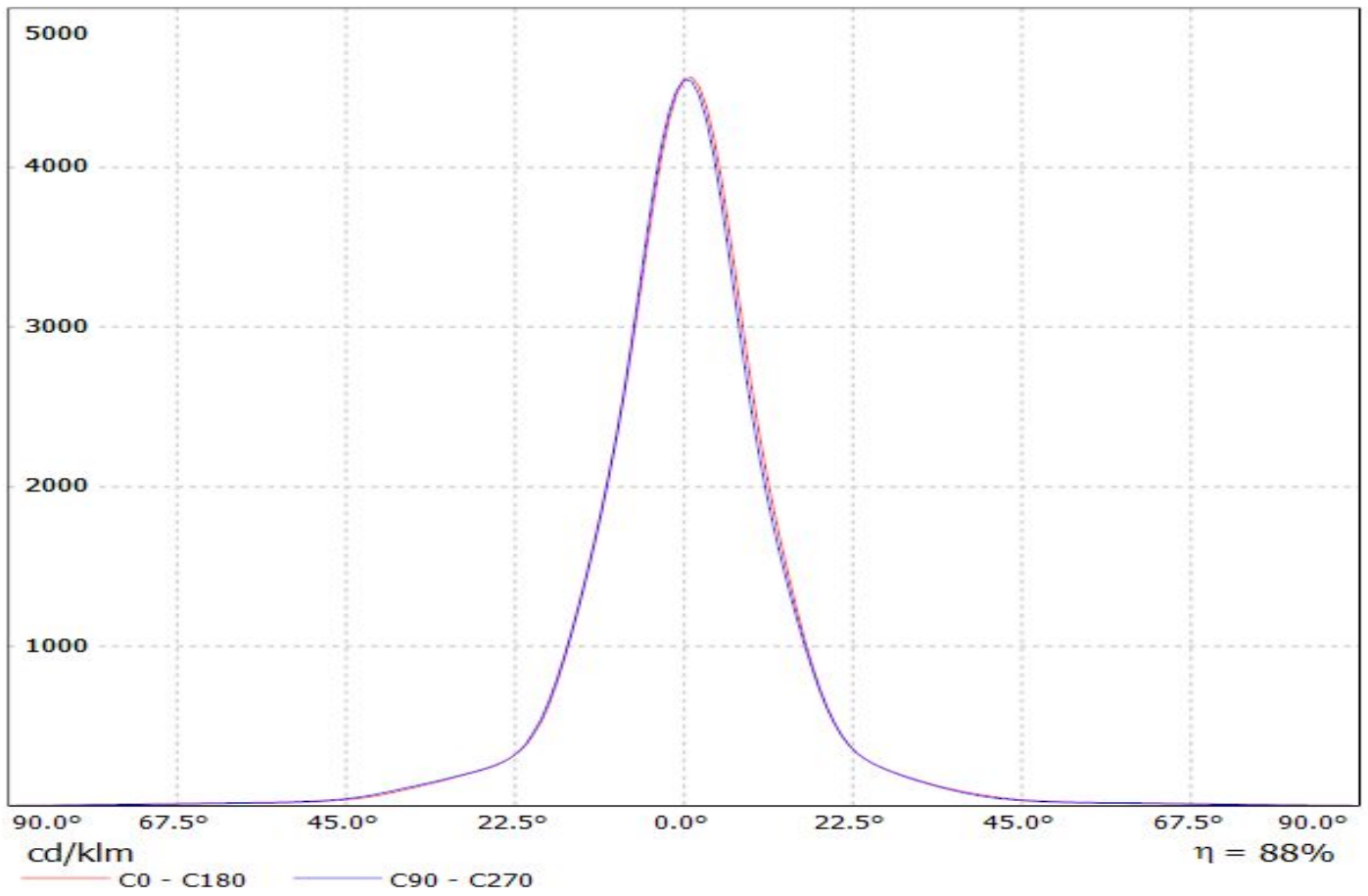

Luminaire: Ledil Oy C13233\_HB-2X2-M\_(Luxeon\_Z\_ES) Efficiency=91%  
Lamps: 1 x Luxeon Z ES (LXZ2-3090) 209lm @ 250mA CCT=3000K P=2.8W I=250mA

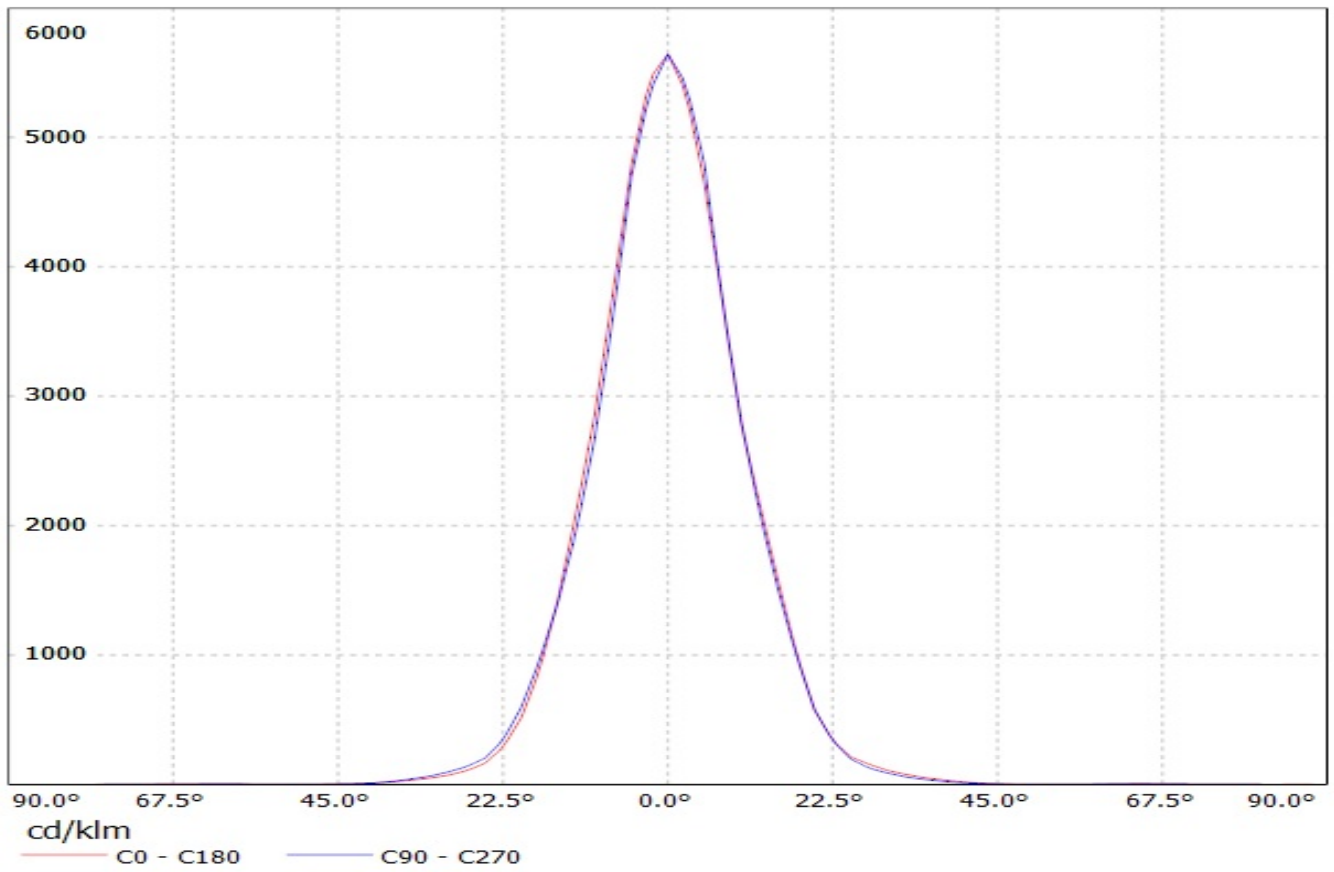

Luminaire: LEDiL Oy C13233\_HB-2X2-M\_(WICOP2\_Z8Y19)

Lamps: 1 x SEOUL\_WICOP2\_Z8Y19\_450.124lm@250mA\_P=2.8579W\_I=0.250A

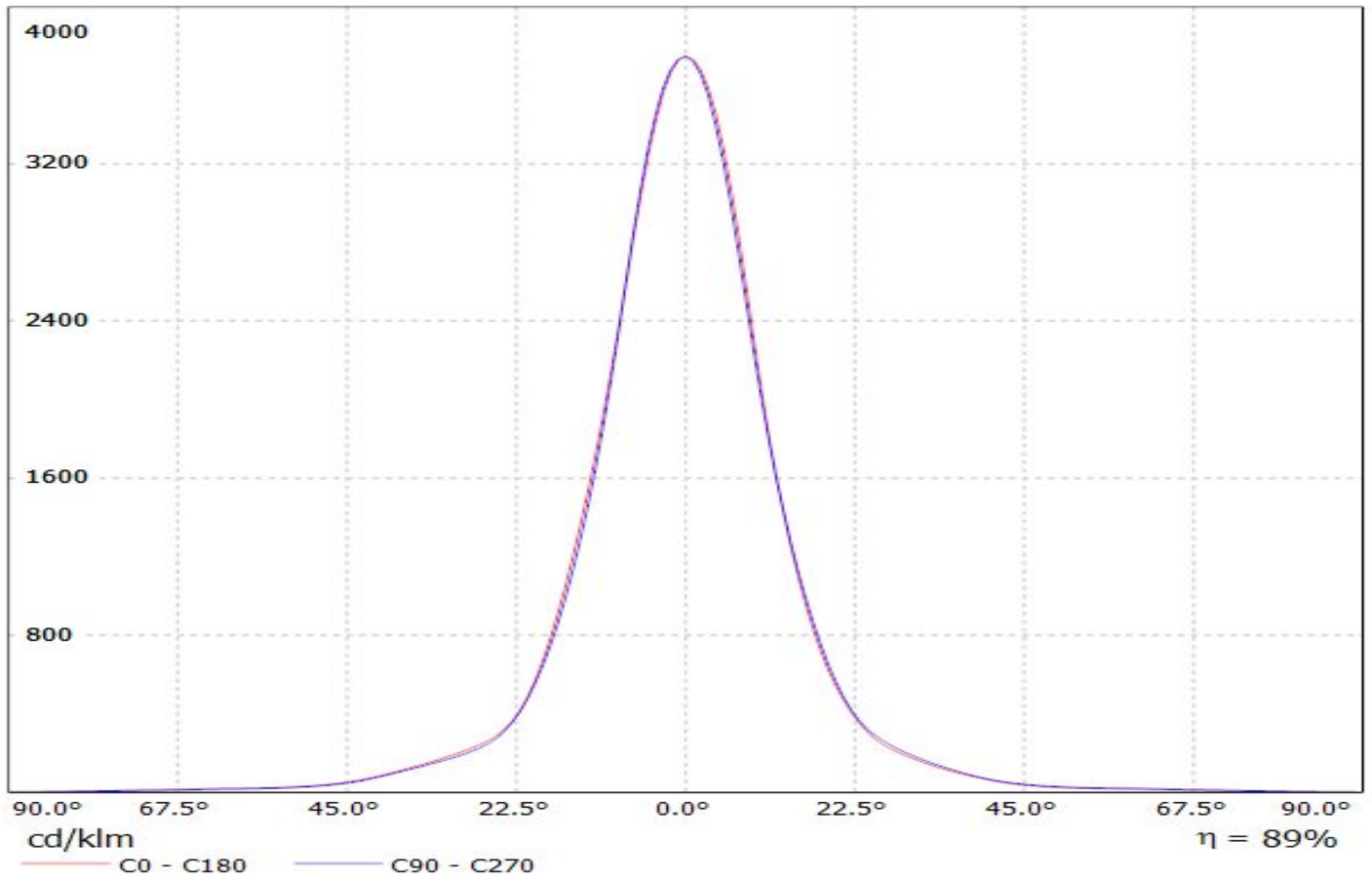

Luminaire: Ledil Oy C13233\_HB-2x2-M (Cree XT-E 390lm @ 250mA) Efficiency=92%  
Lamps: 1 x Cree XT-E 390lm @ 250mA

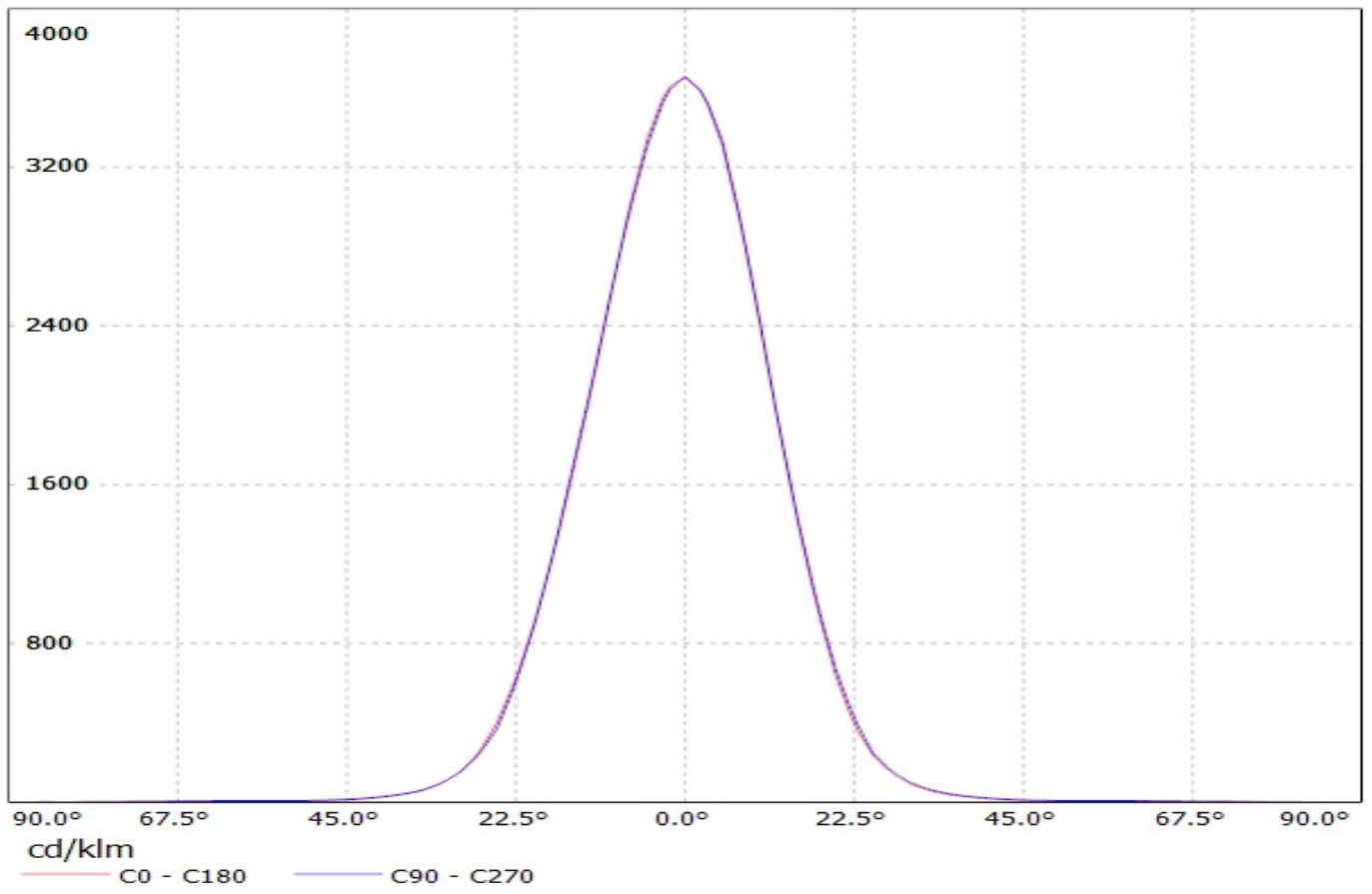

# Ledil C13233\_HB-2X2-M\_(TL1L4) / LDC (Linear)

Luminaire: Ledil C13233\_HB-2X2-M\_(TL1L4)

Lamps: 1 x Toshiba\_TL1L4\_2x2\_(TL1L4-DW0)\_472.639lm@250mA\_CCT=6500K\_P=2.9W\_I=0.25A

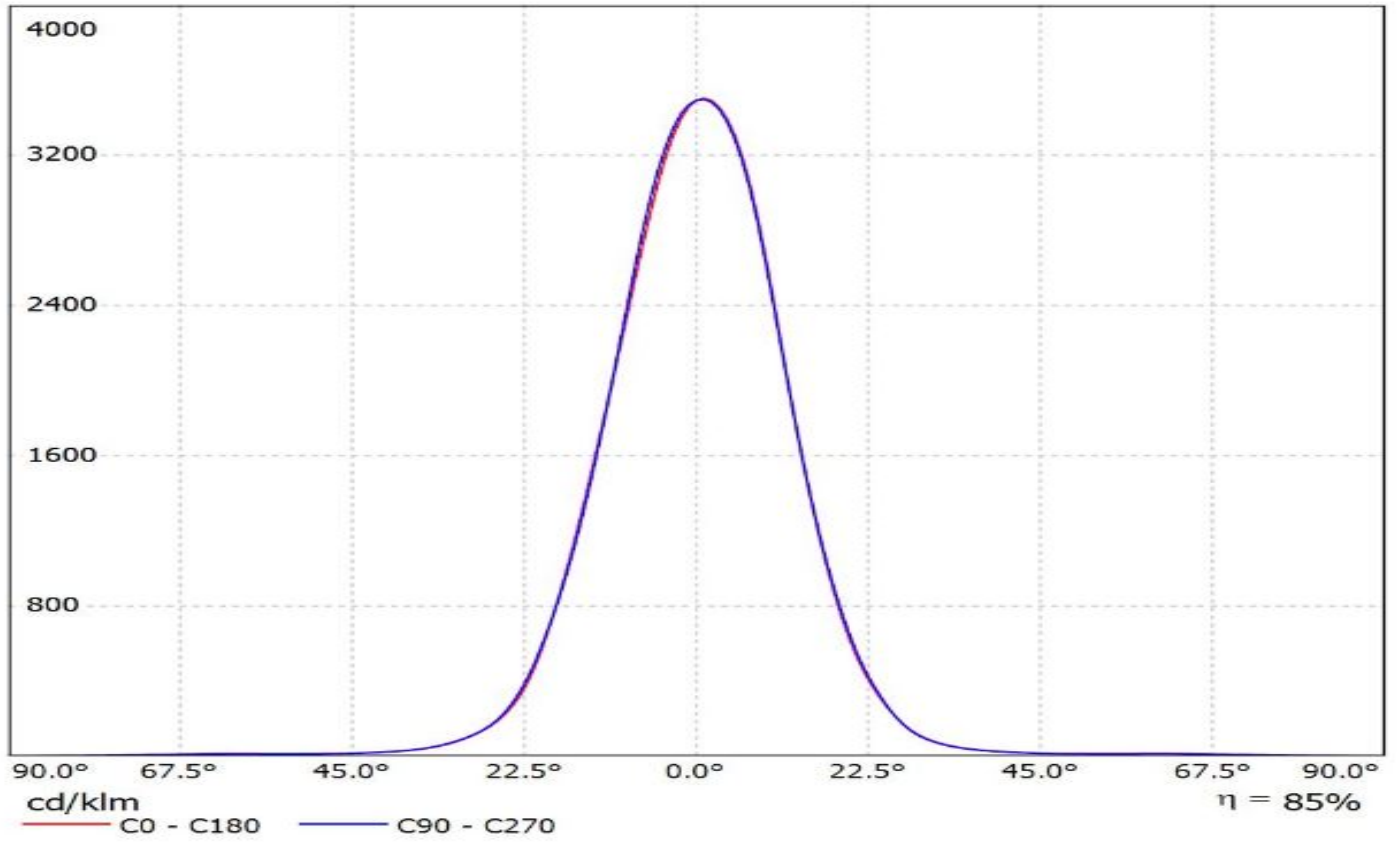

**LEDiL Oy C13233\_HB-2x2-M\_(XB-D) Eff.95.2% / LDC (Linear)**

Luminaire: LEDiL Oy C13233\_HB-2x2-M\_(XB-D) Eff.95.2%  
Lamps: 1 x CREE\_XB-D\_2x2 (362.885lm@250mA)

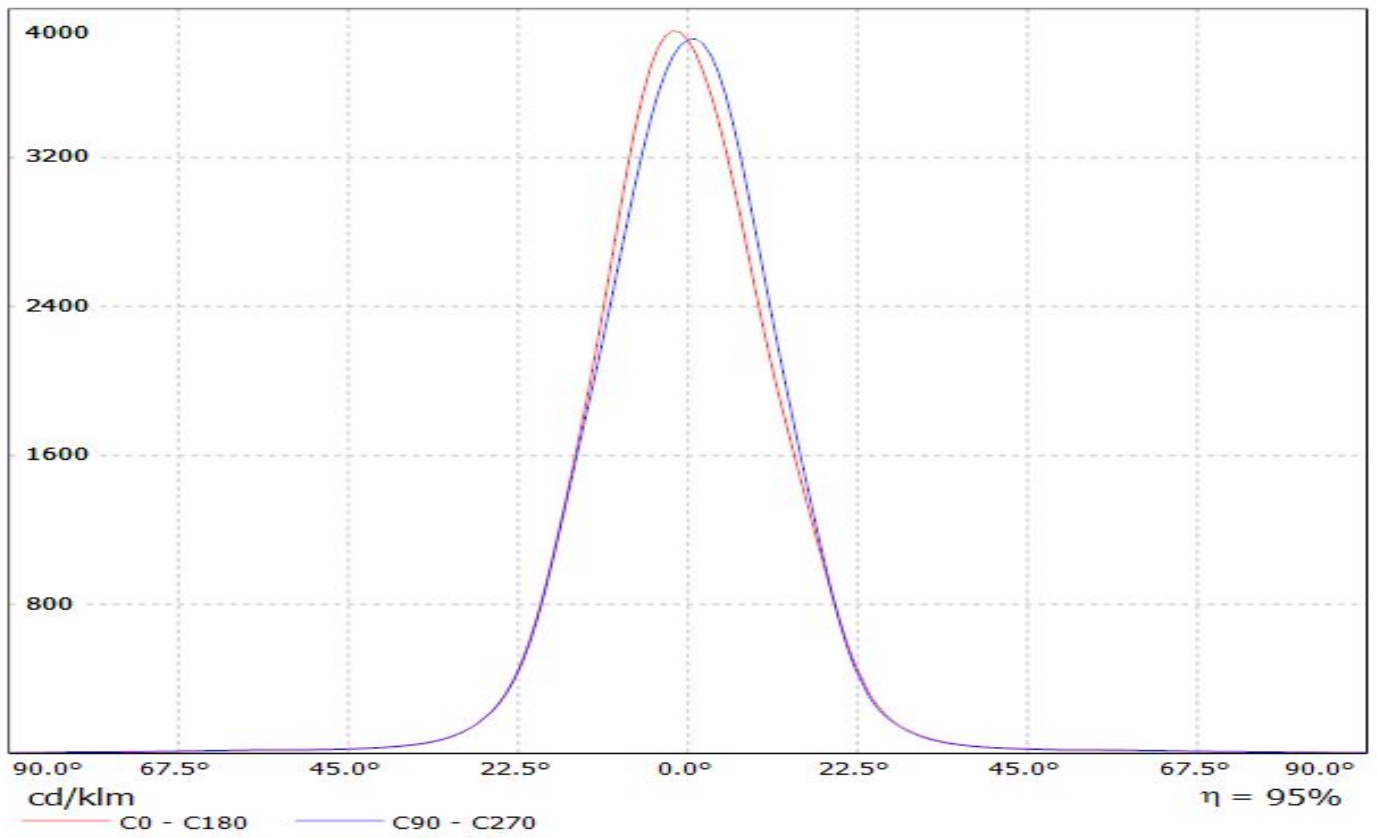



Luminaire: LEDiL Oy C13233\_HB-2X2-M\_(LUXEON\_Q) Eff.94.5%  
Lamps: 1 x LUXEON\_Q\_2x2\_(LHQ-3080)\_298.363lm@250mA\_P=2.87385W\_I=249.9mA

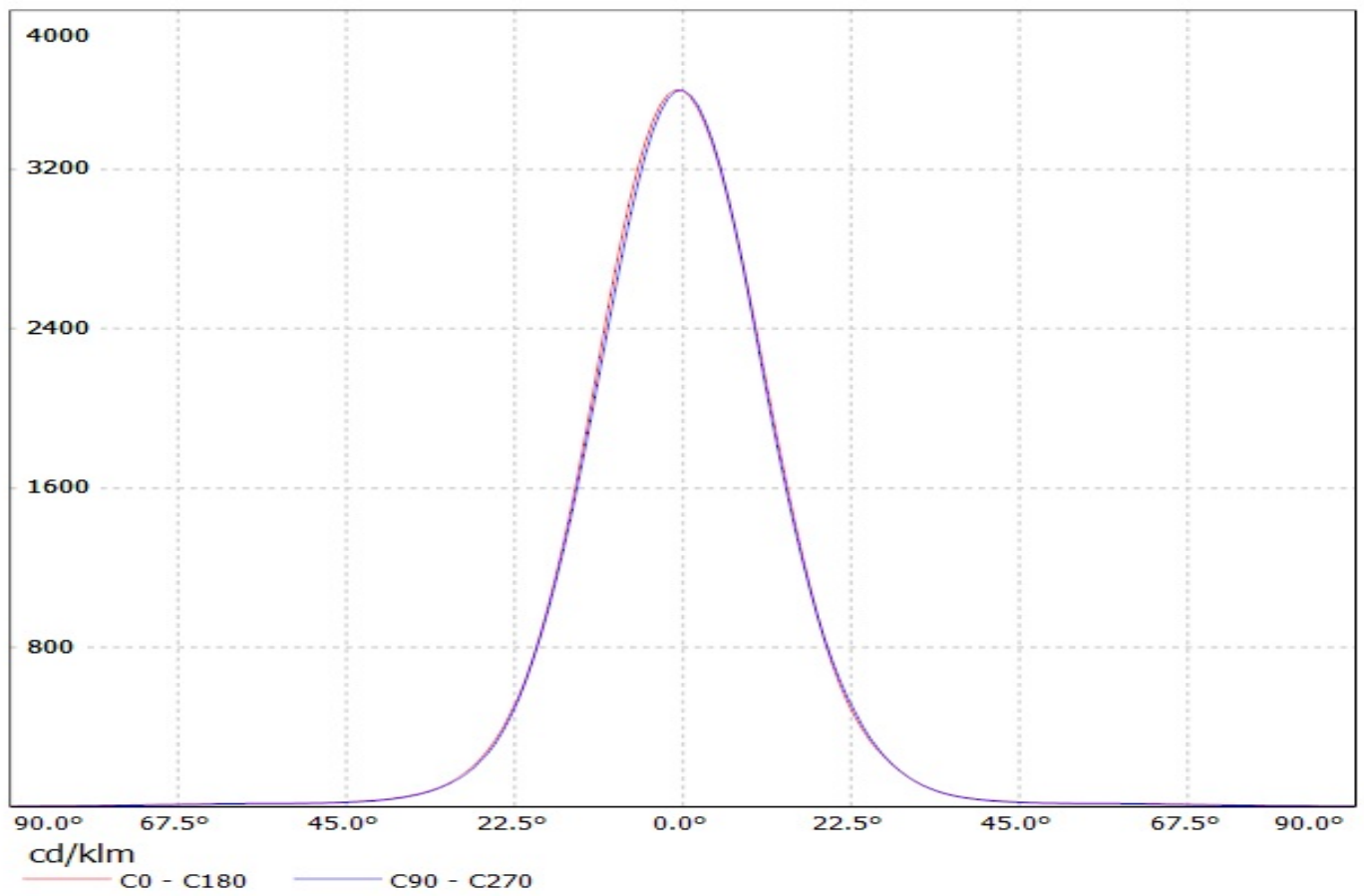

Luminaire: Ledil Oy C13233\_HB-2x2-M (Nichia 219B 306lm @ 250mA) Efficiency=91%  
Lamps: 1 x Nichia 219B 306lm @ 250mA

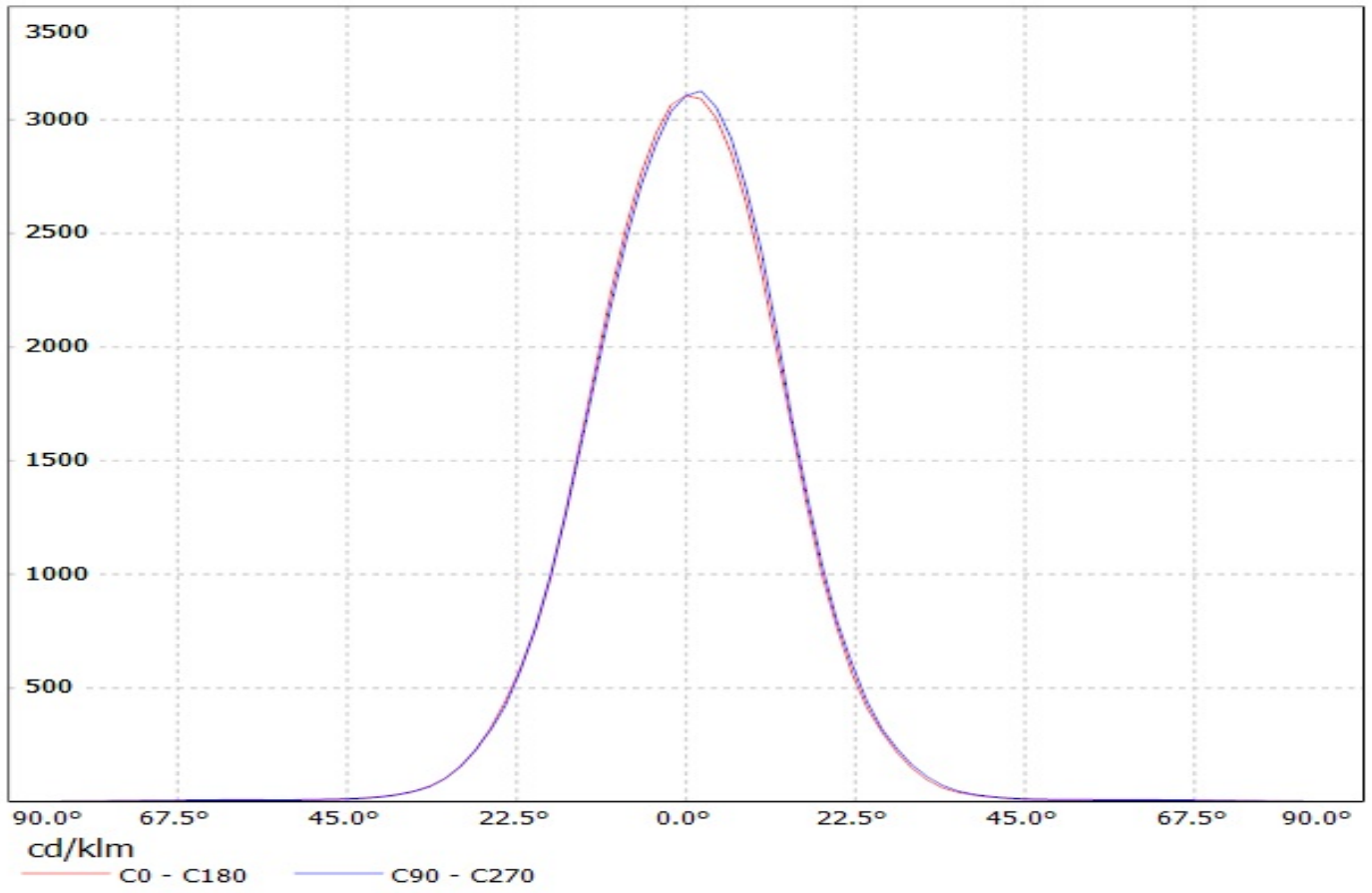

Luminaire: Ledil Oy C13233\_HB-2x2-M\_(3535\_Ceramic\_gen2) Efficiency=91%  
Lamps: 1 x LG 3535 Ceramic gen2 (PKG5700K) 461lm @ 250mA CCT=6600K P=2.9W I=250mA

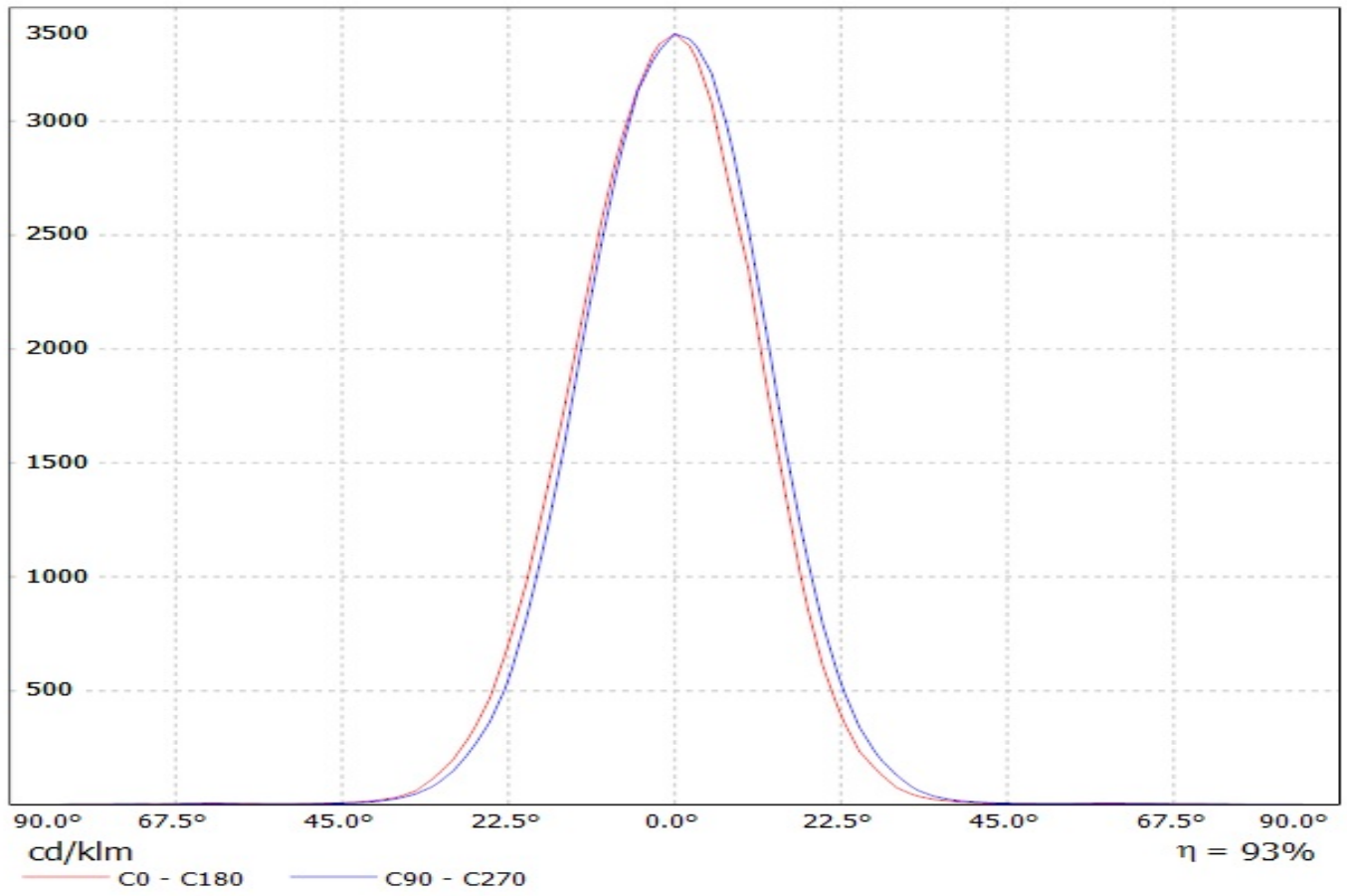

Luminaire: Ledil Oy (Osram Square PC 398lm @ 250mA) Efficiency=91%  
Lamps: 1 x Osram Square PC 398lm @ 250mA

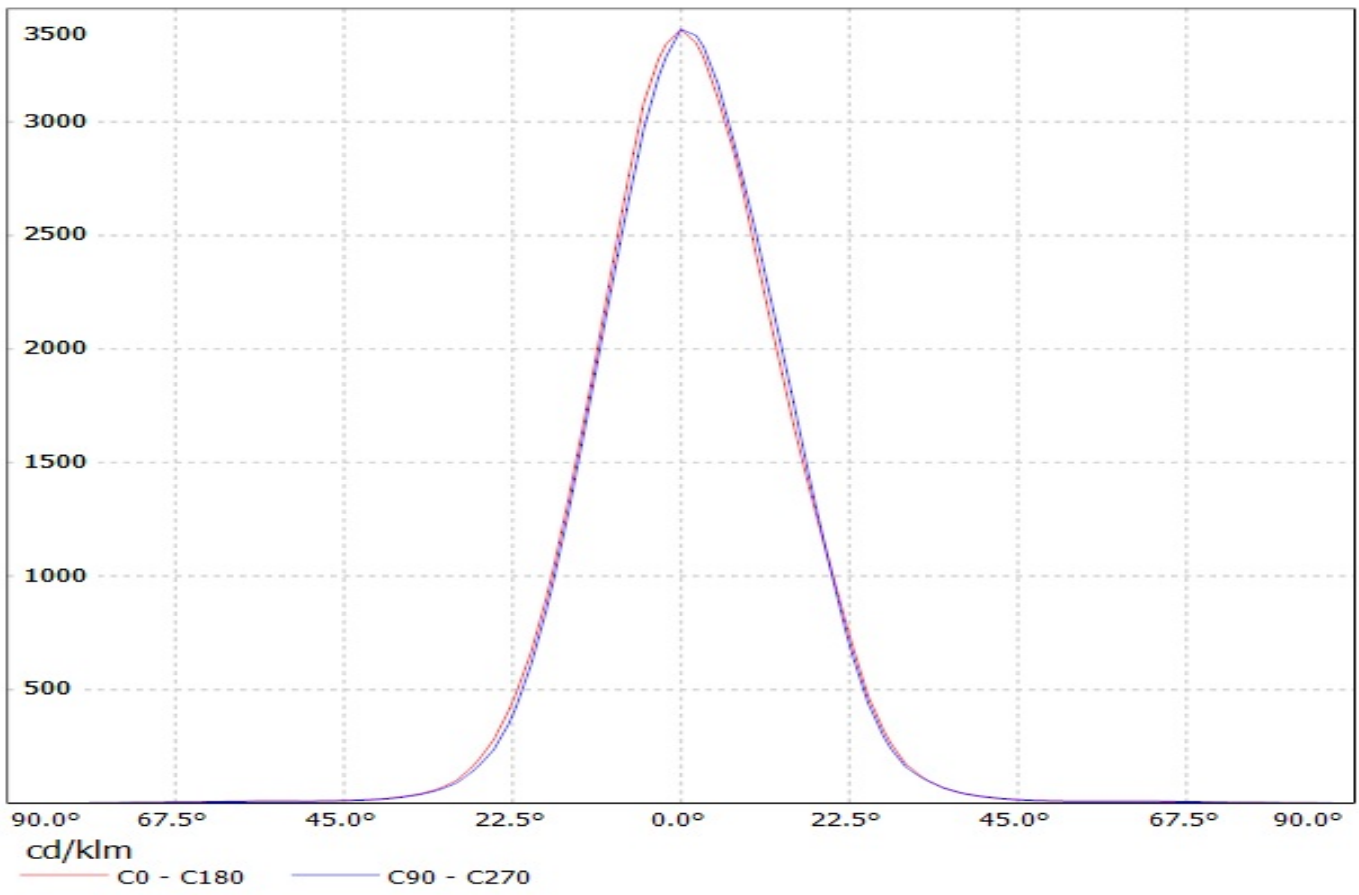

Luminaire: LEDil Oy C13233\_HB-2X2-M\_(Z5M1) Efficiency=90%  
Lamps: 1 x Seoul Z5M1 (SZ5-M1-WN-C8) 379lm @ 250mA CCT=4600K P=2.9W I=250mA

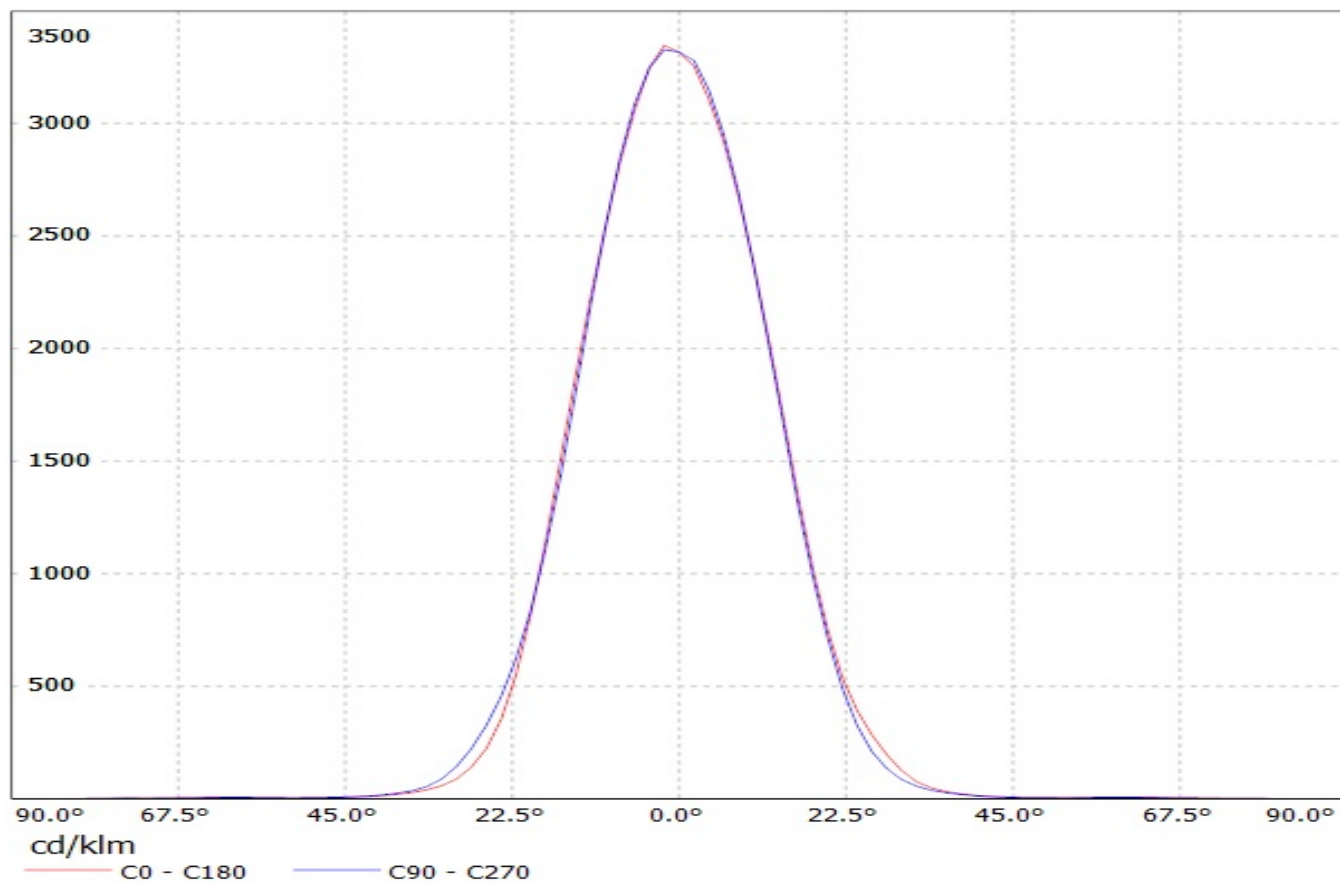

Luminaire: Ledil Oy C13233\_HB-2x2-M (Cree XP-G 257lm @ 250mA) Efficiency=91%  
Lamps: 1 x Cree XP-G 257lm @ 250mA

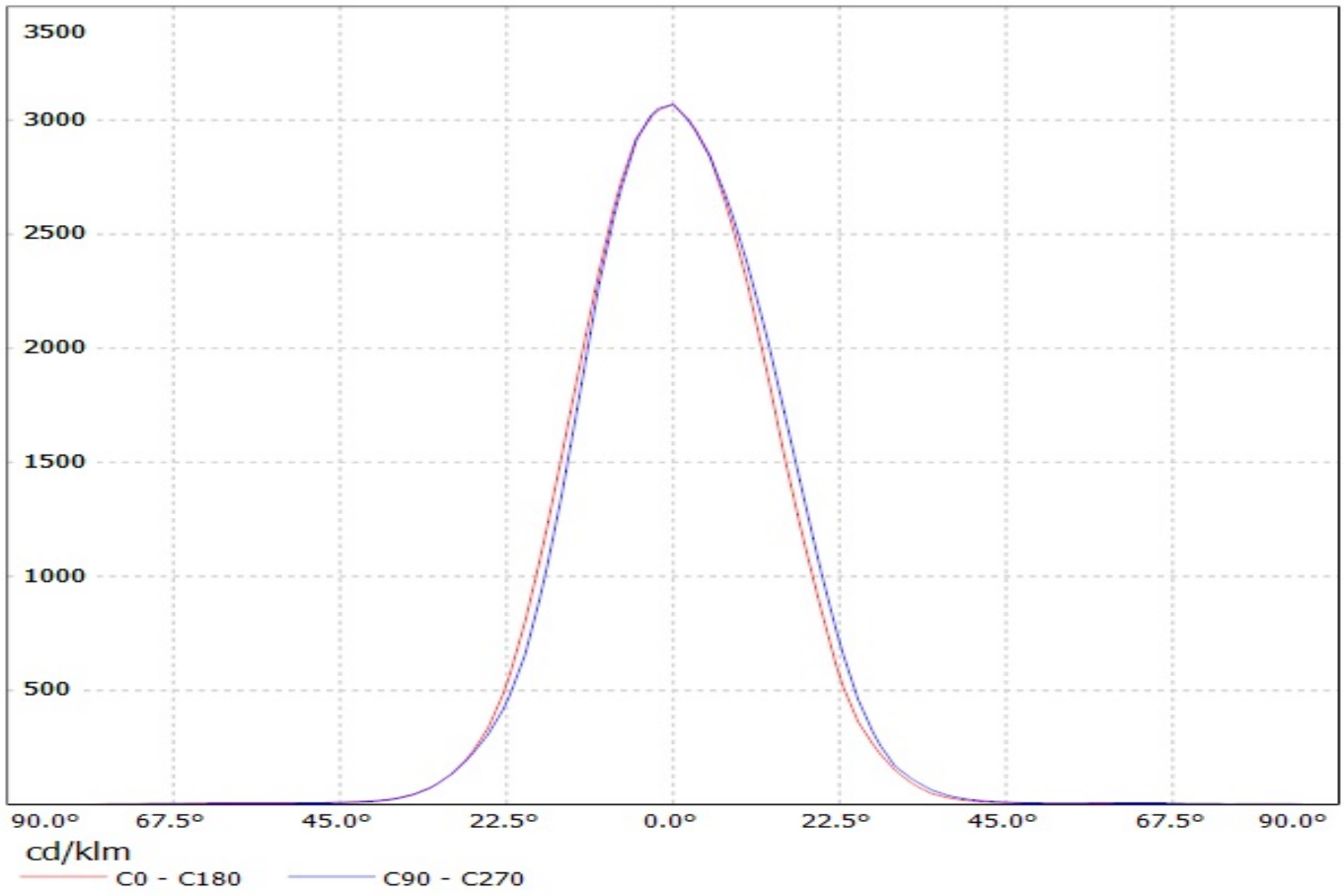

Luminaire: LEDiL Oy C13233\_HB-2X2-M\_(LH351B) Eff.93.6%  
Lamps: 1 x SAMSUNG\_LH351B\_2x2\_430.715lm@250mA\_P=2.84311W\_I=249.9mA

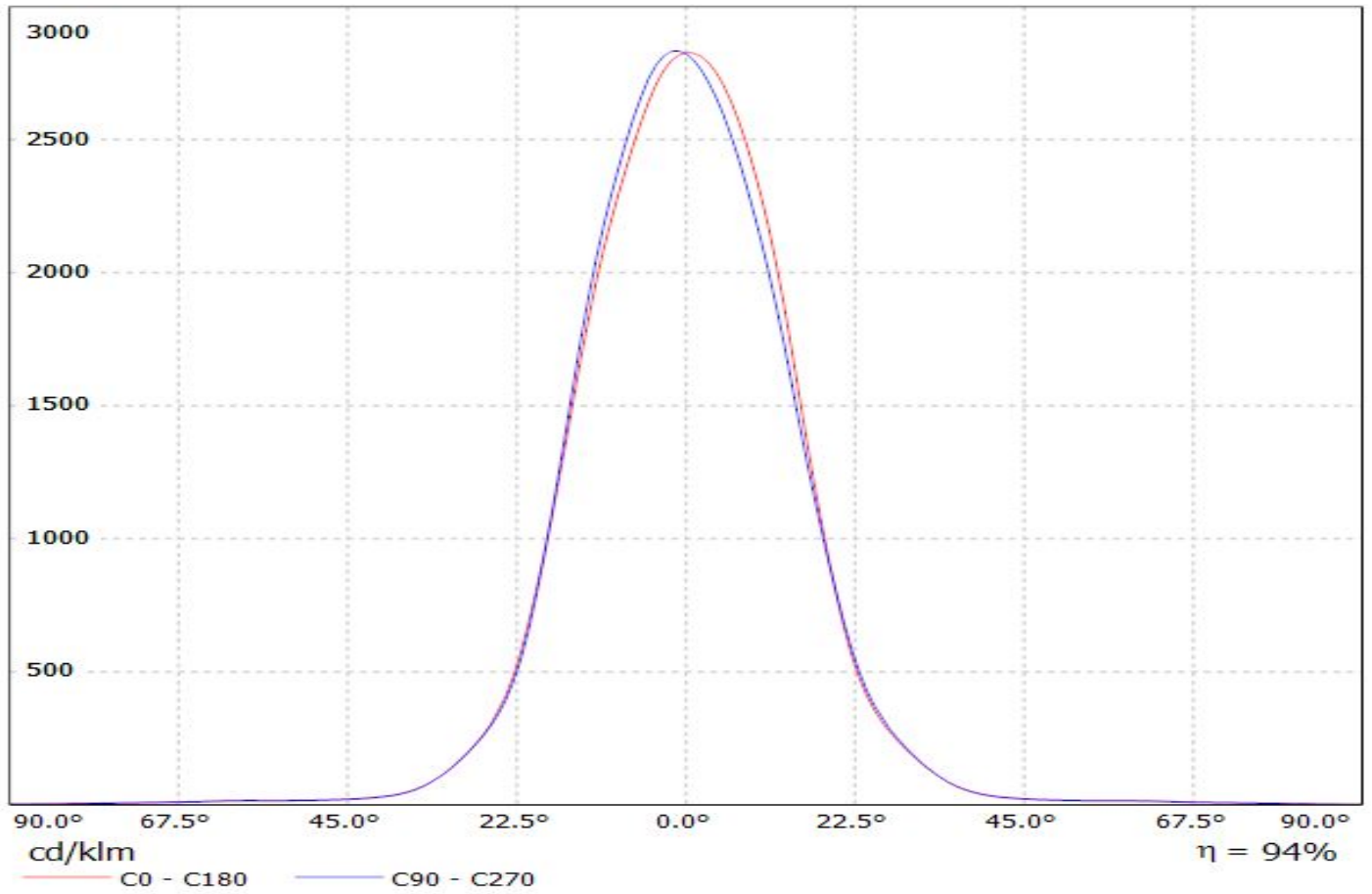

Luminaire: LEDiL Oy C13233\_HB-2X2-M\_(LH351Z) Eff.93.0%  
Lamps: 1 x SAMSUNG\_LH351Z\_2x2\_359.49lm@250mA\_P=2.86371W\_I=249.8mA

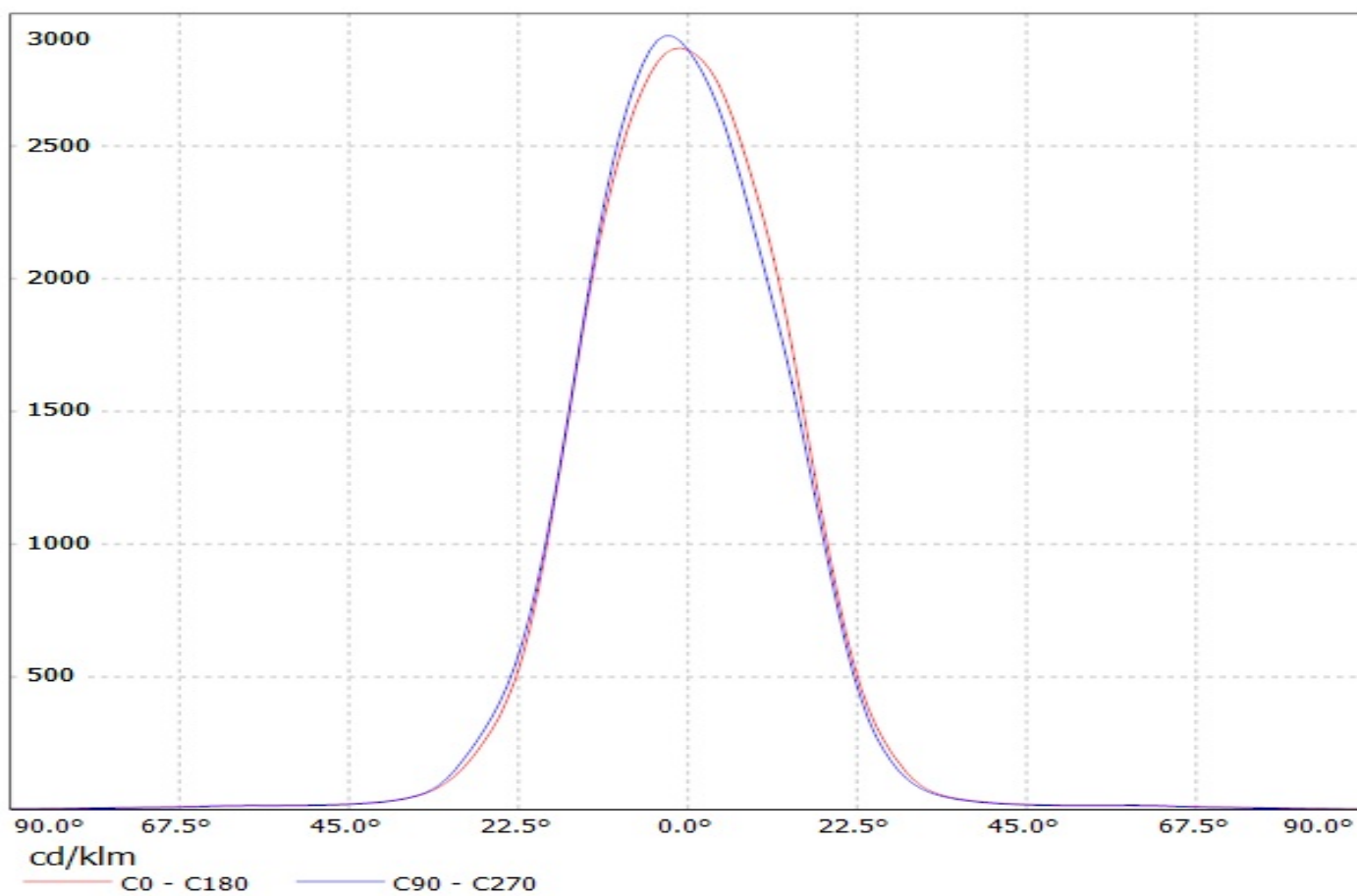



Luminaire: Ledil Oy C13233\_HB-2x2-M (Cree XP-G2 420lm @ 250mA) Efficiency=93%  
Lamps: 1 x Cree XP-G2 420lm @ 250mA

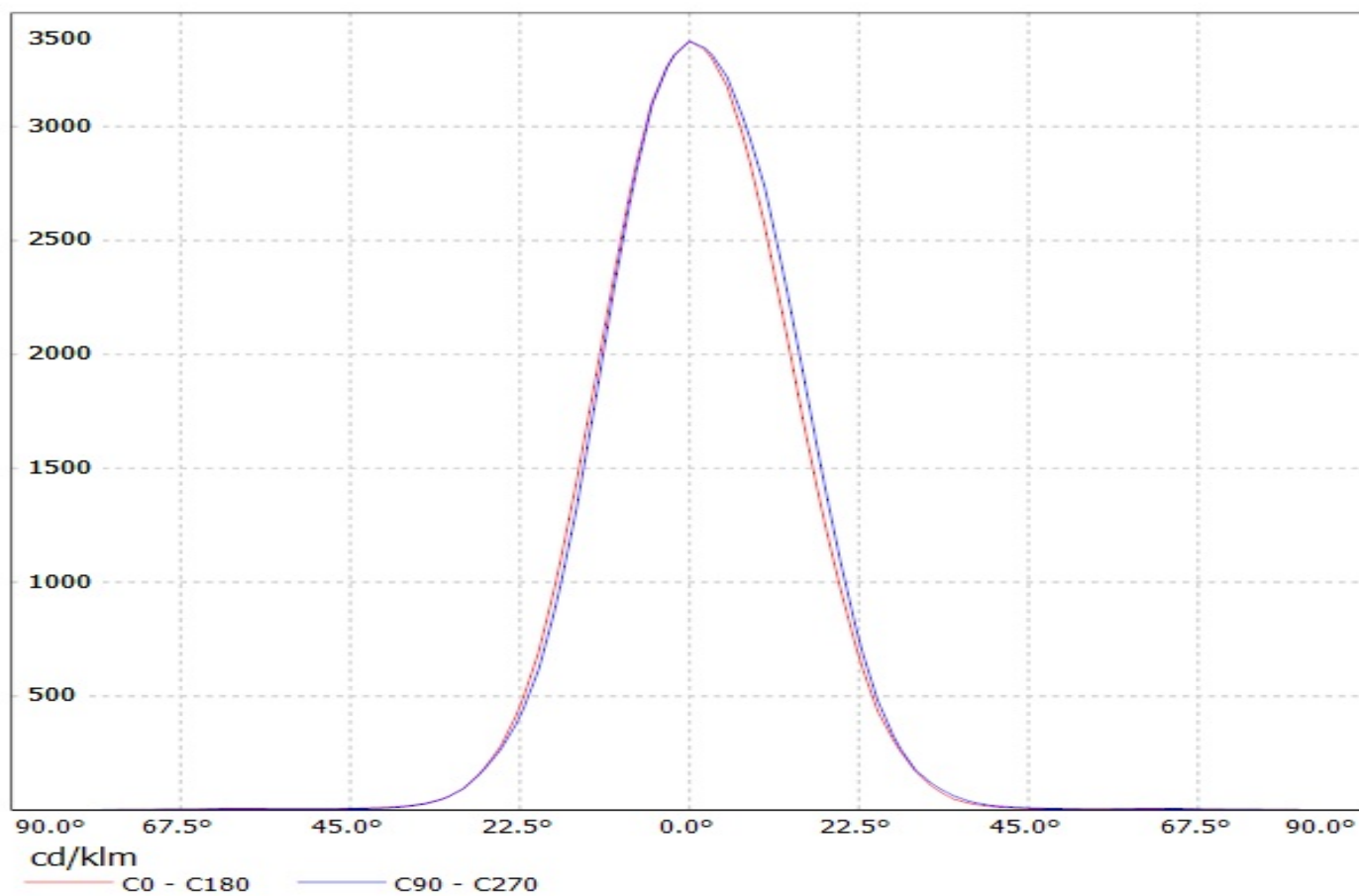

Luminaire: LEDiL Oy C13233\_HB-2X2-M\_(WICOP2\_Z8Y15)

Lamps: 1 x SEOUL\_WICOP2\_Z8Y15\_336.842lm@250mA\_P=2.9399W\_I=0.250A

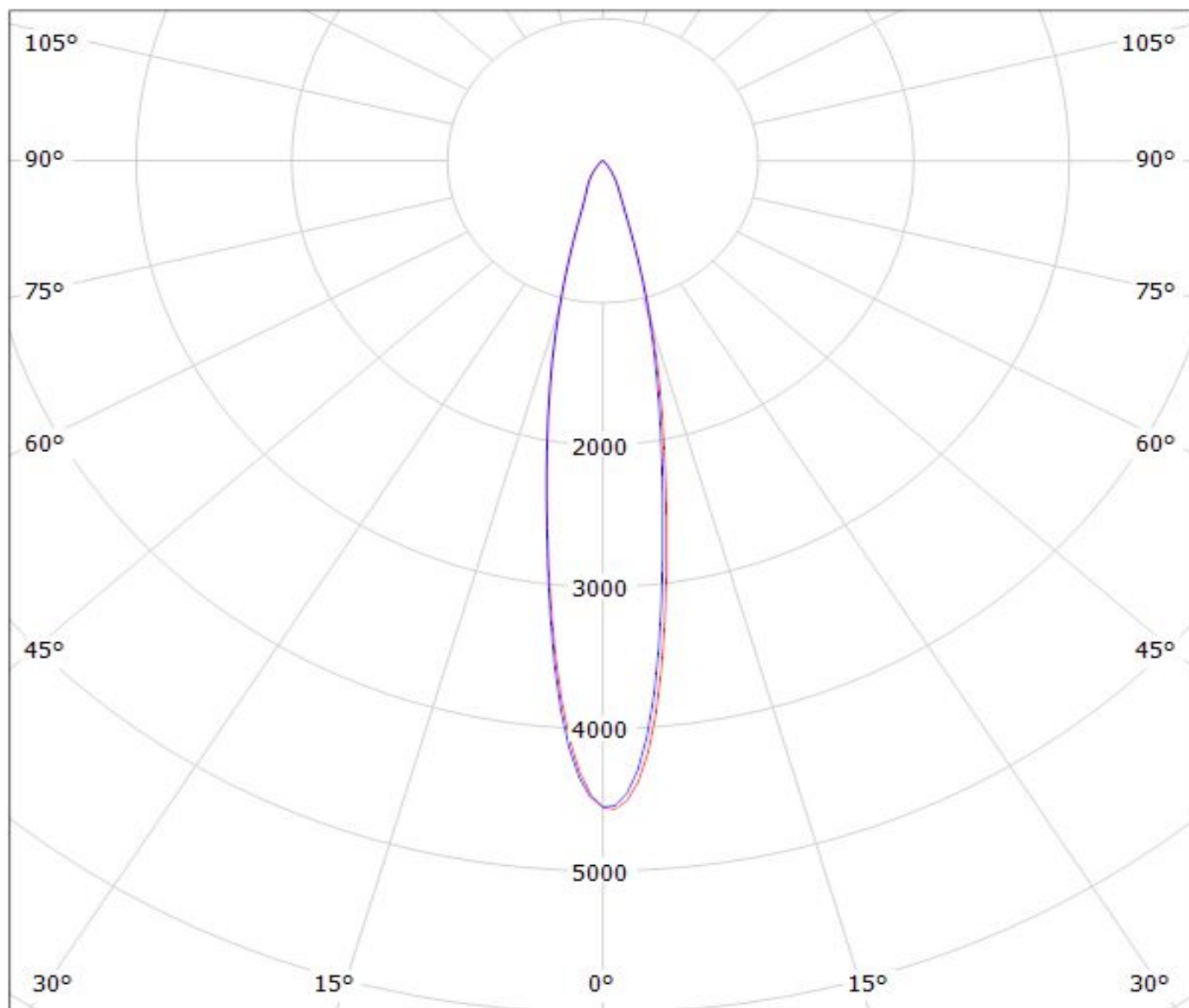

cd/klm

— C0 - C180

— C90 - C270

$\eta = 88\%$

Luminaire: Ledil Oy C13233\_HB-2X2-M\_(Luxeon\_Z\_ES) Efficiency=91%  
Lamps: 1 x Luxeon Z ES (LXZ2-3090) 209lm @ 250mA CCT=3000K P=2.8W I=250mA

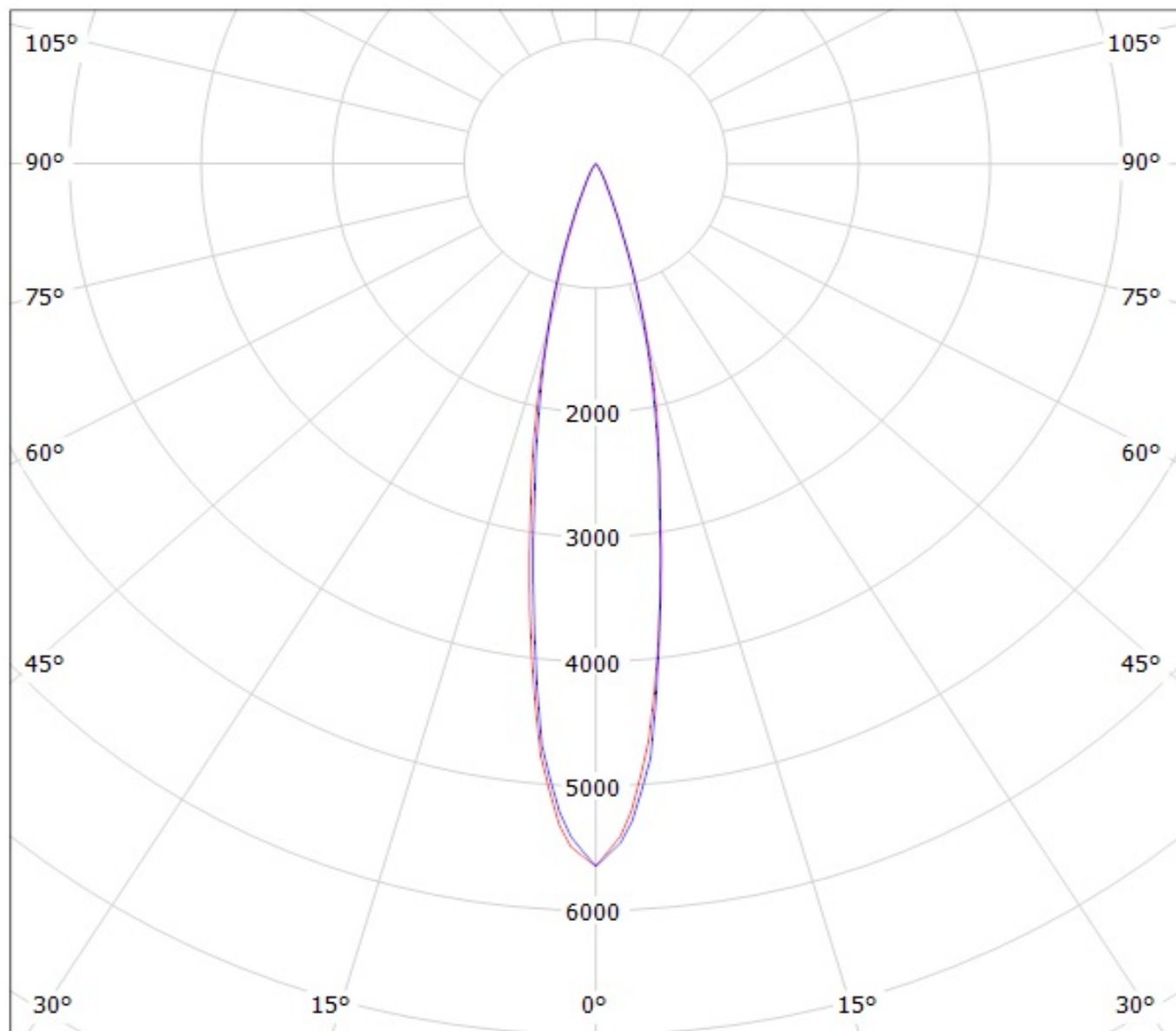

cd/klm

— C0 - C180

— C90 - C270

Luminaire: LEDiL Oy C13233\_HB-2X2-M\_(WICOP2\_Z8Y19)

Lamps: 1 x SEOUL\_WICOP2\_Z8Y19\_450.124lm@250mA\_P=2.8579W\_I=0.250A

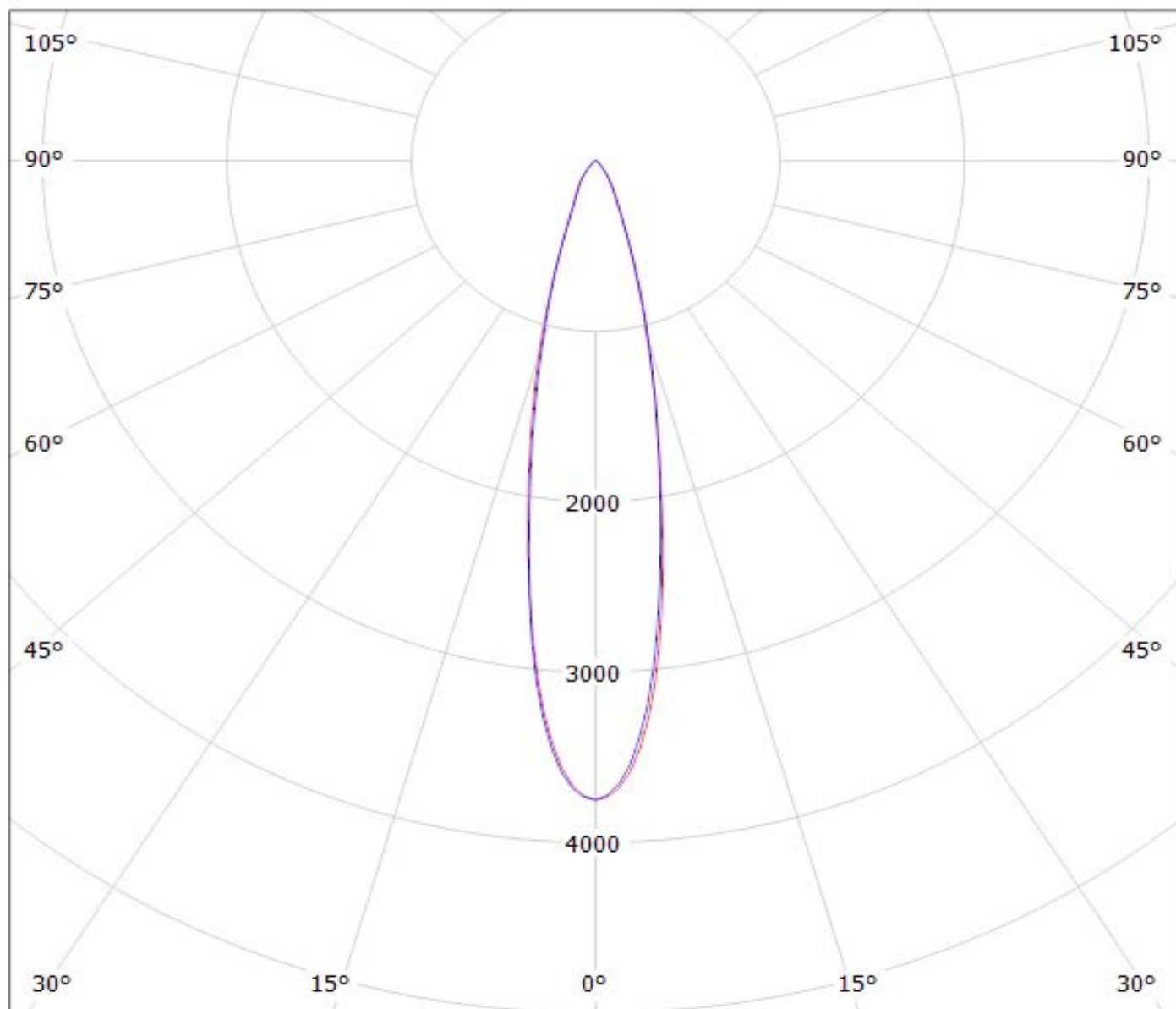

cd/klm

— C0 - C180

— C90 - C270

$\eta = 89\%$

Luminaire: Ledil Oy C13233\_HB-2x2-M (Cree XT-E 390lm @ 250mA) Efficiency=92%  
Lamps: 1 x Cree XT-E 390lm @ 250mA

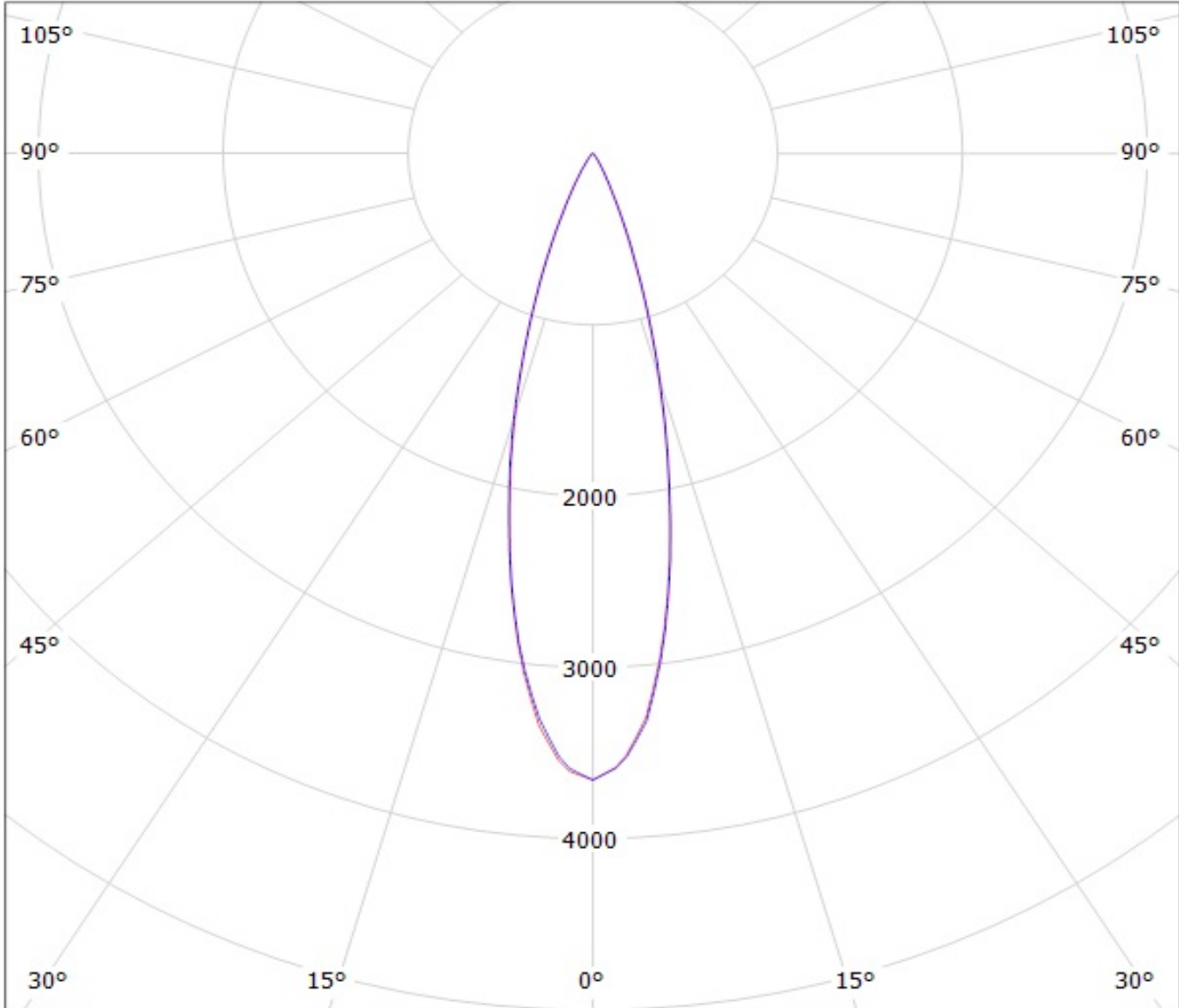

cd/klm

— C0 - C180    — C90 - C270

# Ledil C13233\_HB-2X2-M\_(TL1L4) / LDC (Polar)

Luminaire: Ledil C13233\_HB-2X2-M\_(TL1L4)

Lamps: 1 x Toshiba\_TL1L4\_2x2\_(TL1L4-DW0)\_472.639lm@250mA\_CCT=6500K\_P=2.9W\_I=0.25A

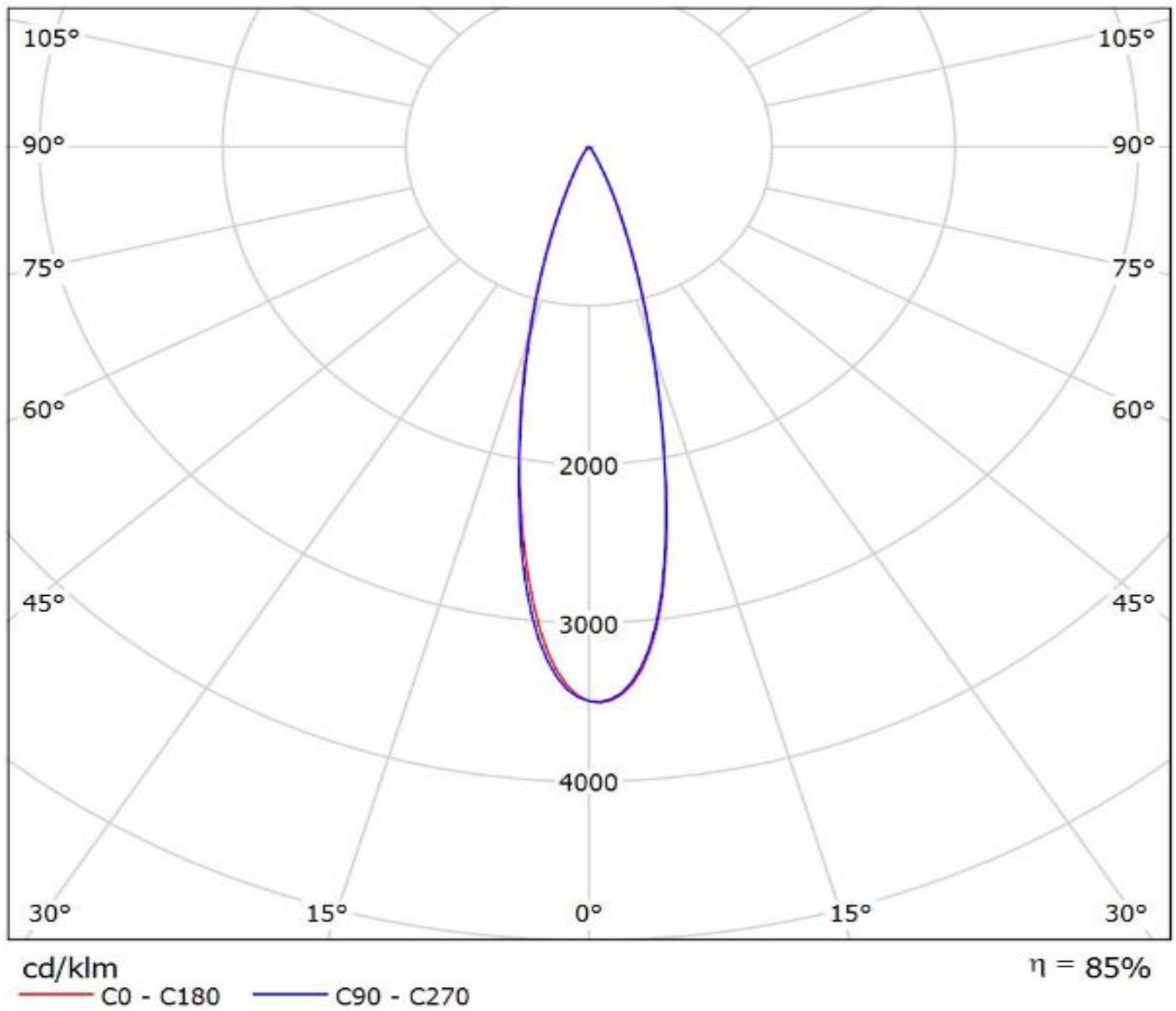

# LEDiL Oy C13233\_HB-2x2-M\_(XB-D) Eff.95.2% / LDC (Polar)

Luminaire: LEDiL Oy C13233\_HB-2x2-M\_(XB-D) Eff.95.2%

Lamps: 1 x CREE\_XB-D\_2x2 (362.885lm@250mA)

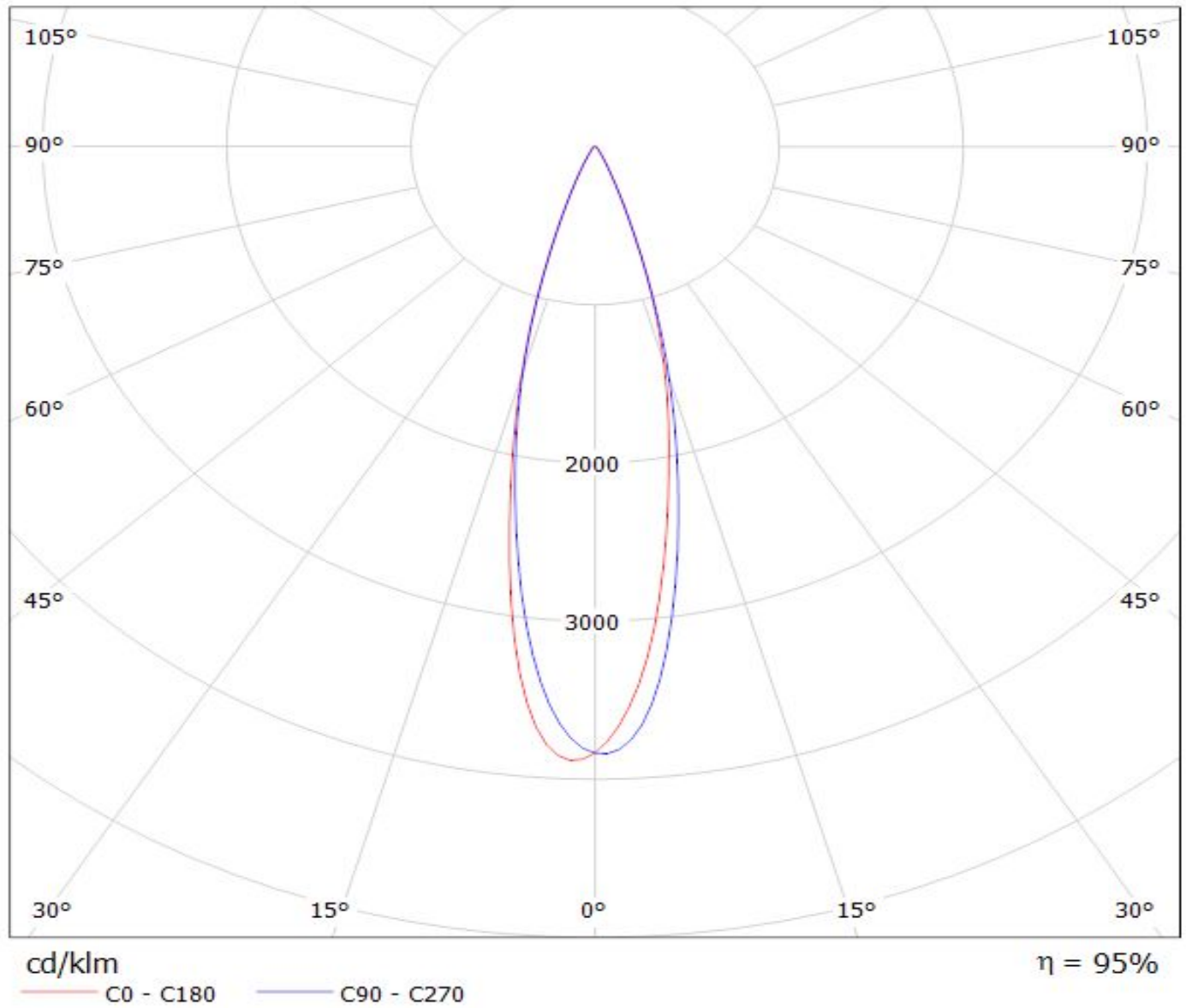



Luminaire: LEDiL Oy C13233\_HB-2X2-M\_(LUXEON\_Q)

Lamps: 1 x LUXEON\_Q\_2x2\_(LHQ-3080)\_298.363lm@250mA\_P=2.87385W\_I=249.9mA

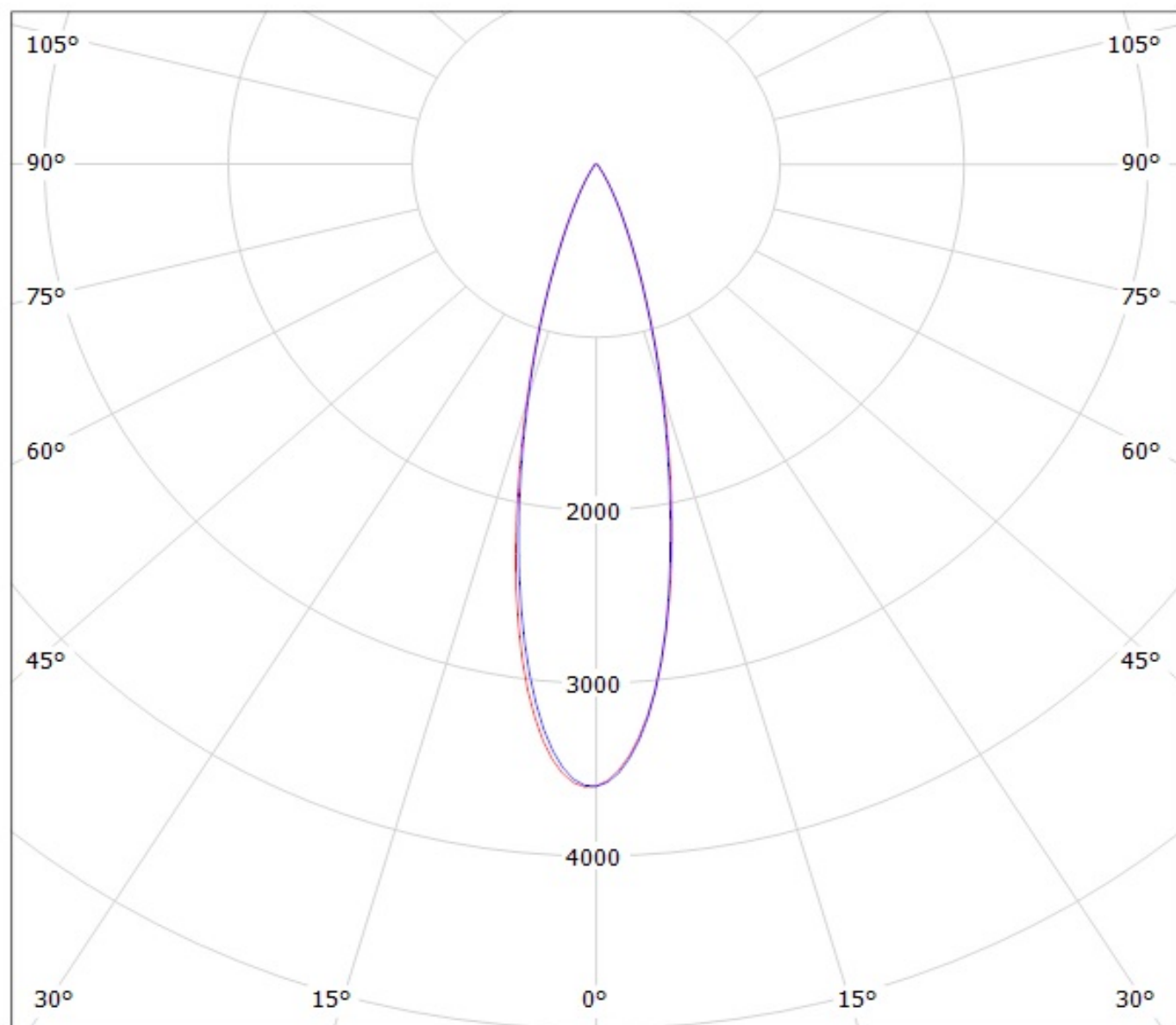

cd/klm

— C0 - C180

— C90 - C270



Luminaire: Ledil Oy C13233\_HB-2x2-M (Nichia 219B 306lm @ 250mA) Efficiency=91%  
Lamps: 1 x Nichia 219B 306lm @ 250mA

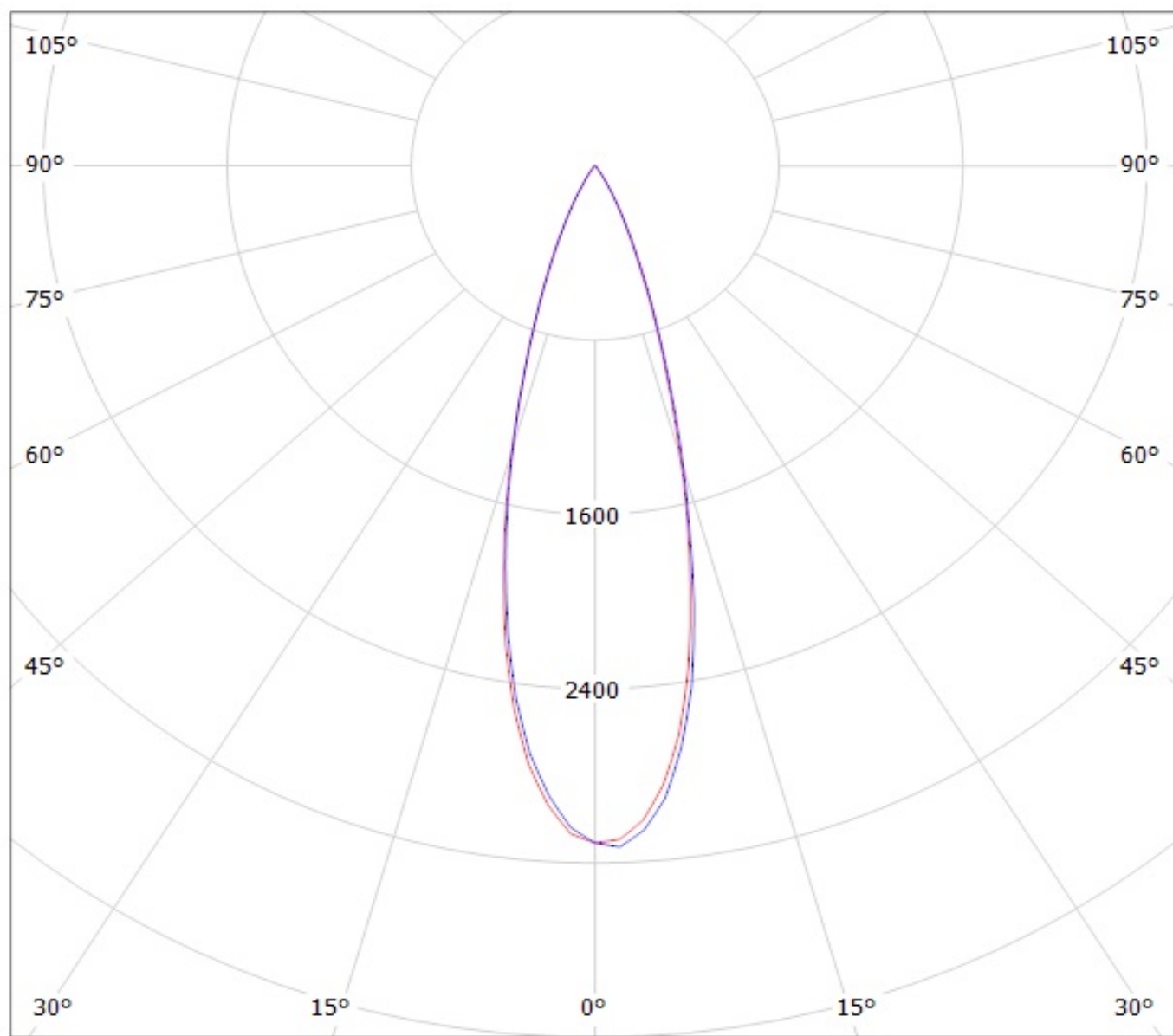

cd/klm

— C0 - C180

— C90 - C270

Luminaire: Ledil Oy C13233\_HB-2x2-M\_(3535\_Ceramic\_gen2) Efficiency=91%  
Lamps: 1 x LG 3535 Ceramic gen2 (PKG5700K) 461lm @ 250mA CCT=6600K P=2.9W I=250mA

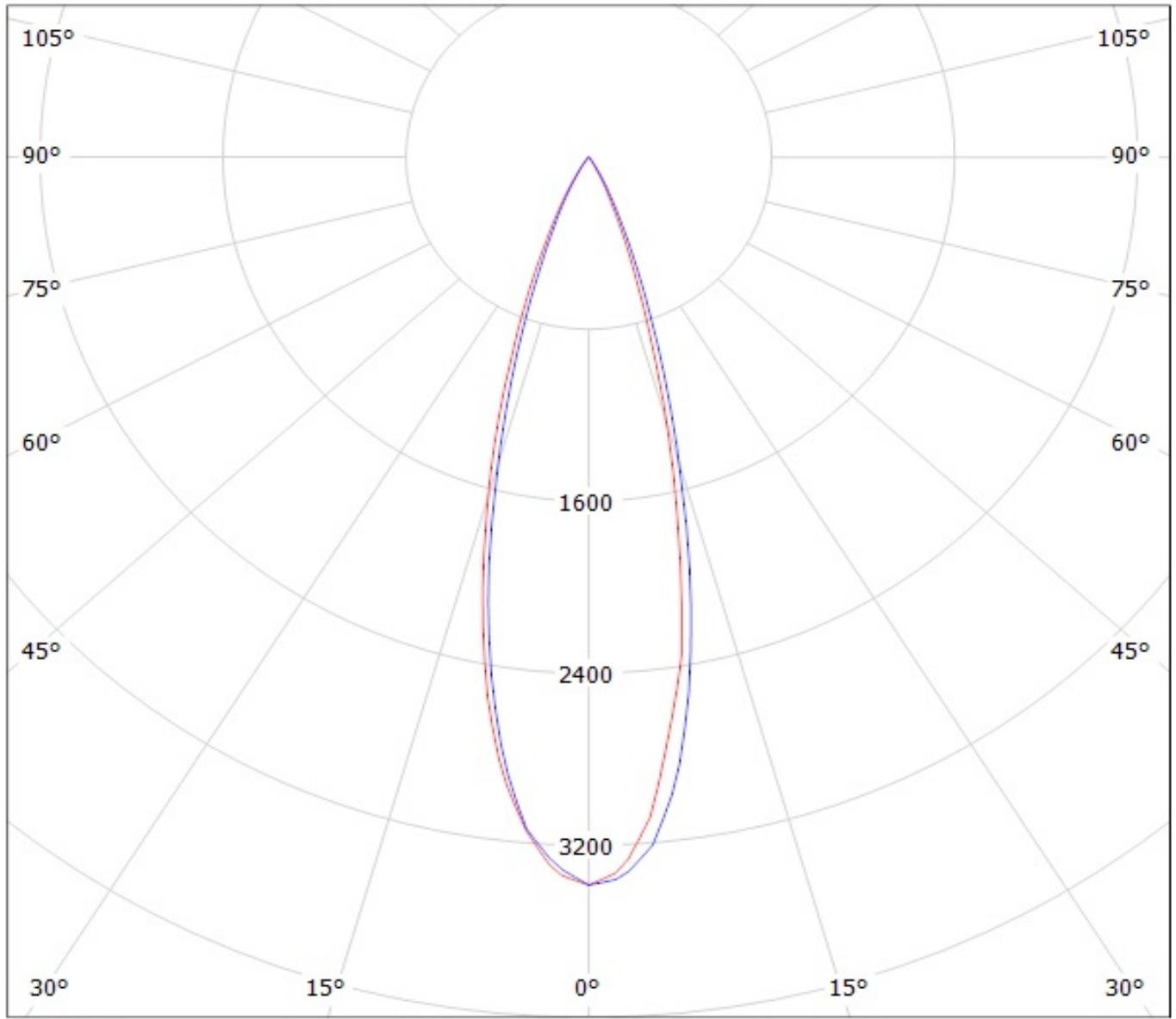

cd/klm

— C0 - C180    — C90 - C270

Luminaire: Ledil Oy (Osram Square PC 398lm @ 250mA) Efficiency=91%  
Lamps: 1 x Osram Square PC 398lm @ 250mA

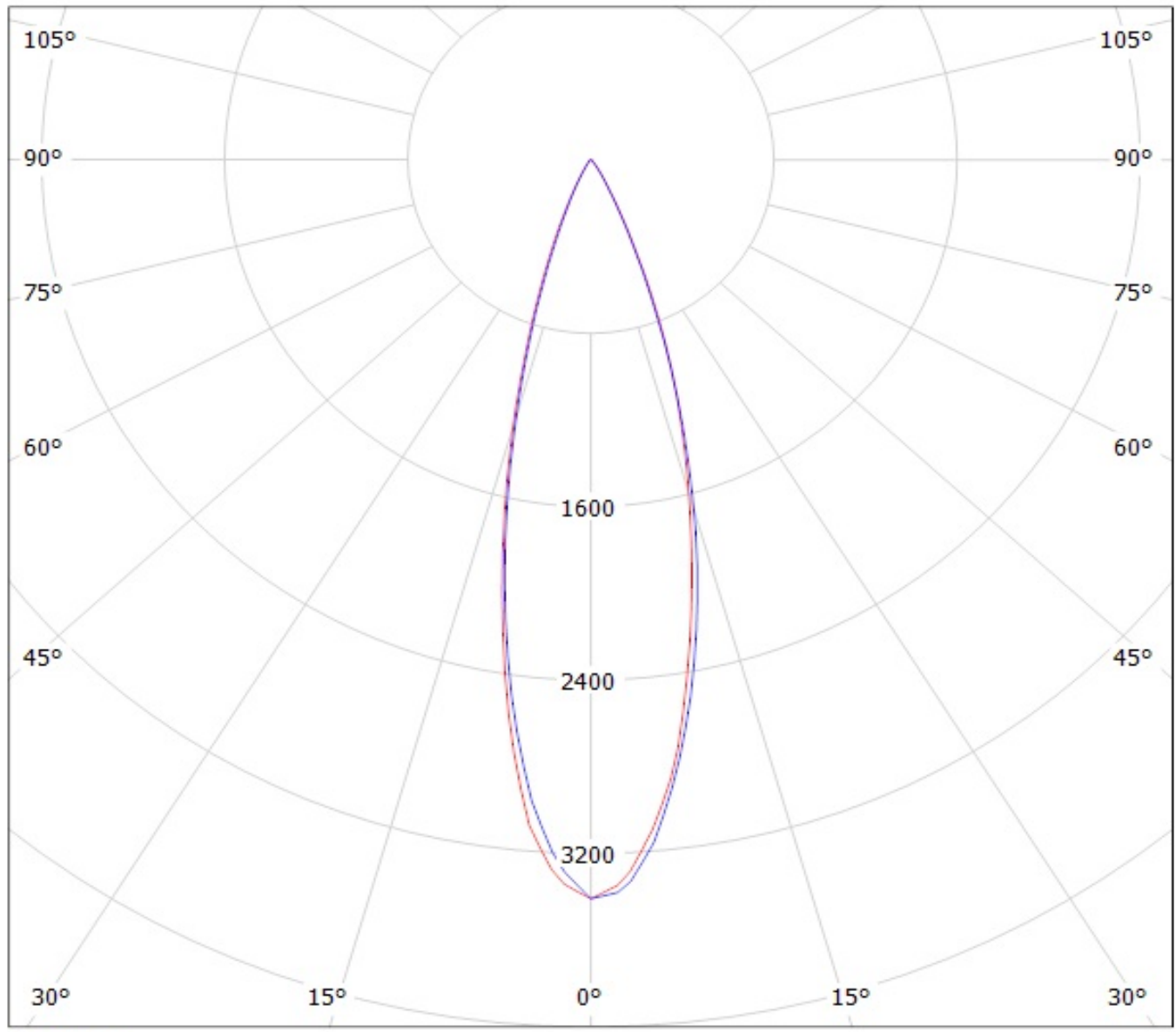

cd/klm  
— C0 - C180    — C90 - C270

Luminaire: LEDil Oy C13233\_HB-2X2-M\_(Z5M1) Efficiency=90%

Lamps: 1 x Seoul Z5M1 (SZ5-M1-WN-C8) 379lm @ 250mA CCT=4600K P=2.9W I=250mA

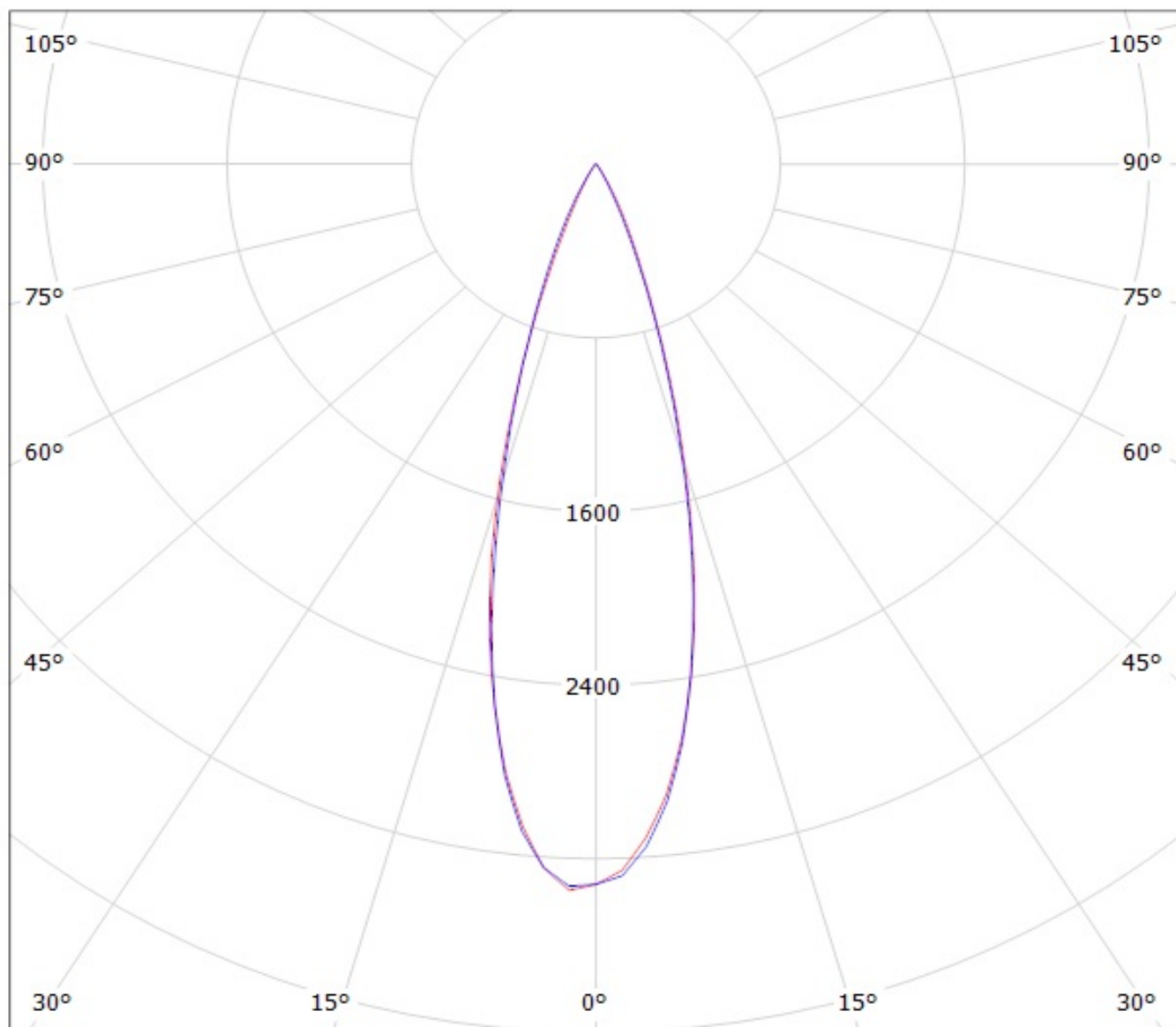

cd/klm

— C0 - C180

— C90 - C270

Luminaire: Ledil Oy C13233\_HB-2x2-M (Cree XP-G 257lm @ 250mA) Efficiency=91%  
Lamps: 1 x Cree XP-G 257lm @ 250mA

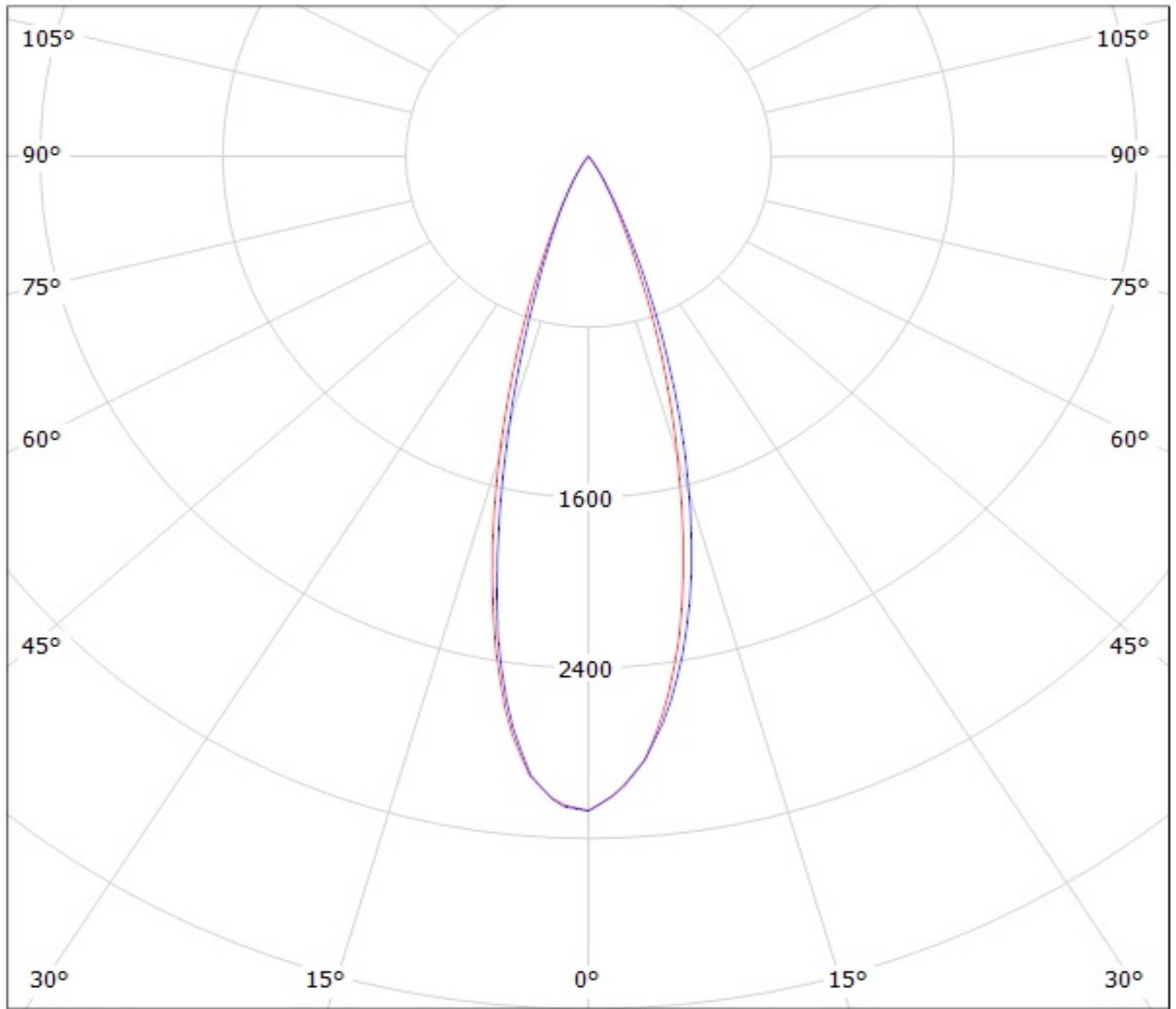

cd/klm

— C0 - C180

— C90 - C270

Luminaire: LEDiL Oy C13233\_HB-2X2-M\_(LH351B) Eff.93.6%

Lamps: 1 x SAMSUNG\_LH351B\_2x2\_430.715lm@250mA\_P=2.84311W\_I=249.9mA

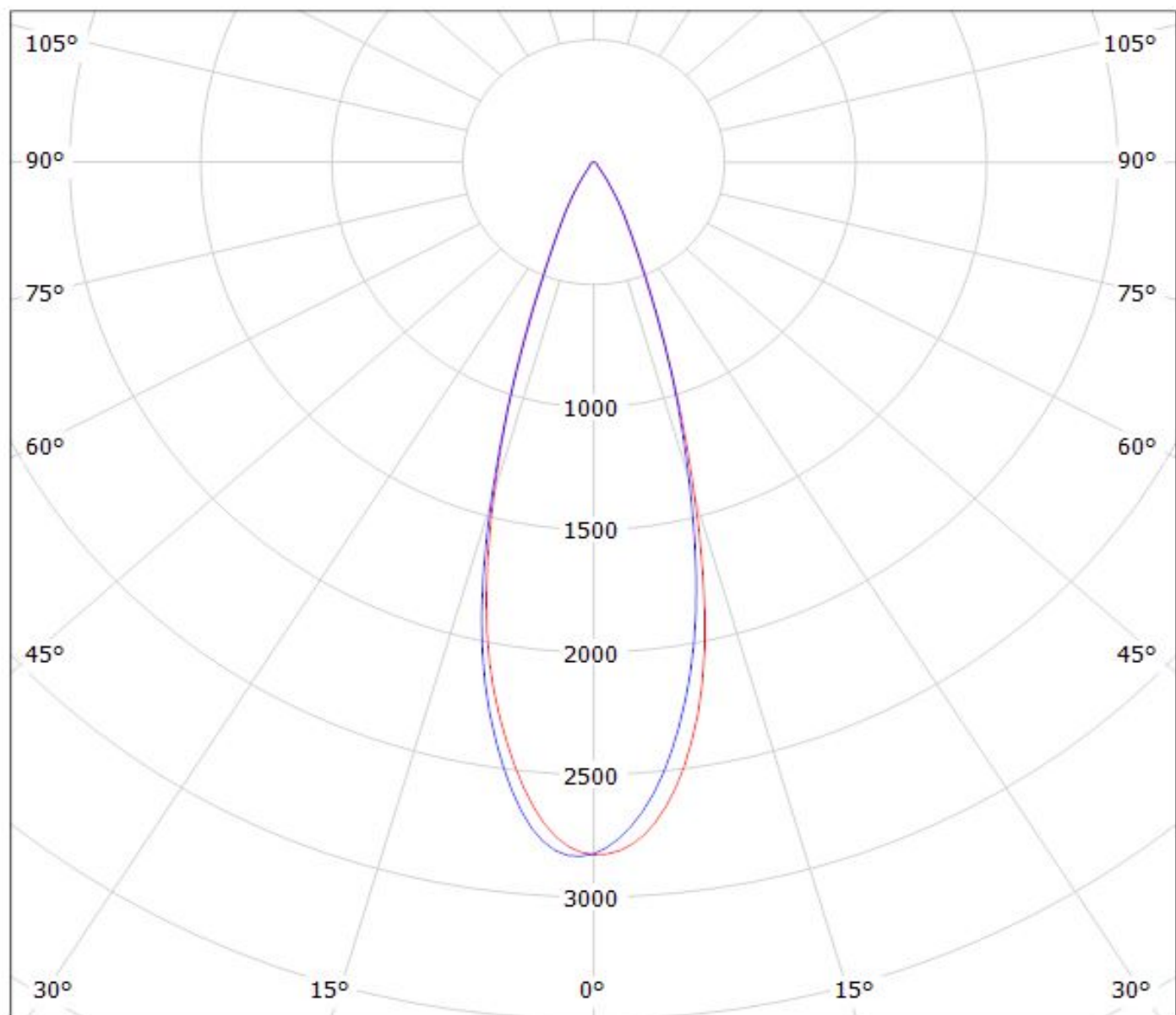

cd/klm

— C0 - C180

— C90 - C270

$\eta = 94\%$

Luminaire: LEDiL Oy C13233\_HB-2X2-M\_(LH351Z) Eff.93.0%

Lamps: 1 x SAMSUNG\_LH351Z\_2x2\_359.49lm@250mA\_P=2.86371W\_I=249.8mA

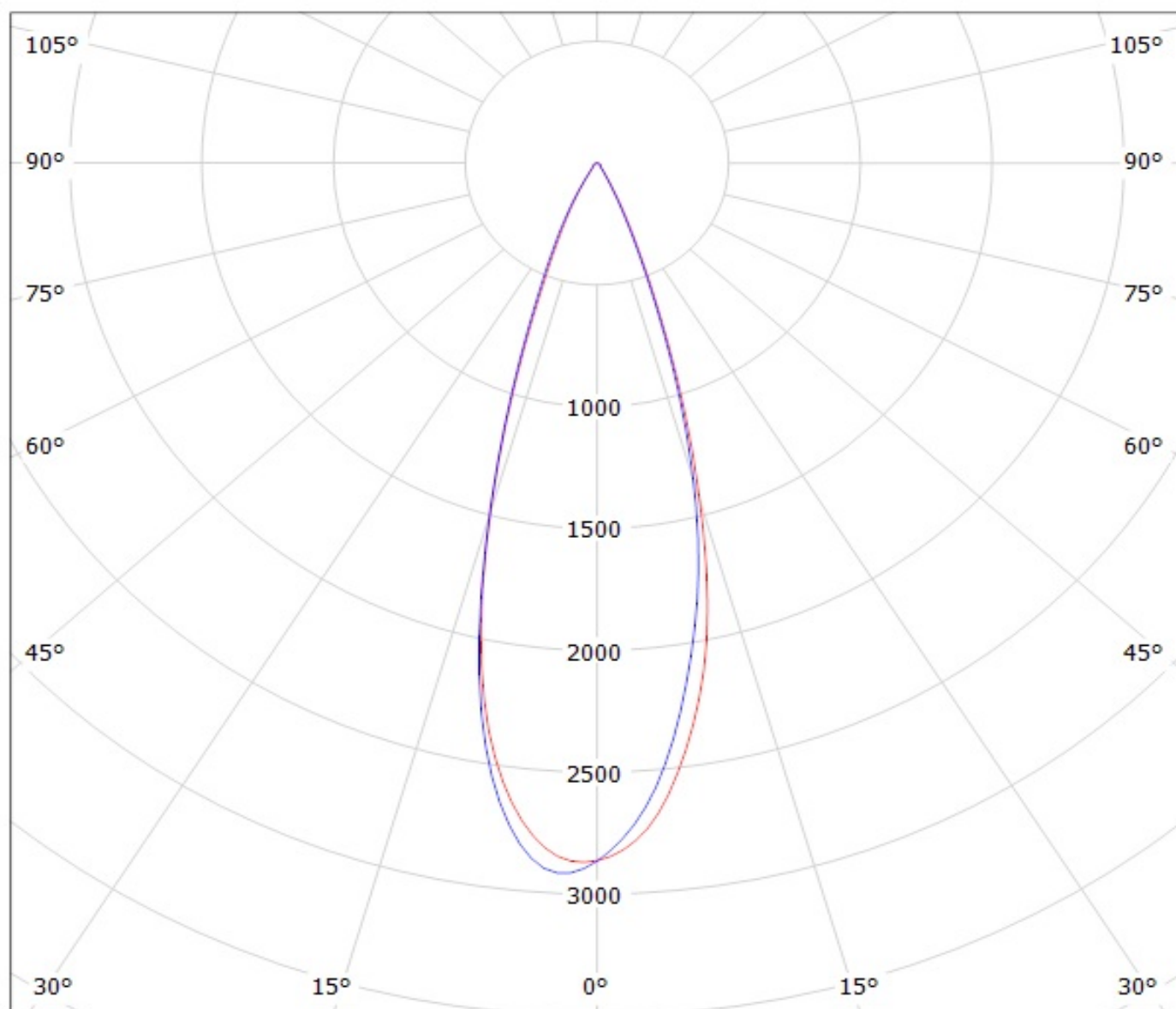

cd/klm

— C0 - C180

— C90 - C270



Luminaire: Ledil Oy C13233\_HB-2x2-M (Cree XP-G2 420lm @ 250mA) Efficiency=93%  
Lamps: 1 x Cree XP-G2 420lm @ 250mA

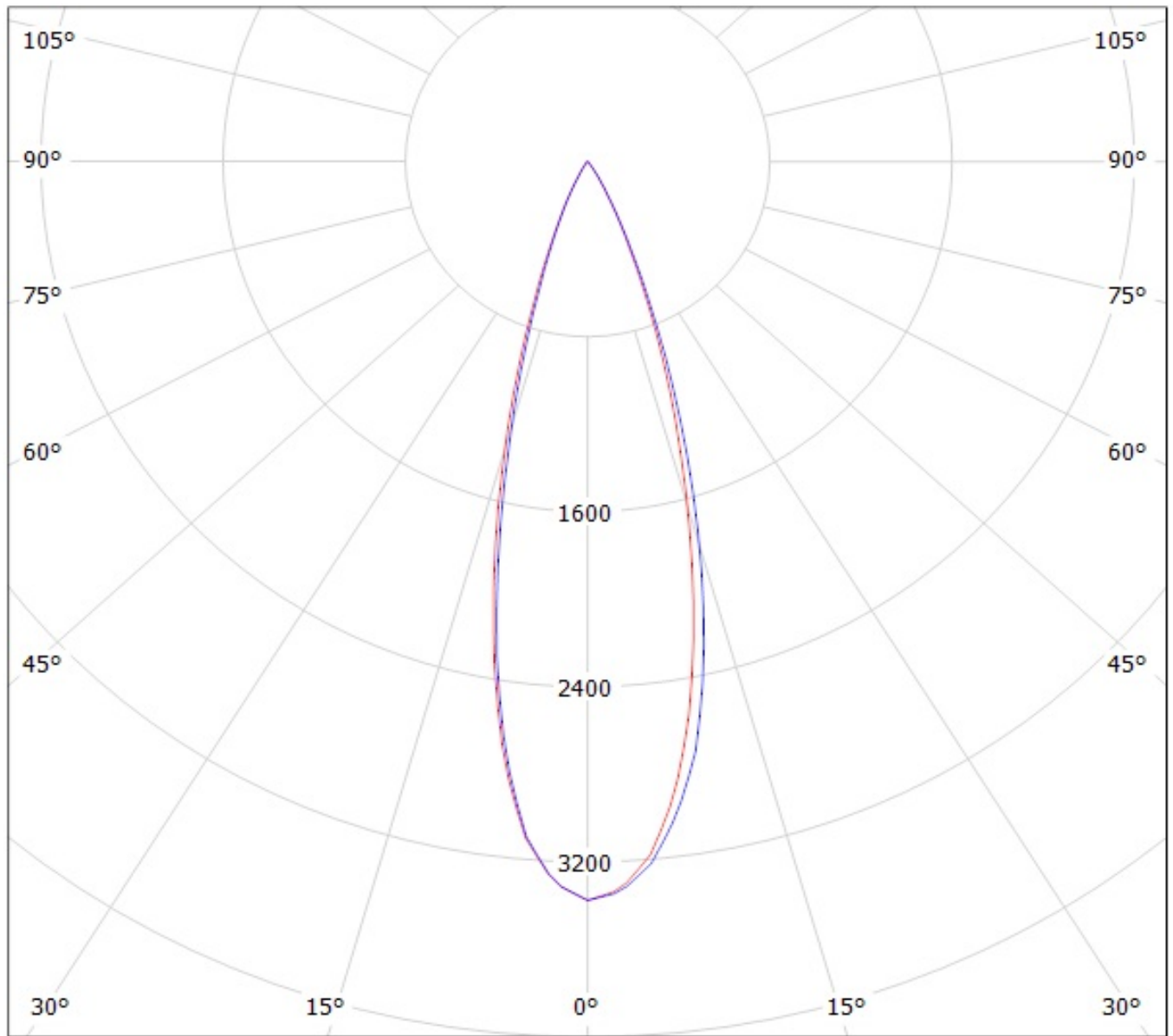

cd/klm

— C0 - C180

— C90 - C270



**NOTE: The typical divergence will be changed by different color, chip size and chip position tolerance. The typical total divergence is the full angle measured where the luminous intensity is half of the peak value.**