

Data Sheet

LL01CIOTxxR2-P

CITIZEN
Micro HumanTech



CL-L030



■ Features & Typical Applications

- High efficiency
- Available in 3 beam Patterns
- Optimized for uniform effects
- Decorative Light
- Architectural Lighting

■ Table of Contents

| | |
|---|-----|
| General Information & Product Nomenclature..... | P.2 |
| Optical Specifications | P.3 |
| Mechanical Specifications | P.4 |

LL01CIOTxxR2-P

General Information

- Reflector Material Flammability Rating PC
- Surface Coating Material Aluminum Mirror
- Operating Temperature range -40°C~+110°C(upper limit +120°C)
- Storage Temperature range -40°C~+110°C(upper limit +120°C)
- Usage and Maintenance:
 1. If necessary, clean reflectors with mild soap, water and soft cloth.
 2. Never use any commercial cleaning solvents on reflectors, like alcohol.
 3. Please handle or install reflectors with wearing gloves, skin oils may damage reflector or its optical characteristic.

Product Nomenclature

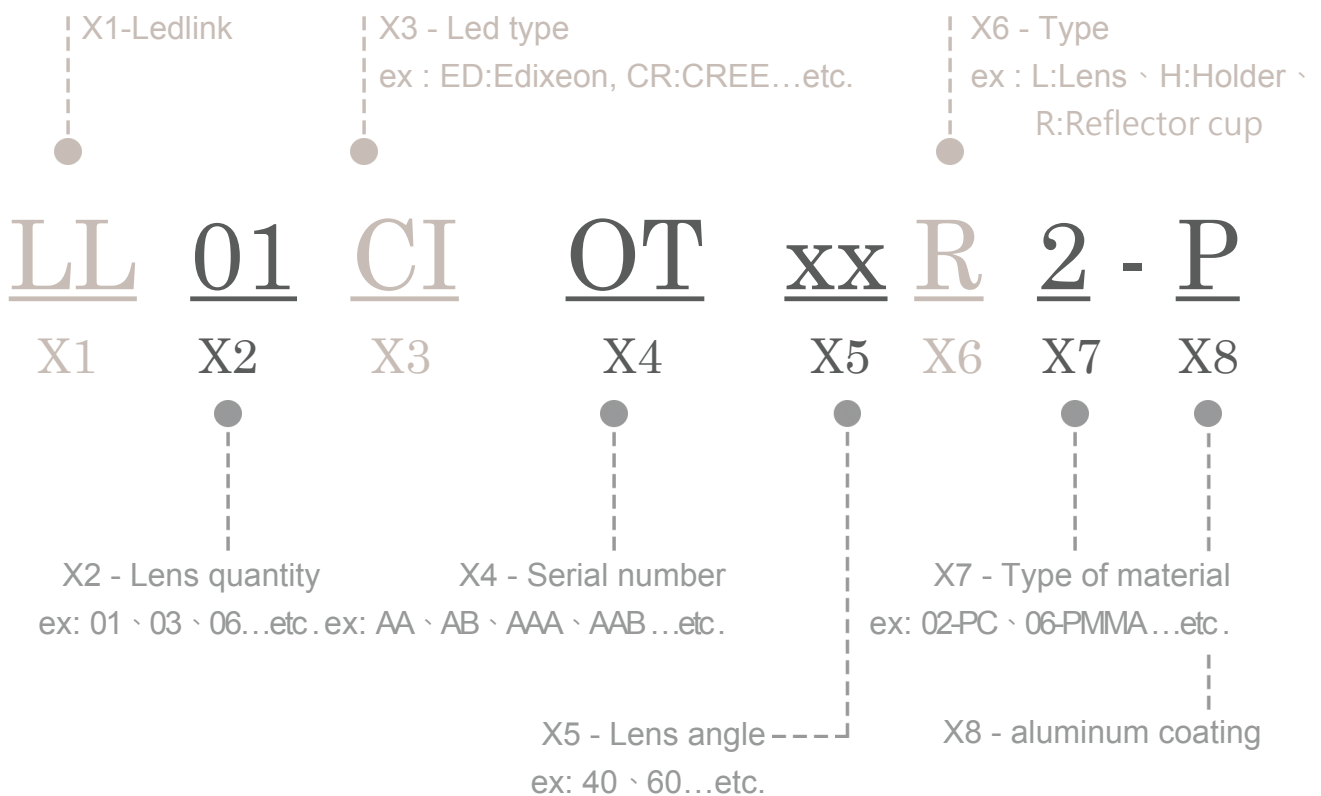



LL01CIOTxxR2-P

Optical Specifications

CITIZEN
 Micro Human Tech

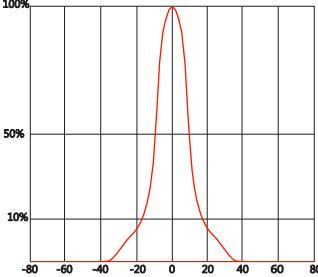
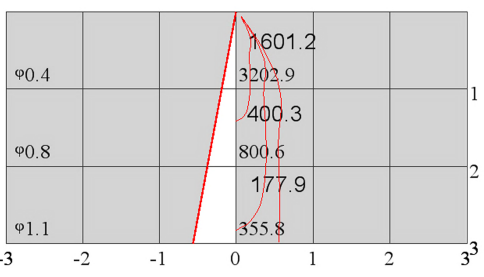
 Note: (1) degree: tolerance $\pm 2^\circ$
 (2) optical value: tolerance $\pm 10\%$

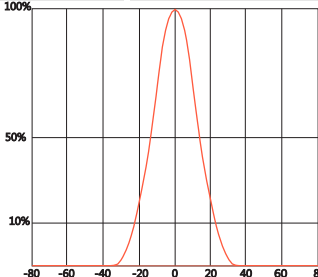
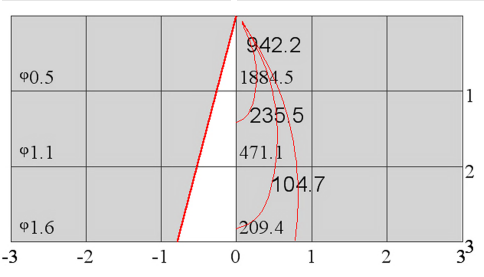
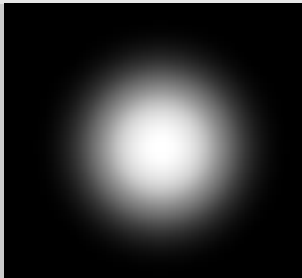
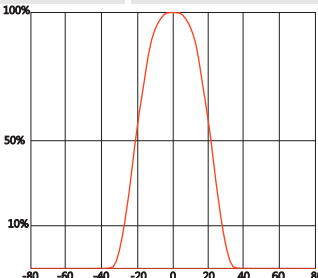
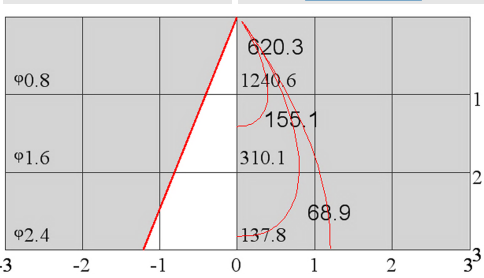
| Part Number | FWHM | Field Angle* | cd / lm | IES File |
|---|---|--|---------|--------------------------|
| LL01CIOT20R2-P | 22° | 53° | 4.4 | Download |
|  |  |  | | |
| Beam Pattern | Light Distribution Curve | Illuminance Distribution | | |
| LL01CIOT33R2-P | 31° | 57° | 3.1 | Download |
|  |  |  | | |
| Beam Pattern | Light Distribution Curve | Illuminance Distribution | | |
| LL01CIOT45R2-P | 48° | 66° | 1.8 | Download |
|  |  |  | | |
| Beam Pattern | Light Distribution Curve | Illuminance Distribution | | |

*The Field Angle is the angle between the two directions opposed to each other over the beam axis for which the luminous intensity is 10% that of the maximum luminous intensity.
 *This testing result is obtained through testing the popular rank LED samples which provided by the original manufacturer. Hence, the testing results would be varied as the users choose same LED model but different rank.

LL01CIOTxxR2-P

Mechanical Specification

1. Fixing method

- Glue
 Screw
 Tape
 Fixing-ring
 Frame

Note: (1) All dimensions are in mm.
 (2) All measurements are ± 0.15 mm unless otherwise indicated.

2. Lens dimensions

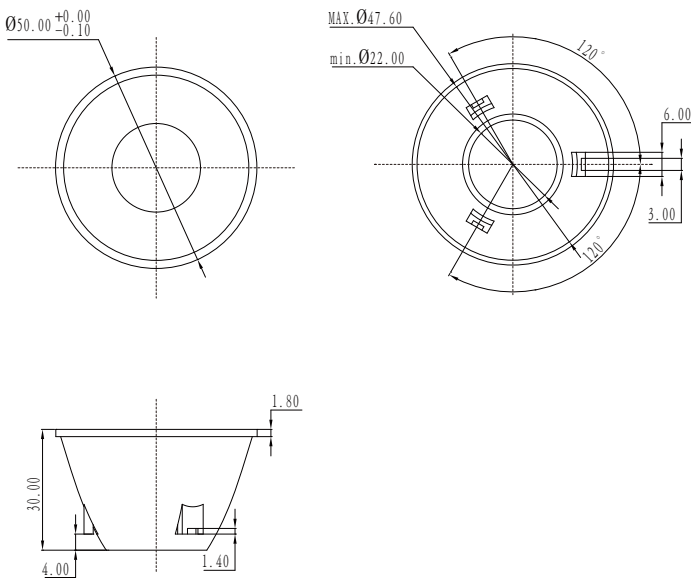

4. Lens assembly dimensions

3. Lens + Leds + MCPCB assembly instruction



5. View assembly lens with MCPCB:

