



Your Reliable Power Partner
Standard Switching Power Supply Manufacturer

September
2021



■AC/DC Enclosed

LRS Series	LRS-35, LRS-50, LRS-75, LRS-100	1	
	LRS-150F, LRS-150, LRS-200, LRS-350	2	
G3 Series	RS-15 / 25 / 35 / 50 / 75 / 100 / 150	3~4	
	RD-35 / 50 / 65 / 85 / 125		
	RID-50 / 65 / 85 / 125, RT-50 / 65 / 85 / 125		
	RQ-50 / 65 / 85 / 125		
SE Series	SE-450, SE-600, SE-1000, SE-1500	5	
PFC	General	PSP-600, PSPA-1000	6
		RSP-75, RSP-100, RSP-150, RSP-200	7
		RSP-320, RSP-500	8
		QP-150/200/320, LDPC LRS-450/600	9~10
		HRP-75, HRP-100, HRP[G]-150	11
		HRP[G]-200 / 300 / 450	12
		HRP[G]-600, HRPG-1000	13
		HRP-150N / 300N / 600N	14
		RSP-750, RSP-1000, RSP-1600, RSP-2000	15
		RSP-1500, RSP-2400, RSP-3000	16
	CSP-3000	17	
	RST-5000, RST-7K5	18	
	RST-10000, RST-15K	19	
	SHP-10K	20	
	Conduction Cooled	UHP-200, UHP-350, UHP-500	21
		UHP-750, UHP-1000	22
		UHP-1500, UHP-1500-HV, UHP-2500	23
	Digitalized	DPU-3200, PHP-3500, PHP-3500-HV	24
	DC House	NHDD-40	25~26
	Programmable	SPV-150, SPV-300 Output Voltage Programmable	27
Redundancy Module	ERDN20, ERDN40	28	
Medical	MSP-100, MSP-200, MSP-300	29	
	MSP-450, MSP-600, MSP-1000	30	

■DIN Rail Type

DIN Series	MDR-10 / 20 / 40 / 60 / 100	31
	HDR-15, HDR-30, HDR-60	32
	HDR-100, HDR-150	33
	SDR-75 / 120 / 240 / 480 [P] / 960	34
	NDR-75, NDR-120, NDR-240, NDR-480	35
	EDR-75, EDR-120, EDR-150	36
	WDR-60, WDR-120, WDR-240, WDR-480	37
	TDR-240, TDR-480, TDR-960	38
	DRA-40, DRA-60	39
	DRDN20, DRDN40	40
	DBUF20, DBUF40	41
	DUPS20, DUPS40	42
	DR-UPS40	43
	ICL-16R, ICL-16L, ICL-28R, ICL-28L	44

■AC/DC Open Frame

Industrial	LPS-50 / 75 / 100, LPP-100 / 150	45
	PS-05, PD-25, PD-45/65, PT-45/65, PT-6503	46
	RPD-65, RPT-65, PPT-125, PID-250	47
	EPS-15, EPS-25/35, EPS-45S, EPS-65S	48
	EPS-45 / 65-x [C] / EPS-120, EPP-120S	49
	ELP-75, EPP-100, EPP-150, EPP-200	50
	EPP-300, EPP-400, EPP-500	51
	IRM-01-x[S] / 02-x[S] / 03-x[S] / 05 / 10 / 15 / 20	52
	IRM-30 / 45 / 60 / 90 -x [ST]	53

Medical	MPM-05/10/15/20/30-x [ST]	54
	MPM-45 / 65 / 90-x [ST]	55
	MFM-05 / 10 / 15 / 20 / 30	56
	RPS-30, RPS-45, RPS-65, RPS-120S	57
	RPS/D/T-60, RPS-120/200, RPS-120 / 200-x [C]	58
	RPS/D/T-75, RPS[G]/T-160, RPT-160-C	59
	RPS-300/400, RPS-300/400-x [C],	60
	RPS-400-x [TF] / [SF]	
	RPS-500-x [C] / -x [TF] / -x [SF], MPQ-200	61

■AC/DC External Adaptor

Adaptor	Industrial	GST18A/B/E/U, GST25A/B/E/U, GST36B/E/U	62
		GST40A / 60A / 90A / 120A	63
		GST160A / 220A / 280A / 360A	64
		GS05E/U-USB, GS06E/U, GS15A/B/E/U	65
		SGAS06U/E, SGAS15A/B/U/E, SGAS60E/U	66
		SGA12E/U, SGA18E/U , SGA25E/U	67
		SGA40E/U/CH, SGA60E/U	68
		GE12/18/24/30/GE40 Interchangeable AC Plug	69
		GP25A, GP25B, GP50A	70
		OWA-60E/U, OWA-90E/U	71
	Moistureproof	OWA-120E/U, OWA-200E/U	72
		Changeable DC Plug Converter Selection Guide	73
	Medical	GSM06/12 E/U, GSM18/25B/E/U	74
		GSM36B/E/U, GSM60E/U, GSM40/60A/B	75
		GSM90A/B, GSM120A/B	76
		GSM160A/B, GSM220A/B	77
		GEM06I , GEM12I, GEM18I	78
		GEM30I / 40I / 60I Interchangeable AC Plug 2	79

■Configurable Power

Modular Series	UMP-400	80
	NMP650, NMP1K2	81~82
	NMS-240, NMD-240	
	MP450, MP650, MP1K0	83~84
	MS-75 / 150 / 210 / 300 / 360, MD-100	
	RCP-1000, RCP-1U, RCP-1600, RHP-1U	85
	RCP-2000, RKP-1U [], RKP-CMU1,	86
	RKP-1U [] - CMU1	
	DRP-3200, DHP-1UT-A, CMU2 [] -R1	87

■Battery Charger

Stationary	Portable	GC30B/E/U, GC120, GC160, GC220, GC330	88
	ENP/ENC-120 / 180 / 240 / 360	89	
	PA-120, PB-120	90	
	PB-300/360/600/1000	91	
	NPB-120/240/360	92	
	NPB-450/750/1200/1700	93	
	NPP-450/750/1200/1700 NPP vs. NPP	94	
	RPB-1600, RCB-1600	95	
	DBU-3200, DBR-3200, DHP-1UT	96	
	SBP-001 Smart Programmer Connection	97	
	HEP-600C, BIC-2200	98	

■DC/AC Inverter

True Sine	NTS-250P / 400P AC Socket Type	99
	NTS-300 / 450 / 750	100
	NTS-1200 / 1700 / 2200 / 3200	101
	NTU-1200 / 1700 / 2200 / 3200	102
	TS-200 / 400 / 700 / 1000 / 1500 / 3000	103
	TN-1500, TN-3000	104
	Modified Sine	A301, A302

■ Specific Purpose

Harsh Environment	HEP-100, HEP-150, HEP-185	106	
	HEP-240, HEP-320, HEP-480	107	
	HEP-600, HEP-1000, HEP-1000-W	108	
Security	DRS-240, DRS-480	109	
	DRC-40, DRC-60	110	
	DRC-100, DRC-180	111	
	PSC-35-x-C, PSC-60-x-C, PSC-100-x-C, PSC-160-x-C	112	
	ADS-55, AD-55, ADD-55, ADS-155, AD-155, ADD-155	113	
	SCP-35, SCP-50, SCP-75	114	
KNX	Power	KNX-20E, KNX-40E	115
	Actuator	KAA-8R, KAA-4R4V	116
LED Sign Panel	LSP-160, UHP-200A	117	
Rainproof	ERP-200, ERP-350, ERPF-400	118	

■ DC/DC Converter

DIN Rail	DDRH-60	119		
	DDR-15, DDR-30, DDR-60	120		
	DDR-120, DDR-240, DDR-480	121		
	RSD-30, RSD-60, RSD-100, RSD-150	122		
Enclosed	RSD-200, RSD-300, RSD-500	123		
	SD-15, SD-25, SD-50, SD-100	124		
	SD-150/200/350/500/1000	125		
On Board	Railway	DIP	RSDW08, RDDW08, RSDW10, RDDW10	126
		2"x1"	RSDW20, RDDW20, RSDW20UW, RDDW20UW RSDW40, RDDW40, RSDW60, RDDW60	127 128
	Medical	SIP	MDS01, MDD01, MDS02, MDD02	129
		DIP	MDS03, MDD03, MDS06, MDD06	130
		2"x1"	MDS15, MDS20	131
	Industrial	SMD	SPOL-01, SPOL-12P, SPOL-12N	132
			N78-PV/PH/C/CW	133
			SMT01, SBTN01, SFTN01 DETNO1, SFTN02, DETN02	134 135
		SIP	SMU01, SMU02, SPU01, DPU01	136
			SPUN02, DPUN02, SPU03	137
			SPRN01, DPRN01, SPA01	138
			SPAN02, DPAN02, SPB09, DPB09 SPBW03, DPBW03, SPBW06, DPBW06	139 140
DIP		SRS, SUS01, SMA01	141	
		SLC03, DLC03, SCWN03, DCWN03 SCWN06, DCWN06, SCW08, DCW08 SCW12, DCW12, SCW20	142 143 144	
		SKMW06, DKMW06, SKM10, DKM10 SKMW15, DKMW15, SKMW20, DKMW20 SKMW30, DKMW30	145 146 147	
2"x1"	SLW05, DLW05, SKE10, DKE10	148		
	SKA15, DKA15 SKA20, SKM30, SKM50	149 150		
2"x2"	SKE15, DKE15	151		
	SDM30, DKA30, TKA30 SKA40, SKA60	152 153		
Brick	MHB75, MHB100, MHB150	154		
Others	NSD05/10-S, NSD10-D, NSD15-S/D NID35, NID65, NID100	155 156		
Open Frame	PSD-15, PSD-30, PSD-45	157		

■ Accessories

Accessories	DRL-01 / 02 / 03A, DRP-01 / 01A / 02 / 03 / 04	158
	MHS012 / 013 / 014 / 025 / 026 / 027	
	TBC-05 / 07 / 08 / 09, DH12A40V	

	: New Announced		: Coming Soon
	: New Product within 2 Years		: Supplementary Information
	: Not Recommended for New Design		
	: The Premium Series		
	: The Best Cost-Performance Series		

Type	Series	Model No.	Page
AC/DC Enclosed	PFC / General	PSPA-1000	6
		HRP all models	11~12
		HRP(G)-600, HRP(G)-1000	13
	Programmable	DPU-3200	24
	Medical	MSP all models	29~30
DIN		SDR-75 / 120 / 240 / 480 [P] / 960	34
		WDR-60 / 120 / 240 / 480	37
AC/DC External Adaptor	Adaptor	OWA all models	71~72
Configurable Power	Modular	NMP-650 / 1K2	81~82
19" Rack Power	1U Front End	DRP-3200	87
DC/DC Converter	Enclosed	RSD all models	122~123

Type	Series	Model No.	Page	
AC/DC Enclosed	LRS	All models	1~2	
	G3	RS/RD/RT/RQ all models	3	
	SE	SE-1000 / 1500	5	
	PFC / General		PSP-600	6
			RSP-75 / 100 / 150 / 200 / 320 / 500	7~8
			RSP-750 / 1000 / 1600 / 2000	15
	PFC / Programmable		RSP-2400 / 3000	16
			RST-5000 / 10000	18
	PFC / U-bracket		RST-10000 / 15K	19
			UHP-200 / 350 / 500	21
	DIN		UHP-750 / 1000 / 1500 / 2500	22~23
			MDR-10 / 20 / 40 / 60 / 100	31
			HDR-15 / 30 / 60 / 100 / 150	32~33
			NDR-75 / 120 / 240 / 480	35
			EDR-75 / 120 / 150	36
TDR-240 / 480 / 960			38	
DRA-40 / 60			39	
AC/DC Open Frame	Industrial	EPS-15 / 25 / 35 / 45 / 45S / 65 / 65S / 120	48~49	
		EPP all models	50~51	
		IRM all models	52~53	
	Medical		MPM all models	54~55
			MFM-05 / 10 / 15 / 20 / 30	56
			RPS-30/45/65, RPS-60/65 RPS-120/120S/200-x [C]	57~58
RPS/D/T-75, RPS/T-160, RPT-160-C	59			
RPS-300 / 400 / 500 -x [C]	60~61			
AC/DC External Adaptor	Industrial	GST all models	62~64	
Battery Charger	Stationary	SGAS06 / 15 / 60	66	
		ENP/ENC-120 / 180 / 240 / 360	89	
		RCB-1600	95	
Security Power Solution	Security	DBR-3200	96	
		PSC-35 / 60 / 100 / 160 x-C	112	
DC/DC Converter	DIN	DDRH-60 DDR-15 / 30 / 60 / 120 / 240 / 480	119~121	



LRS-100

LRS-75

LRS-35/50

Features

- No load power consumption <0.2W for 35W/50W; <0.3W for 75W/100W
- Universal AC input / Full range
- Withstand 300VAC surge input for 5 seconds
- Ultra compact and 1U low profile
- Withstand 5G vibration test
- High operating temperature up to 70°C
- Protections: Short circuit / Overload / Over voltage
- Cooling by free air convection
- Compliance to IEC/EN60335-1(PD3) and IEC/EN61558-1,-2-16 for household appliances
- Operating altitude up to 5000 meters
- High efficiency, long life and high reliability
- LED indicator for power on
- Low cost
- 3 years warranty

General Specification



Model No.	LRS-35	LRS-50	LRS-75	LRS-100
AC input voltage range	85~264VAC ; 120~370VDC			
AC inrush current (max.)	Cold start, 45A at 230VAC		65A at 230VAC	50A at 230VAC
DC adjustment range	±10% by potentiometer			
Overload protection	Range	110%~150%		
	Type	Hiccup mode, auto-recovery		
Over voltage protection	Range	115%~135% rated output voltage		
	Type	Shut down o/p voltage, re-power on to recover		
Withstand voltage	I/P-O/P: 4kVAC, I/P-FG: 2kVAC, O/P-FG: 1.25kVAC, 1 minute			
Working temperature	-30~+70°C (refer to output derating curve)			
Safety standards	UL62368-1, BS EN/EN62368-1, BS EN/EN61558-1, EN61558-2-16, BS EN/EN60335-1, CCC GB4943, BIS IS13252, BSMI CNS14336-1, EAC TP TC 004, AS/NZS 60950.1 KC K60950-1(12/24V only)approved			
EMC standards	BS EN/EN55032 class B, EN55014, EN61000-3-2, 3, EN61000-4,2,3,4,5,6,8,11 ; GB9254 ; CNS13438			
Connection	5P/9.5mm pitch terminal block			7P/9.5mm pitch terminal block
Dimension (LxWxH) (mm)	99x 82x 30		99x 97x 30	129x 97x 30

35W

LRS-35

Model No.	Output	Tol.	R&N	Effi.
LRS-35-5	5V, 0~7A	±2%	80mV	82.0%
LRS-35-12	12V, 0~3A	±1%	120mV	86.0%
LRS-35-15	15V, 0~2.4A	±1%	120mV	86.0%
LRS-35-24	24V, 0~1.5A	±1%	150mV	88.0%
LRS-35-36	36V, 0~1A	±1%	200mV	88.0%
LRS-35-48	48V, 0~0.8A	±1%	200mV	89.0%

75W

LRS-75

Model No.	Output	Tol.	R&N	Effi.
LRS-75-5	5V, 0~14A	±2%	100mV	86.5%
LRS-75-12	12V, 0~6A	±1%	120mV	89.0%
LRS-75-15	15V, 0~5A	±1%	120mV	89.0%
LRS-75-24	24V, 0~3.2A	±1%	150mV	90.0%
LRS-75-36	36V, 0~2.1A	±1%	200mV	91.5%
LRS-75-48	48V, 0~1.6A	±1%	200mV	91.5%

50W

LRS-50

Model No.	Output	Tol.	R&N	Effi.
LRS-50-3.3	3.3V, 0~10A	±3%	80mV	80.0%
LRS-50-5	5V, 0~10A	±2%	80mV	83.0%
LRS-50-12	12V, 0~4.2A	±1%	120mV	86.0%
LRS-50-15	15V, 0~3.4A	±1%	120mV	88.0%
LRS-50-24	24V, 0~2.2A	±1%	150mV	88.0%
LRS-50-36	36V, 0~1.45A	±1%	200mV	89.0%
LRS-50-48	48V, 0~1.1A	±1%	200mV	90.0%

100W

LRS-100

Model No.	Output	Tol.	R&N	Effi.
LRS-100-3.3	3.3V, 0~20A	±3%	100mV	84.5%
LRS-100-5	5V, 0~18A	±2%	100mV	86.0%
LRS-100-12	12V, 0~8.5A	±1%	120mV	88.0%
LRS-100-15	15V, 0~7A	±1%	120mV	88.5%
LRS-100-24	24V, 0~4.5A	±1%	150mV	90.0%
LRS-100-36	36V, 0~2.8A	±1%	200mV	90.5%
LRS-100-48	48V, 0~2.3A	±1%	200mV	91.0%

Enclosed-LRS Series 150~350W Low Profile



Features

- No load power consumption <0.5W for 150W; <0.75W for 200W/350W
- AC input selectable by switch (LRS-150F Universal AC input / Full range)
- Withstand 300VAC surge input for 5 seconds
- Ultra compact and 1U low profile
- Withstand 5G vibration test
- High operating temperature up to 70°C
- Protections: Short circuit / Overload / Over voltage / Over temp.
- Cooling by free air convection (150W/200W); forced air cooling by built-in DC fan (350W)
- Compliance to IEC/EN60335-1(PD3) and IEC/EN61558-1,-2-16 for household appliances (150W)
- Operating altitude up to 5000 meters
- LED indicator for power on
- High efficiency, long life and high reliability
- Low cost
- 3 years warranty

General Specification (Please refer to www.meanwell.com for detail spec.)

Model No.	LRS-150F	LRS-150	LRS-200	LRS-350
AC input voltage range	85~264VAC; 120~370VDC	115 / 230VAC by switch		
AC inrush current (max.)	Cold start, 60A at 230VAC			
DC adjustment range	±10% by potentiometer			
Overload protection	Range	110%~140%		
	Type	Hiccup mode, auto-recovery		
Over voltage protection	Range	115%~145% rated output voltage		
	Type	Shut down o/p voltage, re-power on to recover		
Withstand voltage	I/P-O/P: 4kVAC, I/P-FG: 2kVAC, O/P-FG: 1.25kVAC		I/P-O/P: 3kVAC, I/P-FG: 2kVAC, O/P-FG: 0.5kVAC	
Working temperature	-30~+70°C (refer to output derating curve)		-25~+70°C (refer to output derating curve)	
Safety standards	UL62368-1, BS EN/EN62368-1, BS EN/EN61558-1, EN61558-2-16, BS EN/EN60335-1, CCC GB4943, BSMI CNS14336-1, EAC TP TC 004, AS/NZS60950.1 BIS IS13252(LRS-150), KC K60950-1(LRS-150-12 only) approved		UL62368-1, BSMI CNS14336-1, EAC TP TC 004, BIS IS13252, KC K60950-1(12/24V only) approved	
EMC standards	BS EN/ EN55032 class B, EN55014, EN61000-3-2(120W), 3, EN61000-4, 2,3,4,5,6,8,11, GB/T 9254, EAC TP TC 020, BSMI CNS13438		EAC TP TC 020, BSMI CNS13438, Design refer to EN55032 class A	
Connection	7P/9.5mm pitch terminal block		9P/9.5mm pitch terminal block	
Dimension (LxWxH) (mm)	159x 97x 30		215x 115x 30	

LRS-150 Series (12V/24V only)

Model No.	Output	Tol.	R&N	Effi.
LRS-150-12	12V, 0~12.5A	±1%	150mV	87.5%
LRS-150-15	15V, 0~10A	±1%	150mV	88.5%
LRS-150-24	24V, 0~6.5A	±1%	200mV	89.0%
LRS-150-36	36V, 0~4.3A	±1%	200mV	89.0%
LRS-150-48	48V, 0~3.3A	±1%	200mV	90.0%

LRS-200 Series (12V, 24V only)

Model No.	Output	Tol.	R&N	Effi.
LRS-200-3.3	3.3V, 0~40A	±3%	150mV	83.0%
LRS-200-4.2	4.2V, 0~40A	±4%	150mV	86.0%
LRS-200-5	5V, 0~40A	±3%	150mV	87.0%
LRS-200-12	12V, 0~17A	±1.5%	150mV	87.5%
LRS-200-15	15V, 0~14A	±1%	150mV	88.0%
LRS-200-24	24V, 0~8.8A	±1%	150mV	89.5%
LRS-200-36	36V, 0~5.9A	±1%	200mV	89.5%
LRS-200-48	48V, 0~4.4A	±1%	200mV	90.0%

LRS-150F Series

Model No.	Output	Tol.	R&N	Effi.
LRS-150F-5	5V, 0~22A	±2%	100mV	85.0%
LRS-150F-12	12V, 0~12.5A	±1%	150mV	87.5%
LRS-150F-15	15V, 0~10A	±1%	150mV	89.0%
LRS-150F-24	24V, 0~6.5A	±1%	200mV	89.0%
LRS-150F-36	36V, 0~4.3A	±1%	200mV	89.0%
LRS-150F-48	48V, 0~3.3A	±1%	200mV	90.0%

LRS-350 Series (12V, 24V only)

Model No.	Output	Tol.	R&N	Effi.
LRS-350-3.3	3.3V, 0~60A	±4%	150mV	79.5%
LRS-350-4.2	4.2V, 0~60A	±4%	150mV	81.5%
LRS-350-5	5V, 0~60A	±3%	150mV	83.5%
LRS-350-12	12V, 0~29A	±1.5%	150mV	85.0%
LRS-350-15	15V, 0~23.2A	±1%	150mV	86.0%
LRS-350-24	24V, 0~14.6A	±1%	150mV	88.0%
LRS-350-36	36V, 0~9.7A	±1%	200mV	88.5%
LRS-350-48	48V, 0~7.3A	±1%	200mV	89.0%

Enclosed-G3 Series

High Reliability Compact



RS-150 RD/ID/T/Q-125 RS-100 RD/ID/T/Q-85 RS-75 RD/ID/T/Q-65 RS-50 RD/ID/T/Q-50 RS-35 RD-35 RS-25 RS-15

Features

- No load power consumption <0.5W (RS-15~75)
- All using 105°C long life electrolytic capacitors
- Protections: Short circuit / Overload / Over voltage / Over Temp.(RS-15)
- Meet EMS EN50082-2/EN61000-6-2 heavy industry level (35~150W)
- Withstand 300VAC surge input for 5 sec.
- High operating temperature up to 70°C
- Withstand 5G vibration test
- Miniature size
- Long life and high reliability
- LED indicator for power on
- Suitable for critical applications
- 3 years warranty

General Specification (Please refer to www.meanwell.com for detail spec.)



Model No.	RS-15	RS-25	RS-35 RD-35	RS-50 RD / ID / T / Q-50	RS-75 RD / ID / T / Q-65	RS-100 RD / ID / T / Q-85	RS-150 RD / ID / T / Q-125	
AC input voltage range	85~264VAC, 120~370VDC	88~264VAC, 125~373VDC					115 / 230VAC by switch	
AC inrush current (max.)	Cold start, 65A at 230VAC	30A at 230VAC	36A at 230VAC (RS-35) 45A at 230VAC (RD-35)	33A at 230VAC 48A at 230VAC (RD-50)	40A at 230VAC			
DC adjustment range	±10% by potentiometer for single output; CH1 -5%~+10% by potentiometer for multiple output							
Overload protection	>105%, hiccup mode	110%~180%	110%~150% hiccup mode, auto-recovery (150% ~190% for RID-125-1205/2405)					
Over voltage protection	115%~135%, shut off		115%~135% rated output voltage, hiccup mode, auto-recovery					
Withstand voltage	I/P - O/P: 3kVAC, I/P - FG: 2kVAC, O/P - FG: 0.5kVAC, 1 minute							
Working temperature	-20~+70°C		-25~+70°C (refer to the derating curve for different models)					
Vibration	10~500Hz, 5G 10min. /1 cycle, period for 60 min. each along X, Y, Z axes							
Safety standards	UL62368-1, TUV BS EN/EN62368-1, CCC GB4943(RS-15, 25, 50 only), EAC TP TC 004, BSMI CNS14336-1(RS-15/25, RD,RT, RQ only) BIS IS 13252(RS-15/25 only)approved							
EMC standards	BS EN/EN55032 class B, EN61000-3-2,3, EN61000-4-2,3,4,5,6,8,11, EN61000-6-2 (EN50082-2) (35~150W); GB17625.1, EAC TP TC 020; GB9254 for RS-15, 25, 50 only							
Connection	Terminal block for input and output							
Dimension (LxWxH)(mm)	62.5x 51x 28	78x 51x 28	99x 82x 36	99x 97x 36	129x 98x 38	159x 97x 38	199x 98x 38	

15W – Single Output

Model No.	Output	Tol.	R&N	Effi.
RS-15-3.3	3.3V, 0~3.0A	±3%	80mV	72%
RS-15-5	5V, 0~3.0A	±2%	80mV	77%
RS-15-12	12V, 0~1.3A	±1%	120mV	81%
RS-15-15	15V, 0~1.0A	±1%	120mV	81%
RS-15-24	24V, 0~0.625A	±1%	200mV	82%
RS-15-48	48V, 0~0.313A	±1%	200mV	82%

RS-50-15	15V, 0~3.4A	±1%	120mV	86.0%
RS-50-24	24V, 0~2.2A	±1%	120mV	88.0%
RS-50-48	48V, 0~1.1A	±1%	200mV	89.0%

25W – Single Output

Model No.	Output	Tol.	R&N	Effi.
RS-25-3.3	3.3V, 0~6.0A	±3%	80mV	73.5%
RS-25-5	5V, 0~5.0A	±2%	80mV	78.5%
RS-25-12	12V, 0~2.1A	±1%	120mV	81.5%
RS-25-15	15V, 0~1.7A	±1%	120mV	83.5%
RS-25-24	24V, 0~1.1A	±1%	120mV	86.0%
RS-25-48	48V, 0~0.57A	±1%	200mV	85.0%

75W – Single Output

Model No.	Output	Tol.	R&N	Effi.
RS-75-3.3	3.3V, 0~15A	±3%	80mV	75.0%
RS-75-5	5V, 0~12A	±2%	80mV	79.0%
RS-75-12	12V, 0~6.0A	±1%	120mV	84.5%
RS-75-15	15V, 0~5.0A	±1%	120mV	86.0%
RS-75-24	24V, 0~3.2A	±1%	120mV	88.5%
RS-75-48	48V, 0~1.6A	±1%	200mV	89.5%

35W – Single Output

Model No.	Output	Tol.	R&N	Effi.
RS-35-3.3	3.3V, 0~7.0A	±3%	80mV	76.5%
RS-35-5	5V, 0~7.0A	±2%	80mV	80.5%
RS-35-12	12V, 0~3.0A	±1%	120mV	84.5%
RS-35-15	15V, 0~2.4A	±1%	120mV	86.0%
RS-35-24	24V, 0~1.5A	±1%	120mV	88.0%
RS-35-48	48V, 0~0.8A	±1%	200mV	88.5%

100W – Single Output

Model No.	Output	Tol.	R&N	Effi.
RS-100-3.3	3.3V, 0~20A	±3%	80mV	74%
RS-100-5	5V, 0~16A	±2%	80mV	77%
RS-100-12	12V, 0~8.5A	±1%	120mV	81%
RS-100-15	15V, 0~7.0A	±1%	120mV	82%
RS-100-24	24V, 0~4.5A	±1%	120mV	84%
RS-100-48	48V, 0~2.3A	±1%	200mV	84%

50W – Single Output

Model No.	Output	Tol.	R&N	Effi.
RS-50-3.3	3.3V, 0~10A	±3%	80mV	78.0%
RS-50-5	5V, 0~10A	±2%	80mV	83.0%
RS-50-12	12V, 0~4.2A	±1%	120mV	84.5%

150W – Single Output

Model No.	Output	Tol.	R&N	Effi.
RS-150-3.3	3.3V, 0~30A	±3%	80mV	74%
RS-150-5	5V, 0~26A	±2%	80mV	78%
RS-150-12	12V, 0~12.5A	±1%	120mV	83%
RS-150-15	15V, 0~10A	±1%	120mV	84%
RS-150-24	24V, 0~6.5A	±1%	120mV	86%
RS-150-48	48V, 0~3.3A	±1%	200mV	86%

Enclosed-G3 Series



35W — Dual Output

Model No.	Output	Tol.	R&N	Effi.	Max.
RD-35A	5V, 0~4.0A	±2%	80mV	79%	32W
	12V, 0~1.0A	±6%	120mV		
RD-35B	5V, 0~4.0A	±2%	80mV	82%	35W
	24V, 0~1.3A	±5%	120mV		
RD-3513	13.5V, 0~2.0A	±4%	120mV	80%	35W
	-13.5V, 0~1.5A	±4%	120mV		

50W — Dual Output (Output isolated for RID-50A/B)

Model No.	Output	Tol.	R&N	Effi.	Max.
RD-50A	5V, 0~6.0A	±2%	80mV	79%	54W
	12V, 0~3.0A	±7%	120mV		
RD-50B	5V, 0~6.0A	±2%	80mV	80%	54W
	24V, 0~2.0A	±8%	120mV		

65W — Dual Output (Output isolated for RID-65A/B)

Model No.	Output	Tol.	R&N	Effi.	Max.
RD-65A	5V, 0~8.0A	±2%	80mV	78%	66W
	12V, 0~4.0A	±6%	120mV		
RD-65B	5V, 0~8.0A	±2%	80mV	77%	68W
	24V, 0~3.0A	+4%, -6%	150mV		

85W — Dual Output (Output isolated for RID-85A/B)

Model No.	Output	Tol.	R&N	Effi.	Max.
RD-85A	5V, 0~10A	±2%	80mV	78%	88W
	12V, 0~5.0A	±5%	120mV		
RD-85B	5V, 0~10A	±2%	80mV	80%	88W
	24V, 0~2.5A	±5%	120mV		

125W — Dual Output

Model No.	Output	Tol.	R&N	Effi.	Max.
RD-125A	5V, 0~15A	±5%	80mV	82%	131W
	12V, 0~10A	±7%	120mV		
RD-125B	5V, 0~10A	±5%	80mV	85%	133W
	24V, 0~5.0A	±7%	120mV		

125W — Dual Output (Output isolated for RID-125)

Model No.	Output	Tol.	R&N	Effi.	Max.
RD-125-1224	12V, 0~7.0A	±2%	120mV	85%	133W
	24V, 0~5.0A	+8%, -5%	200mV		
RD-125-2412	24V, 0~5.0A	±2%	200mV	85%	133W
	12V, 0~7.0A	±10%	120mV		
RD-125-1248	12V, 0~7.0A	±2%	120mV	86%	138W
	48V, 0~2.5A	+8%, -5%	240mV		
RD-125-4812	48V, 0~2.5A	±2%	240mV	86%	138W
	12V, 0~7.0A	±10%	120mV		
RD-125-2448	24V, 0~4.0A	±1%	200mV	86%	144W
	48V, 0~2.5A	±4%	240mV		
RD-125-4824	48V, 0~2.5A	±1%	240mV	86%	144W
	24V, 0~4.0A	±8%	240mV		
RID-125-1205	12V, 0~10.5A	±2%	120mV	80%	125W
	5V, 0~3.0A	±3%	80mV		
RID-125-2405	24V, 0~5.3A	±2%	120mV	83%	125W
	5V, 0~3.0A	±3%	80mV		

50W — Quad Output (RT-50 without -5V or -12V output)

Model No.	Output	Tol.	R&N	Effi.	Max.
RQ-50B	5V, 0~6.0A	±2%	80mV	74%	46W
	12V, 0~1.5A	±6%	120mV		
	-5V, 0~1.0A	±3%	100mV		
RQ-50C	-12V, 0~1.0A	±3%	80mV		
	5V, 0~6.0A	±2%	80mV	75%	50W
	15V, 0~1.5A	±6%	120mV		
RQ-50D	-5V, 0~1.0A	±3%	100mV		
	-15V, 0~1.0A	±3%	80mV		
	5V, 0~6.0A	±2%	80mV	79%	53W
	12V, 0~1.5A	±6%	120mV		
	24V, 0~1.0A	+7%, -5%	180mV		
	-12V, 0~1.0A	±3%	80mV		

65W — Quad Output (RT-65 without -5V or -12V output)

Model No.	Output	Tol.	R&N	Effi.	Max.
RQ-65B	5V, 0~8.0A	±2%	80mV	76%	63W
	12V, 0~3.0A	+9%, -5%	120mV		
	-5V, 0~1.0A	±5%	80mV		
RQ-65C	-12V, 0~1.0A	±5%	80mV		
	5V, 0~8.0A	±2%	80mV	76%	65W
	15V, 0~3.0A	+10%, -4%	120mV		
RQ-65D	-5V, 0~1.0A	±5%	80mV		
	-15V, 0~1.0A	±5%	80mV		
	5V, 0~8.0A	±2%	80mV	78%	68W
	12V, 0~3.0A	±6%	120mV		
	24V, 0~1.5A	±8%	180mV		
	-12V, 0~1.0A	±5%	80mV		

85W — Quad Output (RT-85 without -5V or -12V output)

Model No.	Output	Tol.	R&N	Effi.	Max.
RQ-85B	5V, 0~10A	±2%	80mV	76%	81W
	12V, 0~4.0A	+7%, -3%	120mV		
	-5V, 0~1.0A	±8%	100mV		
RQ-85C	-12V, 0~1.0A	±5%	80mV		
	5V, 0~10A	±2%	80mV	77%	83W
	15V, 0~4.0A	+3%, -7%	120mV		
RQ-85D	-5V, 0~1.0A	±8%	100mV		
	-15V, 0~1.0A	±5%	80mV		
	5V, 0~10A	±2%	80mV	78%	84W
	12V, 0~4.0A	+7%, -3%	120mV		
	24V, 0~1.5A	±8%	150mV		
	-12V, 0~1.0A	±5%	80mV		

125W — Quad Output (RT-125 without -5V or -12V output)

Model No.	Output	Tol.	R&N	Effi.	Max.
RQ-125B	5V, 0~12A	±2%	80mV	79%	120W
	12V, 0~4.5A	+8%, -3%	120mV		
	-5V, 0~1.0A	+6%, -10%	80mV		
RQ-125C	-12V, 0~1.0A	±5%	80mV		
	5V, 0~12A	±2%	80mV	80%	123W
	15V, 0~4.0A	+8%, -3%	120mV		
RQ-125D	-5V, 0~1.0A	+6%, -10%	80mV		
	-15V, 0~1.0A	±5%	80mV		
	5V, 0~12A	±2%	80mV	82%	124W
	12V, 0~4.0A	+8%, -3%	120mV		
	24V, 0~2.5A	±8%	150mV		
	-12V, 0~1.0A	±5%	80mV		

Enclosed-SE Series

450~1500W Single Output



Features

- AC input selectable by switch (SE-600/1000)
AC input 180~264VAC only (SE-1500)
- Protections:
Short circuit / Overload / Over voltage /
Over temperature
- Forced air cooling by built-in DC fan
- Built-in remote sense function
- DC OK, remote ON/OFF control (SE-1000/1500)
- LED indicator for power on
- 2 years warranty

General Specification (Please refer to www.meanwell.com for detail spec.)



Model No.	SE-450	SE-600	SE-1000	SE-1500
AC input voltage range	115/230VAC by switch			180~264VAC
AC inrush current (max.)	Cold start, 55A at 230VAC	Cold start, 60A at 230VAC	Cold start, 55A at 230VAC	Cold start, 60A at 230VAC
DC adjustment range	±10% rated output voltage			
Overload protection	Range	105%~150%	105%~125%	
	Type	Shut down o/p voltage, re-power on to recover		
Over voltage protection	115%~145%	115%~140% Shut down o/p voltage, re-power on to recover		
Withstand voltage	I/P-O/P: 3kVAC, I/P-FG: 1.5kVAC, O/P-FG: 0.5kVAC		I/P-O/P: 3kVAC, I/P-FG: 2kVAC, O/P-FG: 0.5kVAC	I/P-O/P: 3kVAC, I/P-FG: 1.5kVAC, O/P-FG: 0.5kVAC
Working temperature	-10~+60°C	-20~+60°C (refer to output derating curve)		-20~+70°C
Safety standards	UL62368-1, EAC TP TC 004, BSMI CNS14336-1, KC K60950-1(SE-600-12/24 only)approved, BIS IS 13252(SE-600/SE-1000, Except SE-1000-9)			
EMC standards	BS EN/EN55032 class B, EN61000-3-2,3, EN61000-4-2,3,4,5,6,8,11		Design refer to BS EN/EN55032 class B	
Connection	9P/11mm pitch terminal block with cover		Terminal block with cover for input and output (SE-1000/1500: bus bars for output)	
Dimension (LxWxH)(mm)	225x 124x 50	247x 127x 63.5	278x 127x 63.5	278x 177.8x 63.5

450W SE-450

Model No.	Output	Tol.	R&N	Effi.
SE-450-3.3	3.3V, 0~75A	±3%	200mV	74%
SE-450-5	5V, 0~75A	±3%	200mV	78%
SE-450-12	12V, 0~37.5A	±1%	200mV	83%
SE-450-15	15V, 0~30A	±1%	200mV	84%
SE-450-24	24V, 0~18.8A	±1.5%	200mV	86%
SE-450-36	36V, 0~12.5A	±1%	200mV	86%
SE-450-48	48V, 0~9.4A	±1%	200mV	88%

1000W SE-1000

Model No.	Output	Tol.	R&N	Effi.
SE-1000-5	5V, 0~150A	±1%	150mV	81%
SE-1000-9	9V, 0~100A	±1%	150mV	84%
SE-1000-12	12V, 0~83.3A	±1%	150mV	85%
SE-1000-15	15V, 0~66.7A	±1%	150mV	86%
SE-1000-24	24V, 0~41.7A	±1%	200mV	88%
SE-1000-48	48V, 0~20.8A	±1%	200mV	89%

600W SE-600

Model No.	Output	Tol.	R&N	Effi.
SE-600-5	5V, 0~100A	±2%	150mV	78%
SE-600-12	12V, 0~50A	±1%	150mV	83%
SE-600-15	15V, 0~40A	±1%	150mV	84%
SE-600-24	24V, 0~25A	±1%	150mV	87%
SE-600-27	27V, 0~22.2A	±1%	150mV	87%
SE-600-36	36V, 0~16.6A	±1%	200mV	87%
SE-600-48	48V, 0~12.5A	±1%	200mV	88%

1500W SE-1500

Model No.	Output	Tol.	R&N	Effi.
SE-1500-5	5V, 0~300A	±2%	150mV	81%
SE-1500-12	12V, 0~125A	±1%	150mV	85%
SE-1500-15	15V, 0~100A	±1%	150mV	85%
SE-1500-24	24V, 0~62.5A	±1%	150mV	87%
SE-1500-27	27V, 0~55.6A	±1%	150mV	88%
SE-1500-48	48V, 0~31.3A	±1%	150mV	89%

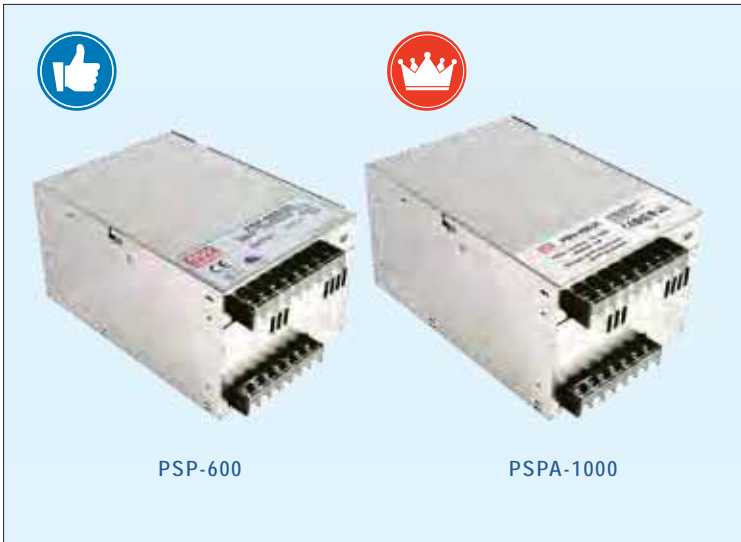

■ Features

- Universal AC input / Full range
- Built-in active PFC function
- Protections: Short circuit / Overload / Over voltage / Over temperature
- Forced air cooling by built-in DC fan
- With DC OK Signal output
- Current sharing up to 2400W(PSP-600); 4000W (PSPA-1000)
- Built-in remote ON-OFF control
- Built-in remote sense function
- 3 years warranty (PSP-600)
5 years warranty (PSPA-1000)

■ General Specification (Please refer to www.meanwell.com for detail spec.)



Model No.	PSP-600	PSPA-1000
AC input voltage range	88~264VAC ; 124~370VDC	90~264VAC ; 127~370VDC
AC inrush current (max.)	Cold start, 40A at 230VAC	
DC adjustment range	±10% rated output voltage	-8%~+17% rated output voltage
Overload protection	Range	105%~135%
	Type	Constant current limiting, auto-recovery
Over voltage protection	115%~140%	120%~137%
Withstand voltage	I/P-O/P: 3kVAC, I/P-FG: 2kVAC, O/P-FG: 0.5kVAC, 1 minute	
Working temperature	-20~+60°C (refer to output derating curve)	-20~+70°C (refer to output derating curve)
Safety standards	UL62368-1, TUV BS EN/EN62368-1, EAC TP TC 004, BSMI CNS14336-1,AS/NZS62368.1 approved; GB4943 approved for PSP-600	
EMC standards	BS EN/EN55032 class B, EN61000-3-2,3, EN61000-4-2,3,4,5,6,8,11; EAC TP TC 020; BSMI CNS13438	
Connection	7+8P / 9.5mm pitch terminal block with cover	
Dimension (LxWxH)(mm)	170x 120x 93	

■ 600W PSP-600

Model No.	Output	Tol.	R&N	Effi.
PSP-600-5	5V, 0~80.0A	±2%	180mV	79%
PSP-600-12	12V, 0~50.0A	±1%	240mV	84%
PSP-600-13.5	13.5V, 0~44.5A	±1%	240mV	85%
PSP-600-15	15V, 0~40.0A	±1%	240mV	85%
PSP-600-24	24V, 0~25.0A	±1%	240mV	86%
PSP-600-27	27V, 0~22.2A	±1%	240mV	86%
PSP-600-48	48V, 0~12.5A	±1%	300mV	87%

■ 1000W PSPA-1000

Model No.	Output	Tol.	R&N	Effi.
PSPA-1000-12	12V, 0~80A	±2%	150mV	92.0%
PSPA-1000-15	15V, 0~64A	±1.5%	150mV	93.0%
PSPA-1000-24	24V, 0~42A	±1%	200mV	93.5%
PSPA-1000-48	48V, 0~21A	±1%	250mV	94.0%

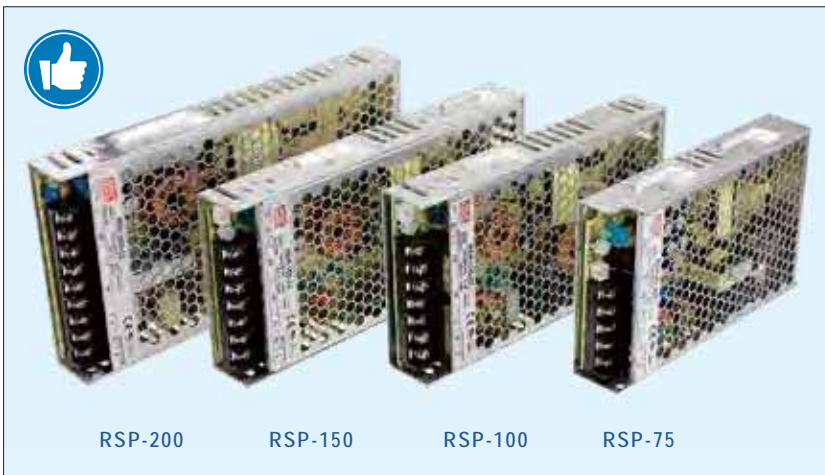

Features

- Ultra low profile: 30mm
- Universal AC input / Full range
- Built-in active PFC function
- Protections: Short circuit / Overload / Over voltage / Over temperature (RSP-100/150/200)
- Cooling by free air convection
- Built-in constant current limiting circuit (RSP-75/100/150)
- Remote ON/OFF control (RSP-75/100/150)
- LED indicator for power on
- 3 years warranty

General Specification (Please refer to www.meanwell.com for detail spec.)



Model No.	RSP-75	RSP-100	RSP-150	RSP-200
AC input voltage range	85~264VAC; 120~370VDC			88~264VAC; 124~370VDC
AC inrush current (max.)	Cold start, 35A at 230VAC	30A at 230VAC	45A at 230VAC	40A at 230VAC
DC adjustment range	-5%~+10% rated output voltage			±10% rated output voltage
Overload protection	Range	105%~135%	105%~150%	
	Type	Constant current limiting, auto-recovery		Hiccup mode, auto-recovery
Over voltage protection	Range	110%~135%		115%~145%
	Type	Shut down O/P voltage, re-power on to recover		
Withstand voltage	I/P-O/P: 4kVAC, I/P-FG: 2kVAC, O/P-FG: 0.5kVAC			I/P-O/P: 3kVAC, I/P-FG: 2kVAC, O/P-FG: 0.5kVAC
Working temperature	-25~+70°C		-30~+70°C (refer to output derating curve)	
Safety standards	UL62368-1, TUV BS EN/EN62368-1, EN61558-1, EN61558-2-16, CCC GB4943, EAC TP TC 004, BSMI CNS14336-1 approved			UL62368-1, TUV BS EN/EN62368-1, CCC GB4943, EAC TP TC 004, BSMI CNS14336-1 approved
EMC standards	BS EN/EN55032 class B, EN61000-3-2,3, EN61000-4-2,3,4,5,6,8,11; GB9254; EAC TP TC 020			
Connection	5P / 9.5mm pitch terminal block	7P / 9.5mm pitch terminal block	9P / 9.5mm pitch terminal block	9P / 9.5mm pitch terminal block
Dimension (LxWxH) (mm)	159x97x30	179x99x30	199x99x30	215x115x30

75W RSP-75

Model No.	Output	Tol.	R&N	Effi.
RSP-75-3.3	3.3V, 0~15A	±2%	80mV	76.0%
RSP-75-5	5V, 0~15A	±2%	80mV	82.0%
RSP-75-7.5	7.5V, 0~10A	±2%	80mV	84.0%
RSP-75-12	12V, 0~6.3A	±2%	120mV	85.0%
RSP-75-13.5	13.5V, 0~5.6A	±2%	120mV	85.0%
RSP-75-15	15V, 0~5A	±2%	120mV	86.0%
RSP-75-24	24V, 0~3.2A	±1%	120mV	87.0%
RSP-75-27	27V, 0~2.8A	±1%	120mV	88.0%
RSP-75-48	48V, 0~1.6A	±1%	200mV	89.0%

150W RSP-150

Model No.	Output	Tol.	R&N	Effi.
RSP-150-3.3	3.3V, 0~30A	±2%	100mV	81.5%
RSP-150-5	5V, 0~30A	±2%	100mV	87.0%
RSP-150-7.5	7.5V, 0~20A	±2%	100mV	88.5%
RSP-150-12	12V, 0~12.5A	±2%	100mV	89.0%
RSP-150-13.5	13.5V, 0~11.2A	±2%	100mV	87.5%
RSP-150-15	15V, 0~10A	±2%	100mV	88.5%
RSP-150-24	24V, 0~6.3A	±1%	150mV	89.0%
RSP-150-27	27V, 0~5.6A	±1%	150mV	89.5%
RSP-150-48	48V, 0~3.2A	±1%	250mV	90.0%

100W RSP-100

Model No.	Output	Tol.	R&N	Effi.
RSP-100-3.3	3.3V, 0~20A	±2%	100mV	83.0%
RSP-100-5	5V, 0~20A	±2%	100mV	86.0%
RSP-100-7.5	7.5V, 0~13.5A	±2%	100mV	87.0%
RSP-100-12	12V, 0~8.5A	±1%	100mV	86.0%
RSP-100-13.5	13.5V, 0~7.5A	±1%	100mV	86.5%
RSP-100-15	15V, 0~6.7A	±1%	100mV	87.0%
RSP-100-24	24V, 0~4.2A	±1%	150mV	87.0%
RSP-100-27	27V, 0~3.8A	±1%	150mV	87.0%
RSP-100-48	48V, 0~2.1A	±1%	250mV	88.0%

200W RSP-200

Model No.	Output	Tol.	R&N	Effi.
RSP-200-2.5	2.5V, 0~40A	±2%	100mV	79.5%
RSP-200-3.3	3.3V, 0~40A	±2%	100mV	81.5%
RSP-200-4	4V, 0~40A	±2%	100mV	84.0%
RSP-200-5	5V, 0~40A	±2%	150mV	85.5%
RSP-200-7.5	7.5V, 0~26.7A	±2%	150mV	89.0%
RSP-200-12	12V, 0~16.7A	±1%	150mV	89.0%
RSP-200-13.5	13.5V, 0~14.9A	±1%	150mV	89.0%
RSP-200-15	15V, 0~13.4A	±1%	150mV	89.5%
RSP-200-24	24V, 0~8.4A	±1%	150mV	89.5%
RSP-200-27	27V, 0~7.5A	±1%	200mV	89.0%
RSP-200-36	36V, 0~5.56A	±1%	220mV	90.0%
RSP-200-48	48V, 0~4.2A	±1%	240mV	90.0%



RSP-500

RSP-320

Features

- 1U low profile
- Universal AC input / Full range
- Built-in active PFC function
- Protections: Short circuit / Overload / Over voltage / Over temperature
- Forced air cooling by built-in DC fan
- Built-in remote sense and ON/OFF control (RSP-500)
- LED indicator for power on
- 3 years warranty

General Specification (Please refer to www.meanwell.com for detail spec.)



Model No.	RSP-320	RSP-500
AC input voltage range	88~264VAC; 124~370VDC	85~264VAC; 120~370VDC
AC inrush current (max.)	Cold start, 40A at 230VAC	
DC adjustment range	Vo: ±10% by potentiometer	
Overload protection	Range	105%~135%
	Type	Hiccup mode, auto-recovery
Over voltage protection	Range	115%~145%
	Type	Shut down O/P voltage, re-power on to recover
Withstand voltage	I/P-O/P: 3kVAC, I/P-FG: 2kVAC, O/P-FG: 0.5kVAC	
Working temperature	-30~+70°C (refer to output derating curve)	
Safety standards	UL62368-1, TUV BS EN/EN62368-1, EAC TP TC 004, BSMI CNS14336-1, CCC GB4943.1, AS/NZS62368-1 approved	
EMC standards	BS EN/EN55032 class B, EN61000-3-2,3, EN61000-4-2,3,4,5,6,8,11, EN61000-6-2(RSP-500); EAC TP TC 020, GB9254	
Connection	Input	9P / 9.5mm pitch terminal block
	Output	3P / 9.5mm pitch terminal block 6P / 11mm pitch terminal block
Dimension (LxWxH) (mm)	215x115x30	230x127x40.5

320W RSP-320

Model No.	Output	Tol.	R&N	Effi.
RSP-320-2.5	2.5V, 0~60A	±2%	100mV	75.5%
RSP-320-3.3	3.3V, 0~60A	±2%	100mV	79.5%
RSP-320-4	4V, 0~60A	±2%	100mV	81.0%
RSP-320-5	5V, 0~60A	±2%	150mV	83.0%
*RSP-320-5CC	5V, 0~60A	±2%	150mV	83.0%
RSP-320-7.5	7.5V, 0~40A	±2%	150mV	88.0%
RSP-320-12	12V, 0~26.7A	±1%	150mV	88.0%
RSP-320-13.5	13.5V, 0~23.8A	±1%	150mV	88.0%
RSP-320-15	15V, 0~21.4A	±1%	150mV	88.5%
RSP-320-24	24V, 0~13.4A	±1%	150mV	89.0%
RSP-320-27	27V, 0~11.9A	±1%	200mV	89.0%
RSP-320-36	36V, 0~8.9A	±1%	220mV	89.5%
RSP-320-48	48V, 0~6.7A	±1%	240mV	90.0%

* RSP-320-5CC with conformal coating is suitable for LED moving sign applications, MOQ required.

500W RSP-500

Model No.	Output	Tol.	R&N	Effi.
RSP-500-3.3	3.3V, 0~90A	±2%	120mV	81.0%
RSP-500-4	4V, 0~90A	±2%	120mV	83.0%
RSP-500-5	5V, 0~90A	±2%	150mV	84.0%
RSP-500-12	12V, 0~41.7A	±1%	150mV	88.0%
RSP-500-15	15V, 0~33.4A	±1%	150mV	88.0%
RSP-500-24	24V, 0~21A	±1%	150mV	89.0%
RSP-500-27	27V, 0~18.6A	±1%	150mV	89.5%
RSP-500-48	48V, 0~10.5A	±1%	150mV	90.5%



Features

- Universal AC input / Full range
- Protections: Short circuit / Overload / Over voltage / Over temperature
- Over temperature protection (200~320W built-in, option for 150W)
- Built-in active PFC function
- Forced air cooling by built-in DC fan
- 3 years warranty

General Specification (Please refer to www.meanwell.com for detail spec.)



Model No.	QP-150	QP-200	QP-320
AC input voltage range	90~264VAC; 127~370VDC		
AC inrush current (max.)	Cold start, 40A at 230VAC	Cold start, 50A at 230VAC	Cold start, 45A at 230VAC
DC adjustment range	CH1: -5%~+10% rated output voltage (CH1&2 for QP-150-3x, QP-150-D/F)	CH1&2: -5%~+10% rated output voltage	
Overload protection	Range	105%~150%	
	Type	Hiccup mode, auto-recovery	Constant current limiting, auto-recovery
Over voltage protection	115%~135% for CH1 or CH1&2		
Withstand voltage	I/P - O/P: 3kVAC, I/P - FG: 2kVAC, O/P - FG: 0.5kVAC, 1 minute		
Working temperature	-10~+60°C (refer to output derating curve)		-10~+70°C
Setup, rise, hold up time	800ms, 60ms, 24ms at full load and 30VAC (TP-100/150); 1800ms, 50ms, 24ms at full load and 230VAC (QP-150)	800ms, 50ms, 24ms at full load and 230VAC	800ms, 50ms, 16ms at full load and 230VAC
Safety standards	UL62368-1, TUV BS EN/EN62368-1 approved		
EMC standards	BS EN/EN55032 class B, EN61000-3-2,3, EN61000-4-2,3,4,5,6,8,11		
Connection	9P/7.62mm pitch terminal block with cover	9P/9.5mm pitch terminal block with cover	
Dimension (LxWxH)(mm)	199x 99x 50	215x 115x 50	

150W — Quad Output

Model No.	Output	Tol.	R&N	Effi.	Max.	Model No.	Output	Tol.	R&N	Effi.	Max.
QP-150B	5V, 3.0~15A	±3%	100mV	76%	150W	QP-150D	5V, 3.0~15A	±3%	120mV	78%	150W
	12V, 0.4~5.0A	±6%	150mV				12V, 0.0~5.0A	±3%	150mV		
	-12V, 0.3~2.0A	+10%, -6%	150mV				24V, 0.4~3.0A	±6%	200mV		
	-5V, 0.0~1.0A	±5%	100mV				-12V, 0.0~1.0A	±5%	150mV		
QP-150C	5V, 3.0~15A	±3%	100mV	77%	153W	QP-150F	5V, 3.0~15A	±3%	120mV	78%	152W
	15V, 0.4~4.0A	+6%, -10%	150mV				15V, 0.0~5.0A	±3%	150mV		
	-15V, 0.3~2.0A	±8%	150mV				24V, 0.4~3.0A	±6%	200mV		
	-5V, 0.0~1.0A	±5%	100mV				-15V, 0.0~1.0A	±5%	150mV		

150W – Quad Output

Model No.	Output	Tol.	R&N	Effi.	Max.
QP-150-3A	5V, 3.0~15A	±3%	100mV	73%	146W
	3.3V, 0.0~15A	±3%	100mV		
	12V, 0.4~5.0A	±6%	150mV		
	-5V, 0.0~1.0A	±5%	150mV		
QP-150-3B	5V, 3.0~15A	±3%	100mV	75%	150W
	3.3V, 0.0~15A	±3%	100mV		
	12V, 0.4~5.0A	±6%	150mV		
	-12V, 0.0~1.0A	±5%	150mV		
QP-150-3C	5V, 3.0~15A	±3%	100mV	74%	152W
	3.3V, 0.0~15A	±3%	100mV		
	15V, 0.4~5.0A	+8%, -6%	150mV		
	-15V, 0.0~1.0A	±5%	150mV		
QP-150-3D	5V, 3.0~15A	±3%	100mV	76%	150W
	3.3V, 0.0~15A	±3%	100mV		
	24V, 0.3~3.0A	±6%	150mV		
	-12V, 0.0~1.0A	±5%	150mV		

200W – Quad Output

Model No.	Output	Tol.	R&N	Effi.	Max.
QP-200D	5V, 3.0~20A	±3%	100mV	75%	203W
	12V, 0.0~7.0A	±3%	150mV		
	24V, 0.4~6.0A	+10%, -6%	150mV		
	-12V, 0.0~1.0A	±6%	150mV		
QP-200F	5V, 3.0~20A	±3%	100mV	75%	203W
	15V, 0.0~6.0A	±3%	150mV		
	-15V, 0.0~1.0A	±6%	150mV		

320W – Quad Output

Model No.	Output	Tol.	R&N	Effi.	Max.
QP-320D	5V, 2.5~20A	±3%	100mV	83%	316W
	12V, 0.0~10A	±3%	150mV		
	24V, 0.2~5.0A	+10%, -6%	150mV		
	-12V, 0.2~2.0A	±10%	150mV		
QP-320F	5V, 2.5~20A	±3%	100mV	83%	316W
	15V, 0.0~10A	±3%	150mV		
	24V, 0.2~5.0A	+10%, -6%	150mV		
	-15V, 0.2~1.6A	±10%	150mV		

2750W Laser Diode PWM Driver Module



Features

- Output current 0~50A
- Compliance voltage to 55V
- 2.75kW maximum output power
- High efficiency up to 96%
- Short rise/fall time (2μs for fast mode)
- Continue wave application
- Low current ripple <1Arms
- Dimension(LxWxH): 250x 100x 41mm
- 5 years warranty

LRS-450/600 Series
450W~600W Low Profile

Under Development

LRS-450 LRS-600

- 115/230Vac input selectable by s.w
- Withstand 300Vac surge input for 5 seconds
- 1U low profile
- -25~+70 wide working temperature
- Built-in FAN ON/OFF control
- Operating altitude up to 5000 meters
- Protections: short circuit/OLP/OVP/OTP
- Safety: CB/UL/BSMI/CQC/BIS/EAC/CE/UKCA
- Models: 5V/12V/15V/24V/36V/48V
- Dimension(LxWxH): 225x 124x 35mm(450W)
225x 124x 41mm(600W)
- 3 years warranty



HRP-150
HRPG-150

HRP-100

HRP-75

Features

- Universal AC input / Full range
- Withstand 300VAC surge input for 5 seconds
- Built-in active PFC function
- Protections:
 - Short circuit / Overload / Over voltage /
 - Over temperature (optional for HRP-75 / HRP-100)
- Built-in constant current limiting circuit
- Built-in remote sense function (HRP□-150)
- No load power consumption < 0.5W (except for HRP-150)
- Built-in remote ON/OFF control (except for HRP-150)
- Built-in 5V / 0.3A standby output (HRPG-150)
- Cooling by free air convection
- 1U low profile
- LED indicator for power on
- 5 years warranty

General Specification (Please refer to www.meanwell.com for detail spec.)



Model No.	HRP-75	HRP-100	HRP□-150
AC input voltage range	85~264VAC; 120~370VDC		
AC inrush current (max.)	Cold start, 65A at 230VAC		Cold start; 70A at 230VAC
DC adjustment range	-5%~+10% rated output voltage		±15% rated output voltage
Overload protection	Range	105%~135%	
	Type	Constant current limiting, auto-recovery	
Over voltage protection	115%~145%		
Withstand voltage	I/P-O/P: 3kVAC, I/P-FG: 1.5kVAC, O/P-FG: 0.5kVAC, 1 minute		
Working temperature	-40~+70°C (refer to output derating curve)	-40~+60°C	-40~+70°C
Safety standards	UL62368-1, TUV BS EN/EN62368-1, EAC TP TC 004, AS/NZS62368.1 approved		
EMC standards	BS EN/EN55032 class B, EN61000-4-2,3,4,5,6,8,11, EN61000-3-2,3, EN55024, EN61000-6-2 heavy industry level; EAC TP TC 020		
Connection	5P/9.5mm pitch terminal block with cover	7P/9.5mm pitch terminal block with cover	
Dimension (LxWxH)(mm)	129x98x38	159x97x38	

75W HRP-75

Model No.	Output	Tol.	R&N	Effi.
HRP-75-3.3	3.3V, 0~15A	±2.5%	80mV	77.0%
HRP-75-5	5V, 0~15A	±2.5%	80mV	82.5%
HRP-75-7.5	7.5V, 0~10A	±2.5%	100mV	84.0%
HRP-75-12	12V, 0~6.3A	±1.5%	120mV	87.0%
HRP-75-15	15V, 0~5A	±1.5%	150mV	88.0%
HRP-75-24	24V, 0~3.2A	±1.5%	150mV	88.5%
HRP-75-36	36V, 0~2.1A	±1.5%	200mV	89.0%
HRP-75-48	48V, 0~1.6A	±1.5%	240mV	89.0%

Model No.	Output	Tol.	R&N	Effi.
HRP-100-15	15V, 0~7A	±1.5%	150mV	88.0%
HRP-100-24	24V, 0~4.5A	±1.5%	150mV	88.5%
HRP-100-36	36V, 0~2.9A	±1.5%	200mV	89.0%
HRP-100-48	48V, 0~2.2A	±1.5%	240mV	90.0%

100W HRP-100

Model No.	Output	Tol.	R&N	Effi.
HRP-100-3.3	3.3V, 0~20A	+2.5%, -3.5%	80mV	78.0%
HRP-100-5	5V, 0~17A	±2.5%	80mV	83.0%
HRP-100-7.5	7.5V, 0~13.5A	±2.5%	100mV	84.0%
HRP-100-12	12V, 0~8.5A	±1.5%	120mV	87.5%

150W HRP□-150

Model No.	Output	Tol.	R&N	Effi.
HRP□-150-3.3	3.3V, 0~30A	±2.5%	80mV	78.5%
HRP□-150-5	5V, 0~26A	±2.5%	80mV	85.0%
HRP□-150-7.5	7.5V, 0~20A	±2.5%	100mV	87.0%
HRP□-150-12	12V, 0~13A	±1.5%	120mV	88.0%
HRP□-150-15	15V, 0~10A	±1.5%	150mV	88.0%
HRP□-150-24	24V, 0~6.5A	±1.5%	150mV	88.0%
HRP□-150-36	36V, 0~4.3A	±1.5%	200mV	89.0%
HRP□-150-48	48V, 0~3.3A	±1.5%	240mV	89.0%

□=blank, G; blank: basic function, G: with 5Vsb & no load < 0.5W



HRP-450
HRPG-450

HRP-300
HRPG-300

HRP-200
HRPG-200

Features

- Universal AC input / Full range
- Withstand 300VAC surge input for 5 seconds
- Built-in active PFC function
- Protections: Short circuit / Overload / Over voltage / Over temperature
- Built-in constant current limiting circuit
- Built-in remote sense function
- Built-in DC OK signal
- No load power consumption < 0.5W (HRPG-300/450)
- Built-in remote ON/OFF control & 5V / 0.3A standby output (HRPG series)
- Forced air cooling by built-in DC fan
- 1U low profile
- **5 years warranty**

General Specification (Please refer to www.meanwell.com for detail spec.)



Model No.	HRP□-200	HRP□-300	HRP□-450
AC input voltage range	85~264VAC; 120~370VDC		
AC inrush current (max.)	Cold start, 70A at 230VAC		
DC adjustment range	±15% rated output voltage		
Overload Protection	Range	105%~135%	
	Type	Constant current limiting, auto-recovery	
Over voltage protection	115%~145%		
Withstand voltage	I/P - O/P: 3kVAC, I/P - FG: 1.5kVAC, O/P - FG: 0.5kVAC, 1 minute	I/P - O/P: 3kVAC, I/P - FG: 2kVAC, O/P - FG: 0.5kVAC, 1 minute	
Working temperature	-40~+70°C (refer to output derating curve)		
Safety standards	UL62368-1, TUV BS EN/EN62368-1, EAC TP TC 004, AS/NSZ62368.1 approved		
EMC standards	BS EN/EN55032 class B, EN61000-4-2,3,4,5,6,8,11, EN61000-3-2,3, EN55024, EN61000-6-2 heavy industry level; EAC TP TC 020	BS EN/EN55032 class B, EN61000-4-2,3,4,5,6,8,11, EN61000-3-2,3, EN61000-6-2 heavy industry level; EAC TP TC 020, AS/NSZ62368.1	
Connection	7P/9.5mm pitch terminal block with cover	7P/11mm	3+6P/10&11mm
Dimension (LxWxH)(mm)	199x 98x 38	199x105x41	218x105x41

200W HRP□-200

Model No.	Output	Tol.	R&N	Effi.
HRP□-200-3.3	3.3V, 0~40A	±2%	80mV	80.0%
HRP□-200-5	5V, 0~35A	±2%	90mV	84.0%
HRP□-200-7.5	7.5V, 0~26.7A	±2%	100mV	86.0%
HRP□-200-12	12V, 0~16.7A	±1%	120mV	88.0%
HRP□-200-15	15V, 0~13.4A	±1%	150mV	88.0%
HRP□-200-24	24V, 0~8.4A	±1%	150mV	88.0%
HRP□-200-36	36V, 0~5.7A	±1%	250mV	89.0%
HRP□-200-48	48V, 0~4.3A	±1%	250mV	89.0%

□ = blank, G; blank: basic function, G: with 5Vsb & no load < 0.5W

300W HRP□-300

Model No.	Output	Tol.	R&N	Effi.
HRP□-300-3.3	3.3V, 0~60A	±2.5%	80mV	80.0%
HRP□-300-5	5V, 0~60A	±2.0%	90mV	82.0%
HRP□-300-7.5	7.5V, 0~40A	±2.0%	100mV	86.0%
HRP□-300-12	12V, 0~27A	±1.0%	120mV	88.0%

□ = blank, G; blank: basic function, G: with 5Vsb & no load < 0.5W

Model No.	Output	Tol.	R&N	Effi.
HRP□-300-15	15V, 0~22A	±1.0%	150mV	88.0%
HRP□-300-24	24V, 0~14A	±1.0%	150mV	87.0%
HRP□-300-36	36V, 0~9A	±1.0%	250mV	88.0%
HRP□-300-48	48V, 0~7A	±1.0%	250mV	89.0%

□ = blank, G; blank: basic function, G: with 5Vsb & no load < 0.5W

450W HRP□-450

Model No.	Output	Tol.	R&N	Effi.
HRP□-450-3.3	3.3V, 0~90A	±2%	80mV	80.0%
HRP□-450-5	5V, 0~90A	±2%	80mV	83.0%
HRP□-450-7.5	7.5V, 0~60A	±2%	100mV	86.5%
HRP□-450-12	12V, 0~37.5A	±1%	120mV	88.0%
HRP□-450-15	15V, 0~30A	±1%	150mV	89.0%
HRP□-450-24	24V, 0~18.8A	±1%	150mV	88.0%
HRP□-450-36	36V, 0~12.5A	±1%	240mV	89.0%
HRP□-450-48	48V, 0~9.5A	±1%	240mV	89.5%

□ = blank, G; blank: basic function, G: with 5Vsb & no load < 0.5W



■ Features

- Universal AC input / Full range
- Withstand 300VAC surge input for 5 seconds
- Built-in active PFC function
- Protections: Short circuit / Overload / Over voltage / Over temperature
- Built-in constant current limiting circuit
- Built-in remote sense function
- Built-in DC OK signal
- No load power consumption < 0.75W
- Built-in remote ON/OFF control & 5V / 0.3A standby output (HRPG series)
- Built-in current sharing (HRPG-600-24/36/48; HRPG-1000)
- Forced air cooling by built-in DC fan
- 5 years warranty

■ General Specification (Please refer to www.meanwell.com for detail spec.)



Model No.	HRP□-600	HRPG-1000
AC input voltage range	85~264VAC; 120~370VDC	90~264VAC; 127~370VDC
AC inrush current (max.)	Cold start, 70A at 230VAC	Cold start, 40A at 230VAC
DC adjustment range	±15% rated output voltage	-8%~+17% rated output voltage
Overload Protection	Range	105%~135%
	Type	Constant current limiting, auto-recovery
Over voltage protection	115%~145%	120%~137%
Withstand voltage	I/P - O/P: 3kVAC, I/P - FG: 2kVAC, O/P - FG: 0.5kVAC, 1 minute	
Working temperature	-40~+70°C (refer to output derating curve)	
Safety standards	UL62368-1, TUV BS EN/EN62368-1, EAC TP TC 004, AS/NSZ62368.1 approved	
EMC standards	BS EN/EN55032 class B, EN61000-4-2,3,4,5,6,8,11, EN61000-3-2,3, EN61000-6-2 heavy industry level, EAC TP TC 020, AS/NSZ62368.1	BS EN/EN55032 class A, EN61000-4-2,3,4,5,6,8,11, EN61000-3-2,3, EAC TP TC 020, AS/NSZ62368.1
Connection	3+6P/10&11mm pitch terminal block with cover	
Dimension (LxWxH)(mm)	218x105x63.5	

■ 600W HRP□-600

Model No.	Output	Tol.	R&N	Effi.
HRP□-600-3.3	3.3V, 0~120A	±2%	120mV	78.5%
HRP□-600-5	5V, 0~120A	±2%	150mV	82.0%
HRP□-600-7.5	7.5V, 0~80A	±2%	150mV	87.0%
HRP□-600-12	12V, 0~53A	±1%	150mV	88.0%
HRP□-600-15	15V, 0~43A	±1%	150mV	88.0%
HRP□-600-24	24V, 0~27A	±1%	150mV	88.0%
HRP□-600-36	36V, 0~17.5A	±1%	200mV	89.0%
HRP□-600-48	48V, 0~13A	±1%	240mV	89.0%

□ = blank, G; blank: basic function, G: with 5Vsb & no load < 0.75W

■ 1000W HRPG-1000

Model No.	Output	Tol.	R&N	Effi.
HRPG-1000-12	12V, 0~80A	±2%	150mV	91.5%
HRPG-1000-15	15V, 0~64A	±1.5%	150mV	92.0%
HRPG-1000-24	24V, 0~42A	±1%	200mV	93.0%
HRPG-1000-48	48V, 0~21A	±1%	250mV	94.0%



■ Features

- Universal AC input/ Full range
- Built-in active PFC function, PF>0.95
- **250% peak power capability**
- High efficiency up to 89%
- Withstand 300VAC surge input for 5 seconds
- Protections:
Short circuit / Overload / Over voltage / Over temperature
- Cooling by free air convection
- Built-in constant current limiting circuit
- 1U low profile 38mm (HRP-150N); 41mm (HRP-300N)
- Built-in remote sense function
- **5 years warranty**

■ General Specification (Please refer to www.meanwell.com for detail spec.)



Model No.	HRP-150N	HRP-300N	HRP-600N
AC input voltage range	85~264VAC; 120~370VDC		
AC inrush current (max.)	Cold start, 70A at 230VAC		
DC adjustment range	±15% rated output voltage		
Overload protection	Range	105%~135%	
	Type	Constant current limiting, auto-recovery	
Over voltage protection	115%~145%		
Withstand voltage	I/P - O/P: 3kVAC, I/P - FG: 2kVAC, O/P - FG: 0.5kVAC, 1 minute		
Working temperature	-40~+70°C (refer to output derating curve)		
Safety standards	UL62368-1, TUV EN62368-1, EAC TP TC 004 approved		
EMC standards	Compliance to EN55032 (CISPR32) Class B, EN61000-3-2,-3, EAC TP TC 020 ; Compliance to EN61000-4-2,3,4,5,6,8, 11, EN55024, EN61000-6-2, heavy industry level, criteria A, EAC TP TC 020		
Connection	7P/9.5mm pitch terminal block with cover	7P/11mm pitch terminal block with cover	3+6P/10&11mm pitch terminal block with cover
Dimension (LxWxH)(mm)	159x 97x 38	199x 105x 41	218x 105x 63.5

■ 150W HRP-150N

Model No.	Output	Tol.	R&N	Effi.
HRP-150N-12	12V, 0~13A	±1.5%	120mV	88%
HRP-150N-24	24V, 0~6.5A	±1.5%	150mV	88%
HRP-150N-36	36V, 0~4.3A	±1.5%	200mV	89%
HRP-150N-48	48V, 0~3.3A	±1.5%	240mV	89%

■ 600W HRP-600N

Model No.	Output	Tol.	R&N	Effi.
HRP-600N-12	12V, 0~53A	±1%	150mV	88%
HRP-600N-24	24V, 0~27A	±1%	150mV	88%
HRP-600N-36	36V, 0~17.5A	±1%	200mV	89%
HRP-600N-48	48V, 0~13A	±1%	240mV	89%

■ 300W HRP-300N

Model No.	Output	Tol.	R&N	Effi.
HRP-300N-12	15V, 0~27A	±1%	120mV	88%
HRP-300N-24	24V, 0~14A	±1%	150mV	87%
HRP-300N-36	36V, 0~9A	±1%	250mV	88%
HRP-300N-48	48V, 0~7A	±1%	250mV	89%

HRP vs. HRP-N/N3

Series	Difference	Peak Power
HRP-150/300/600		100%
HRP-150N/300N/600N		250%
HRP-150N3/300N3/600N3		300~350%



Features

- 1U low profile (41mm)
- Universal AC input / Full range
- Built-in active PFC function
- Protections: Short circuit / Overload / Over voltage / Over temperature
- Forced air cooling by built-in DC fan
- High power density up to 25W/in³ (RSP-1600)
- Output voltage programmable
- Constant current level I_{cc} programmable (RSP-750/1600)
- Built-in current sharing up to 4 units (RSP-1000/2000) or 6 units (RSP-1600)
- Built-in remote sense and ON/OFF control
- Built-in auxiliary power, DC OK signal
- OTP alarm signal output (RSP-1600/2000)
- Optional conformal coating
- 5 years warranty

General Specification



Model No.	RSP-750	RSP-1000	RSP-1600	RSP-2000
AC input voltage range	90~264VAC; 127~370VDC			90~264VAC; 127~320VDC
AC inrush current (max.)	Cold start, 40A at 230VAC		Cold start, 35A at 230VAC	Cold start, 50A at 230VAC
DC adjustment range	Vo: ±10% by potentiometer, or to 40%~110% of rated output voltage by 2~5.5VDC external control signal I _{cc} : to 40%~110% of rated output current by 2~5.5VDC external control signal	Vo: ±10% by potentiometer, or to 40%~110% of rated output voltage by external resistor or by 2~5.5VDC external control signal	Vo: -1%~+22.5% by potentiometer, or to 40%~125% of rated output voltage by 1~5VDC external control signal I _{cc} : to 20%~100% of rated output current by 1~5VDC external control signal	Vo: ±10% by potentiometer, or to 40%~115% of rated output voltage by 1~4.7VDC external control signal
Overload protection	Range	105%~125%	105%~125%	105%~115%
	Type	Constant current limiting, auto-recovery		Constant current limiting, shut down o/p voltage after 5 sec., re-power on to recover
Over voltage protection	Range	115%~145%	115%~135%	130%~155%
	Type	Shut down O/P voltage, re-power on to recover		
Withstand voltage	I/P-O/P: 3kVAC, I/P-FG: 2kVAC, O/P-FG: 0.5kVAC (O/P-FG: 1.5kVAC for RSP-1600)			
Working temperature	-30~+70°C	-20~+60°C	-30~+70°C	-35~+70°C
Safety standards	UL62368-1, TUV BS EN/EN62368-1, EAC TP TC 004, BSMI CNS14336-1 approved			
EMC standards	BS EN/EN55032 class B for RSP-750, class A for RSP-1000/1600/2000; EN61000-3-2,3; EN61000-4-2,3,4,5,6,8,11, EN61204-3			
Connection	Input	3P / 10mm pitch terminal block with cover		
	Output	M5x12 screw terminal	Bus bars	M5x12 screw terminal
Dimension (LxWxH) (mm)	250x127x41	295x 127x 41	300x 85x 41	295x 127x 41

750W RSP-750

Model No.	Output	Tol.	R&N	Effi.
RSP-750-5	5V, 0~100A	±2%	150mV	82.0%
RSP-750-12	12V, 0~62.5A	±1%	150mV	87.0%
RSP-750-15	15V, 0~50A	±1%	150mV	89.0%
RSP-750-24	24V, 0~31.3A	±1%	150mV	90.5%
RSP-750-27	27V, 0~27.8A	±1%	150mV	90.5%
RSP-750-48	48V, 0~15.7A	±1%	150mV	92.0%

1600W RSP-1600

Model No.	Output	Tol.	R&N	Effi.
RSP-1600-12	12V, 0~125A	±1%	150mV	89.0%
RSP-1600-24	24V, 0~67A	±1%	200mV	91.5%
RSP-1600-27	27V, 0~59A	±1%	200mV	92.0%
RSP-1600-36	36V, 0~44.5A	±1%	250mV	92.0%
RSP-1600-48	48V, 0~33.5A	±1%	300mV	93.0%

1000W RSP-1000

Model No.	Output	Tol.	R&N	Effi.
RSP-1000-12	12V, 0~60A	±1%	150mV	83%
RSP-1000-15	15V, 0~50A	±1%	150mV	85%
RSP-1000-24	24V, 0~40A	±1%	150mV	88%
RSP-1000-27	27V, 0~37A	±1%	150mV	88%
RSP-1000-48	48V, 0~21A	±1%	150mV	90%

2000W RSP-2000

Model No.	Output	Tol.	R&N	Effi.
RSP-2000-12	12V, 0~100A	±2%	150mV	87.0%
RSP-2000-24	24V, 0~80A	±1%	200mV	90.5%
RSP-2000-48	48V, 0~42A	±1%	300mV	92.0%



RSP-2400/3000

RSP-1500

Features

- Universal AC input / Full range (RSP-1500)
AC input 180~264VAC only (RSP3000)
- Built-in active PFC function
- Protections:
Short circuit / Overload / Over voltage /
Over temperature
- Forced air cooling by built-in DC fan
- **Output voltage programmable**
- Built-in current sharing up to 4 units (RSP-1500)
or 3 units (RSP-3000)
- Built-in remote sense and ON/OFF control
- Built-in auxiliary power, DC OK signal
- Optional conformal coating
- **5 years warranty**

General Specification (Please refer to www.meanwell.com for detail spec.)



Model No.	RSP-1500	RSP-2400	RSP-3000
AC input voltage range	90~264VAC; 127~370VDC	180~264VAC; 254~370VDC	
AC inrush current (max.)	Cold start, 60A at 230VAC		
DC adjustment range	Vo: -30%~+10% by potentiometer, or to 70%~100% of rated output voltage by external resistor	Vo: ±10% by potentiometer, or to 20%~110% of rated output voltage by 1~5.5VDC external control signal	
Overload protection	Range	105%~135%	100%~112%
	Type	Constant current limiting, shut off after 5 sec., re-power on to recover	Constant current limiting, shut off after 5 sec., re-power on to recover (can adjust to continuous constant current limiting)
Over voltage protection	Range	115%~140%	
	Type	Shut down O/P voltage, re-power on to recover	
Withstand voltage	I/P-O/P: 3kVAC, I/P-FG: 2kVAC, O/P-FG: 0.5kVAC		
Working temperature	-20~+70°C		
Safety standards	UL62368-1, TUV BS EN/EN62368-1, EAC TP TC 004, BSMI CNS14336-1 approved		
EMC standards	BS EN/EN55032, EN61000-3-2,3; EN61000-4-2,3,4,5,6,8,11, EN61000-6-2, EN61204-3		
Connection	Input	3P/13mm pitch terminal block with cover	
	Output	Bus bars	
Dimension (LxWxH) (mm)	278x 127x 83.5	278x 177.8x 63.5	

1500W RSP-1500

Model No.	Output	Tol.	R&N	Effi.
RSP-1500-5	5V, 0~240A	±2%	150mV	80%
RSP-1500-12	12V, 0~125A	±1%	150mV	87%
RSP-1500-15	15V, 0~100A	±1%	150mV	87%
RSP-1500-24	24V, 0~63A	±1%	150mV	90%
RSP-1500-27	27V, 0~56A	±1%	150mV	90%
RSP-1500-48	48V, 0~32A	±1%	200mV	91%

2400W RSP-2400

Model No.	Output	Tol.	R&N	Effi.
RSP-2400-12	12V, 0~166.7A	±1%	150mV	88.0%
RSP-2400-24	24V, 0~100A	±1%	150mV	90.5%
RSP-2400-48	48V, 0~50A	±1%	200mV	91.5%

3000W RSP-3000

Model No.	Output	Tol.	R&N	Effi.
RSP-3000-12	12V, 0~200A	±1%	150mV	87.5%
RSP-3000-24	24V, 0~125A	±1%	150mV	90.0%
RSP-3000-48	48V, 0~62.5A	±1%	200mV	91.5%



CSP-3000

■ Features

- AC input 180~264VAC only
- Built-in active PFC function
- High efficiency up to 93%
- Protections:
Short circuit / Overload / Over voltage / Over temperature
- Forced air cooling by built-in DC fan
- **Output voltage and current programmable**
- Built-in **current sharing up to 3 units**
- Built-in remote ON/OFF control
- Built-in auxiliary power, DC OK signal
- Optional conformal coating
- **5 years warranty**

■ General Specification (Please refer to www.meanwell.com for detail spec.)



Model No.	CSP-3000	
AC input voltage range	180~264VAC; 254~370VDC	
AC inrush current (max.)	Cold start, 60A at 230VAC	
DC adjustment range	Vo: ±10% by potentiometer, or to 20%~110% of rated output voltage by 2~10VDC external control signal	
Overload protection	Range	105%~120%
	Type	Constant current limiting with delay shutdown after 3 seconds, re-power to recover
Over voltage protection	Range	105%~125%
	Type	Shut down o/p voltage, re-power on to recover
Withstand voltage	I/P-O/P: 3kVAC, I/P-FG: 2kVAC, O/P-FG: 0.5kVAC	
Working temperature	-20~+70°C	
Safety standards	UL62368-1, TUV BS EN/EN62368-1, EAC TP TC 004 , BSMI CNS14336-1, GP4943.1 approved	
EMC standards	BS EN/EN55032, EN61000-3-2,3; EN61000-4-2,3,4,5,6,8,11, EN61000-6-2, EN61204-3	
Connection	Input	3P/13mm pitch terminal block with cover
	Output	2P/16mm pitch terminal block with cover
Dimension (LxWxH) (mm)	278x 177.8x 63.5	

■ 3000W

CSP-3000

Model No.	Output	Tol.	R&N	Effi.
CSP-3000-120	120V, 0~25A	±1%	800mV	92.0%
CSP-3000-250	250V, 0~12A	±1%	1000mV	92.5%
CSP-3000-400	400V, 0~7.5A	±1%	1200mV	93.0%



Features

- 3 ϕ 3-wire/ Δ 230VAC or 3 ϕ 4-wire/ Y 380VAC
- Built-in active PFC function
- High efficiency up to 92.5%
- Protections:
 - Short circuit / Overload / Over voltage / Over temperature / Fan alarm
- Forced air cooling by built-in DC fan
- Output voltage and constant current level I_{cc} programmable
- Built-in current sharing up to 4 units
- Built-in remote sense and ON/OFF control
- Built-in 12V/0.1A auxiliary power
- Alarm signal output
- 5 years warranty

General Specification (Please refer to www.meanwell.com for detail spec.)



Model No.	RST-5000	RST-7K5
AC input voltage range	3 ϕ 3-wire/ Δ 196~305VAC or 3 ϕ 4-wire/ Y 340~530VAC	
AC inrush current (max.)	Cold start, 75A at 230Vac (3 ϕ 3-wire/ Δ) or 50A at 400Vac (3 ϕ 4-wire/ Y)	Cold start, 75A at 230Vac (3 ϕ 3-wire/ Δ) or 50A at 230Vac (3 ϕ 4-wire/ Y)
DC adjustment range	V _o : 24V-23.5~28.8V, 36V-35~43.2V, 48V-47~57.6V by VR, 20~120% by 1~6VDC I _{cc} : 20~100% by 1~5VDC	V _o : 115V-90~138V, 230V-170~260V, 380V-334~400V by VR, or 1~120% by 1~6VDC I _{cc} : 20~100% by 1~4.8VDC
Overload protection	Range	100%~112%
	Type	User adjustable continuous constant current limiting or constant current limiting with delay shutdown after 5 seconds. Re-power on to recover.
Over voltage protection	Range	125%~145%
	Type	Shut down O/P voltage, re-power on to recover
Withstand voltage	I/P-O/P: 3kVAC, I/P-FG: 2kVAC, O/P-FG: 0.5kVAC	
Working temperature	-30~+70°C (refer to output derating curve)	
Safety standards	UL62368-1, TUV BS EN/EN62368-1, EAC TP TC 004 approved	
EMC standards	BS EN/EN55032 class A, EN61000-3-2,3, EN61000-4-2,3,4,5,6,8,11, EN61000-6-2, EN61204-3	BS EN/EN55032/EN55011 conducted class B, EN55032/EN55011 Radiated class A, EN61000-3-2,3, EN61000-4-2,3,4,5,6,8,11, EN61000-6-2, EN61204-3
Connection	Input	6P/13mm pitch terminal block with cover
	Output	Bus bars
Dimension (LxWxH) (mm)	460x 211x 83.5	

5000W RST-5000

Model No.	Output	ToI.	R&N	Effi.
RST-5000-24	24V, 0~200A	±1%	150mV	89%
RST-5000-36	36V, 0~138A	±1%	200mV	90%
RST-5000-48	48V, 0~105A	±1%	200mV	91%

7500W RST-7K5

Model No.	Output	ToI.	R&N	Effi.
RST-7K5-115	115V, 0~65.2A	±1%	1V	91%
RST-7K5-230	230V, 0~34.7A	±1%	2V	92%
RST-7K5-380	380V, 0~22.5A	±1%	4V	92.5%



Features

- 3 ϕ 3-wire/ Δ 230VAC or 3 ϕ 4-wire/ Y 380VAC
- Built-in active PFC function
- High efficiency up to 92.5%
- Protections: Short circuit / Overload / Over voltage / Over temperature / Fan alarm
- Forced air cooling by built-in DC fan
- Output voltage and constant current level I_{cc} programmable
- Built-in current sharing up to 4 units
- Built-in remote sense and ON/OFF control
- Built-in 12V/0.1A auxiliary power
- Alarm signal output
- 5 years warranty

General Specification (Please refer to www.meanwell.com for detail spec.)



Model No.		RST-10000	RST-15K
AC input voltage range		3 ϕ 3-wire/ Δ 196~305VAC or 3 ϕ 4-wire/ Y 340~530VAC	
AC inrush current (max.)		Cold start, 150A at 230VAC (3 ϕ 3-wire/ Δ) or 100A at 400VAC (3 ϕ 4-wire/ Y)	Cold start, 75A at 230VAC (3 ϕ 3-wire/ Δ) or 50A at 230VAC (3 ϕ 4-wire/ Y)
DC adjustment range		V _o : 24V-23.5~28.8V, 36V-35~43.2V, 48V-47~57.6V by VR, 20~120% by 1~6VDC I _{cc} : 20~100% by 1~5VDC	V _o : 115V-90~138V, 230V-170~260V, 380V-334~400V by VR, 1~120% by 1~6VDC I _{cc} : 20~100% by 1~4.8VDC
Overload protection	Range	100%~112%	100~105%
	Type	User adjustable continuous constant current limiting or constant current limiting with delay shutdown after 5 seconds. Re-power on to recover.	Constant current limiting, unit will shutdown after 5 seconds. Re-power on to recover.
Over voltage protection	Range	125%~140%	110%~144%
	Type	Shut down O/P voltage, re-power on to recover	
Withstand voltage		I/P-O/P: 3kVAC, I/P-FG: 2kVAC, O/P-FG: 0.5kVAC	I/P-O/P: 3kVAC, I/P-FG: 2kVAC, O/P-FG: 2kVAC
Working temperature		-30~+70°C (refer to output derating curve)	
Safety standards		UL62368-1, TUV BS EN/EN62368-1, EAC TP TC 004 approved	
EMC standards		BS EN/EN55032 class A, EN61000-3-2,3, EN61000-4-2,3,4,5,6,8,11, EN61000-6-2, EN61204-3	
Connection	Input	6P/13mm pitch terminal block with cover	
	Output	Bus bars	
Dimension (LxWxH) (mm)		540x 424x 83.5	

10KW RST-10000

Model No.	Output	Tol.	R&N	Effi.
RST-10000-24	24V, 0~400A	±1%	150mV	89%
RST-10000-36	36V, 0~276A	±1%	200mV	90%
RST-10000-48	48V, 0~210A	±1%	200mV	91%

15KW Coming Soon RST-15K

Model No.	Output	Tol.	R&N	Effi.
RST-15K-115	115V, 0~130.4A	±1%	1V	91%
RST-15K-230	230V, 0~69.4A	±1%	2V	92%
RST-15K-380	380V, 0~45A	±1%	4V	92.5%

Enclosed-PFC 10KW Programmable High Power



NEW



SHP-10K



Features

- 3 ϕ 3-wire/380VAC
- Wide voltage adjustment range 50~120%
- Built-in active PFC function
- High efficiency up to 97%
- Water or forced air cooling
- Built-in CANBus/Optional PMBus protocol/MODBus-RTU/RS-485
- Output voltage and constant current level programmable
- Active current sharing up to 4 units
- Built-in remote ON-OFF control / Auxiliary power/
- Alarm signal
- Protections: Short circuit / Overload / Over voltage /Over temperature / Fan fail
- 5 years warranty

General Specification (Please refer to www.meanwell.com for detail spec.)



Model No.	SHP-10K	
AC input voltage range	3 ϕ 3-wire/340~530VAC	
AC inrush current (max.)	Cold start, 60A at 400VAC, 70A at 480VAC	
DC adjustment range	Vo: 55V-39~57.6V, 115V-90~138V, 230V-170~260V, 380V-260~400V by VR or 50~120% by external 1~4.8VDC Icc: 20~100% by external 1~4.8VDC	
Overload protection	Range	100%~105%
	Type	Continuous constant current limiting, unit will shutdown after 5 seconds. Re-power on to recover.
Over voltage protection	Range	125%~145%
	Type	Shut down O/P voltage, re-power on to recover
Withstand voltage	I/P-O/P: 3.75kVAC, I/P-FG: 2kVAC, O/P-FG: 1.25kVAC	
Working temperature	-30~+70°C (refer to "Derating Curve")	
Safety standards	UL62368-1, CAN/CSA C22.2 No.62368-1,TUV BS EN/EN62368-1,EAC TP TC 004 approved	
EMC standards	BS EN/EN55032,EN55011 Class A;BS EN/EN61000-3-2,3;BS EN/EN61000-4-2,3,4,5,6,8,11	
Connection	Input	4P/11mm pitch terminal block with cover
	Output	Bus bars/
Dimension (LxWxH) (mm)	460x 211x 83.5	

10KW

SHP-10K

Model No.	Output	Tol.	R&N	Effi.
SHP-10K-55	55V, 0~150A	±1%	0.75V	95%
SHP-10K-115	115V, 0~87A	±1%	1.5V	96%
SHP-10K-230	230V, 0~46.2A	±1%	1.5V	96.5%
SHP-10K-380	380V, 0~30A	±1%	4.5V	97%

Conduction Cooled PFC 200~500W Slim Type

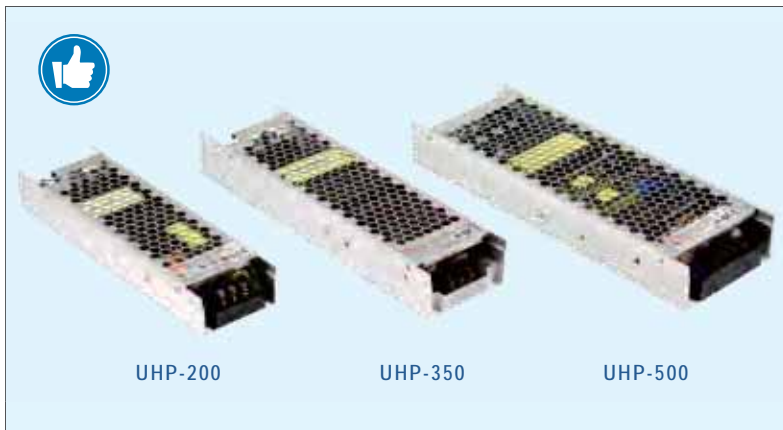

Features

- Universal AC input / Full range
- Withstand 300VAC surge input for 5 seconds
- Slim width and low profile
(26mm for UHP-200, 31mm for UHP-350/500)
- Built-in active PFC function
- 150% peak load capacity(100ms)
- Fanless and conduction-cooled design
- Protections: Short circuit / Overload / Over voltage / Over temperature
- Optional DC OK active signal and redundant function for UHP-200/350/500[R]
- LED indicator for power on
- 3 years warranty

General Specification (Please refer to www.meanwell.com for detail spec.)



Model No.	UHP-200	UHP-350	UHP-500
AC input voltage range	90~264VAC; 127~370VDC		
AC inrush current (max.)	Cold start, 40A at 115VAC, 80A at 230VAC	Cold start, 30A at 115VAC, 60A at 230VAC	
DC adjustment range	±5% rated output voltage		
Overload protection	Range	110%~140%	
	Type	Hiccup mode, auto-recovery	
Over voltage protection	Range	110%~140%	
	Type	Shut down O/P voltage, re-power on to recover	
Withstand voltage	I/P - O/P: 3.75kVAC, I/P - FG: 2kVAC, O/P - FG: 1.25kVAC		
Working temperature	-30~+70°C (refer to output derating curve)		-30~+70°C (refer to output derating curve)
Vibration	10~500Hz, 5G 10min./1cycle, 60min. each along X, Y, Z axes		
Safety standards	UL62368-1, TUV BS EN/EN62368-1, EN60335-1, GB4943, EAC TP TC 004, BSMI CNS14336-1 approved		
EMC standards	BS EN/EN55032 class B, EN61000-3-2,3, EN61000-4-2,3,4,5,6,8,11; GB9254, EN61000-6-2(EN50082-2); BSMI CNS13438		
Dimension (LxWxH)(mm)	194x 55x 26	220x 62x 31	233x 81x 31

200W UHP-200

Model No.	Output	Tol.	R&N	Effi.
UHP-200□-3.3	3.3V, 0~40A	±2%	150mV	89%
UHP-200□-4.2	4.2V, 0~40A	±2%	150mV	90%
UHP-200□-5	5V, 0~40A	±2%	200mV	91%
UHP-200□-12	12V, 0~16.7A	±1%	240mV	93%
UHP-200□-15	15V, 0~13.4A	±1%	240mV	94%
UHP-200□-24	24V, 0~8.4A	±1%	240mV	94%
UHP-200□-36	36V, 0~5.6A	±1%	240mV	94%
UHP-200□-48	48V, 0~4.2A	±1%	300mV	94%
UHP-200□-55	55V, 0~3.6A	±1%	360mV	94%

□=blank, R; blank: enclosed, R: DC OK signal, redundant function

350W UHP-350

Model No.	Output	Tol.	R&N	Effi.
UHP-350□-3.3	3.3V, 0~60A	±2%	150mV	88.5%
UHP-350□-4.2	4.2V, 0~60A	±2%	150mV	89%
UHP-350□-5	5V, 0~60A	±2%	200mV	90%
UHP-350□-12	12V, 0~29.2A	±1%	200mV	91%
UHP-350□-15	15V, 0~23.4A	±1%	200mV	92%

Model No.	Output	Tol.	R&N	Effi.
UHP-350□-24	24V, 0~14.6A	±1%	240mV	94%
UHP-350□-36	36V, 0~9.75A	±1%	240mV	94%
UHP-350□-48	48V, 0~7.3A	±1%	240mV	94%
UHP-350□-55	55V, 0~6.3A	±1%	300mV	94%

□=blank, R; blank: enclosed, R: DC OK signal, redundant function

500W UHP-500

Model No.	Output	Tol.	R&N	Effi.
UHP-500□-4.2	4.2V, 0~80A	±2%	200mV	89%
UHP-500□-5	5V, 0~80A	±2%	200mV	90%
UHP-500□-12	12V, 0~41.7A	±1%	200mV	94%
UHP-500□-15	15V, 0~33.4A	±1%	200mV	94%
UHP-500□-24	24V, 0~20.9A	±1%	240mV	94.5%
UHP-500□-36	36V, 0~13.9A	±1%	360mV	95%
UHP-500□-48	48V, 0~10.45A	±1%	360mV	95%
UHP-500□-55	55V, 0~8.9A	±1%	500mV	95%

□=blank, R; blank: enclosed, R: DC OK signal, redundant function

Note:48V and 55V types can be a PoE power source

Conduction Cooled PFC 750~1000W Slim Type



■ Features

- Universal AC input / Full range
- Withstand 300VAC surge input for 5 seconds
- Slim width and low profile(41mm)
- Built-in active PFC function
- Fanless and conduction-cooled design
- Protections: Short circuit / Overload / Over voltage / Over temperature
- Output voltage and current programmable(UHP-1000)
- Built-in remote ON-OFF control(UHP-1000)
- DC ok active signal
- LED indicator for power on
- 3 years warranty (UHP-750)
5 years warranty (UHP-1000)

■ General Specification (Please refer to www.meanwell.com for detail spec.)



Model No.	UHP-750	UHP-1000
AC input voltage range	90~264VAC; 127~370VDC	
AC inrush current (max.)	Cold start, 20A at 115VAC, 40A at 230VAC	
DC adjustment range	0~20% rated output voltage	
Overload protection	Range	105%~125%
	Type	Hiccup mode, auto-recovery
Over voltage protection	Range	120%~135%
	Type	Shut down O/P voltage, re-power on to recover
Withstand voltage	I/P-O/P: 3.75kVAC, I/P-FG: 2kVAC, O/P-FG: 1.25kVAC, 1 minute	
Working temperature	-30~+70°C (refer to output derating curve)	
Vibration	10~500Hz, 5G 10min./1cycle, 60min. each along X, Y, Z axes	
Safety standards	BS EN/EN62368-1, UL62368-1, EAC TP TC 004 approved; Design refer to BS EN/EN61558-1, EN60335-1 (by request)	
EMC standards	BS EN/EN55032 class B, EN61000-3-2,3, EN61000-4-2,3,4,5,6,8,11	
Dimension (LxWxH)(mm)	237x 100x 41	240x 115x 41

■ 750W UHP-750

Model No.	Output	Tol.	R&N	Effi.
UHP-750-12	12V, 0~60A	±1%	150mV	93.5%
UHP-750-24	24V, 0~31.3A	±1%	200mV	95%
UHP-750-36	36V, 0~21A	±1%	250mV	95%
UHP-750-48	48V, 0~15.7A	±1%	250mV	95%

■ 1000W UHP-1000

Model No.	Output	Tol.	R&N	Effi.
UHP-1000-12	12V, 0~80A	±1%	150mV	94%
UHP-1000-24	24V, 0~42A	±1%	240mV	95%
UHP-1000-36	36V, 0~28A	±1%	240mV	95.5%
UHP-1000-48	48V, 0~21A	±1%	300mV	96%

Note:48V output adjustable range 48~57V



Features

- Universal AC input / Full range
- Withstand 300VAC surge input for 5 seconds
- Slim width and low profile
(41mm for UHP-1500 / 60mm for UHP-2500)
- Built-in active PFC function
- Fanless and conduction-cooled design
- Protections: Short circuit / Overload / Over voltage / Over temperature
- Output voltage and current programmable
- Optional PMBus and CANBus protocol
- DC OK active signal
- LED indicator for power on
- 5 years warranty

General Specification (Please refer to www.meanwell.com for detail spec.)



Model No.	UHP-1500 UHP-1500-HV	UHP-2500
AC input voltage range	90~264VAC; 127~370VDC	
AC inrush current (max.)	Cold start, 60A at 230VAC	
DC adjustment range	0~20% rated output voltage	
Overload protection	Range	105%~125%
	Type	Constant current limiting with delay shutdown after 5 seconds, re-power on to recover
Over voltage protection	Range	125%~140%
	Type	Shut down O/P voltage, re-power on to recover
Withstand voltage	I/P-O/P: 3.75kVAC, I/P-FG: 2kVAC, O/P-FG: 1.25kVAC, 1 minute	
Working temperature	-30~+70°C (refer to output derating curve)	
Vibration	10~500Hz, 5G 10min./1cycle, 60min. each along X, Y, Z axes	
EMC standards	BS EN/EN55032 class B, EN61000-3-2,3, EN61000-4-2,3,4,6-2,5,6,8,11	
Safety standards	BS EN/EN62368-1, UL62368-1, EAC TP TC 004 approved; design refer to EN61558-1, EN60335-1 (by request)	
Dimension (LxWxH)(mm)	290x 140x 41	310x 140x 60

1500W UHP-1500

Model No.	Output	Tol.	R&N	Effi.
UHP-1500-24	24V, 0~62.5A	±1%	240mV	95%
UHP-1500-48	48V, 0~31.5A	±1%	350mV	96%
UHP-1500-115	115V, 0~13A	±1%	1150mV	95%
UHP-1500-230	230V, 0~7A	±1%	2300mV	96%
UHP-1500-380	380V, 0~4.5A	±1%	3800mV	96%
UHP-1500-380E	380V, 0~3.95A	±1%	3800mV	96%

2500W UHP-2500

Model No.	Output	Tol.	R&N	Effi.
UHP-2500-24	24V, 0~104.2A	±1%	300mV	95%
UHP-2500-36	36V, 0~69.4A	±1%	360mV	95.5%
UHP-2500-48	48V, 0~52.1A	±1%	480mV	96%

Note: 1. 48V output adjustable range 48~57V
2. UHP-1500-380E without CANBus/PMBus protocol



DPU-3200 Features

- Universal AC input/ Full Range
- High efficiency up to 94.5%
- Forced air cooling by building in DC fans
- Output voltage and constant current level programmable
- Active current sharing up to 16000W (5 units)
- Optional PMBus or CANBus protocol
- Protections: Short circuit / Over load / Over voltage / Over temperature
- Optional conformal coating
- 5 year warranty

PHP-3500 Features

- Universal AC input/ Full Range
- High efficiency up to 96%
- Fanless design, water-cooled power supply
- Slim and Low Profile (60mm)
- Output voltage and constant current level programmable
- OVC III operating altitude up to 2000 meters(PHP-3500-HV)
- Active current sharing up to 14000W, 4 units (24V & 48V models)
- Built-in PMBus or optional CANbus protocol
- Protections: Short circuit / Over load / Over voltage / Over temp.
- Optional cold plate for effortless implementation
- Optional conformal coating
- 5 year warranty

General Specification (Please refer to www.meanwell.com for detail spec.)



Model No.	DPU-3200	PHP-3500 PHP-3500-HV
AC input voltage range	90~264VAC; 127~370VDC	
AC inrush current (max.)	Cold start 55A/230VAC	Cold start 80A/230VAC
DC adjustment range	24V: 23.5~30V; 48V: 47.5~58.8V	24V: 24~28.8V; 48V: 48~57.6V 115V: 110~160V; 230V: 170~260V; 380V: 260~400V
Overload protection	Range	105~115% rated output power
	Type	Constant current limiting, shut down O/P voltage 5 sec. after O/P voltage is down low, re-power on to recover.
Over voltage protection	Range	24V: 31.5~37.5V; 48V: 63~75V 24V: 30~36V; 48V: 60~72V 115V: 168~200V; 230V: 273~320V; 380V: 413~460V
	Type	Shut down O/P voltage, re-power on to recover
Withstand voltage	I/P-O/P: 3KVAC; I/P-FG: 2KVAC; O/P-FG: 1.5KVAC	I/P-O/P: 3KVAC; I/P-FG: 2KVAC; O/P-FG: 1.25KVAC
Working temperature	-30~+70°C (refer to "De-rating curve")	-30~+70°C Baseplate Temperature (refer to "De-rating curve")
Vibration	10 ~ 500Hz, 2G 10min./1cycle, 60min. each along X, Y, Z axes	
Safety standards	UL62368-1, TUV BS EN/EN62368-1, EAC TP TC 004 approved	UL62368-1, TUV BS EN/EN62368-1, EAC TP TC 004 approved; Design refer to BS EN/EN61558-1, EN60335-1
EMC standards	BS EN/EN55032/EN55011 Conduction Class B, Radiation Class A; EN61000-3-2,3; EN61000-4-2, 3, 4, 6, 8, 11; EN-61000-6-2, EAC TP TC 020	
Connection	Bus Bar	Terminal
Dimension (LxWxH)(mm)	325.8 x 107 x 41	380 x 141.4 x 60

3200W DPU-3200

Model No.	Output	Tol.	R&N	Effi.
DPU-3200-24	24V, 0~133A	±1%	300mV	93.5%
DPU-3200-48	48V, 0~67A	±1%	480mV	94.5%

3500W PHP-3500

Model No.	Output	Tol.	R&N	Effi.
PHP-3500-24	24V, 0~145A	±1%	300mV	95%
PHP-3500-48	48V, 0~73A	±1%	480mV	96%
PHP-3500-115	115V, 0~25.2A	±1%	1150mV	95%
PHP-3500-230	230V, 0~15.2A	±1%	2300mV	95.5%
PHP-3500-380	380V, 0~9.2A	±1%	3800mV	96%

As increases in energy costs and demands to reduce fossil-based emissions are accelerating a worldwide call for clean energy and efficient power consumption, the DC House is far beyond a concept but necessary infrastructure. MEAN WELL is proud to introduce a new DC centralized bus for indoor device applications to reduce power loss issue.

With nearly four decades of experience in power supply design and manufacturing, MEAN WELL provides power solutions for DC centralized bus and DC lighting applications with complete enclosed type and DC to DC LED driver product portfolios. The DC centralized bus is easily integrated into a renewable energy system to reduce power consumption and total cost.

Please refer to the below diagram for a brand new "DC WORLD".

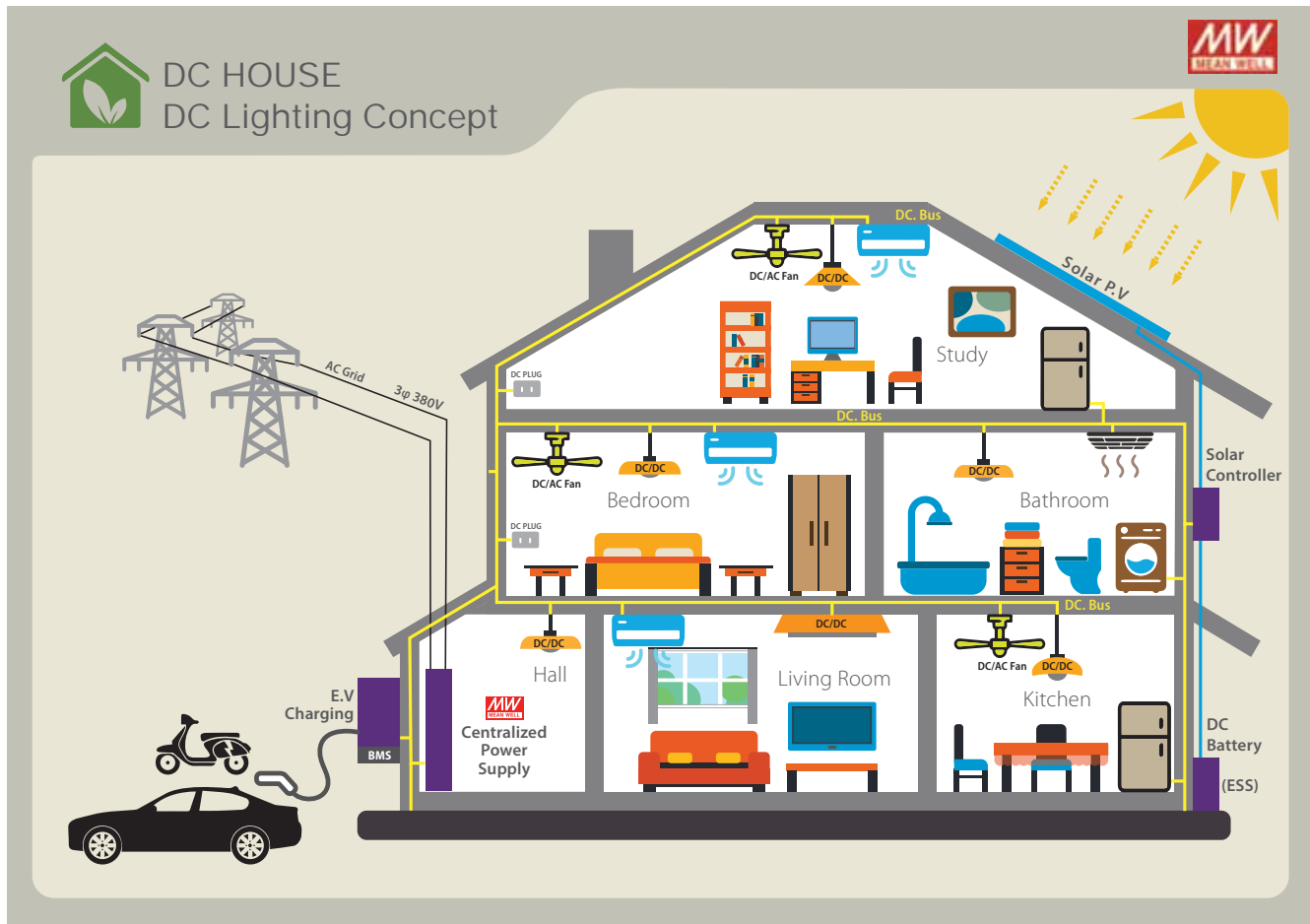

DC Centralized Bus for Lighting Application Selection Guide

Voltage type	Front-end (AC to DC Enclosed type)	Back-end (DC to DC LED driver)	Dimming function
Low Voltage bus (48V)	UHP-1500(1Ø3W) RST-5000/10000 (3Ø4W) SHP-10K(3Ø3W) <i>Under Development</i>	NLDD-H series LDDS-HWB series LDD-H-DA series	·PWM ·0-10V ·DALI
High Voltage bus (380V)	UHP-1500(1Ø3W) <i>Releasing in 2021,Q4</i> RST-7K5/15K (3Ø4W) <i>Under Development</i> SHP-10K(3Ø3W) <i>Under Development</i>	NHDD series <i>Releasing in 2021,Q4</i>	·PWM ·Dim with DAP-04 for DALI system

Note: For detail LED Driver specification, please refer our LED power supply catalog.



Features

- Constant Current mode output
- For DC 380V BUS lighting luminaire
- Driver on Board (DoB) Solution available
- Plastic housing and Fully encapsulated
- Built-in PWM and Remote ON/OFF control
- Protections: short circuit/over temperature
- 5 years warranty

General Specification (Please refer to www.meanwell.com for detail spec.)

Output current accuracy	±5% at 380VDC input (Typical)	
PWM dimming & ON/OFF control	Remote ON/OFF	Leave open if not used • Power ON with dimming: DIM ~ -Vin >2.5~5VDC or open circuit • Power OFF: DIM ~ -Vin <0.8VDC or short
	PWM frequency	100~1KHz
Short circuit	Hiccup mode, recovers automatically after fault condition is removed	
Over temperature protection	Tcase>85 ±5 ,derate power automatically	
Working temperature	-30 ~ +85 (Please refer to "OUTPUT LOAD vs TEMPERATURE" section)	
EMC standards	BS EN55015, BS EN61547, BS EN61000-4-2,3,4,6,8	
Operating case temp. (max.)	<85°C	
Dimension (LxWxH)(mm)	32.1x 20.5x 12.5mm	

Model No.	Input	Output Voltage	Output Current	Io Tol.	Efficiency
NHDD-40-100□	360~400V	355V (typical)	100mA	±15%	95%

□ = Blank, W ; Blank: Pin style, W: Wire style

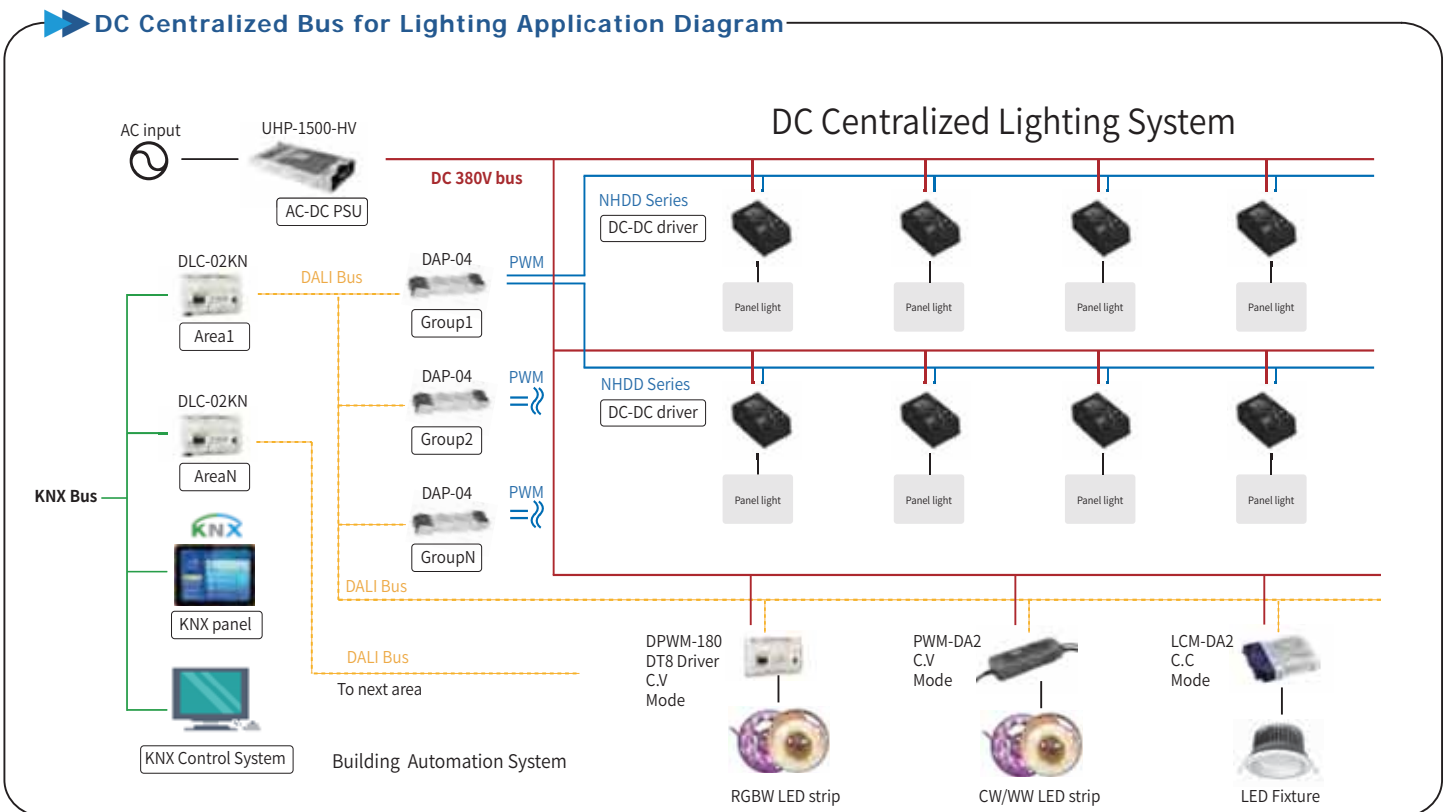



■ Features

- Universal AC input / Full range
- Built-in active PFC function
- Protections:
 - Short circuit / Overload / Over voltage / Over temperature
- **Output voltage programmable**
- Forced air cooling by built-in DC fan (except for SPV-150)
- 3 years warranty

■ General Specification (Please refer to www.meanwell.com for detail spec.)



Model No.	SPV-150	SPV-300
AC input voltage range	88~264VAC; 124~370VDC	
AC inrush current (max.)	Cold start, 45A at 230VAC	
DC adjustment range	Vo: -15%~+10% by VR or to 20%~110% of rated output voltage by 1~5.5VDC external control signal	
Overload protection	Range	105%~150%
	Type	constant current limiting, auto-recovery
Over voltage protection	Range	115%~140%
	Type	shut down O/P voltage, re-power on to recover
Withstand voltage	I/P - O/P: 3kVAC, I/P-FG: 2kVAC, O/P-FG: 0.5kVAC	
Working temperature	-20~+65°C (refer to "De-rating curve")	
Safety standards	UL62368-1, TUV BS EN/EN62368-1, EAC TP TC 004 approved	
EMC standards	BS EN/EN55032 class B, EN61000-3-2,3, EN61000-4-2,3,4,5,6,8,11, EAC TP TC 020	
Dimension (LxWxH) (mm)	215x 115x 50	

■ 150W SPV-150

Model No.	Output	Tol.	R&N	Effi.
SPV-150-12	12V, 0~12.5A	±1%	150mV	82%
SPV-150-24	24V, 0~6.25A	±1%	150mV	83%
SPV-150-48	48V, 0~3.125A	±1%	240mV	83%

■ 300W SPV-300

Model No.	Output	Tol.	R&N	Effi.
SPV-300-12	12V, 0~25A	±1%	150mV	83.5%
SPV-300-24	24V, 0~12.5A	±1%	150mV	85.0%
SPV-300-48	48V, 0~6.25A	±1%	240mV	86.5%

► Output Voltage Programmable for SPV series

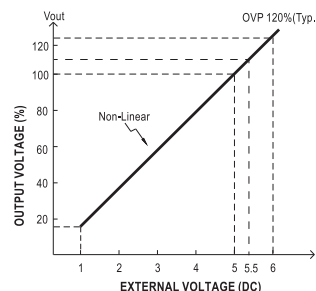
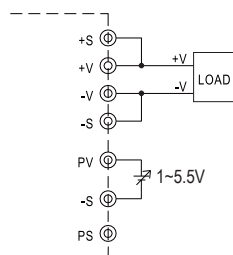

Enclosed-Redundancy Module 20A&40A



■ Features

- Output current **20A & 40A**
- Support **1+1 and N+1 redundancy** system
- Suitable for redundancy operation of 5V/12V/24V/48V system
- 2 channels input and 1 output
- **-40~+80°C** ultra wide operating temperature
- **2 dry relay contact** for monitoring output status, and LED indicator for input failure alarm
- 3 years warranty

DRDN20/40 series, DIN rail type modules are available on P.40

■ General Specification (Please refer to www.meanwell.com for detail spec.)



Model No.	ERDN20 [24]				ERDN40 [24]				
	5	12	24	48	12	24	48		
Input	DC input voltage range	4.5~6Vdc	9~14Vdc	19~29Vdc	36~60Vdc	9~14Vdc	19~29Vdc	36~60Vdc	
	Rated current	0~20A per input continuous				0~40A per input continuous			
	Peak current	0~30A per input 5 sec				0~60A per input 5 sec			
	Voltage drop (Vin-Vout)	0.2~0.5Vdc max.							
Output	Reverse voltage (max.)	15Vdc	40Vdc	40Vdc	65Vdc	40Vdc	40Vdc	65Vdc	
	Rated current	20A				40A			
	Peak current	30A, 5 sec.				60A, 5 sec.			
General	Standby power losses	1.5W Typ.							
	Relay contact	2 dry relay contact, 30Vdc resistive load for each channel							
	Input voltage alarm	Voltage range	<4 or >6.5V	<8.5V or >14.7V	<18V or >31V	<34.2V or >63V	<8.5V or >14.7V	<18V or >31V	<34.2V or >63V
		LED display	Green: OK, dark: input voltage failure						
	Working temperature	-40~+80°C (refer to output derating curve)							
	Protections	Overload or short circuit, <30A for 5 sec. no damage							
	Cooling	Free air convection							
	Safety standards	UL62368-1, EAC TP TC 004 approved							
	EMC standards	BS EN/EN55032 class B, EN61000-4,2,3,4,5,6,8							
	Connection	Screw terminal: I/P: 4 poles (Vin1 and Vin2 +,-), O/P: 2 poles (Vo+/Vo-); wafer connector: 4 pin (Alarm1 and Alarm2 dry relay contact)							
Dimension (LxWxH)(mm)	82x 99x 36				97x 99x 36				

■ 20A ERDN20

Model No.	Nominal Voltage	Input / Output Current
ERDN20 [24]	5V, 12V, 24V, 48V	2x10A / 20A
□ = 5, 12, 24, 48		

■ 40A ERDN40

Model No.	Nominal Voltage	Input / Output Current
ERDN40 [24]	12V, 24V, 48V	2x20A / 40A
□ = 12, 24, 48		

Example of Application

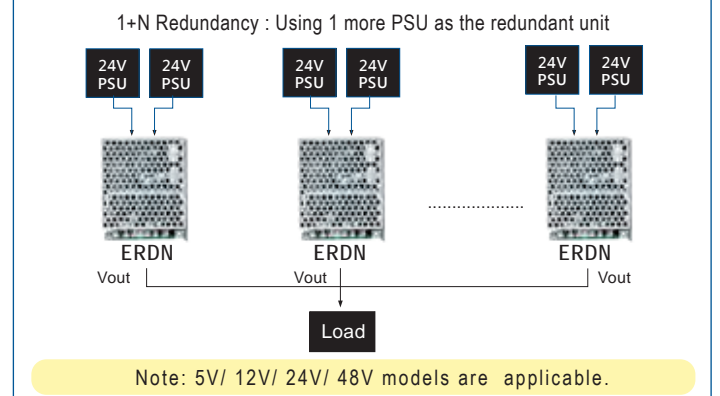

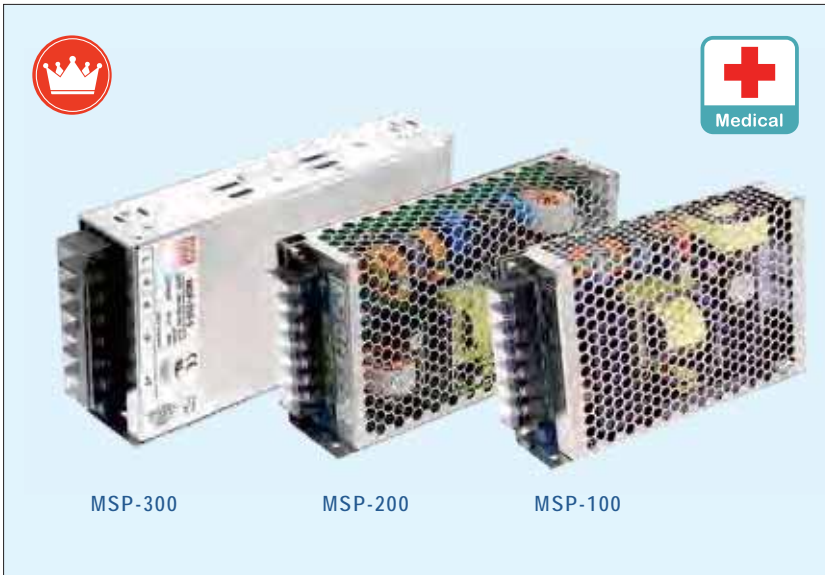

Features

- Universal AC input / Full range
- **Medical safety approved (2xMOOP)**
- Withstand 300VAC surge input for 5 seconds
- Built-in active PFC function
- Protections: Short circuit / Overload / Over voltage / Over temperature
- 1U low profile
- Built-in constant current limiting circuit
- Built-in remote sense function (MSP-200/300)
- No load power consumption <0.5W
- Built-in remote ON/OFF control
- Built-in 5V/0.3A standby output (MSP-200/300)
- Built-in DC OK signal (MSP-300)
- LED indicator for power on
- **5 years warranty**

General Specification (Please refer to www.meanwell.com for detail spec.)



Model No.	MSP-100	MSP-200	MSP-300
AC input voltage range	85~264VAC; 120~370VDC		
Leakage current	<300μA		<450μA
AC inrush current (max.)	Cold start, 65A at 230VAC	Cold start, 70A at 230VAC	
DC adjustment range	±15% rated output voltage		
Overload protection	Range	105%~135%	
	Type	Constant current limiting, auto-recovery	
Over voltage protection	115%~145%		
Withstand voltage	I/P-O/P: 4kVAC, I/P-FG: 2kVAC, O/P-FG: 0.5kVAC, 1 minute		
Working temperature	-40~+60°C	-40~+70°C (refer to output derating curve)	
Safety standards	ANSI/AAMI ES60601-1, BS EN60601-1, EAC TP TC 004 approved		
EMC standards	BS EN/EN55011 class B, EN61000-4-2,3,4,5,6,8,11, EN61000-3-2,3, EN60601-1-2; EAC TP TC 020		
Connection	7P / 9.5mm pitch terminal block with cover		7P / 11mm pitch terminal block with cover
Dimension (LxWxH)(mm)	159x 97x 38	199x 98x 38	199x 105x 41

100W MSP-100

Model No.	Output	Tol.	R&N	Effi.
MSP-100-3.3	3.3V, 0~20A	+2.5%, -3.5%	80mV	78.0%
MSP-100-5	5V, 0~17A	+2.5%, -3.5%	80mV	83.0%
MSP-100-7.5	7.5V, 0~13.5A	±2.5%	100mV	84.0%
MSP-100-12	12V, 0~8.5A	±1.5%	120mV	87.5%
MSP-100-15	15V, 0~7A	±1.5%	150mV	88.0%
MSP-100-24	24V, 0~4.5A	±1.5%	150mV	88.5%
MSP-100-36	36V, 0~2.9A	±1.5%	200mV	89.0%
MSP-100-48	48V, 0~2.2A	±1.5%	240mV	90.0%

200W MSP-200

Model No.	Output	Tol.	R&N	Effi.
MSP-200-3.3	3.3V, 0~40A	±2%	80mV	80.0%
MSP-200-5	5V, 0~35A	±2%	90mV	84.0%
MSP-200-7.5	7.5V, 0~26.7A	±2%	100mV	86.0%

Model No.	Output	Tol.	R&N	Effi.
MSP-200-12	12V, 0~16.7A	±1%	120mV	88.0%
MSP-200-15	15V, 0~13.4A	±1%	150mV	88.0%
MSP-200-24	24V, 0~8.4A	±1%	150mV	88.0%
MSP-200-36	36V, 0~5.7A	±1%	250mV	89.0%
MSP-200-48	48V, 0~4.3A	±1%	250mV	89.0%

300W MSP-300

Model No.	Output	Tol.	R&N	Effi.
MSP-300-3.3	3.3V, 0~60A	±2.5%	80mV	80.0%
MSP-300-5	5V, 0~60A	±2%	90mV	82.0%
MSP-300-7.5	7.5V, 0~40A	±2%	100mV	86.0%
MSP-300-12	12V, 0~27A	±1%	120mV	88.0%
MSP-300-15	15V, 0~22A	±1%	150mV	88.0%
MSP-300-24	24V, 0~14A	±1%	150mV	87.0%
MSP-300-36	36V, 0~9A	±1%	250mV	88.0%
MSP-300-48	48V, 0~7A	±1%	250mV	89.0%



Features

- Universal AC input / Full range
- Medical safety approved (2xMOOP) for MSP-450/600
Medical safety approved (2xMOPP) for MSP-1000
- Withstand 300VAC surge input for 5 seconds
- Built-in active PFC function
- Protections: Short circuit / Overload / Over voltage / Over temperature
- Built-in constant current limiting circuit
- Built-in remote sense function
- No load power consumption <0.6W for MSP-450; <0.8W for MSP-600/1000; <0.75W for MSP-1000
- Built-in current sharing (MSP-600-24/36/48; MSP-1000)
- Built-in remote ON/OFF control
- Built-in 5V/0.3A standby output
- Built-in DC OK signal
- LED indicator for power on
- 5 years warranty

General Specification (Please refer to www.meanwell.com for detail spec.)



Model No.	MSP-450	MSP-600	MSP-1000
AC input voltage range	85~264VAC; 120~370VDC		90~264VAC; 127~370VDC
Leakage current	<300μA		
AC inrush current (max.)	Cold start, 70A at 230VAC	Cold start, 80A at 230VAC	Cold start, 40A at 230VAC
DC adjustment range	±15% rated output voltage		-8%~+17% rated output voltage
Overload protection	Range	105%~135%	
	Type	Constant current limiting, auto-recovery	
Over voltage protection	115%~145%		120%~137%
Withstand voltage	I/P-O/P: 4kVAC, I/P-FG: 2kVAC, O/P-FG: 0.5kVAC, 1 minute		I/P-O/P: 4.5kVAC, I/P-FG: 2kVAC, O/P-FG: 1.5kVAC, 1 minute
Working temperature	-40~+70°C (refer to output derating curve)		
Safety standards	ANSI/AAMI ES60601-1, BS EN60601-1, EAC TP TC 004 approved		
EMC standards	BS EN/EN55011 class B for MSP-450/600, EN55032 class A for MSP-1000, EN61000-4-2,3,4,5,6,8,11, EN61000-3-2,3, EN60601-1-2		
Connection	3+6P / 10 & 11mm pitch terminal block with cover		
Dimension (LxWxH)(mm)	218x 105x 41	218x 105x 63.5	

450W MSP-450

Model No.	Output	Tol.	R&N	Effi.
MSP-450-3.3	3.3V, 0~90A	±2%	80mV	80.0%
MSP-450-5	5V, 0~90A	±2%	80mV	83.0%
MSP-450-7.5	7.5V, 0~60A	±2%	100mV	86.5%
MSP-450-12	12V, 0~37.5A	±1%	120mV	88.0%
MSP-450-15	15V, 0~30A	±1%	150mV	89.0%
MSP-450-24	24V, 0~18.8A	±1%	150mV	88.0%
MSP-450-36	36V, 0~12.5A	±1%	240mV	89.0%
MSP-450-48	48V, 0~9.5A	±1%	240mV	89.5%

600W MSP-600

Model No.	Output	Tol.	R&N	Effi.
MSP-600-3.3	3.3V, 0~120A	±2%	120mV	78.5%
MSP-600-5	5V, 0~120A	±2%	150mV	82.0%
MSP-600-7.5	7.5V, 0~80A	±2%	150mV	86.0%

Model No.	Output	Tol.	R&N	Effi.
MSP-600-12	12V, 0~53A	±1%	150mV	88.0%
MSP-600-15	15V, 0~43A	±1%	150mV	88.0%
MSP-600-24	24V, 0~27A	±1%	150mV	88.0%
MSP-600-36	36V, 0~17.5A	±1%	200mV	89.0%
MSP-600-48	48V, 0~13A	±1%	240mV	89.0%

1000W MSP-1000

Model No.	Output	Tol.	R&N	Effi.
MSP-1000-12	12V, 0~80A	±2%	150mV	91.5%
MSP-1000-15	15V, 0~64A	±1.5%	150mV	92.0%
MSP-1000-24	24V, 0~42A	±1%	200mV	93.0%
MSP-1000-48	48V, 0~21A	±1%	250mV	94.0%



Features

- Universal AC input / Full range
- Installed on DIN rail TS-35 / 7.5 or 15
- Protections: Short circuit / Overload / Over voltage
- No load power consumption <0.75W (<1W for MDR-100)
- LED indicator for power on
- Built-in active PFC and over temp. protection (MDR-100)
- Class I, Div 2 Hazardous Locations T4(MDR-40/60)
- DC OK signal output (MDR-10/20);
DC OK relay contact (MDR-40/60/100)
- Cooling by free air convection
- DC output voltage adjustable (MDR-20~100)
- 3 years warranty

General Specification (Please refer to www.meanwell.com for detail spec.)

Model No.	MDR-10	MDR-20	MDR-40	MDR-60	MDR-100
AC input voltage range	85~264VAC; 120~370VDC				
AC inrush current	Cold start, 35A at 115VAC, 70A at 230VAC	Cold start, 20A at 115VAC, 40A at 230VAC	Cold start, 30A at 115VAC, 60A at 230VAC		
DC adjustment range	Fixed	±10% rated output voltage	0~+20% rated output voltage		
Overload protection	>105% hiccup mode, auto-recovery	105%~160% constant current limiting, auto-recovery	105%~150% constant current limiting, auto-recovery		
Over voltage protection	115%~135% rated output voltage		125%~150% rated output voltage		
Setup, rise, hold up time	500ms, 30ms, 120ms	500ms, 30ms, 50ms		3000ms, 50ms, 50ms	
Withstand voltage	I/P-O/P:3kVAC, I/P-FG:2kVAC, 1minute				
Working temperature	-20~+70°C (refer to output derating curve)				-10~+60°C
DC OK signal	Open collector		Relay contact		
Safety standards	UL508, TUV BS EN/EN62368-1, EAC TP TC 004, BSMI CNS14336-1, AS/NZS 60950.1 approved; MDR-40/60 also approved for UL62368-1, ANSI/ISA 12.12.01-2013 Class I, Div. 2 Group A, B, C, D Hazardous Locations T4				
EMC standards	BS EN/EN55032 class B, EN61000-3-2,3, EN61000-4-2,3,4,5,6,8,11, EN61204-3, EN61000-6-2 heavy industry level (MDR-40/60/100), CNS13438				
Connection	I/P: 3 poles, O/P: 3 poles screw DIN terminal		IP: 3 poles, O/P: 6 poles screw DIN terminal		
Dimension (WxHxD)(mm)	22.5x90x100		40x90x100		55x90x100

10W

Model No.	Output	Tol.	R&N	Effi.
MDR-10-5	5V, 0~2.0A	±5%	80mV	77%
MDR-10-12	12V, 0~0.84A	±3%	120mV	81%
MDR-10-15	15V, 0~0.67A	±3%	120mV	81%
MDR-10-24	24V, 0~0.42A	±2%	150mV	84%

20W

Model No.	Output	Tol.	R&N	Effi.
MDR-20-5	5V, 0~3.0A	±2%	80mV	76%
MDR-20-12	12V, 0~1.67A	±1%	120mV	80%
MDR-20-15	15V, 0~1.34A	±1%	120mV	81%
MDR-20-24	24V, 0~1.00A	±1%	150mV	84%

40W

Model No.	Output	Tol.	R&N	Effi.
MDR-40-5	5V, 0~6.00A	±2%	80mV	78%
MDR-40-12	12V, 0~3.33A	±1%	120mV	86%

Model No.	Output	Tol.	R&N	Effi.
MDR-40-24	24V, 0~1.70A	±1%	150mV	88%
MDR-40-48	48V, 0~0.83A	±1%	200mV	88%

60W

Model No.	Output	Tol.	R&N	Effi.
MDR-60-5	5V, 0~10.0A	±2%	80mV	78%
MDR-60-12	12V, 0~5.00A	±1%	120mV	86%
MDR-60-24	24V, 0~2.50A	±1%	150mV	88%
MDR-60-48	48V, 0~1.25A	±1%	200mV	87%

100W

Model No.	Output	Tol.	R&N	Effi.
MDR-100-12	12V, 0~7.5A	±1%	120mV	83%
MDR-100-24	24V, 0~4.0A	±1%	150mV	86%
MDR-100-48	48V, 0~2.0A	±1%	200mV	87%



HDR-15

HDR-30

HDR-60

Features

- Isolation **Class II**
- Universal AC input / Full range (277VAC operational)
- No load power consumption <0.3W
- **Compact size with 1SU~4SU width**
- **Class 2 power unit / Pass LPS**
- **Over voltage category III**
- Protections: Short circuit / Overload / Over voltage
- Can be installed on DIN rail TS-35 / 7.5 or 15
- Cooling by free air convection
- DC output voltage adjustable
- LED indicator for power on
- Suitable for building automation and control of household appliance
- 3 years warranty

General Specification (Please refer to www.meanwell.com for detail spec.)



Model No.	HDR-15	HDR-30	HDR-60
AC input voltage range	85~264VAC (277VAC operational); 120~370VDC (390VDC operational)		
AC inrush current (max.)	Cold start, 45A at 230VAC		Cold start, 60A at 230VAC
DC adjustment range	5V: 4.5~5.5V, 12V: 10.8~13.8V, 15V: 13.5~18V, 24V: 21.6~29V, 48V: 43.2~55.2V		
Overload protection	Range	110%~145%	105%~160%
	Type	Hiccup mode when output voltage <50%, constant current limiting within 50~100% rated output voltage, auto-recovery	
Over voltage protection	Range	115%~150% rated output voltage	
	Type	Shut off, clamp by zener diode	Shut down, re-power on to recover
Withstand voltage	I/P-O/P: 4kVAC		
Working temperature	-30~+70°C (refer to output load derating curve)		
Vibration	10~500Hz, 2G 10 min./1 cycle, period for 60 min. each along X, Y, Z axes		
Safety standards	UL62368-1, UL508, TUV BS EN/EN61558-2-16, BS EN62368-1, EAC TP TC 004, BSMI CNS14336-1 approved		
EMC standards	BS EN/EN55032 class B, EN61000-3-2,3, EN61000-6-2, EN61000-4-2,3,4,5,6,8,11, EN61204-3		
Connection	I/P and O/P: 2 poles screw DIN terminal		I/P: 2 poles, O/P: 4 poles screw DIN terminal
Dimension (WxHxD)(mm)	17.5x 90x 54.5	35x 90x 54.5	52.5x 90x 54.5

15W		HDR-15		
Model No.	Output	Tol.	R&N	Effi.
HDR-15-5	5V, 0~2.40A	±2%	80mV	80%
HDR-15-12	12V, 0~1.25A	±1%	120mV	85%
HDR-15-15	15V, 0~1.00A	±1%	120mV	85.5%
HDR-15-24	24V, 0~0.63A	±1%	150mV	86%
HDR-15-48	48V, 0~0.32A	±1%	240mV	87%

60W		HDR-60		
Model No.	Output	Tol.	R&N	Effi.
HDR-60-5	5V, 0~6.5A	±2%	80mV	85%
HDR-60-12	12V, 0~4.5A	±1%	120mV	88%
HDR-60-15	15V, 0~4.0A	±1%	120mV	89%
HDR-60-24	24V, 0~2.5A	±1%	150mV	90%
HDR-60-48	48V, 0~1.25A	±1%	240mV	91%

30W		HDR-30		
Model No.	Output	Tol.	R&N	Effi.
HDR-30-5	5V, 0~3.0A	±2%	80mV	82%
HDR-30-12	12V, 0~2.0A	±1%	120mV	88%
HDR-30-15	15V, 0~2.0A	±1%	120mV	89%
HDR-30-24	24V, 0~1.5A	±1%	150mV	89%
HDR-30-48	48V, 0~0.75A	±1%	240mV	90%

HDR vs. MDR

Difference Series	Casing Type	Protection Classes	Over Voltage Category	Working Temp.
HDR	Step Shape	Class II	OVC III	-30~+70°C
MDR	Ultra Slim	Class I	-----	-20~+70°C



HDR-100

HDR-150

Features

- Isolation **Class II**
- Universal AC input / Full range (277VAC operational)
- No load power consumption <0.3W
- **Compact size with 4SU~6SU width**
- **Class 2 power unit / Pass LPS** (HDR-100 only)
- **Over voltage category III**
- Protections: Short circuit / Overload / Over voltage
- Can be installed on DIN rail TS-35 / 7.5 or 15
- Cooling by free air convection
- DC output voltage adjustable
- LED indicator for power on
- Suitable for building automation and control of household appliance
- 3 years warranty

General Specification



Model No.	HDR-100 □		HDR-150
AC input voltage range	85~264VAC (277VAC operational); 120~370VDC (390VDC operational)		
AC inrush current (max.)	Cold start, 70A at 230VAC		
DC adjustment range	HDR-100 12V: 12~13V, 15V: 15~17V, 24V: 24~25.5V, 48V: 48~48.7V HDR-100-N 12V: 12~13.8V, 15V: 13.8~18V, 24V: 21.6~29V, 48V: 43.2~55.2V		12V: 10.8~13.8V 15V: 13.8~18V 24V: 21.6~29V 48V: 43.2~55.2V
	Overload protection	Range HDR-100: 102%~110%; HDR-100-xxN: 105%~150%	105%~135%
Over voltage protection	Range	125%~155% rated output voltage	
	Type	Shut down, re-power on to recover	
Withstand voltage	I/P-O/P: 3kVAC		
Working temperature	-30~+70°C (refer to output load derating curve)		
Vibration	10~500Hz, 2G 10 min./1 cycle, period for 60 min. each along X, Y, Z axes		
Safety standards	UL62368-1, UL508, TUV BS EN/EN61558-2-16, IEC62368-1, BSMI CNS14336, AS/NZS60950.1, TPTC004 approved		UL62368-1, UL61010, TUV BS EN/EN61558-2-16, IEC62368-1, TPTC004 approved
EMC standards	BS EN/EN55032 class B, EN61000-3-2,3, EN61000-6-2, EN61000-4-2,3,4,5,6,8,11, CNS13438, EN61204-3		
Connection	I/P: 2 poles, O/P: 4 poles screw DIN terminal		
Dimension (WxHxD)(mm)	70x 90x 54.5		105x 90x 54.5

100W		HDR-100		
Model No.	Output	Tol.	R&N	Effi.
HDR-100-12	12V, 0~7.1A	±2%	120mV	88%
HDR-100-12N	12V, 0~7.5A	±2%	120mV	88%
HDR-100-15	15V, 0~6.13A	±1%	120mV	89%
HDR-100-15N	15V, 0~6.5A	±1%	120mV	89%
HDR-100-24	24V, 0~3.83A	±1%	150mV	90%
HDR-100-24N	24V, 0~4.2A	±1%	150mV	90%
HDR-100-48	48V, 0~1.92A	±1%	240mV	90%
HDR-100-48N	48V, 0~2.1A	±1%	240mV	90%

150W		HDR-150		
Model No.	Output	Tol.	R&N	Effi.
HDR-150-12	12V, 0~11.3A	±2%	100mV	89%
HDR-150-15	15V, 0~9.5A	±1%	120mV	89.5%
HDR-150-24	24V, 0~6.25A	±1%	150mV	90.5%
HDR-150-48	48V, 0~3.2A	±1%	200mV	90.5%

HDR-100: 92W max., pass LPS
HDR-100-xxN: 100W max., non-LPS with a wide output adjustable range



Features

- High efficiency up to **94%**
- Universal AC input / Full range (SDR-75/120/240/480); AC input 180~264VAC only (SDR-960)
- **Complete functions:**
 - ◆ **130~150% peak load** capability by series
 - ◆ **Current sharing** up to **3840W** (7+1 for SDR-480P, 3+1 for SDR-960)
 - ◆ Built-in **DC OK relay contact** (except for SDR-75)
 - ◆ Comply with **SEMIF47** (SDR-75~960)
- Protections: Short circuit / Overload / Over voltage / Over temperature
- Cooling by free air convection
- DC output voltage adjustable
- Installed on DIN rail TS-35 / 7.5 or 15
- UL508(industrial control equipment) approved
- EN61000-6-2(EN50082-2) industrial immunity level
- 3 years warranty

General Specification (Please refer to www.meanwell.com for detail spec.)

Model No.	SDR-75	SDR-120	SDR-240	SDR-480□	SDR-960
AC input voltage range	88~264VAC; 124~370VDC			90~264VAC; 127~370VDC	180~264VAC; 254~370VDC
AC inrush current (max.)	Cold start, 50A at 230VAC	Cold start, 70A at 230VAC	Cold start, 55A at 230VAC	Cold start, 80A at 230VAC	Cold start, 50A at 230VAC
DC adjustment range	12V: 12~14V (only for SDR-75/120), 24V: 24~28V, 48V: 48~55V				
Overload protection	Normally works within 110%~150% rated output power for 3 seconds and then shut down output voltage with auto-recovery (re-power on to recover for SDR-75)				Normally works within 105%~130% rated output power for 3 seconds and then shut down o/p voltage with auto-recovery after 30 seconds if the peak load condition is removed
	>150% rated power or short circuit, constant current limiting with auto-recovery within 2 seconds and may cause to shut down if over 2 seconds				Constant current limiting within 130%~150% rated output power for more than 3 seconds and then shut down o/p voltage, re-power on to recover
Over voltage protection	Range	14~17V for 12V model(SDR-75/120), 29~33V for 24V model, 56~65V for 48V model			
	Type	Shut down o/p voltage, re-power on to recover		Shut down o/p voltage with auto-recovery, or re-power on to recover	
Over temperature protection	Re-power on to recover		Recovers automatically after temperature goes down		
Withstand voltage	I/P-O/P:3kVAC, I/P-FG:1.5kVAC, O/P-FG:0.5kVAC, O/P-DC OK:0.5kVAC (except for SDR-75)				
Working temperature	-30~+70°C		-25~+70°C (refer to output derating curve)		-30~+70°C
Safety standards	UL508, TUV BS EN/EN62368-1, EAC TP TC 004, BSMI CNS14336-1(SDR-120/240/480/960) approved				
EMC standards	BS EN/EN55011(SDR-120/240/480), EN55032 class B, EN61000-3-2,3, EN61000-4-2,3,4,5,6,8,11, EAC TP TC 020, EN61000-6-2 (EN50082-2), EN61204-3; SEMI (SDR-75/120/240/480)				
Connection (screw DIN terminal)	I/P: 3 poles, O/P: 4 poles		I/P: 3 poles, O/P: 6 poles	I/P: 3 poles, O/P: 8 poles	I/P:3 poles, O/P: 6 poles
Dimension (WxHxD)(mm)	32x125.2x102	40x125.2x113.5	63x125.2x113.5	85.5x125.2x128.5	110x125.2x150

75W



Model No.	Output	Tol.	R&N	Effi.
SDR-75-12	12V, 0~6.3A	±1.0%	100mV	88.5%
SDR-75-24	24V, 0~3.2A	±1.0%	100mV	89.0%
SDR-75-48	48V, 0~1.6A	±1.0%	120mV	90.0%

120W



Model No.	Output	Tol.	R&N	Effi.
SDR-120-12	12V, 0~10A	±1.0%	100mV	89.0%
SDR-120-24	24V, 0~ 5A	±1.0%	100mV	91.0%
SDR-120-48	48V, 0~2.5A	±1.0%	120mV	90.5%

240W



Model No.	Output	Tol.	R&N	Effi.
SDR-240-24	24V, 0~10A	±1.0%	50mV	94%
SDR-240-48	48V, 0~5A	±1.0%	50mV	94%

480W



Model No.	Output	Tol.	R&N	Effi.
SDR-480□-24	24V, 0~20A	±1.2%	100mV	94%
SDR-480□-48	48V, 0~10A	±1.0%	120mV	94%

□ =blank, P ; Blank: basic function, P: with parallel function

960W



Model No.	Output	Tol.	R&N	Effi.
SDR-960-24	24V, 0~40A	±1.0%	180mV	94%
SDR-960-48	48V, 0~20A	±1.0%	250mV	94%



Features

- Universal AC input / Full range
- Built-in active PFC function(NDR-240/480)
- High efficiency up to 92.5%
- Protections: Short circuit / Overload / Over voltage / Over temperature
- Cooling by free air convection
- DC output voltage adjustable
- Can be installed on DIN rail TS-35 / 7.5 or 15
- UL508 (industrial control equipment) listed
- EN61000-6-2 (EN50082-2) industrial immunity level
- 3 years warranty

General Specification (Please refer to www.meanwell.com for detail spec.)



Model No.	NDR-75	NDR-120	NDR-240	NDR-480
AC input voltage range	90~264VAC; 127~370VDC			
AC inrush current (max.)	Cold start, 35A at 230VAC			
DC adjustment range	12V: 12~14V, 24V: 24~28V, 48V: 48~55V			
Overload protection	Range	105%~130%		
	Type	Constant current limiting, auto-recovery		Constant current limiting, shut off after 3 sec., re-power on to recover
Over voltage protection	Range	12V: 14~17V, 24V: 29~33V, 48V: 56~65V		
	Type	Shut down o/p voltage, re-power on to recover		
Over temperature protection	Shut down o/p voltage, re-power on to recover		Shut down o/p voltage, auto-recovery	
Withstand voltage	I/P-O/P: 3kVAC, I/P-FG: 2kVAC, O/P-FG: 0.5kVAC			
Working temperature	-20~+70°C (refer to output derating curve)			
Safety standards	UL508, TUV BS EN/EN62368-1, EAC TP TC 004, BSMI CNS14336-1(NDR-240/480) approved			
EMC standards	BS EN/EN55032 class B, EN61000-3-2,3, EN61000-4-2,3,4,5,6,8,11, EN61000-6-2(EN50082-2), EN61204-3; EAC TP TC 020			
Connection (screw DIN terminal)	I/P: 3 poles, O/P: 4 poles			
Dimension (WxHxD)(mm)	32x 125.2x 102	40x 125.2x 113.5	63x 125.2x 113.5	85.5x 125.2x 128.5

75W		NDR-75		
Model No.	Output	Tol.	R&N	Effi.
NDR-75-12	12V, 0~6.3A	±2.0%	80mV	85.5%
NDR-75-24	24V, 0~3.2A	±1.0%	150mV	88.0%
NDR-75-48	48V, 0~1.6A	±1.0%	240mV	89.0%

240W		NDR-240		
Model No.	Output	Tol.	R&N	Effi.
NDR-240-24	24V, 0~10A	±1.0%	150mV	88.5%
NDR-240-48	48V, 0~5A	±1.0%	150mV	90.0%

120W		NDR-120		
Model No.	Output	Tol.	R&N	Effi.
NDR-120-12	12V, 0~10A	±2.0%	100mV	85.5%
NDR-120-24	24V, 0~5A	±1.0%	120mV	88.0%
NDR-120-48	48V, 0~2.5A	±1.0%	150mV	89.0%

480W		NDR-480		
Model No.	Output	Tol.	R&N	Effi.
NDR-480-24	24V, 0~20A	±1.0%	150mV	92.5%
NDR-480-48	48V, 0~10A	±1.0%	150mV	92.5%



Features

- Universal AC input / Full range
- Protections: Short circuit / Overload / Over voltage / Over temperature
- Cooling by free air convection
- DC output voltage adjustable
- Can be installed on DIN rail TS-35 / 7.5 or 15
- UL508 (industrial control equipment) listed
- EN61000-6-2 (EN50082-2) industrial immunity level
- Low cost
- 2 years warranty

General Specification (Please refer to www.meanwell.com for detail spec.)



Model No.	EDR-75	EDR-120	EDR-150
AC input voltage range	90~264VAC; 127~370VDC		
AC inrush current (max.)	Cold start, 35A at 230VAC		
DC adjustment range	12V: 12~14V, 24V: 24~28V, 48V: 48~55V		
Overload protection	Range	105%~130%	
	Type	Constant current limiting, auto-recovery	
Over voltage protection	Range	12V: 14~17V, 24V: 29~33V, 48V: 56~65V	24V: 29~33V
	Type	Shut down o/p voltage, re-power on to recover	
Over temperature protection	Shut down o/p voltage, re-power on to recover		
Withstand voltage	I/P-O/P: 3kVAC, I/P-FG: 2kVAC, O/P-FG: 0.5kVAC		
Working temperature	-20~+60°C (refer to output derating curve)		
Safety standards	UL508, TUV BS EN/EN62368-1, EAC TP TC 004, BSMI CNS14336-1 approved		
EMC standards	BS EN/EN55032 classA, EN61000-3-2(125W for EDR-150),3, BS EN/EN61000-4-2,3,4,5,6,8,11, EN61000-6-2(EN50082-2); EAC TP TC 020, CNS13438		
Connection (screw DIN terminal)	I/P: 3 poles, O/P: 4 poles		
Dimension (WxHxD)(mm)	32x 125.2x 102	40x 125.2x 113.5	

75W EDR-75

Model No.	Output	ToI.	R&N	Effi.
EDR-75-12	12V, 0~6.3A	±2.0%	80mV	85.5%
EDR-75-24	24V, 0~3.2A	±1.0%	120mV	87.5%
EDR-75-48	48V, 0~1.6A	±1.0%	150mV	88.5%

150W EDR-150

Model No.	Output (230VAC/115VAC)	ToI.	R&N	Effi.
EDR-150-24	24V, 0~6.5A / 0~5.2A	±1.0%	150mV	87%

120W EDR-120

Model No.	Output	ToI.	R&N	Effi.
EDR-120-12	12V, 0~10A	±2.0%	100mV	85.0%
EDR-120-24	24V, 0~5A	±1.0%	120mV	87.5%
EDR-120-48	48V, 0~2.5A	±1.0%	150mV	88.5%

EDR vs. NDR

Difference Series	EMI	Working Temp.	Warranty
EDR	Class A	-20~+60°C	2 years
NDR	Class B	-20~+70°C	3 years



Features

- Single or two phase ultra wide input range 180~550VAC
- Built-in active PFC function (WDR-240/480)
- Protections: Short circuit / Overload / Over voltage / Over temperature
- Cooling by free air convection
- DC output voltage adjustable
- Built-in constant current limiting circuit
- Can be installed on DIN rail TS-35 / 7.5 or 15
- Over voltage category III (WDR-60)
- EN61000-6-2(EN50082-2) industrial immunity level
- Built-in DC OK relay contact
- 3 years warranty

General Specification (Please refer to www.meanwell.com for detail spec.)

Model No.	WDR-60	WDR-120	WDR-240	WDR-480
AC input voltage range	180~550VAC(single or two phase); 254~780VDC			
AC input current	0.3A / 400VAC, 0.6A / 230VAC	0.55A / 400VAC, 1.2A / 230VAC	1A / 400VAC, 2A / 230VAC	1.6A / 400VAC, 4A / 230VAC
AC inrush current (max.)	Cold start, 50A at 400VAC			
DC adjustment range	5V: 5~6V, 12V: 12~15V, 24V: 24~29V, 48V: 48~57V	12V: 12~15V, 24V: 24~29V, 48V: 48~58V	24V: 24~28V, 48V: 48~55V	
Overload protection	Hiccup mode when output voltage <50%, constant current limiting within 50~100% rated output voltage, auto-recovery	105%~130% rated output power, constant current limiting, auto-recovery	105%~130% rated output power, constant current limiting, unit will shut down after 3 sec.; auto-recovery after 1 minute if the fault condition is removed.	
Over voltage protection	Range	5.7~7.5V for 5V model (WDR-60), 16~18V for 12V model, 29~33V for 24V model, 56~65V for 48V model		
	Type	Shut down o/p voltage, re-power on to recover		
Over temp. protection	Shut down output voltage, recovers automatically after temperature goes down			
Withstand voltage	I/P-O/P:4.7kVAC, I/P-FG:2.5kVAC, O/P-FG:0.5kVAC, O/P-DC OK:0.5kVAC, 1 minute	I/P-O/P:3kVAC, I/P-FG:1.5kVAC, O/P-FG:0.5kVAC, O/P-DC OK:0.5kVAC, 1 minute		
Isolation resistance	100MΩ(min.)@500VDC			
Working temperature	-30~+85°C	-25~+70°C	-30~+70°C (refer to output derating curve)	
DC OK signal	Relay Contact			
Safety standards	UL61010, TUV BS EN/EN61558-2-16, AS/NZS62368.1, EAC TP TC004	UL508, AS/NZS62368.1, EAC TP TC 004 , BS EN/EN62368-1 approved; Design refer to GL		
EMC standards	BS EN/EN55032 class B, EN61000-3-2,3, EN61000-4-2,3,4,5,6,8,11, EN61000-6-2 (EN50082-2), EN61204-3; EAC TP TC 020, heavy industry level			
Connection (screw DIN terminal)	I/P: 3 poles, O/P: 4 poles		I/P: 3 poles, O/P: 6 poles	
Dimension (WxHxD)(mm)	32x125.2x102	40x125.2x113.5	63x125.2x113.5	85.5x125.2x128.5

60W



Model No.	Output	Tol.	R&N	Effi.
WDR-60-05	5V, 0~10A	±1.5%	100mV	83.5%
WDR-60-12	12V, 0~5A	±1.5%	120mV	86.5%
WDR-60-24	24V, 0~2.5A	±1.0%	150mV	89.0%
WDR-60-48	48V, 0~1.25A	±1.0%	200mV	90.5%

240W



Model No.	Output	Tol.	R&N	Effi.
WDR-240-24	24V, 0~10A	±1.0%	150mV	91%
WDR-240-48	48V, 0~5A	±1.0%	150mV	91%

120W



Model No.	Output	Tol.	R&N	Effi.
WDR-120-12	12V, 0~10A	±1.5%	120mV	89.5%
WDR-120-24	24V, 0~5A	±1.0%	120mV	91%
WDR-120-48	48V, 0~2.5A	±1.0%	150mV	92%

480W



Model No.	Output	Tol.	R&N	Effi.
WDR-480-24	24V, 0~20A	±1.0%	100mV	92%
WDR-480-48	48V, 0~10A	±1.0%	150mV	93%



Features

- 3-phase, 340~550VAC wide range input (2-phase operation possible)
- Slim width
- Built-in active PFC function (TDR-480/960)
- Built-in passive PFC function (TDR-240)
- High efficiency up to 94.5%
- Protections: Short circuit / Overload / Over voltage / Over temperature
- Cooling by free air convection
- DC output voltage adjustable
- Built-in constant current limiting circuit
- Can be installed on DIN rail TS-35/7.5 or 15
- UL508 / UL61010-1 Industrial control equipment approved
- Current sharing up to 3840W(3+1) for TDR-960
- Built-in DC OK relay contact (optional for TDR-480)
- 3 years warranty

General Specification (Please refer to www.meanwell.com for detail spec.)

Model No.	TDR-240	TDR-480	TDR-960
AC input voltage range	3-phase 340~550VAC (2-phase operation possible), 480~780VDC		
AC input current (Typ.)	0.69A / 400VAC, 0.6A / 500VAC	0.85A / 400VAC, 0.7A / 500VAC	2.0A / 400VAC, 1.4A / 500VAC
DC adjustment range	24V: 24~28V, 48V: 48~55V		
Overload protection	105%~130% rated output power, constant current limiting, unit will shut down after 3 sec., re-power on to recover 105%~130% rated output power, constant current limiting, unit will hiccup after 3 sec.(TDR-240)		
Over voltage protection	Range	29~33V for 24V model, 56~65V for 48V model (30~36V for TDR-240-24)	
	Type	Shut down o/p voltage, re-power on to recover Hiccup mode, recovers automatically after temperature goes down.	
Over temperature protection	Shut down o/p voltage, auto-recovery after temperature goes down		
Withstand voltage	I/P-O/P:4.87kVAC I/P-FG:2.4kVAC O/P-FG:0.5kVAC O/P-DC OK: 0.5kVAC	I/P-O/P:3kVAC I/P-FG:2kVAC O/P-FG:0.5kVAC O/P-DC OK: 0.5kVAC(TDR-960; optional for TDR-480)	
Working temperature	-30~+70°C (refer to output derating curve)		
Safety standards	UL61010-1, UL61010-2-201, AS/NZS62368.1, EAC TP TC 004, BS EN/EN61558-2-16 approved	UL508, IEC62368-1, AS/NZS62368.1, EAC TP TC 004 approved; UL62368-1 for TDR-480	
EMC standards	BS EN/EN55032 class B, EN61000-3-2,3, EN61000-4-2,3,4,5,6,8,11, EN61204-3, EN55024,EN61000-6-2, heavy industry level; EAC TP TC 020		
Connection (screw DIN terminal)	I/P: 4 poles, O/P: 4 poles		I/P: 4 poles, O/P: 6 poles
Dimension (WxHxD)(mm)	63x 125.2x 113.5	85.5x 125.2x 128.5	110x125.2x150

240W

Model No.	Output	Tol.	R&N	Effi.
TDR-240-24	24V, 0~10A	±1.0%	100mV	92%
TDR-240-48	48V, 0~5A	±1.0%	120mV	92%

960W

Model No.	Output	Tol.	R&N	Effi.
TDR-960-24	24V, 0~40A	±1.0%	180mV	94.0%
TDR-960-48	48V, 0~20A	±1.0%	250mV	94.5%

480W

Model No.	Output	Tol.	R&N	Effi.
TDR-480-24	24V, 0~20A	±1.0%	150mV	92.5%
TDR-480-48	48V, 0~10A	±1.0%	150mV	93%

WDR vs. TDR

Series	Difference	AC Input Voltage
WDR		1φ ; 180~550VAC
TDR		3φ ; 340~550VAC



DRA-40



DRA-60

Features

- Universal AC input / Full range
- **Io can be trimmed 10~100% by 1~10Vdc, PWM signal or resistance**
- Installed on DIN rail TS-35 / 7.5 or 15
- Protections: Short circuit / Overload / Over voltage
- Pass LPS
- Cooling by free air convection
- DC output voltage adjustable
- LED indicator for power on
- Suitable for machine vision inspection system and plant cultivation application
- 3 years warranty

General Specification (Please refer to www.meanwell.com for detail spec.)



Model No.	DRA-40	DRA-60
AC input voltage range	90~264VAC; 127~370VDC	
AC inrush current (max.)	Cold start, 60A at 230VAC	
DC adjustment range	12V: 12~15V, 24V: 24~30V	
Current adjustment range	10%~100% rated output current adjustable by 1~10VDCc, PWM signal or resistance	
Overload protection	Range	95%~108%
	Type	Constant current limiting, auto-recovery
Over voltage protection	120%~155% rated output power, shut down o/p voltage, re-power on to recover	
Withstand voltage	I/P-O/P: 3kVAC, I/P-FG: 2kVAC, O/P-FG: 0.5kVAC	
Working temperature	-30~+70°C (refer to output derating curve)	
Safety standards	UL62368-1, TUV BS EN/EN62368-1, EAC TP TC 004 approved	
EMC standards	BS EN/EN55032 class B, EN61000-3-2,3, EN61000-4-2,3,4,5,6,8,11, EN61204-3; EAC TP TC 020	
Connection (screw DIN terminal)	I/P: 3 poles, O/P: 6 poles screw DIN terminal	
Dimension (WxHxD)(mm)	40x 90x 100	

40W DRA-40

Model No.	Output	Tol.	R&N	Effi.
DRA-40-12	12V, 0~3.34A	±1.0%	120mV	85%
DRA-40-24	24V, 0~1.7A	±1.0%	150mV	87%

60W DRA-60

Model No.	Output	Tol.	R&N	Effi.
DRA-60-12	12V, 0~5A	±1.0%	120mV	85%
DRA-60-24	24V, 0~2.5A	±1.0%	150mV	87%



■ Features

- Output current 20A & 40A
- Support **1+1** and **N+1** redundancy system
- Suitable for redundancy operation of 12V/24V/48V system
- 2 channels input and 1 output
- **-40~+80°C** ultra wide operation temp.
- **2 dry relay contact** for monitoring output status, and LED indicator for input failure alarm
- **Slim width**
- Installed on DIN rail TS-35/7.5 or 15
- 3 years warranty

ERDN20/40 series, enclosed type modules are available on P.28

■ General Specification (Please refer to www.meanwell.com for detail spec.)



Model No.	DRDN20 ^[24]			DRDN40 ^[24]				
	12	24	48	12	24	48		
Input	DC input voltage range	9~14Vdc	19~29Vdc	36~60Vdc	9~14Vdc	19~29Vdc	36~60Vdc	
	Rated current	10Ax2 input, 20Ax1 input			20Ax2 input, 40Ax1 input			
	Peak current	15Ax2 input, 30Ax1 input			30Ax2 input, 60Ax1 input			
	Voltage drop (Vin-Vout)	0.2~0.5Vdc max.						
	Reverse voltage (max.)	40Vdc	40Vdc	65Vdc	40Vdc	40Vdc	65Vdc	
Output	Rated current	20A			40A			
	Peak current	30A, 5 sec.			60A, 5 sec.			
	Standby power losses	1.5W Typ.						
General	Relay contact	2 dry relay contact, 30Vdc resistive load for each channel						
	Input voltage alarm	Voltage range	<8.5V or >14.7V	<18V or >31V	<34.2V or >63V	<8.5V or >14.7V	<18V or >31V	<34.2V or >63V
		LED display	Green: OK, dark: input voltage failure					
	Working temperature	-40~+80°C						
	Protections	Overload or short circuit, <30A for 5 sec. no damage						
	Cooling	Free air convection						
	Safety standards	UL62368-1, EAC TP TC 004 approved						
	EMC standards	BS EN/EN55032 class B, EN61000-4,2,3,4,5,6,8						
	Connection (Screw DIN terminal)	I/P: 4 poles(V _{in1} and V _{in2} ±), O/P and FG 4 poles (V _{O-} /V _O , FG); 4 poles (Alarm ₁ and Alarm ₂ dry relay contact)			I/P: 4 poles(V _{in1} and V _{in2} ±), O/P 2 poles (V _{O-} /V _O), FG 1 pole; 2+2 poles (Alarm ₁ and Alarm ₂ dry relay contact)			
	Dimension (WxHxD)(mm)	32x 125.2x 102			55x 125.2x 113.5			

■ 20A DRDN20

Model No.	Nominal Voltage	Input / Output Current
DRDN20 ^[24]	12V, 24V, 48V	2x10A / 20A
□ = 12, 24, 48		

■ 40A DRDN40

Model No.	Nominal Voltage	Input / Output Current
DRDN40 ^[24]	12V, 24V, 48V	2x20A / 40A
□ = 12, 24, 48		

DRDN20/40 Example of Application

1+N Redundancy : Using 1 more PSU as the redundant unit

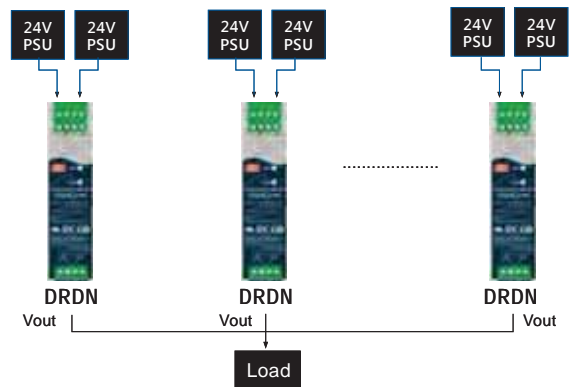

Note: 12V/ 24V/ 48V models are applicable.



■ Features

- Buffering with **electrolytic capacitors** instead of battery, save maintenance cost
- Suitable for 24Vdc systems
- Buffering time: **350ms@20A load**; **250ms@40A load**
- Buffer mode selectable by switch :
Fixed mode at 22Vdc or dynamic mode for Vin-1V
- **Support parallel connection** to extend buffering time
- -25~+75°C operating temperature
- 3 years warranty

■ General Specification (Please refer to www.meanwell.com for detail spec.)



Model No.		DBUF20	DBUF40	
Charging mode	DC normal operating mode	24Vdc		
	Charging voltage	23~30Vdc		
	Charging current	900mA Max.		
	Current consumption at standby	100mA Max.		
	Charging time	15s Typ. 25s Max.	25s Typ. 35s Max.	
Buffer mode	DC normal operating voltage	22Vdc / Vin-1Vdc		
	DC operating voltage range	22-29Vdc		
	Output current (max.)	20A	40A	
	Ripple & Noise (max.)	200mVp-p		
Protection		Over voltage / Overload / Short circuit / Reverse polarity		
Function	Selectable by switch	Fix 22Vdc(Default)	Buffering starts if terminal voltage falls below 22Vdc	
		Vin-1Vdc	Buffering starts if terminal voltage is decreased by >1Vdc	
	Control	Inhibit(I)	+>:Vs-V(I)<6Vdc: Buffer module ONVs-V(I)>10Vdc: Buffer module OFF 35Vdc/4mA Max.	
		Ready(R)	Charged ready: V(R)>+Vs - 2Vdc; Unready: V(R)<1Vdc 35Vdc/10mA Max.	
			Buffering(B)	Buffering: V(B)>+Vs - 2Vdc; Other mode: V(B)<1Vdc 35Vdc /10mA Max.
Supply Voltage(+Vs)	10~35Vdc/10mA(Connected to +V or external voltage)			
Working temperature		-25~+75°C (refer to output derating curve)		
Safety standards		IEC62368-1,UL62368-1 approved		
EMC standards		BS EN/EN55032 class B, EN61000-4-2,3,4,5,6,8		
Connection (screw DIN terminal)		Parallel: 4 poles(+Vx2, -Vx2), Function: I(Inhibit), R(Ready), B(Buffering), FG		
Dimension (WxHxD)(mm)		63x 125.2x 114.9		

20A DBUF20			40A DBUF40		
Model No.	DC Operating Voltage Range	Buffer Time	Model No.	DC Operating Voltage Range	Buffer Time
DBUF20-24	22~29Vdc	350ms@20A	DBUF40-24	22~29Vdc	250ms@40A
		700ms@10A			500ms@20A
		45s@0.1A			42s@0.1A

NEW



DUPS-20



DUPS-40

Features

- Uninterruptible DC-UPS controller
- **Parallel connected to DC BUS (Power supply + DC-UPS Module + Batteries + Load)**
- Allows 4AH~135AH lead-acid various battery capacities
- Complete diagnostic and monitoring for DC BUS OK, battery discharge, battery fail
- LED indicator for signal status
- Protections: Battery reverse polarity protection & Short circuit(By internal fuse) /Battery discharge / Over discharge current
- Cooling by free air convection
- Suitable for 24V system
- 3 years warranty

General Specification (Please refer to www.meanwell.com for detail spec.)



Model No.		DUPS20	DUPS40
DC BUS	Discharger Current	0~20A	0~40A
	BAT Voltage	21~29Vdc	
	PSU Voltage	24~29Vdc	
	Charging Current(typ.)	2A	
Battery	Normal BAT Voltage	24Vdc(2x12Vdc in series or 1x24Vdc)	
	BAT Type	Lead-acid battery	
	External battery(typ.)	24Vdc, 4AH~135AH	
Protections	BAT Polarity	By internal fuse	
	Short Circuit	This protection only works when batteries are not connected. External fuse is recommended and when batteries are connected	
	Over discharge current	21~26A	42~52A
	BAT deep discharge	Cut-off battery discharge by RELAY	
Functions	DC BUS OK	RELAY status	Short when DC voltage between 21~29Vdc(±2%), RELAY contact
		LED(Green)	DC BUS OK: Light, DC BUS fail: Dark
	BAT fail	RELAY status	Short when battery voltage falls below 22Vdc(±2%)or battery failure is observed through the battery test function,RELAY contact
		LED(Red)	Battery over-discharge warning or battery broken:Light Battery OK:Dark
	BAT discharge	RELAY status	Short when battery in discharge condition,RELAY contact
		LED(Yellow)	Battery discharge:Light Battery is not discharge:Dark
Working temperature		-30~+70°C (refer to output derating curve)	
Safety standards		EAC TP TC 004 approved	
EMC standards		BS EN/EN55032 class B, EN61000-3-2,3, EN61000-4-2,3,4,5,6,8,11, EN61204-3, EAC TP TC 020	
Connection (screw DIN terminal)		I/P: 2 poles, O/P: 2 poles screw DIN terminal,Single Output: 6 poles	
Dimension (WxHxD)(mm)		40x 125.2x 113.5	63x 125.2x 113.5

20A/40A

DUPS20/40

Model No.	DC BUS Voltage	DC BUS Current
DUPS20	24~29Vdc	20A
DUPS40	24~29Vdc	40A



Features

- Battery controller for DIN rail UPS system
- Parallel connected to DC BUS
- Suitable for 24V system up to 40A
- Installed on DIN Rail TS-35 / 7.5 or 15
- Built-in battery test function
- Battery polarity protection
- Relay contact signal output and LED indicator for DC BUS OK, Battery Fail, and Battery Discharge
- Cooling by free air convection
- 3 years warranty

It is highly recommended to use DUPS40 for all new project



Model No.	DR-UPS40		
DC BUS	Discharge Current	0~40A	
	BAT voltage	21~29Vdc	
	PSU Voltage	24~29Vdc	
	Charging current (typ.)	2A	
Battery	External battery (typ.)	24Vdc, 4AH / 7AH / 12AH	
Functions	DC BUS OK	Relay status	Short when DC voltage between 21~29V(±3%), relay contacts
		LED(Green)	DC bus OK : Light; DC bus fail : Dark
	BAT fail	Relay status	Short when battery failure is observed through the battery test function, relay contacts
		LED(Red)	Battery over-discharge warning or battery broken: Light; Battery OK: Dark
	BAT discharge	Relay status	Short when battery in discharge condition, relay contacts
		LED(Yellow)	Battery discharging: light; Battery is not discharging or discharging current <2A: Dark
Working temperature	-20~+70°C		
EMC standards	BS EN/EN55032 class B, EN61000-4-2,3,4,5,6,8,11; EAC TP TC 020		
Connection	I/P: 2 poles, O/P: 2 poles screw DIN terminal, Single output: 6 poles		
Dimension (WxHxD)(mm)	55.5 x 125.5 x 100		

40A DR-UPS40

Model No.	DC BUS Voltage	DC BUS Current
DR-UPS40	24~29V	40A max.

DR-UPS40&DUPS20/40 Example of Application



DBUF20/40 Example of Application

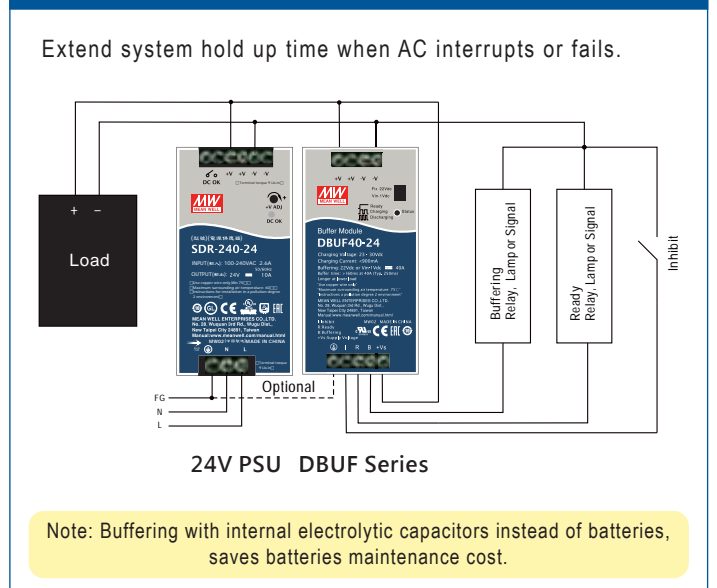



Features

- **DIN Rail type** or **terminal block** mounted
- ICL-16: 23A inrush current limiting, 16A continuous
ICL-28: 48A inrush current limiting, 28A continuous
- 180~264VAC input
- Integrated by pass relay, no simple NTC
- Internal thermal protection
- -30~+70°C wide operating temperature
- **Over voltage category III**
- Operating altitude up to **5000 meters**
- Installed on DIN Rail TS-35/7.5 or 15 (ICL-16R/28R)

General Specification (Please refer to www.meanwell.com for detail spec.)



Model No.	ICL-16R	ICL-16L	ICL-28R	ICL-28L
AC input voltage range	180~264VAC, 50/60Hz			
AC inrush current limiting	23A max., 16A continuous		48A max. 28A continuous	
AC input power	3680VA (16Ax 230VAC)		6440VA (28Ax 230VAC)	
AC input consumption	<1.5W at 264VAC input		<2W at 264VAC input	
Internal relay limiting time (Ton power on)	300±50ms			
Internal relay	Limiting cycle	PSU setup time <250ms 1 cycle / 5min	PSU setup time 250~350ms 1 cycle / 1min	PSU setup time >350ms 5 cycle / 1min
	Release time	500±50ms		
Internal protection	Thermal fuse protects overload and fire			
Load capacity	2500µF max.		6000µF max.	
Working temperature	-30~+70°C			
Safety standards	IEC62368-1 (LVD)			
EMC standards	BS EN/EN55032 class B, EN61000-3-2, EN61000-4-2,3,4,5,6,8,11, EAC TP TC020			
Connection	ICL-16R/28R: I/P: 2 poles, O/P: 2 poles (Screw DIN terminal); ICL-16L/28L: I/P: 2 poles, O/P: 2 poles (Terminal block)			
Dimension (mm)	35x 90x 54.5 (WxHxD)	175x 42x 24 (LxWxH)	52.5x 90x 54.5 (WxHxD)	175x 42x 24 (LxWxH)

16A ICL-16R/L

Model No.	Inrush Current	Type.
ICL-16R	16A	DIN Rail
ICL-16L	16A	Terminal Block

28A ICL-28R/L

Model No.	Inrush Current	Type.
ICL-28R	28A	DIN Rail
ICL-28L	28A	Terminal Block

Example of Application

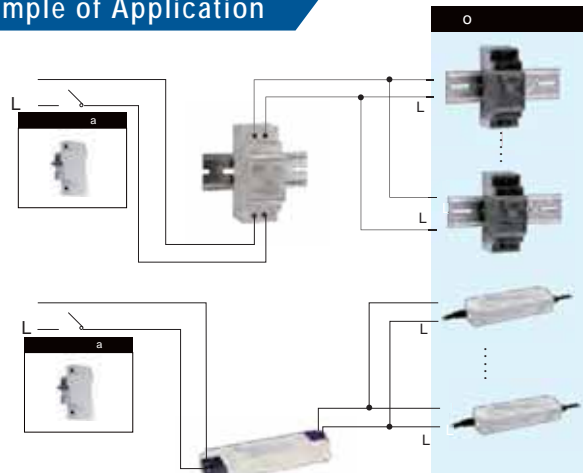

For the number of power supplies being able to be connected to ICL-16R/L and ICL-28R/L, please refer to the installation manual.

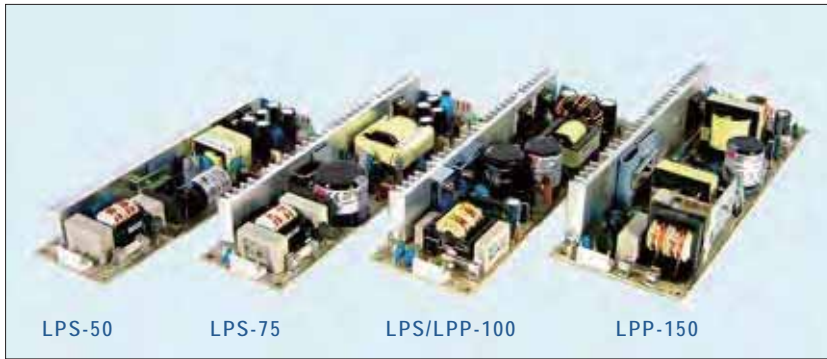

Features

- Universal AC input / Full range
- Built-in active PFC function (LPP-100/150)
- Protections: Short circuit / Overload / Over voltage
- Optional over temperature protection for LPP-150
- Built-in remote ON/OFF control (LPS-50/75)
- Cooling by free air convection
- 2 years warranty for LPS series
- 3 years warranty for LPP series

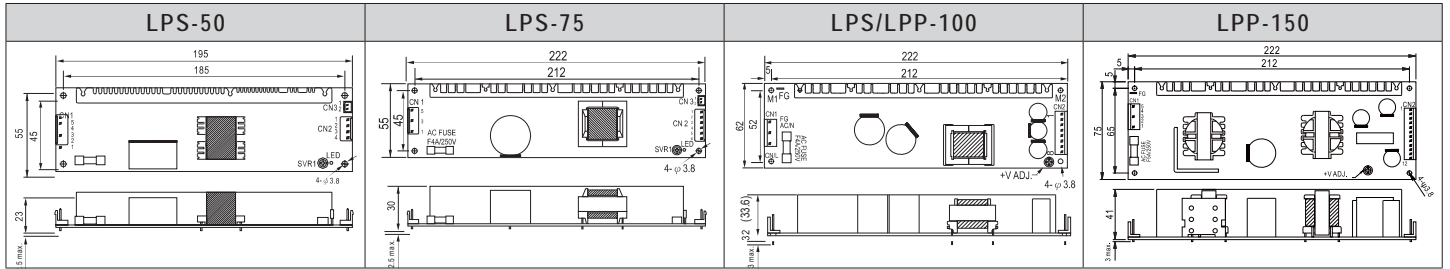

General Specification (Please refer to www.meanwell.com for detail spec.)



Model No.	LPS-50	LPS-75	LPS-100	LPP-100	LPP-150
AC input voltage range	90~264VAC		115/230 auto switch	85~264VAC	
AC inrush current (230VAC)	35A	36A	60A	30A	55A
DC adjustment range	±10% rated output voltage			-5%~+10% rated output voltage	
Overload protection	Range	122%~160%	115%~150%	105%~140%	105%~150% rated output power
	Type	Hiccup mode, auto recovery			Constant current limiting, auto recovery
Over voltage protection	Range	110%~135% of rated output voltage			Shut off, AC recycle to re-start
	Type	Hiccup mode, auto recovery			
Withstand voltage	I/P-O/P: 3kVAC, I/P-FG: 1.5kVAC(2kVAC for LPP-150), O/P-FG: 0.5kVAC, 1 minute				
Working temperature	-20~+70°C (refer to output derating curve)		-10~+60°C (refer to output derating curve)		
Safety standards	UL62368-1, TUV BS EN/EN62368-1, EAC TP TC 004 approved				
EMC standards	BS EN/EN55032 class B, EN61000-3-2,3, EN61000-4-2,3,4,5,6,8,11 (EN61000-6-2 heavy industry level for LPS-50/75 only); EAC TP TC 020				
Connection	JST B5P / B4P-VH	JST B5P / B6P-VH	JST B5P / B8P-VH	JST B5P / B6P2-VH	
Dimension (LxWxH)(mm)	195x 55x 23	222x 55x 30	222x 62x 32	222x 62x 33.6	222x 75x 41

50W LPS-50

Model No.	Output	Tol.	R&N	Effi.
LPS-50-3.3	3.3V, 0~10A	±3%	50mV	75%
LPS-50-5	5V, 0~10A	±3%	50mV	81%
LPS-50-12	12V, 0~4.2A	±2%	80mV	82%
LPS-50-15	15V, 0~3.4A	±2%	80mV	84%
LPS-50-24	24V, 0~2.1A	±1%	80mV	85%
LPS-50-48	48V, 0~1.1A	±1%	100mV	86%

75W LPS-75

Model No.	Output	Tol.	R&N	Effi.
LPS-75-3.3	3.3V, 0~15A	±3%	80mV	69%
LPS-75-5	5V, 0~15A	±3%	80mV	77%
LPS-75-12	12V, 0~6.2A	±2%	100mV	80%
LPS-75-15	15V, 0~5.0A	±2%	100mV	81%
LPS-75-24	24V, 0~3.2A	±2%	120mV	83%
LPS-75-48	48V, 0~1.56A	±2%	120mV	83%

100W LPS-100

Model No.	Output	Tol.	R&N	Effi.
LPS-100-3.3	3.3V, 0~20A	±3%	150mV	69%
LPS-100-5	5V, 0~20A	±3%	100mV	77%
LPS-100-7.5	7.5V, 0~13.3A	±2%	100mV	77%
LPS-100-12	12V, 0~8.4A	±2%	100mV	79%
LPS-100-13.5	13.5V, 0~7.5A	±2%	100mV	79%
LPS-100-15	15V, 0~6.7A	±2%	100mV	80%

LPS-100-24	24V, 0~4.2A	±1%	150mV	80%
LPS-100-27	27V, 0~3.8A	±1%	150mV	81%
LPS-100-48	48V, 0~2.1A	±1%	200mV	81%

100W (with PFC Function) LPP-100

Model No.	Output	Tol.	R&N	Effi.
LPP-100-3.3	3.3V, 0~20A	±2%	100mV	69%
LPP-100-5	5V, 0~20A	±2%	100mV	75%
LPP-100-7.5	7.5V, 0~13.5A	±2%	100mV	76%
LPP-100-12	12V, 0~8.5A	±2%	100mV	79%
LPP-100-13.5	13.5V, 0~7.5A	±2%	100mV	79%
LPP-100-15	15V, 0~6.7A	±2%	100mV	80%
LPP-100-24	24V, 0~4.2A	±1%	150mV	83%
LPP-100-27	27V, 0~3.8A	±1%	150mV	83%
LPP-100-48	48V, 0~2.1A	±1%	250mV	83%

150W (with PFC Function) LPP-150

Model No.	Output	Tol.	R&N	Effi.
LPP-150-3.3	3.3V, 0~30A	±2%	100mV	70%
LPP-150-5	5V, 0~30A	±2%	100mV	76%
LPP-150-7.5	7.5V, 0~20A	±2%	100mV	80%
LPP-150-12	12V, 0~12.5A	±2%	100mV	82%
LPP-150-13.5	13.5V, 0~11.2A	±2%	100mV	83%
LPP-150-15	15V, 0~10A	±2%	100mV	83%
LPP-150-24	24V, 0~6.3A	±1%	150mV	85%
LPP-150-27	27V, 0~5.6A	±1%	150mV	85%
LPP-150-48	48V, 0~3.2A	±1%	250mV	85%



Features

- Universal AC input / Full range
- Cooling by free air convection
- Protections: Short circuit / Overload / Over temp. / Over voltage(PS-05/PD-25 only)
- 2 years warranty

General Specification (Please refer to www.meanwell.com for detail spec.)



Model No.	PS-05	PD-25	PD/PT-45	PD/PT-65	PT-6503
AC input voltage range	85~264VAC; 120~370VDC		90~264VAC; 120~370VDC		
Leakage current (at 240VAC)	Less than 0.5mA		Less than 0.75mA		Less than 1.0mA
AC inrush current (max.)	Cold start, 30A at 230VAC	Cold start, 36A at 230VAC	Cold start, 30A at 230VAC	Cold start, 40A at 230VAC	
Overload protection	>105% hiccup mode, auto-recovery		53~75W hiccup mode, auto-recovery	73~105W hiccup mode, auto-recovery	120%~160% hiccup mode, auto-recovery
Over voltage protection	115%~150%	115%~135%	CH1: 115%~135% rated output voltage		
Withstand voltage	I/P-O/P: 3kVAC, I/P-FG:1.5kVAC	I/P-O/P: 3kVAC, I/P-FG:2kVAC	I/P-O/P: 3kVAC, I/P-FG:1.5kVAC		
Safety standards	EAC TP TC 004, UL62368-1, TUV BS EN/EN62368-1, EAC TP TC 004 approved				
EMC standards	BS EN/EN55032 class B, EN61000-3-2,3, EAC TP TC 020 EN61000-4-2,3,4,5,6,8,11	BS EN/EN55032 class B, EN61000-3-2,3, EAC TP TC 020 EN61000-4-2,3,4,5	BS EN/EN55032 class B, EN61000-3-2,3, EAC TP TC 020, EN61000-4-2,3,4,5,6,8,11		BS EN/EN55032 class B, EN61000-3-2, EAC TP TC 020, EN61000-4-2,3,4,6,11
Connection	3P/ 5mm, 2P/ 3.96mm pitch, Molex 5285-03,5273-02	3P, 4P/ 3.96mm pitch, Molex P/N: 41791-03, 04	2P, 6P/ 3.96mm pitch, Molex 5277-02 / 5273-06	2P, 6P/ 3.96mm pitch, Molex P/N: 5277-02, 5273-06	2P, 8P/ 3.96mm pitch, Molex: 5277-02, 5273-08

5W PS-05

Model No.	Output	Tol.	R&N	Effi.
PS-05-5	5V, 0~1.0A	±2%	100mV	70%
PS-05-12	12V, 0~0.45A	±2%	120mV	75%
PS-05-15	15V, 0~0.35A	±2%	120mV	75%
PS-05-24	24V, 0~0.22A	±2%	200mV	76%
PS-05-48	48V, 0~0.11A	±1%	200mV	76%

25W PD-25

Model No.	Output	Tol.	R&N	Effi.	Max.
PD-25A	5V, 0.2~2.5A	±2%	50mV	71%	25W
PD-25B	12V, 0.1~1.5A	±6%	150mV		
PD-2505	5V, 0.2~2.0A	±2%	50mV	77%	25W
PD-2505	24V, 0.1~1.0A	±6%	200mV		
PD-2512	5V, 0.1~3.0A	±6%	50mV	73%	25W
PD-2512	-5V, 0.1~2.5A	±6%	50mV		
PD-2512	12V, 0.1~1.2A	±4%	50mV	74%	24W
PD-2512	-12V, 0.1~1.2A	±4%	50mV		
PD-2515	15V, 0.1~1.0A	±4%	50mV	75%	24W
PD-2515	-15V, 0.1~1.0A	±4%	50mV		

45W PD-45

Model No.	Output	Tol.	R&N	Effi.	Max.
PD-45A	5V, 0.4~5.0A	±4%	50mV	77%	40W
PD-45B	12V, 0.2~2.5A	±7%	120mV		
PD-45B	5V, 0.4~5.0A	±4%	50mV	78%	45W
PD-45B	24V, 0.2~1.8A	±7%	120mV		

65W PD-65

Model No.	Output	Tol.	R&N	Effi.	Max.
PD-65A	5V, 0.4~7.0A	±4%	50mV	78%	61W
PD-65B	12V, 0.2~3.2A	±7%	120mV		
PD-65B	5V, 0.4~6.0A	±4%	50mV	81%	66W
PD-65B	24V, 0.2~2.6A	±7%	150mV		

45W PT-45

Model No.	Output	Tol.	R&N	Effi.	Max.
PT-45A	5V, 0.4~5.0A	±4%	50mV	75%	41W
PT-45B	12V, 0.2~2.5A	±7%	120mV		
PT-45B	-5V, 0.0~0.5A	±5%	50mV		
PT-45B	5V, 0.4~5.0A	±4%	50mV	75%	43W
PT-45B	12V, 0.2~2.5A	±7%	120mV		
PT-45B	-12V, 0.0~0.5A	±5%	100mV		
PT-45C	5V, 0.4~5.0A	±4%	50mV	75%	44W
PT-45C	15V, 0.2~2.3A	±7%	120mV		
PT-45C	-15V, 0.0~0.5A	±5%	100mV		

65W PT-65

Model No.	Output	Tol.	R&N	Effi.	Max.
PT-65A	5V, 0.4~7.0A	±4%	50mV	76%	60W
PT-65A	12V, 0.2~3.2A	±7%	120mV		
PT-65A	-5V, 0.0~0.7A	±5%	50mV		
PT-65B	5V, 0.4~7.0A	±4%	50mV	77%	64W
PT-65B	12V, 0.2~3.2A	±7%	120mV		
PT-65B	-12V, 0.0~0.7A	±5%	100mV		
PT-65C	5V, 0.4~7.0A	±4%	50mV	77%	65W
PT-65C	15V, 0.2~2.6A	±7%	120mV		
PT-65C	-15V, 0.0~0.7A	±5%	100mV		
PT-65D	5V, 0.5~5.0A	±4%	50mV	79%	68W
PT-65D	12V, 0.2~4.0A	±6%	100mV		
PT-65D	24V, 0.2~1.3A	±6%	200mV		

65W PT-6503

Model No.	Output	Tol.	R&N	Effi.	Max.
PT-6503	3.3V, 0.0~7.0A	±3%	50mV	72%	62W
PT-6503	5V, 0.2~10A	+4%, -2%	50mV		
PT-6503	12V, 0.0~1.2A	±8%	100mV		



RPD/T-65
127x 76x 29 mm



PPT-125
127x 76.2x 34.6 mm



PID-250
222x 95x 40 mm

Features

- Universal AC input / Full range
- Protections: Short circuit / Overload / Over voltage / Over Temp. (PID-250)
- 2 years warranty (RPD/T-65)
- 3 years warranty (RPT-125/PID-250)

General Specification (Please refer to www.meanwell.com for detail spec.)



Model No.	RPD/T-65	PPT-125	PID-250
AC input voltage range	90~264VAC; 127~370VDC	90~264VAC; 127~370VDC	
Leakage current	Less than 1mA at 240VAC	Less than 2.0mA at 240VAC	Less than 3.5mA at 240VAC
AC inrush current (max.)	Cold start, 25A at 115VAC, 50A at 230VAC	Cold start, 40A at 230VAC	Cold start, 58A at 230VAC
Overload protection	90~125W hiccup mode, auto-recovery	130%~160% fold back current limiting, auto-recovery	
Over voltage protection	CH1: 115%~135% rated output voltage	CH1: 110%~135% rated output voltage	CH1: 115%~140%, CH2: 110%~135%
Withstand voltage	I/P-O/P: 3kVAC, I/P-FG: 2kVAC, 1minute		I/P-O/P: 3.0kVAC, I/P-FG: 2kVAC, 1minute
Safety standards	UL62368-1, TUV BS EN/EN62368-1, EAC TP TC 004 approved		
EMC standards	BS EN/EN55032 class B, EN61000-3-2,3, EN61000-4-2,3,4,5,6,8,11, EAC TP TC 020	BS EN/EN55032 class B, EN61000-3-2,3, EN61000-4-2,3,4,5,6,8,11, EAC TP TC 020	BS EN/EN55032 class B, EN61000-3-2,-3 EN61000-4-2,3,4,5,6,8,11, EN61000-6-2, EAC TP TC 020
Connection	3P, 6P/ 3.96mm pitch, Molex P/N: 5273-03, 5273-06	3+5Px2 /3.96mm pitch, JST: B3P/B5Px2-VH	5+10+2P/3.96mm pitch, JST B5P/B10P-VH, B2B-XH

65W RPD-65

Model No.	Output	Tol.	R&N	Effi.	Max.
RPD-65C	12V, 0~5.8A	±2%	120mV	79%	60W
	5V, 0~1.5A	±5%	50mV		
RPD-65D	24V, 0~2.9A	±2%	150mV	81%	60W
	5V, 0~1.5A	±5%	50mV		

65W RPT-65

Model No.	Output	Tol.	R&N	Effi.	Max.
RPT-65E	12V, 0.18~5.8A	±2%	120mV	77%	63W
	5V, 0.0~1.5A	±5%	100mV		
	-5V, 0.0~0.7A	±5%	120mV		
RPT-65F	12V, 0.18~5.8A	±2%	150mV	77%	66W
	5V, 0.0~1.5A	±5%	100mV		
	-12V, 0.0~0.7A	±5%	150mV		
RPT-65G	24V, 0.09~2.9A	±2%	150mV	81%	66W
	5V, 0.0~1.5A	±5%	50mV		
	12V, 0.0~0.7A	±5%	100mV		

125W PPT-125

Model No.	Output	Tol.	R&N	Effi.	Max.
PPT-125A	3.3V, 1.0~12.5A	±3%	100mV	75%	99W
	5V, 0.8~10.0A	±5%	100mV		
	12V, 0.05~0.63A	±6%	120mV		
PPT-125B	5V, 1.0~14.38A	±3%	100mV	78%	124W
	12V, 0.3~3.75A	±5%	120mV		
	-12V, 0.05~0.63A	±6%	120mV		
PPT-125C	5V, 1.0~13.75A	±3%	100mV	78%	125W
	15V, 0.25~3.13A	±5%	150mV		
	-15V, 0.05~0.63A	±6%	150mV		
PPT-125D	5V, 1.0~8.75A	±3%	100mV	78%	126W
	24V, 0.25~3.13A	±5%	240mV		
	12V, 0.05~0.63A	±6%	120mV		

250W PID-250

Model No.	Output	Tol.	R&N	Effi.
PID-250A	12V, 0~15A	±3%	120mV	83%
	5V, 0~5.0A	±2%	50mV	
PID-250B	24V, 0~9.4A	±2%	150mV	86%
	5V, 0~5.0A	±2%	50mV	
PID-250C	36V, 0~6.3A	±2%	200mV	86%
	5V, 0~5.0A	±2%	50mV	
PID-250D	48V, 0~4.7A	±2%	200mV	86%
	5V, 0~5.0A	±2%	50mV	



Features

- Universal AC input / Full range
- No load power consumption <0.1W (<0.3W for 15~35W)
- High efficiency up to 91%
- Compact size, 1U low profile
- Cooling by free air convection
- Protections: Short circuit / Overload / Over voltage
- **Class I or Class II installations**
- LED indicator for power on (EPS-25/35/45S/65S)
- Operating altitude 2000~5000 meters by model
- 3 years warranty

General Specification (Please refer to www.meanwell.com for detail spec.)



Model No.	EPS-15	EPS-25	EPS-35	EPS-45S	EPS-65S
AC input voltage range	85~264VAC; 120~370VDC			80~264VAC	
AC inrush current (max.)	Cold start, 45A at 230VAC	Cold start, 35A at 230VAC	Cold start, 40A at 230VAC	Cold start, 60A at 230VAC	
DC adjustment range	±10% rated output voltage			-5~+10% rated output voltage	
Overload protection	Range	115%~150% rated output power	115%~170% rated output power	115%~150% rated output power	
	Type	Hiccup mode, auto-recovery			
Over voltage protection	110%~135% shut down o/p voltage, re-power on to recover				
Withstand voltage	I/P-O/P: 3kVAC, I/P-FG:2kVAC, O/P-FG: 0.5kVAC				
Working temperature	-30~+70°C (refer to output derating curve)				
Safety standards	UL62368-1, TUV BS EN/EN62368-1, EN60335-1(EPS-45S/65S), EAC TP TC 004 approved; CCC GB4943.1 for EPS-15				
EMC standards	BS EN/EN55032 class B, EN61000-3-2,3, EN61000-4-2,3,4,5,6,8,11, EAC TP TC 020 (GB9254, GB17625.1 for EPS-15)				
Connection	JST B3P/B2P-VH			JST B3P/B4P-VH	
Dimension (LxWxH)(mm)	63.5x45.7x24		76.2x50.8x24		

15W—Class I EPS-15

Model No.	Output (Rated / Peak 10 sec.)	Tol.	R&N	Effi.
EPS-15-3.3	3.3V, 0~3A / 3.3A	±2%	50mV	75%
EPS-15-5	5V, 0~3A / 3.3A	±2%	50mV	78%
EPS-15-7.5	7.5V, 0~2A / 2.2A	±2%	80mV	81%
EPS-15-12	12V, 0~1.25A / 1.38A	±1%	80mV	82%
EPS-15-15	15V, 0~1A / 1.1A	±1%	100mV	83%
EPS-15-24	24V, 0~0.625A / 0.69A	±1%	150mV	83%
EPS-15-27	27V, 0~0.56A / 0.615A	±1%	180mV	84%
EPS-15-36	36V, 0~0.42A / 0.46A	±1%	200mV	85%
EPS-15-48	48V, 0~0.313A / 0.344A	±1%	200mV	85%

25W—Class I EPS-25

Model No.	Output (Rated / Peak 10 sec.)	Tol.	R&N	Effi.
EPS-25-3.3	3.3V, 0~5A / 5.5A	±2%	60mV	79%
EPS-25-5	5V, 0~5A / 5.5A	±2%	60mV	81%
EPS-25-7.5	7.5V, 0~3.4A / 3.74A	±2%	80mV	83%
EPS-25-12	12V, 0~2.1A / 2.34A	±1%	100mV	86%
EPS-25-15	15V, 0~1.7A / 1.87A	±1%	100mV	87%
EPS-25-24	24V, 0~1.05A / 1.17A	±1%	180mV	88%
EPS-25-27	27V, 0~0.95A / 1.05A	±1%	180mV	89%
EPS-25-36	36V, 0~0.7A / 0.78A	±1%	200mV	89%
EPS-25-48	48V, 0~0.53A / 0.59A	±1%	240mV	90%

35W—Class I EPS-35

Model No.	Output (Rated / Peak 10 sec.)	Tol.	R&N	Effi.
EPS-35-3.3	3.3V, 0~6A / 6.6A	±2.5%	60mV	80%
EPS-35-5	5V, 0~6A / 6.6A	±2.0%	70mV	82%
EPS-35-7.5	7.5V, 0~4.7A / 5.2A	±2.0%	80mV	84%

Model No.	Output (Rated / Peak 10 sec.)	Tol.	R&N	Effi.
EPS-35-12	12V, 0~3A / 3.3A	±1.0%	100mV	87%
EPS-35-15	15V, 0~2.4A / 2.65A	±1.0%	100mV	88%
EPS-35-24	24V, 0~1.5A / 1.65A	±1%	180mV	89%
EPS-35-27	27V, 0~1.3A / 1.45A	±1%	180mV	89%
EPS-35-36	36V, 0~1A / 1.1A	±1%	200mV	89%
EPS-35-48	48V, 0~0.75A / 0.82A	±1%	240mV	90%

45W—Class II EPS-45S

Model No.	Output (Rated / Peak 10 sec.)	Tol.	R&N	Effi.
EPS-45S-3.3	3.3V, 0~8A / 8.8A	±2%	80mV	80%
EPS-45S-5	5V, 0~8A / 8.8A	±2%	80mV	83%
EPS-45S-7.5	7.5V, 0~5.4A / 5.95A	±2%	80mV	85%
EPS-45S-12	12V, 0~3.8A / 4.18A	±2%	120mV	88%
EPS-45S-15	15V, 0~3A / 3.3A	±2%	150mV	89%
EPS-45S-24	24V, 0~1.9A / 2.1A	±1%	240mV	90%
EPS-45S-48	48V, 0~0.94A / 1.03A	±1%	300mV	91%

65W—Class II EPS-65S

Model No.	Output (Rated / Peak 10 sec.)	Tol.	R&N	Effi.
EPS-65S-3.3	3.3V, 0~10A / 11A	±2%	80mV	80%
EPS-65S-5	5V, 0~10A / 11A	±2%	80mV	84%
EPS-65S-7.5	7.5V, 0~8A / 8.8A	±2%	80mV	85%
EPS-65S-12	12V, 0~5.42A / 5.96A	±2%	120mV	88%
EPS-65S-15	15V, 0~4.34A / 4.77A	±2%	150mV	89%
EPS-65S-24	24V, 0~2.71A / 2.98A	±1%	240mV	90%
EPS-65S-48	48V, 0~1.36A / 1.49A	±1%	300mV	91%

Green Open Frame 45~120W Single Output Industrial Grade



Features

- Compact size, 1U low profile
- Universal AC input / Full range
- Class I or Class II installations
- No load power consumption < 0.3W
- High efficiency up to 94%
- Protections: Short circuit / Overload / Over voltage / Over temp.(EPP-120S)
- Cooling by free air convection
- Built-in 12V/0.5A auxiliary output (EPS-120)
- LED indicator for power on
- Operating altitude up to 5000 meters (EPP-120S)
- 3 years warranty

General Specification (Please refer to www.meanwell.com for detail spec.)



Model No.	EPP-120S	EPS-45-x <input type="checkbox"/>	EPS-65-x <input type="checkbox"/>	EPS-120
Rated Power	Fan	NA	NA	120W (10CFM)
	Convection	120W	45W	84W
AC input voltage range	80~264VAC		90~264VAC	80~264VAC
DC adjustment range	±5% rated output voltage		±10% rated output voltage	
Overload protection	Range	130%~160%	115%~150% rated output power	
	Type	Hiccup mode, auto-recovery		
Over voltage protection	Range	110%~130%		
	Type	Shut down o/p voltage, re-power on to recover		
Withstand voltage	I/P-O/P: 4kVAC, I/P-FG:2kVAC, O/P-FG: 1.5kVAC, 1 minute		I/P-O/P: 3kVAC, I/P-FG:2kVAC, O/P-FG: 0.5kVAC, 1 minute	
Working temperature	-30~+85°C		-30~+70°C (refer to output derating curve)	
Safety standards	UL62368-1, TUV BS EN/EN62368-1, EAC TP TC 004, EN60335-1(EPP-120S only) approved			
EMC standards	BS EN/EN55032 class B, EN61000-3-2,3, EN61000-4-2,3,4,5,6,8,11, EAC TP TC 020			
Connection	JST B3P/B4P-VH		3+4P/3.96mm pitch, JST B3P/B4P-VH	
Dimension (LxWxH)(mm)	76.2x 50.8x 28		PCB: 101.6x50.8x29 ; Case: 103.4x62x37	

120W—Class I or II EPP-120S

Model No.	Output (Convection/Peak 10 sec.)	Tol.	R&N	Effi.
EPP-120S-12	12V, 9.5A / 11.8A	±2%	100mV	91%
EPP-120S-15	15V, 7.6A / 9.5A	±2%	120mV	92%
EPP-120S-24	24V, 5A / 6.25A	±1%	150mV	93%
EPP-120S-27	27V, 4.44A / 5.55A	±1%	150mV	94%
EPP-120S-48	48V, 2.5A / 3.125A	±1%	200mV	93.5%

45W—Class I EPS-45

Model No.	Output (Rated / Peak 10 sec.)	Tol.	R&N	Effi.
EPS-45-3.3 <input type="checkbox"/>	3.3V, 8A / 9A	±3%	80mV	80%
EPS-45-5 <input type="checkbox"/>	5V, 8A / 9A	±2%	80mV	83%
EPS-45-7.5 <input type="checkbox"/>	7.5V, 5.4A / 5.6A	±2%	100mV	85%
EPS-45-12 <input type="checkbox"/>	12V, 3.75A / 4.2A	±2%	120mV	88%
EPS-45-15 <input type="checkbox"/>	15V, 3A / 3.3A	±2%	150mV	89%
EPS-45-24 <input type="checkbox"/>	24V, 1.9A / 2.1A	±1%	240mV	90%
EPS-45-36 <input type="checkbox"/>	36V, 1.25A / 1.4A	±1%	280mV	90%
EPS-45-48 <input type="checkbox"/>	48V, 1A / 1.1A	±1%	300mV	91%

= blank, -C ; blank: PCB type, -C: Enclosed type

65W—Class I EPS-65

Model No.	Output (Rated / Peak 10 sec.)	Tol.	R&N	Effi.
EPS-65-3.3 <input type="checkbox"/>	3.3V, 11A / 12A	±3%	80mV	80%
EPS-65-5 <input type="checkbox"/>	5V, 11A / 12A	±2%	80mV	82%
EPS-65-7.5 <input type="checkbox"/>	7.5V, 8A / 8.8A	±2%	100mV	84%
EPS-65-12 <input type="checkbox"/>	12V, 5.42A / 6A	±2%	120mV	86%
EPS-65-15 <input type="checkbox"/>	15V, 4.34A / 4.8A	±2%	150mV	87%
EPS-65-24 <input type="checkbox"/>	24V, 2.71A / 3A	±1%	240mV	88%
EPS-65-36 <input type="checkbox"/>	36V, 1.81A / 2A	±1%	280mV	89%
EPS-65-48 <input type="checkbox"/>	48V, 1.36A / 1.5A	±1%	300mV	90%

= blank, -C ; blank: PCB type, -C: Enclosed type

120W—Class I or II EPS-120

Model No.	Output (Convection/10CFM)	Tol.	R&N	Effi.
EPS-120-12	12V, 7A / 10A	±2%	120mV	88.0%
EPS-120-15	15V, 5.6A / 8A	±2%	120mV	88.5%
EPS-120-24	24V, 3.5A / 5A	±1%	150mV	90.0%
EPS-120-27	27V, 3.15A / 4.5A	±1%	150mV	90.0%
EPS-120-48	48V, 1.75A / 2.5A	±1%	200mV	91.0%

Green Open Frame

75~200W Single Output Industrial Grade



Features

- Universal AC input / Full range
- Built-in active PFC function
- **Class I or Class II installations**
- No load power consumption <0.5W
- High efficiency up to 94%
- Protections: Short circuit / Overload / Over voltage / Over temperature
- Built-in 12V/0.5A auxiliary output (12V/0.3A for EPP-100/150)
- Standby 5V@1A with fan, @ 0.6A without fan (EPP-300)
- Built-in remote sense function (EPP-300)
- LED indicator for power on
- Operating altitude **up to 5000 meters** (EPP-200)
- 3 years warranty

General Specification (Please refer to www.meanwell.com for detail spec.)



Model No.	ELP-75		EPP-100	EPP-150	EPP-200
Rated Power	Fan	NA	100W (20CFM)	150W (20CFM)	200W (10CFM)
	Convection	75W		100W	140W
AC input voltage range	90~264VAC			80~264VAC	
DC adjustment range	±10%		-2%~+5% rated output voltage		±5% rated output voltage
Overload protection	Range	105%~150%		105%~145%	115%~150%
	Type	Hiccup mode, auto-recovery			
Over voltage protection	Range	110%~130%	115%~135% rated output voltage		110%~130%
	Type	Shut down o/p voltage, re-power on to recover			
Withstand voltage	I/P-O/P: 3kVAC, I/P-FG:1.5kVAC, O/P-FG: 0.5kVAC		I/P-O/P: 3kVAC, I/P-FG:2kVAC, O/P-FG: 0.5kVAC		
Working temperature	-30~+70°C (refer to output derating curve)				
Safety standards	UL62368-1, TUV BS EN/EN62368-1, EAC TP TC 004 approved				
EMC standards	BS EN/EN55011 (EPP-300) / EN55032 class B, EN61000-3-2,3, EN61000-4-2,3,4,5,6,8,11, EAC TP TC 020				
Connection	3+4P/3.96mm pitch, JST B3P / B6P-VH		JST B3P / B4P-VH		JST B3P / B6P-VH
Dimension (LxWxH)(mm)	PCB: 175x 60x 27		101.6x 50.8x 29		

75W—Class I ELP-75

Model No.	Output	Tol.	R&N	Effi.
ELP-75-3.3	3.3V, 15A	±3%	80mV	80%
ELP-75-5	5V, 15A	±2%	80mV	82%
ELP-75-12	12V, 6.25A	±2%	120mV	89%
ELP-75-15	15V, 5A	±2%	150mV	90%
ELP-75-24	24V, 3.15A	±1%	240mV	90%
ELP-75-36	36V, 2.1A	±1%	280mV	90%
ELP-75-48	48V, 1.6A	±1%	300mV	90%

100W—Class I EPP-100

Model No.	Output (Convection/20CFM)	Tol.	R&N	Effi.
EPP-100-12	12V, 6.3A / 8.5A	±2%	120mV	91.0%
EPP-100-15	15V, 5A / 6.67A	±2%	150mV	91.0%
EPP-100-24	24V, 3.2A / 4.2A	±1%	240mV	92.0%
EPP-100-27	27V, 2.8A / 3.71A	±1%	240mV	92.5%
EPP-100-48	48V, 1.6A / 2.1A	±1%	300mV	92.5%

150W—Class I EPP-150

Model No.	Output (Convection/20CFM)	Tol.	R&N	Effi.
EPP-150-12	12V, 8.4A / 12.5A	±2%	130mV	91.5%
EPP-150-15	15V, 6.7A / 10.0A	±2%	150mV	92.0%
EPP-150-24	24V, 4.2A / 6.25A	±1%	240mV	93.0%
EPP-150-27	27V, 3.71A / 5.56A	±1%	240mV	92.0%
EPP-150-48	48V, 2.1A / 3.125A	±1%	300mV	92.0%

200W—Class I or II EPP-200

Model No.	Output (Convection/10CFM)	Tol.	R&N	Effi.
EPP-200-12	12V, 11.7A / 16.7A	±2%	100mV	93%
EPP-200-15	15V, 9.4A / 13.4A	±2%	100mV	93%
EPP-200-24	24V, 5.9A / 8.4A	±1%	150mV	94%
EPP-200-27	27V, 5.3A / 7.5A	±1%	150mV	94%
EPP-200-48	48V, 3A / 4.2A	±1%	200mV	94%

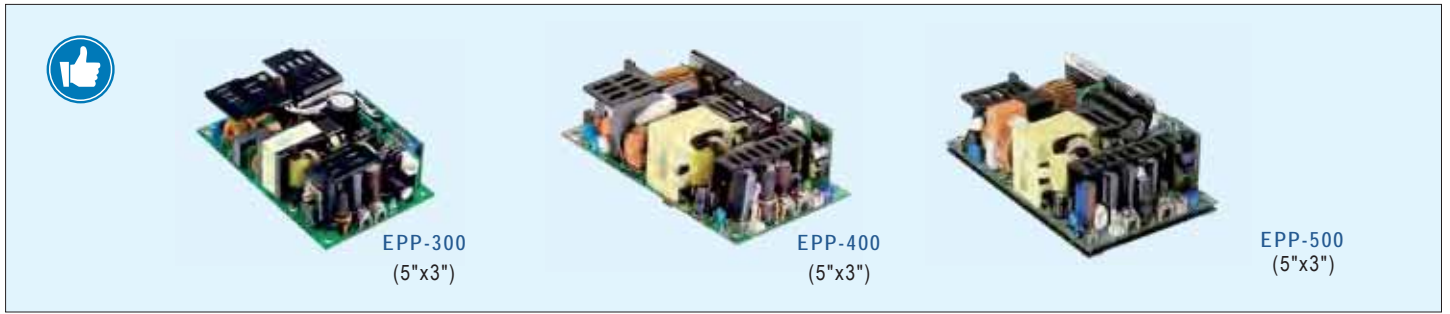

Features

- Universal AC input / Full range
- Built-in active PFC function
- **Class I or Class II installations**
- No load power consumption <0.5W
- High efficiency up to 94%
- Protections: Short circuit / Overload / Over voltage / Over temperature
- 12V/0.5A auxiliary output
- Standby @ 0.6A without fan
- P.G/P.F, remote sense function
- LED indicator for power on
- Operating altitude up to 5000 meters
- 3 years warranty

General Specification (Please refer to www.meanwell.com for detail spec.)



Model No.		EPP-300	EPP-400	EPP-500
Rated Power	Fan	300W (20.5CFM)	400W (25CFM)	500W (25CFM)
	Convection	200W	250W	320W
AC input voltage range		90~264VAC	80~264VAC	
DC adjustment range		±5% rated output voltage, EAC TP TC 004		
Overload protection	Range	105%~135%	115%~135%	105%~135%
	Type	Hiccup mode, auto-recovery		
Over voltage protection	Range	115%~135% rated output voltage	110%~130%	
	Type	Shut down o/p voltage, re-power on to recover		
Withstand voltage		I/P-O/P: 3kVAC, I/P-FG:2kVAC, O/P-FG: 0.5kVAC	I/P-O/P: 3kVAC, I/P-FG:2kVAC, O/P-FG: 1.5kVAC	
Working temperature		-30~+70°C (refer to output derating curve)		
Safety standards		UL62368-1, TUV BS EN/EN62368-1, EAC TP TC 004, CCC GB4943.1(EPP-400 only), EN60335-1(EPP-400/500 only) approved		
EMC standards		BS EN/EN55032 class B, EN61000-3-2,3, EN61000-4-2,3,4,5,6,8,11, EAC TP TC 020		
Connection		JST B5P-VH / Screw terminal		
Dimension (LxWxH)(mm)		127x 76.2x 35		127x 76.2x 41

300W—Class I EPP-300

Model No.	Output (Convection/20.5CFM)	Tol.	R&N	Effi.
EPP-300-12	12V, 16.67A / 25.0A	±3%	120mV	90.0%
EPP-300-15	15V, 13.33A / 20.0A	±3%	120mV	90.0%
EPP-300-24	24V, 8.33A / 12.5A	±2%	150mV	92.5%
EPP-300-27	27V, 7.4A / 11.12A	±2%	200mV	93.0%
EPP-300-48	48V, 4.17A / 6.25A	±2%	250mV	93.0%

400W—Class I or II EPP-400

Model No.	Output (Convection/25CFM)	Tol.	R&N	Effi.
EPP-400-12	12V, 20.8A / 33.3A	±3%	120mV	91.5%
EPP-400-15	15V, 16.7A / 26.7A	±3%	150mV	92%
EPP-400-24	24V, 10.5A / 16.7A	±2%	200mV	93%
EPP-400-27	27V, 9.3A / 14.9A	±1%	200mV	93.5%
EPP-400-36	36V, 7A / 11.2A	±1%	250mV	93%
EPP-400-48	48V, 5.3A / 8.4A	±1%	250mV	94%

500W—Class I or II EPP-500

Model No.	Output (Convection/25CFM)	Tol.	R&N	Effi.
EPP-500-12	12V, 26.7A / 41.6A	±3%	200mV	91%
EPP-500-15	15V, 21.3A / 33.3A	±3%	200mV	92%
EPP-500-18	18V, 17.8A / 27.8A	±3%	200mV	92.5%
EPP-500-24	24V, 13.4A / 20.8A	±2%	200mV	93%
EPP-500-27	27V, 11.9A / 18.5A	±2%	200mV	93.5%
EPP-500-36	36V, 8.9A / 13.9A	±1%	200mV	94%
EPP-500-48	48V, 6.7A / 10.4A	±1%	200mV	94%
EPP-500-54	54V, 5.93A / 9.26A	±1%	200mV	94%

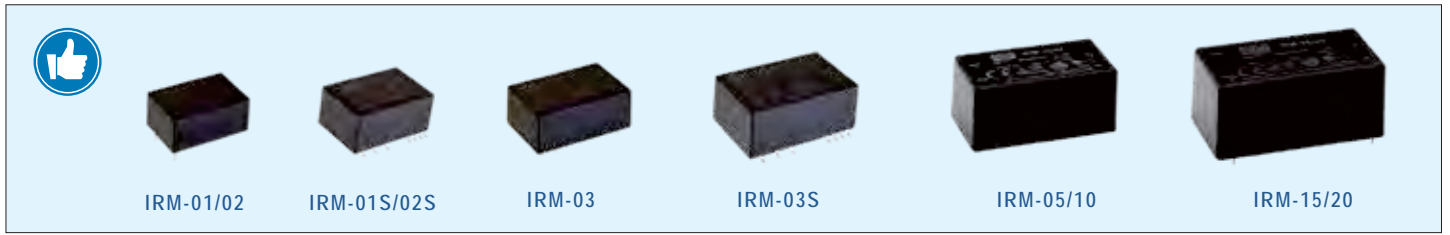

Features

- Universal AC input / up to 305VAC
- No load power consumption < 0.075W (<0.1W for IRM-05~20)
- Miniature size, high power density
- Protections: Short circuit / Overload / Over voltage
- Cooling by free air convection
- Isolation Class II
- Comply with EN55032 class B without any additional components
- Fully isolated plastic case
- High operating temperature up to +85°C
- Withstand 5G vibration test
- Low cost, high reliability
- Pass LPS
- 3 years warranty

General Specification (Please refer to www.meanwell.com for detail spec.)



Model No.	IRM-01-x[S]	IRM-02-x[S]	IRM-03-x[S]	IRM-05	IRM-10	IRM-15	IRM-20
AC input voltage range	85~305VAC						
Overload protection	>110%		105%~260%	115%~260%	115%~190%		115%~160%
Over voltage protection	115%~135% rated output voltage						
Withstand voltage	I/P-O/P: 3kVAC						
Working temperature	-30~+85°C			-30~+70°C (refer to output derating curve)			
Safety standards	IRM-01~20: UL62368-1, TUV BS EN/EN62368-1, EAC TP TC 004, BSMI CNS14336-1 approved; IRM-03(S): TUV BS EN/EN60335-1 approved; Design refer to IEC60601-1 for IRM-03						
EMC standards	BS EN/EN55032 class B, EN61000-3-2,3, EN61000-4-2,3,4,5,6,8,11, EN55024, EAC TP TC 020						
Dimension (LxWxH)(mm)	PCB: 33.7x 22.2x 15 SMD: 33.7x 22.2x 16		PCB: 37x 24x 15 SMD: 37x 24x 16		45.7x 25.4x 21.5		52.4x 27.2x 24

1W IRM-01

Model No.	Output	Tol.	R&N	Effi.
IRM-01-3.3□	3.3V, 0~300mA	±2.5%	150mV	66%
IRM-01-5□	5V, 0~200mA	±2.5%	150mV	70%
IRM-01-9□	9V, 0~111mA	±2.5%	150mV	72%
IRM-01-12□	12V, 0~83mA	±2.5%	150mV	74%
IRM-01-15□	15V, 0~67mA	±2.5%	200mV	75%
IRM-01-24□	24V, 0~42mA	±2.5%	200mV	77%

□ = Blank, S ; Blank: PCB mounting style, S: SMD type

2W IRM-02

Model No.	Output	Tol.	R&N	Effi.
IRM-02-3.3□	3.3V, 0~600mA	±2.5%	150mV	66%
IRM-02-5□	5V, 0~400mA	±2.5%	150mV	70%
IRM-02-9□	9V, 0~222mA	±2.5%	150mV	72%
IRM-02-12□	12V, 0~167mA	±2.5%	150mV	74%
IRM-02-15□	15V, 0~133mA	±2.5%	200mV	75%
IRM-02-24□	24V, 0~83mA	±2.5%	200mV	77%

□ = Blank, S ; Blank: PCB mounting style, S: SMD type

3W IRM-03

Model No.	Output	Tol.	R&N	Effi.
IRM-03-3.3□	3.3V, 0~900mA	±2.5%	100mV	68%
IRM-03-5□	5V, 0~600mA	±2.5%	100mV	72%
IRM-03-9□	9V, 0~333mA	±2.5%	100mV	77%
IRM-03-12□	12V, 0~250mA	±2.5%	150mV	78%
IRM-03-15□	15V, 0~200mA	±2.5%	200mV	78%
IRM-03-24□	24V, 0~125mA	±2.5%	240mV	80%

□ = Blank, S ; Blank: PCB mounting style, S: SMD type

5W IRM-05

Model No.	Output	Tol.	R&N	Effi.
IRM-05-3.3	3.3V, 0~1.25A	±2.5%	200mV	68%
IRM-05-5	5V, 0~1A	±2.5%	200mV	71%
IRM-05-12	12V, 0~0.42A	±2.5%	200mV	75%
IRM-05-15	15V, 0~0.33A	±2.5%	200mV	75%
IRM-05-24	24V, 0~0.23A	±2.5%	200mV	77%

10W IRM-10

Model No.	Output	Tol.	R&N	Effi.
IRM-10-3.3	3.3V, 0~2.5A	±2.5%	200mV	74%
IRM-10-5	5V, 0~2A	±2.5%	200mV	77%
IRM-10-12	12V, 0~0.85A	±2.5%	200mV	82%
IRM-10-15	15V, 0~0.67A	±2.5%	200mV	82%
IRM-10-24	24V, 0~0.42A	±2.5%	200mV	82%

15W IRM-15

Model No.	Output	Tol.	R&N	Effi.
IRM-15-3.3	3.3V, 0~3.5A	±2.5%	200mV	74%
IRM-15-5	5V, 0~3A	±2.5%	200mV	78%
IRM-15-12	12V, 0~1.25A	±2.5%	200mV	82%
IRM-15-15	15V, 0~1A	±2.5%	200mV	82%
IRM-15-24	24V, 0~0.63A	±2.5%	200mV	83%

20W IRM-20

Model No.	Output	Tol.	R&N	Effi.
IRM-20-3.3	3.3V, 0~4.5A	±2.5%	200mV	76%
IRM-20-5	5V, 0~4A	±2.5%	200mV	79%
IRM-20-12	12V, 0~1.8A	±2.5%	200mV	84%
IRM-20-15	15V, 0~1.4A	±2.5%	200mV	84%
IRM-20-24	24V, 0~0.9A	±2.5%	200mV	85%



IRM-30



IRM-30-xST



IRM-45/60/90



IRM-45/60/90-xST

Features

- Universal AC input up to 305VAC
- No load power consumption < 0.1W (<0.21W for IRM-90)
- Miniature size, high power density
- Protections: Short circuit / Overload / Over voltage
- Cooling by free air convection
- Isolation Class II
- Fully isolated plastic case
- Comply with EN55032 class B without any additional components
- High operating temperature up to +80°C
- Withstand 5G vibration test
- Low cost, high reliability
- Pass LPS (except for IRM-45/60 5V and IRM-90)
- Over voltage category III
- 3 years warranty

General Specification (Please refer to www.meanwell.com for detail spec.)



Model No.	IRM-30-x ST	IRM-45-x ST	IRM-60-x ST	IRM-90-x ST
AC input voltage range	85~305VAC			80~305VAC
AC inrush current (max.)	Cold start, 25A at 115VAC, 45A at 230VAC		Cold start, 30A at 115VAC, 60A at 230VAC	
Overload protection	105%~160%		115%~160%	
Over voltage protection	105%~135%			
Setup, rise, hold up time	1000ms, 30ms, 40ms at 230VAC		1000ms, 30ms, 50ms at 230VAC	
Leakage current	<0.25mA at 240VAC			<0.1mA at 240VAC
Withstand voltage	I/P-O/P: 4kVAC			I/P-O/P: 4kVAC
Working temperature	-30~+70°C (refer to output derating curve)			-30~+80°C
Vibration	10~500Hz, 5G 10min./1 cycle, period for 60 min. each along X, Y, Z axes			
Safety standards	UL62368-1, TUV BS EN/EN62368-1, EAC TP TC 004, EN60335-1 approved (IRM-90 by request); BSMI CNS14336-1 (except for IRM-90) approved			
EMC standards	BS EN/EN55032 class B, EN61000-3-2,3, EN61000-4-2,3,4,5,6,8,11, EAC TP TC 020			
Connection	4 industrial pins			
Dimension (LxWxH)(mm)	PCB mounting: 69.5x 39x 24; Screw I/O: 91x 39.5x 28.5		PCB mounting: 87x 52x 29.5; Screw I/O: 109x 52x 33.5	

30W IRM-30

Model No.	Output	Tol.	R&N	Effi.
IRM-30-5□	5V, 0~6A	±2.5%	120mV	83%
IRM-30-12□	12V, 0~2.5A	±2.5%	150mV	88%
IRM-30-15□	15V, 0~2A	±2.5%	200mV	88%
IRM-30-24□	24V, 0~1.3A	±2.5%	240mV	88.5%
IRM-30-48□	48V, 0~0.63A	±2.5%	300mV	90%

□ = Blank, ST ; Blank: PCB mounting style, ST: Screw terminal style

60W IRM-60

Model No.	Output	Tol.	R&N	Effi.
IRM-60-5□	5V, 0~10A	±2.5%	80mV	84%
IRM-60-12□	12V, 0~5A	±2.5%	120mV	87.5%
IRM-60-15□	15V, 0~4A	±2.5%	120mV	89%
IRM-60-24□	24V, 0~2.5A	±2.5%	150mV	90%
IRM-60-48□	48V, 0~1.25A	±2.5%	240mV	91%

□ = Blank, ST ; Blank: PCB mounting style, ST: Screw terminal style

45W IRM-45

Model No.	Output	Tol.	R&N	Effi.
IRM-45-5□	5V, 0~8A	±2.5%	80mV	83.5%
IRM-45-12□	12V, 0~3.8A	±2.5%	150mV	87.5%
IRM-45-15□	15V, 0~3A	±2.5%	180mV	88.5%
IRM-45-24□	24V, 0~1.9A	±2.5%	200mV	89.5%
IRM-45-48□	48V, 0~0.94A	±2.5%	300mV	90.5%

□ = Blank, ST ; Blank: PCB mounting style, ST: Screw terminal style

90W **NEW** IRM-90

Model No.	Output	Tol.	R&N	Effi.
IRM-90-12□	12V, 0~6.7A	±2%	120mV	92%
IRM-90-15□	15V, 0~6.23A	±2%	150mV	92.5%
IRM-90-24□	24V, 0~3.75A	±2%	200mV	93%
IRM-90-48□	48V, 0~1.88A	±2%	240mV	93%

□ = Blank, ST ; Blank: PCB mounting style, ST: Screw terminal style

Green Open Frame

5~30W Medical Miniature PCB-Mount



Features

- Universal AC input / Full range
- **Medical safety (2xMOPP)**
- Suitable for BF application with appropriate system consideration
- Protections: Short circuit / Overload / Over voltage / Over temp.
- Extremely low leakage current
- No load power consumption <0.075W
- **EMI class B** for class II configuration
- **-40~+85°C** wide range working temperature
- Withstand **5G** vibration test
- **Miniature size**, high power density
- Fully isolated plastic case
- 3 years warranty

General Specification (Please refer to www.meanwell.com for detail spec.)



Model No.	MPM-05	MPM-10	MPM-15	MPM-20	MPM-30-x [ST]
AC input voltage range	80~264VAC				
Leakage current	<80μA at 264VAC				
AC inrush current (max.)	Cold start, 25A at 115VAC, 45A at 230VAC				
Overload protection	105%~160% hiccup mode, auto-recovery				
Over voltage protection	105%~135% shut down o/p voltage				
Setup, rise, hold up time	1000ms, 30ms, 40ms at 230VAC			500ms, 30ms, 40ms at 230VAC	
Withstand voltage	I/P-O/P: 4kVAC				
Working temperature	-40~+85°C	-30~+85°C	-40~+85°C	-35~+85°C	-40~+85°C (refer to output derating curve)
Safety standards	BS EN 60601-1, EN60601-1, EAC TP TC 004, UL ANSI/AAMI ES60601, CAN/CSA-C22 3rd edition; EN60335-1 approved for MPM-15/20				
EMC standards	BS EN/EN55011 class B, EN61000-3-2,3, EN61000-4-2,3,4,5,6,8,11, EN60601-1-2				
Connection	4 pins				
Dimension (LxWxH)(mm)	45.7x 25.4x 21.5		52.4x 27.2x 24		PCB mounting: 69.5x 39x 24; Screw I/O: 91x 39.5x 28.5

5W MPM-05

Model No.	Output / Peak(10 sec.)	Tol.	R&N	Effi.
MPM-05-3.3	3.3V, 1.25A / 1.38A	±2.5%	100mV	74%
MPM-05-5	5V, 1.00A / 1.10A	±2.5%	100mV	78%
MPM-05-12	12V, 0.42A / 0.46A	±2.5%	150mV	80%
MPM-05-15	15V, 0.33A / 0.36A	±2.5%	150mV	81%
MPM-05-24	24V, 0.23A / 0.25A	±2.5%	180mV	82%

20W MPM-20

Model No.	Output / Peak(10 sec.)	Tol.	R&N	Effi.
MPM-20-3.3	3.3V, 4.50A / 4.95A	±2%	150mV	81%
MPM-20-5	5V, 4.00A / 4.40A	±2%	150mV	85%
MPM-20-12	12V, 1.80A / 1.98A	±2%	150mV	85.5%
MPM-20-15	15V, 1.40A / 1.54A	±2%	180mV	87%
MPM-20-24	24V, 0.90A / 0.99A	±2%	180mV	87%

10W MPM-10

Model No.	Output / Peak(10 sec.)	Tol.	R&N	Effi.
MPM-10-3.3	3.3V, 2.50A / 2.75A	±2.5%	120mV	78%
MPM-10-5	5V, 2.00A / 2.20A	±2.5%	100mV	81%
MPM-10-12	12V, 0.85A / 0.94A	±2.5%	180mV	83%
MPM-10-15	15V, 0.67A / 0.74A	±2.5%	180mV	83%
MPM-10-24	24V, 0.42A / 0.46A	±2.5%	200mV	84%

30W MPM-30

Model No.	Output / Peak(10 sec.)	Tol.	R&N	Effi.
MPM-30-3.3□	3.3V, 6.00A / 7.8A	±2%	80mV	82.5%
MPM-30-5□	5V, 6.00A / 6.9A	±2%	80mV	86.5%
MPM-30-12□	12V, 2.50A / 2.9A	±2%	120mV	90%
MPM-30-15□	15V, 2.00A / 2.3A	±2%	120mV	89%
MPM-30-24□	24V, 1.30A / 1.5A	±2%	200mV	90%
MPM-30-48□	48V, 0.63A / 0.73A	±2%	200mV	91%

15W MPM-15

Model No.	Output / Peak(10 sec.)	Tol.	R&N	Effi.
MPM-15-3.3	3.3V, 3.50A / 3.85A	±1%	150mV	83.5%
MPM-15-5	5V, 3.00A / 3.30A	±1%	150mV	85.5%
MPM-15-12	12V, 1.25A / 1.38A	±1%	150mV	86.5%
MPM-15-15	15V, 1.00A / 1.10A	±1%	180mV	87.0%
MPM-15-24	24V, 0.63A / 0.69A	±1%	180mV	86.5%

□ = Blank, ST;
Blank: PCB mounting, ST: Screw terminal style



MPM-45/65/90

MPM-45/65/90-xST

Features

- Universal AC input / Full range
- **Medical safety (2xMOPP)**
- Suitable for BF application with appropriate system consideration
- Protections: Short circuit / Overload / Over voltage / Over temp.
- Extremely low leakage current
- No load power consumption <0.1W
- Withstand 5G vibration test
- EMI class B for class II configuration
- -30~+80°C wide range working temperature
- 110% peak power (10 sec.)
- **Miniature size**, high power density
- Fully isolated plastic case
- 3 years warranty

General Specification (Please refer to www.meanwell.com for detail spec.)



Model No.	MPM-45	MPM-65	MPM-90
AC input voltage range	80~264VAC		
Leakage current	<100µA at 264VAC		
AC inrush current (max.)	Cold start, 30A at 115VAC, 60A at 230VAC	Cold start, 30A at 115VAC, 65A at 230VAC	
Overload protection	115%~135% hiccup mode, auto-recovery		115%~160% hiccup mode, auto-recovery
Over voltage protection	105%~135% shut down o/p voltage		
Setup, rise, hole up time	1000ms, 30ms at 230VAC		
Withstand voltage	I/P-O/P: 4kVAC		
Working temperature	-30~+80°C (refer to output derating curve)		
Safety standards	BS EN60601-1, EN60601-1, UL ANSI/AAMI ES60601-1(3.1 version), CAN/CSA-C22 3 Edition approved; EAC TP TC 004, Design refer to EN60335-1(by request)		
EMC standards	BS EN/EN55011 class B, EN61000-3-2,3, EN61000-4-2,3,4,5,6,8,11, EN60601-1-2		
Connection	4 pins		
Dimension (LxWxH)(mm)	PCB mounting: 87x 52x 29.5; Screw I/O: 109x 52x 33.5		

45W MPM-45

Model No.	Output (Rated/Peak10 sec.)	Tol.	R&N	Effi.
MPM-45-5□	5V, 8.00A / 8.8A	±2%	80mV	88.0%
MPM-45-12□	12V, 3.75A / 4.13A	±2%	120mV	91.5%
MPM-45-15□	15V, 3.00A / 3.30A	±2%	120mV	92.5%
MPM-45-24□	24V, 1.88A / 2.10A	±2%	200mV	92.5%
MPM-45-48□	48V, 0.94A / 1.05A	±2%	240mV	92.0%

□ = Blank, ST;
Blank: PCB mounting, ST: Screw terminal style

Model No.	Output (Rated/Peak10 sec.)	Tol.	R&N	Effi.
MPM-65-15□	15V, 4.33A / 4.77A	±2%	120mV	92.5%
MPM-65-24□	24V, 2.71A / 2.98A	±2%	200mV	93.0%
MPM-65-48□	48V, 1.36A / 1.49A	±2%	240mV	92.0%

□ = Blank, ST;
Blank: PCB mounting, ST: Screw terminal style

65W MPM-65

Model No.	Output (Rated/Peak10 sec.)	Tol.	R&N	Effi.
MPM-65-5□	5V, 10A / 11A	±2%	80mV	86.5%
MPM-65-12□	12V, 5.42A / 5.96A	±2%	120mV	92.5%

□ = Blank, ST;
Blank: PCB mounting, ST: Screw terminal style

90W MPM-90

Model No.	Output (Rated/Peak10 sec.)	Tol.	R&N	Effi.
MPM-90-12□	12V, 6.7A / 7.37A	±2%	120mV	92.0%
MPM-90-15□	15V, 5.67A / 6.23A	±2%	150mV	92.5%
MPM-90-24□	24V, 3.75A / 4.13A	±2%	200mV	93.0%
MPM-90-48□	48V, 1.88A / 2.07A	±2%	240mV	93.0%

□ = Blank, ST;
Blank: PCB mounting, ST: Screw terminal style



Features

- Universal AC input / Full range
- **Medical safety (2xMOPP)**
- Suitable for BF application with appropriate system consideration
- Protections: Short circuit / Overload / Over voltage / Over temp.
- Extremely low leakage current
- No load power consumption <0.075W
- **EMI class B** for Class II configuration
- **-40~+85°C** wide range working temperature
- **Miniature size**, high power density
- No minimum load required
- 3 years warranty

General Specification (Please refer to www.meanwell.com for detail spec.)



Model No.	MFM-05	MFM-10	MFM-15	MFM-20	MFM-30
AC input voltage range	80~264VAC				
Leakage current	<80μA at 264VAC				
AC inrush current (max.)	Cold start, 25A at 115VAC, 45A at 230VAC				
Overload protection	105%~160% hiccup mode, auto-recovery			115%~165%	
Over voltage protection	105%~135% shut down o/p voltage			105%~135%	
Setup, rise, hold up time	1000ms, 30ms, 40ms at 230VAC			500ms, 30ms, 40ms at 230VAC	
Withstand voltage	I/P-O/P: 4kVAC				
Working temperature	-40~+85°C	-30~+85°C	-35~+85°C		-40~+85°C (refer to output derating curve)
Safety standards	BS EN 60601-1, EN60601-1, EAC TP TC 004, UL ANSI/AAMI ES60601, CAN/CSA-C22 3rd edition; BS EN/EN 60335-1(MFM-15/20) approved				
EMC standards	BS EN/EN55011 class B, EN61000-3-2,3, EN61000-4-2,3,4,5,6,8,11, EN60601-1-2				
Connection	4 pins				
Dimension (LxWxH)(mm)	42x 22.3x 20.5		49x 23.8x 23		65.5x 35x 23

5W MFM-05

Model No.	Output / Peak(10 sec.)	Tol.	R&N	Effi.
MFM-05-3.3	3.3V, 1.25A / 1.38A	±2.5%	100mV	74%
MFM-05-5	5V, 1.00A / 1.10A	±2.5%	100mV	78%
MFM-05-12	12V, 0.42A / 0.46A	±2.5%	150mV	80%
MFM-05-15	15V, 0.33A / 0.36A	±2.5%	150mV	81%
MFM-05-24	24V, 0.23A / 0.25A	±2.5%	180mV	82%

10W MFM-10

Model No.	Output / Peak(10 sec.)	Tol.	R&N	Effi.
MFM-10-3.3	3.3V, 2.50A / 2.75A	±2.5%	120mV	78%
MFM-10-5	5V, 2.00A / 2.20A	±2.5%	100mV	81%
MFM-10-12	12V, 0.85A / 0.94A	±2.5%	180mV	83%
MFM-10-15	15V, 0.67A / 0.74A	±2.5%	180mV	83%
MFM-10-24	24V, 0.42A / 0.46A	±2.5%	200mV	84%

15W MFM-15

Model No.	Output / Peak(10 sec.)	Tol.	R&N	Effi.
MFM-15-3.3	3.3V, 3.50A / 3.85A	±2%	150mV	83.5%
MFM-15-5	5V, 3.00A / 3.30A	±2%	150mV	85.5%
MFM-15-12	12V, 1.25A / 1.38A	±2%	150mV	86.5%
MFM-15-15	15V, 1.00A / 1.10A	±2%	180mV	87.0%
MFM-15-24	24V, 0.63A / 0.69A	±2%	180mV	86.5%

20W MFM-20

Model No.	Output / Peak(10 sec.)	Tol.	R&N	Effi.
MFM-20-3.3	3.3V, 4.50A / 4.95A	±2%	150mV	81%
MFM-20-5	5V, 4.00A / 4.40A	±2%	150mV	85%
MFM-20-12	12V, 1.80A / 1.98A	±2%	150mV	85.5%
MFM-20-15	15V, 1.40A / 1.54A	±2%	180mV	87%
MFM-20-24	24V, 0.90A / 0.99A	±2%	180mV	87%

30W MFM-30

Model No.	Output / Peak(10 sec.)	Tol.	R&N	Effi.
MFM-30-3.3	3.3V, 6.00A / 7.8A	±2%	80mV	82.5%
MFM-30-5	5V, 6.00A / 6.9A	±2%	80mV	86.5%
MFM-30-12	12V, 2.50A / 2.9A	±2%	120mV	90%
MFM-30-15	15V, 2.00A / 2.3A	±2%	120mV	89%
MFM-30-24	24V, 1.30A / 1.5A	±2%	200mV	90%
MFM-30-48	48V, 0.63A / 0.73A	±2%	200mV	91%

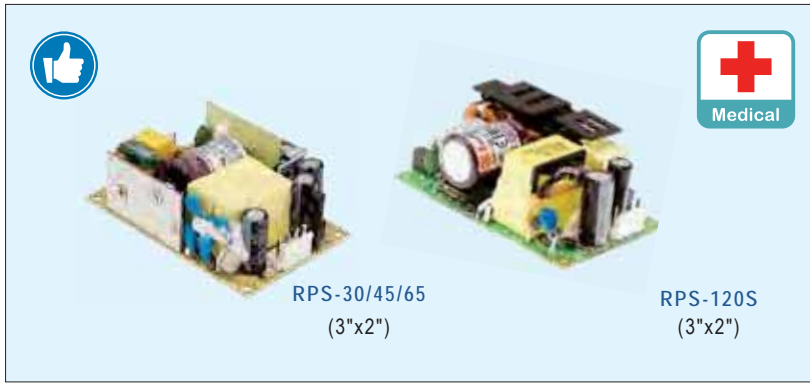

Features

- Universal AC input / Full range
- **Class I or Class II configuration**
- **Medical safety approved (2x MOPP)**
- Suitable for BF application with appropriate system consideration
- Extremely low leakage current
- No load power consumption **<0.1W (<0.3W for RPS-120S)**
- Protections: Short circuit / Overload / Over voltage
- LED indicator for power on
- 3 years warranty

General Specification (Please refer to www.meanwell.com for detail spec.)



Model No.	RPS-30	RPS-45	RPS-65	RPS-120S
Rated Power	Fan NA			
	Convection	30W	45W	65W
AC input voltage range	80~264VAC			
Leakage current	<90µA	<100µA		<150µA
DC adjustment range	±10% rated output voltage			±5% rated output voltage
Overload protection	115%~150% hiccup mode, auto-recovery			
Over voltage protection	115%~135% shut down o/p voltage, re-power on to recover			110%~130%
Withstand voltage	I/P-O/P: 4kVAC, I/P-FG:2kVAC, O/P-FG: 1.5kVAC			
Working temperature	-30~+70°C			-30~+85°C
Safety standards	ANSI/AAMI ES60601-1, TUV BS EN/EN60601-1, EAC TP TC 004 approved			
EMC standards	BS EN/EN55011 class B, EN61000-3-2,-3, EN61000-4,2,3,4,5,6,8,11, EN60601-1-1-2, EAC TP TC 020			
Connection	JST B3P / B2P-VH	JST B3P / B4P-VH		
Dimension (LxWxH)(mm)	76.2x 50.8x 24			76.2x 50.8x 28

30W—Class II RPS-30

Model No.	Output (Rated / Peak)	Tol.	R&N	Effi.
RPS-30-3.3	3.3V, 6A / 6.6A	±2%	80mV	80%
RPS-30-5	5V, 6A / 6.6A	±2%	80mV	82%
RPS-30-7.5	7.5V, 4A / 4.4A	±2%	80mV	84%
RPS-30-12	12V, 2.5A / 2.75A	±2%	100mV	88%
RPS-30-15	15V, 2A / 2.2A	±2%	100mV	89%
RPS-30-24	24V, 1.25A / 1.375A	±1%	150mV	89.5%
RPS-30-48	48V, 0.625A / 0.687A	±1%	150mV	92%

65W—Class II RPS-65

Model No.	Output (Rated / Peak)	Tol.	R&N	Effi.
RPS-65-3.3	3.3V, 10A / 11A	±2%	80mV	80%
RPS-65-5	5V, 10A / 11A	±2%	80mV	84%
RPS-65-7.5	7.5V, 8A / 8.8A	±2%	80mV	85%
RPS-65-12	12V, 5.42A / 5.96A	±2%	120mV	88%
RPS-65-15	15V, 4.34A / 4.77A	±1%	120mV	89%
RPS-65-24	24V, 2.71A / 2.98A	±1%	120mV	90%
RPS-65-48	48V, 1.36A / 1.49A	±1%	150mV	91%

45W—Class II RPS-45

Model No.	Output (Rated / Peak)	Tol.	R&N	Effi.
RPS-45-3.3	3.3V, 8A / 8.8A	±2%	60mV	80.5%
RPS-45-5	5V, 8A / 8.8A	±2%	60mV	83%
RPS-45-7.5	7.5V, 5.4A / 5.95A	±2%	80mV	85%
RPS-45-12	12V, 3.8A / 4.18A	±2%	100mV	88%
RPS-45-15	15V, 3A / 3.3A	±2%	100mV	89%
RPS-45-24	24V, 1.9A / 2.1A	±1%	120mV	90%
RPS-45-48	48V, 0.94A / 1.03A	±1%	120mV	91%

120W—Class I or II RPS-120S

Model No.	Output (Rated / Peak)	Tol.	R&N	Effi.
RPS-120S-12	12V, 9.5A / 11.8A	±2%	100mV	91%
RPS-120S-15	15V, 7.6A / 9.5A	±2%	120mV	92%
RPS-120S-24	24V, 5A / 6.25A	±1%	150mV	93%
RPS-120S-27	27V, 4.44A / 5.55A	±1%	150mV	94%
RPS-120S-48	48V, 2.5A / 3.125A	±1%	200mV	93.5%



Features

- Universal AC input / Full range
- **Class I or Class II configuration**
- **Medical safety approved (2x MOPP)**
- Suitable for BF application with appropriate system consideration
- Extremely low leakage current
- High efficiency up to 95%
- Built-in 12V/0.5A fan supply (RPS-120/200)
- LED indicator for power on (except for RPS/D/T-60)
- No load power consumption <0.3W for 120W model
<0.5W for 200W model
<0.75W for 60W model
- Protections: Short circuit / Overload /
Over voltage / Over temperature
- 3 years warranty

General Specification (Please refer to www.meanwell.com for detail spec.)



Model No.	RPS/D/T-60	RPS-120-x <input type="checkbox"/>	RPS-200-x <input type="checkbox"/>
Rated Power	Fan	NA	120W (10CFM)
	Convection	60W	84W
AC input voltage range	90~264VAC	80~264VAC	
Leakage current	<130µA	<150µA	<130µA
DC adjustment range	-5%~+10%	±5% rated output voltage	
Overload protection	115%~150% hiccup mode, auto-recovery		
Over voltage protection	115%~135%	110%~130% shut down o/p voltage, re-power on to recover	
Withstand voltage	I/P-O/P: 4kVAC, I/P-FG:2kVAC, O/P-FG: 1.5kVAC		
Working temperature	-20~+70°C(RPS), -20~+65°C(RPD/T)	-30~+70°C	
Safety standards	ANSI/AAMI ES60601-1, TUV BS EN/EN60601-1, EAC TP TC 004 approved; UL/EN62368-1 for RPS/D/T-60 only		
EMC standards	BS EN/EN55032 (RPS/D/T-60), EN55011 class B, EN61000-3-2,-3, EN61000-4,2,3,4,5,6,8,11, EN60601-1-1-2, EAC TP TC 020		
Connection	JST B3P / B4P-VH (RPS-60) JST B3P / B6P-VH (RPD/T-60)	JST B3P / B4P-VH	JST B3P / B6P-VH
Dimension (LxWxH)(mm)	101.6x 50.8x 29	PCB: 101.6x 50.8x 29 ; Case: 103.4x 62x 40	

60W:Single Output—Class I RPS-60

Model No.	Output (Rated / Peak)	Tol.	R&N	Effi.
RPS-60-3.3	3.3V, 10A / 11A	±2%	60mV	74%
RPS-60-5	5V, 10A / 11A	±2%	60mV	79%
RPS-60-12	12V, 5A / 5.5A	±2%	120mV	84%
RPS-60-15	15V, 4A / 4.4A	±2%	120mV	85%
RPS-60-24	24V, 2.5A / 2.75A	±1%	120mV	87%
RPS-60-48	48V, 1.25A / 1.375A	±1%	120mV	86%

Model No.	Output	Tol.	R&N	Effi.	Max.
RPT-60A	5V, 0.5~4.4A	+3%, -2%	80mV	77%	51W
RPT-60D	5V, 0.5~3.85A	+3%, -2%	80mV	79%	52W
RPT-6003	24V, 0.1~1.1A	±6%	150mV	75%	44W
	12V, 0.1~0.55A	±8%	80mV		
	3.3V, 0.5~5.5A	+3%, -2%	80mV		
	5V, 0.3~3.3A	±8%	80mV		
	12V, 0.1~0.77A	+10%, -6%	80mV		

60W:Dual Output—Class I RPD-60

Model No.	Output	Tol.	R&N	Effi.	Max.
RPD-60A	5V, 0.5~5.5A	+3%, -2%	80mV	78%	54W
	12V, 0.1~2.2A	±6%	80mV		
RPD-60B	5V, 0.5~3.85A	+3%, -2%	80mV	82%	59W
	24V, 0.1~1.65A	+8%, -4%	100mV		

120W—Class I or II RPS-120

Model No.	Output (Convection/10CFM)	Tol.	R&N	Effi.
RPS-120-12 <input type="checkbox"/>	12V, 7A / 10A	±2%	100mV	89%
RPS-120-15 <input type="checkbox"/>	15V, 5.6A / 8A	±2%	120mV	89%
RPS-120-24 <input type="checkbox"/>	24V, 3.5A / 5A	±1%	150mV	90%
RPS-120-27 <input type="checkbox"/>	27V, 3.15A / 4.5A	±1%	150mV	90%
RPS-120-48 <input type="checkbox"/>	48V, 1.75A / 2.5A	±1%	150mV	91%

= blank, -C ; blank: PCB type, -C: Enclosed type

60W:Triple Output—Class I RPT-60

Model No.	Output	Tol.	R&N	Effi.	Max.
RPT-60A	5V, 0.5~4.4A	+3%, -2%	80mV	77%	51W
	12V, 0.1~2.2A	±6%	80mV		
	-5V, 0.1~0.55A	+9%, -8%	80mV		
RPT-60B	5V, 0.5~4.4A	+3%, -2%	80mV	78%	55W
	12V, 0.1~2.2A	±6%	80mV		
RPT-60C	-12V, 0.1~0.55A	+10%, -6%	100mV		
	5V, 0.5~4.4A	+3%, -2%	80mV	79%	55W
	15V, 0.1~0.65A	±6%	100mV		
	-15V, 0.1~0.55A	±8%	150mV		

200W—Class I or II RPS-200

Model No.	Output (Convection/10CFM)	Tol.	R&N	Effi.
RPS-200-12 <input type="checkbox"/>	12V, 11.7A / 16.7A	±2%	100mV	93%
RPS-200-15 <input type="checkbox"/>	15V, 9.4A / 13.4A	±2%	100mV	93.5%
RPS-200-24 <input type="checkbox"/>	24V, 5.9A / 8.4A	±1%	120mV	94%
RPS-200-27 <input type="checkbox"/>	27V, 5.3A / 7.5A	±1%	120mV	94%
RPS-200-48 <input type="checkbox"/>	48V, 3A / 4.2A	±1%	120mV	95%

= blank, -C ; blank: PCB type, -C: Enclosed type

Green Open Frame 75~160W 1~3 Output Medical Grade

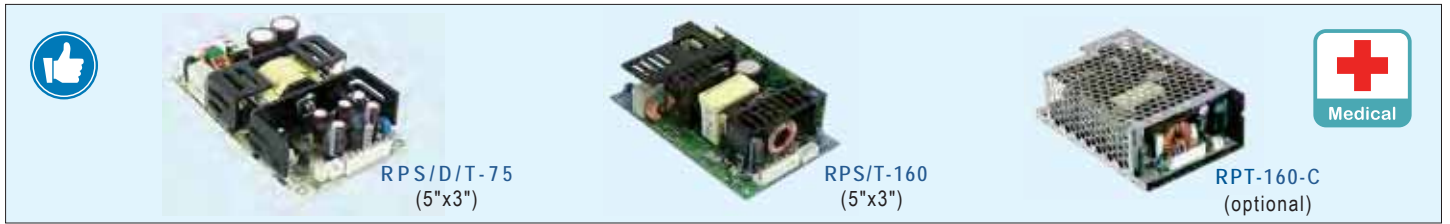

Features

- Universal AC input / Full range
- **Medical safety approved (2xMOPP)**
- Suitable for BF application with appropriate system consideration (RPS/T-160)
- Built-in active PFC function (RPS/T-160)
- Protections: Short circuit / Overload / Over voltage / Over temperature (RPS/T-160)
- Extremely low leakage current
- Built-in P.G and P.F signal output (RPS/T-160)
- Built-in remote sense function (RPS-160 5~15V)
- No load power consumption <0.75W (RPS-75&RPS/T-160 G model)
- Standby 5V@0.8A (RPS/T-160 G model)
- LED indicator for power on
- 3 years warranty

General Specification (Please refer to www.meanwell.com for detail spec.)



Model No.	RPS/D/T-75	RPS□-160	RPT□-160 ○
Rated Power	Fan: 100W (23.5CFM) Convection: 75W	160W (20.5CFM) 110W	RPT(G)-160:145W (20.5CFM), RPT(G)-160-C: 142W (20.5CFM) RPT(G)-160: 99W, RPT(G)-160-C: 94W
AC input voltage range	90~264VAC		
Leakage current	<150μA		<160μA
DC adjustment range	CH1: -5%~+10% rated output voltage	±10%	0~+10%
Overload protection	140%~180% hiccup mode, auto-recovery	105%~135% hiccup mode, auto-recovery	
Over voltage protection	CH1: 110%~135% shut down o/p voltage, re-power on to recover		
Withstand voltage	I/P-O/P: 4kVAC, I/P-FG:2kVAC, O/P-FG: 1.5kVAC		
Working temperature	-20~+70°C (refer to output derating curve)		
Safety standards	ANSI/AAMI ES60601-1, TUV BS EN/EN60601-1, EAC TP TC 004 approved		
EMC standards	BS EN/EN55011 class B, EN61000-3-2,-3; EN60601-1-2, EAC TP TC 020		
Connection	JST B3P / B8P-VH		
Dimension (LxWxH)(mm)	127x 76.2x 31	127x 76.2x 34.6	

75W:Single Output—Class I RPS-75

Model No.	Output (Rated / 23.5CFM)	Tol.	R&N	Effi.
RPS-75-3.3	3.3V, 15A / 20A	±2%	60mV	73%
RPS-75-5	5V, 14A / 18.7A	±2%	60mV	78%
RPS-75-12	12V, 6.3A / 8.3A	±1%	100mV	82%
RPS-75-15	15V, 5A / 6.7A	±1%	100mV	83%
RPS-75-24	24V, 3.2A / 4.2A	±1%	150mV	85%
RPS-75-36	36V, 2.1A / 2.8A	±1%	150mV	86%
RPS-75-48	48V, 1.6A / 2.1A	±1%	150mV	86%

75W:Dual Output—Class I RPD-75

Model No.	Output	Tol.	R&N	Effi.	Max.
RPD-75A	5V, 1.0~9.5A 12V, 0.3~4.0A	±2% ±6%	80mV 120mV	77%	96W
RPD-75B	5V, 1.0~6.8A 24V, 0.2~2.7A	±2% ±6%	80mV 120mV	79%	99W

75W:Triple Output—Class I RPT-75

Model No.	Output	Tol.	R&N	Effi.	Max.
RPT-75A	5V, 0.6~8.0A 12V, 0.2~4.0A	±2% ±6%	80mV 120mV	76%	93W
RPT-75B	-5V, 0.1~1.0A 5V, 0.6~8.0A 12V, 0.2~4.0A	±5% ±2% ±6%	80mV 80mV 120mV	77%	100W
RPT-75C	-12V, 0.1~1.0A 5V, 0.6~8.0A 15V, 0.1~3.0A	±5% ±2% ±8%	80mV 80mV 120mV	77%	100W
RPT-75D	-15V, 0.1~1.0A 5V, 0.6~7.0A 24V, 0.1~2.0A	±5% ±2% ±8%	80mV 80mV 200mV	79%	95W
RPT-7503	12V, 0.1~1.0A 3.3V, 0.7~7.0A 5V, 0.0~8.0A 12V, 0.0~1.5A	±8% ±4% ±6% +10%, -6%	120mV 80mV 120mV 120mV	74%	81W

160W:Single Output—Class I RPS-160

Model No.	Output (Convection / 20.5CFM)	Tol.	R&N	Effi.
RPS□-160-5	5V, 20A / 30A	±4%	80mV	86%
RPS□-160-12	12V, 9.1A / 12.9A	±3%	80mV	87%
RPS□-160-15	15V, 7.3A / 10.3A	±3%	120mV	87%
RPS□-160-24	24V, 4.6A / 6.5A	±2%	120mV	87%
RPS□-160-48	48V, 2.3A / 3.25A	±2%	150mV	88%

□ = blank, G; blank: basic function,
G: with 5Vsb & no load power consumption < 0.5W

160W:Triple Output—Class I RPT-160

Model No.	Output	Tol.	R&N	Effi.	Max.
RPT□-160A○	5V, 0.6~14A 12V, 0.2~5.5A	±2% ±5%	60mV 80mV	84%	145W
RPT□-160B○	-5V, 0.1~1.0A 5V, 0.6~14A 12V, 0.2~5.0A	-5%, +7% ±2% ±5%	120mV 60mV 100mV	84%	146W
RPT□-160C○	-12V, 0.1~1.0A 5V, 0.6~14A 15V, 0.1~3.6A	-4%, +5% ±2% ±4%	100mV 60mV 80mV	83%	143W
RPT□-160D○	-15V, 0.1~1.0A 5V, 0.3~11A 12V, 0.2~5.0A 24V, 0.15~1.2A	±8% ±2% ±5% -5%, +7%	100mV 80mV 100mV 120mV	83%	148W

□ = blank, G; blank: basic function,
G: with 5Vsb/0.8A & no load power consumption < 0.75W
○ = blank, -C; blank: PCB type (standard); -C: Enclosed type (optional)

Green Open Frame 300~400W Single Output Medical Grade

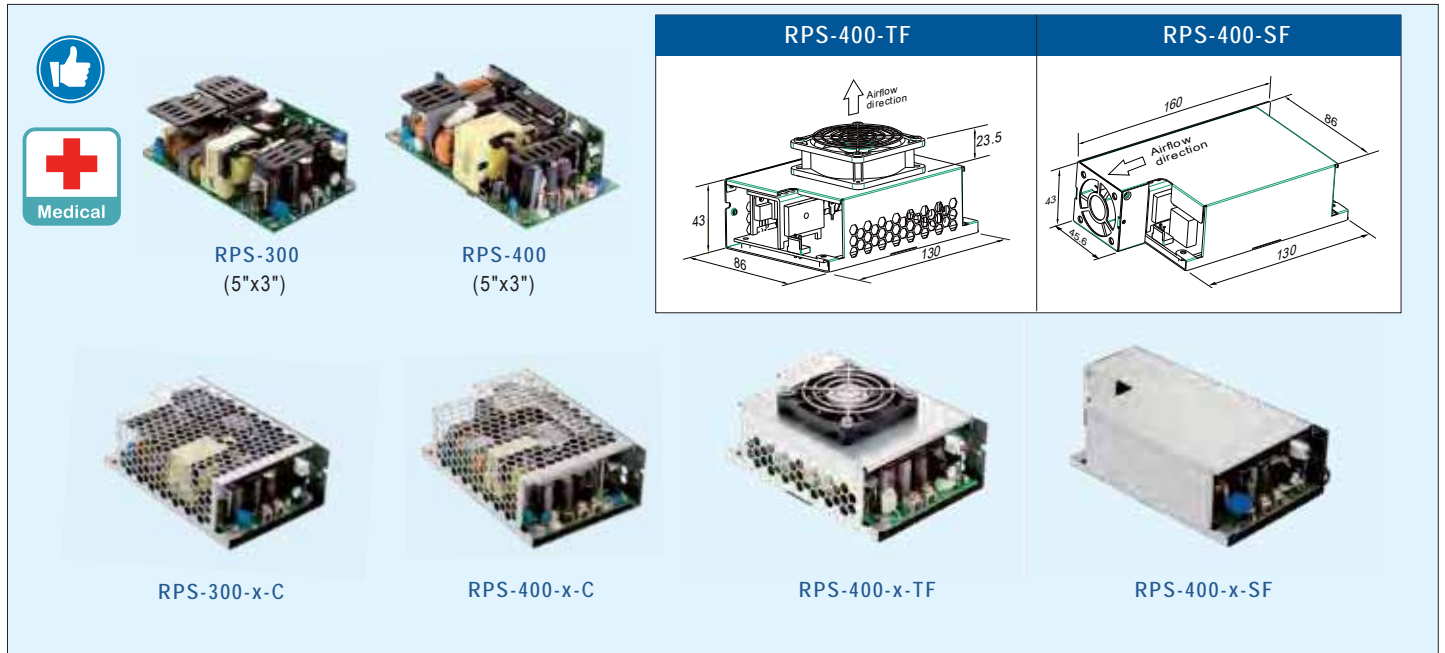

Features

- Universal AC input / Full range
- Built-in active PFC function
- **Medical safety approved (2xMOPP)**
- Suitable for BF application with appropriate system consideration
- Class I or Class II configuration
- Protections:
 - Short circuit / Overload / Over voltage / Over temperature
- Extremely low leakage current
- Built-in P.G, P.F signal output and remote sense function
- No load power consumption **<0.5W by PS-ON only**
- Built-in 12V/0.5A fan supply
- Standby 5V@1A
- LED indicator for power on
- 3 years warranty

General Specification (Please refer to www.meanwell.com for detail spec.)



Model No.		RPS-300-x <input type="checkbox"/>	RPS-400-x <input type="checkbox"/>
Rated Power	Fan	300W (20.5CFM)	400W (25CFM)
	Convection	200W	250W
AC input voltage range		90~264VAC	80~264VAC
Leakage current		PCB type: <150µA; Enclosed type: <200µA	<200µA
DC adjustment range		±5%	
Overload protection		105%~135% hiccup mode, auto-recovery	
Withstand voltage		I/P-O/P: 4kVAC, I/P-FG:2kVAC, O/P-FG: 1.5kVAC	
Working temperature		-30~+70°C (refer to output derating curve)	
Safety standards		ANSI/AAMI ES60601-1, TUV BS EN/EN60601-1, EAC TP TC 004 approved; EN60335-1 approved for RPS-300	
EMC standards		BS EN/EN55011 class B (Radiation class A), EN61000-3-2,-3; EN60601-1-2, EAC TP TC 020	
Connection		JST B5P / screw terminal	
Dimension (LxWxH)(mm)		PCB : 127x 76.2x 35 (5"x3") Case: 130x 86x 43	PCB : 127x 76.2x 35 (5"x3") Case: 130x 86x 43(-C); 130x 86x 66.5(-TF); 160x 86x 43(-SF)

300W—Class I RPS-300

Model No.	Output (Convection / 20.5CFM)	Tol.	R&N	Effi.
RPS-300-12 <input type="checkbox"/>	12V, 16.67A / 25A	±3%	120mV	90.0%
RPS-300-15 <input type="checkbox"/>	15V, 13.33A / 20A	±3%	120mV	90.0%
RPS-300-24 <input type="checkbox"/>	24V, 8.33A / 12.5A	±2%	150mV	92.5%
RPS-300-27 <input type="checkbox"/>	27V, 7.4A / 11.12A	±2%	200mV	93.0%
RPS-300-48 <input type="checkbox"/>	48V, 4.17A / 6.25A	±2%	250mV	93.0%

400W—Class I or II RPS-400

Model No.	Output (Convection/25CFM)	Tol.	R&N	Effi.
RPS-400-12 <input type="checkbox"/>	12V, 20.8A / 33.3A	±3%	120mV	91.5%
RPS-400-15 <input type="checkbox"/>	15V, 16.7A / 26.7A	±3%	120mV	92%
RPS-400-18 <input type="checkbox"/>	18V, 13.9A / 22.3A	±3%	150mV	93%
RPS-400-24 <input type="checkbox"/>	24V, 10.5A / 16.7A	±2%	150mV	93%
RPS-400-27 <input type="checkbox"/>	27V, 9.3A / 14.9A	±1%	200mV	93.5%
RPS-400-36 <input type="checkbox"/>	36V, 7A / 11.2A	±1%	200mV	94%
RPS-400-48 <input type="checkbox"/>	48V, 5.3A / 8.4A	±1%	200mV	94%

= blank, -C, -TF, -SF:
blank: PCB type, -C: Enclosed type, -TF: Enclosed type with fan on the top,
-SF: Enclosed type with fan on the side

500W Single Output

- 5"x3" compact size
- 320W convection, 500W force air, 550W peak
- Built-in active PFC function
- Medical safety approved (2xMOPP)
- Suitable for BF application with appropriate system consideration
- Class I or Class II configuration
- Protections: Short circuit / Overload / Over voltage / Over temperature
- Extremely low leakage current
- P.G, P.F signal output and remote sense function
- No load power consumption <0.5W by PS-ON control
- 12V/0.5A fan supply
- Standby 5V@1A
- LED indicator for power on
- 3 years warranty



RPS-500
127x 76.2x 41 mm(5"x3")



RPS-500-x-C
130x 86x 43 mm



RPS-500-x-TF
130x 86x 66.5 mm



RPS-500-x-SF
160x 86x 43 mm

AC input voltage range 80~264VAC
 Leakage current <220μA
 Withstand voltage I/P-O/P: 4kVAC, I/P-FG: 2kVAC, O/P-FG: 1.5kVAC
 Working temperature -30~+70°C (refer to output derating curve)
 Safety standards ANSI/AAMI ES60601-1, TUV BS EN/EN60601-1, IEC60601-1, EAC TP TC 004 approved
 EMC standards BS EN/EN55011, EN61000-3-2, 3, EN61204-3, EN61000-4,2,3,4,5,6,8,11, EN60601-1-2, EAC TP TC 020

Model No.	Output (Convection/25CFM)	Tol.	R&N	Effi.
RPS-500-12□	12V, 26.7A / 41.6A	±3%	200mV	91%
RPS-500-15□	15V, 21.3A / 33.3A	±3%	200mV	92%
RPS-500-18□	18V, 17.8A / 27.8A	±3%	200mV	92.5%
RPS-500-24□	24V, 13.4A / 20.8A	±2%	200mV	93%
RPS-500-27□	27V, 11.9A / 18.5A	±2%	200mV	93.5%
RPS-500-36□	36V, 8.9A / 13.9A	±1%	200mV	94%
RPS-500-48□	48V, 6.7A / 10.4A	±1%	200mV	94%

□ = blank, -C, -TF, -SF:
 blank: PCB type, -C: Enclosed type, -TF: Enclosed type with fan on the top, -SF: Enclosed type with fan on the side

200W Quad Output

- Universal AC input / Full range
- Built-in active PFC function
- Medical safety approved (2xMOPP)
- Suitable for BF application with appropriate system consideration
- Extremely low leakage current
- Protections: Short circuit / Overload / Over voltage / Over temperature
- Built-in remote sense function and remote ON/OFF control
- Free air convection for 140W, 200W with 25CFM forced air
- With P.G and P.F signal output
- 3 years warranty



MPQ-200
177.8x 107.2x 35.5 mm
(7"x 4.2")

AC input voltage range 90~264VAC
 AC inrush current Cold start, 60A at 230VAC
 Overload protection 120%~160% Hiccup mode, auto-recovery
 Over voltage protection CH1: 115%~135% rated output voltage, Shut down o/p voltage
 Leakage current <180μA
 Withstand voltage I/P-O/P: 4kVAC, I/P-FG:1.5kVAC, O/P-FG: 1.5kVAC
 Working temperature -20~+70°C (refer to output derating curve)
 Safety standards ANSI/AAMI ES60601-1, TUV BS EN/EN60601-1, IEC60601-1, EAC TP TC 004 approved; Design refer to UL62368-1,
 EMC standards BS EN/EN55011/EN55032 class B, EN61000-3-2,3, EN61000-4-2,3,4,5,6,8,11, EN60601-1-2, EN61000-6-2
 Connection 3P, 20P / 3.96mm pitch, JST B3P/VH, Molex 5566-20; 3P, 8Px2 / 3.96mm pitch. JSTB3P / B8Px2-VH

Model No.	Output	Tol.	R&N	Effi.	Max.
MPQ-200B	5V, 3.0~18A	±2%	80mV	78%	193W
	12V, 0.7~8.4A	±8%	120mV		
	-5V, 0.0~2.4A	±5%	80mV		
	-12V, 0.0~2.4A	±5%	80mV		
MPQ-200C	5V, 3.0~18A	±2%	80mV	78%	190W
	15V, 0.5~6.0A	±6%	150mV		
	-5V, 0.0~2.4A	±5%	80mV		
MPQ-200D	5V, 3.0~18A	±2%	80mV	79%	195W
	24V, 0.3~3.6A	±8%	180mV		
	12V, 0.0~2.4A	±5%	80mV		
MPQ-200F	5V, 3.0~18A	±2%	80mV	81%	200W
	24V, 0.3~3.3A	±8%	180mV		
	15V, 0.0~2.4A	±5%	80mV		
	-15V, 0.0~2.4A	±5%	80mV		

Industrial Adaptor 18~36W Desktop & Wall-mounted Type



Features

- Global certificates
- Universal AC input / Full range
- No load power consumption <0.075W
- Energy efficiency Level VI
- Comply with EISA 2007 / DoE, NRCAN, AU/NZ MEPS, Korea K-MEPS, EU ErP and CoC Version 5
- -30~+70°C wide range working temperature
- High reliable
- Protections: Short circuit / Overload / Over voltage
- Fully enclosed plastic case
- LED indicator for power on
- Pass LPS
- 3 years warranty



General Specification (Please refer to www.meanwell.com for detail spec.)



Order No.	GST18 <input type="checkbox"/>	GST25 <input type="checkbox"/>	GST36 <input type="checkbox"/>
AC input voltage range	85~264VAC		
AC inrush current (max.)	Cold start, 70A at 230VAC		
Overload protection	Range	110%~150% rated output power	110%~250% rated output power
	Type	Hiccup mode, auto-recovery	
Over voltage protection	110%~140% rated output voltage, clamp by zener diode		
Withstand voltage	I/P-O/P: 4242VDC, 1 minute		
Working temperature	-30~+70°C (refer to output derating curve)		
Safety standards	A-Type: UL62368-1, CSA 22.2, TUV BS EN/EN62368-1, BSMI CNS14336, CCC GB4943, PSE J62368-1, AS/NZS62368.1, KC K60950-1, BIS IS13252, EAC TP TC004; SIRIM MS IEC62368-1(optional) approved B-Type: "Same as A-Type" U-Type: UL62368-1, CSA22.2, BSMI CNS14336, EAC TP TC004 approved E-Type: TUV BS EN/EN62368-1, EAC TP TC004 approved		
EMC standards	BS EN/EN55032 class B, EN61000-3-2,3, EN61000-4-2,3,4,5,6,8,11(A/B/E type); FCC part 15 class B, CNS13438 class B(A/B/U type); GB9254(A/B type)		
Length of output cable	120cm of UL1185, 16AWG for 5~12V ; 180cm of UL1185, 18AWG for 15~48V	100cm of UL2468, 16AWG for 5~12V; 180cm of UL1185, 18AWG for 15~48V	100cm of UL2468, 16AWG
Standard DC plug (refer to page 73 for DC plug list)	P1J: 2.1x5.5x11mm / C+, tuning fork type		

Desktop / Wall-mounted — 18W

Order No.	Output	Tol.	R&N	Effi.	Order No.	Output	Tol.	R&N	Effi.
GST18□05-P1J	5V, 0~3.00A	±5%	80mV	81.0%	GST18□24-P1J	24V, 0~0.75A	±2%	150mV	88.0%
GST18□07-P1J	7.5V, 0~2.00A	±5%	80mV	85.0%	GST18□28-P1J	28V, 0~0.64A	±2%	150mV	88.5%
GST18□09-P1J	9V, 0~2.00A	±5%	80mV	85.0%	GST18□48-P1J	48V, 0~0.375A	±2%	150mV	89.0%
GST18□12-P1J	12V, 0~1.50A	±3%	80mV	86.0%	□ = A / B / U / E Class I — A: IEC320-C14 Class II — B: IEC320-C8, U: American 2P, E: European 2P				
GST18□15-P1J	15V, 0~1.20A	±3%	100mV	87.0%					
GST18□18-P1J	18V, 0~1.00A	±3%	150mV	88.0%					

Desktop / Wall-mounted — 25W

Order No.	Output	Tol.	R&N	Effi.	Order No.	Output	Tol.	R&N	Effi.
GST25□05-P1J	5V, 0~4.00A	±5%	80mV	81.5%	GST25□24-P1J	24V, 0~1.04A	±2%	150mV	88.0%
GST25□07-P1J	7.5V, 0~2.93A	±5%	80mV	84.5%	GST25□28-P1J	28V, 0~0.89A	±2%	150mV	88.0%
GST25□09-P1J	9V, 0~2.55A	±5%	80mV	85.0%	GST25□48-P1J	48V, 0~0.52A	±2%	150mV	89.0%
GST25□12-P1J	12V, 0~2.08A	±3%	80mV	86.5%	□ = A / B / U / E Class I — A: IEC320-C14 Class II — B: IEC320-C8, U: American 2P, E: European 2P				
GST25□15-P1J	15V, 0~1.66A	±3%	100mV	87.0%					
GST25□18-P1J	18V, 0~1.38A	±3%	100mV	87.0%					

Wall-mounted — 36W

Order No.	Output	Tol.	R&N	Effi.	Order No.	Output	Tol.	R&N	Effi.
GST36□05-P1J	5V, 0~4.30A	±5%	90mV	82.0%	GST36□24-P1J	24V, 0~1.50A	±2%	150mV	88.5%
GST36□09-P1J	9V, 0~3.11A	±5%	90mV	86.0%	GST36□48-P1J	48V, 0~0.75A	±2%	200mV	90.0%
GST36□12-P1J	12V, 0~3.00A	±3%	100mV	87.5%	□ = B / U / E ; B: IEC320-C8; U: American 2P, E: European 2P				



Features

- Global certificates
- Universal AC input / Full range
- No load power consumption <math><0.075\sim0.15W</math> by models
- Energy efficiency Level VI
- Comply with EISA 2007 / DoE, NRCAN, AU/NZ MEPS, Korea K-MEPS, EU ErP and CoC Version 5
- $-30\sim+70^{\circ}\text{C}$ wide range working temperature
- High reliable
- Class I power (with earth pin)
- Protections: Short circuit / Over voltage / Overload / Over temp. (except for GST40A)
- Fully enclosed plastic case
- LED indicator for power on
- Pass LPS (except for GST90A/120A)
- 3 years warranty

GST40/60A
125x 50x 31.5 mm

GST90A
145x 60x 32 mm

GST120A
167x 67x 35 mm

General Specification



Order No.	GST40A	GST60A	GST90A	GST120A
AC input voltage range	90~264VAC; 127~370VDC			85~264VAC; 120~370VDC
AC inrush current (max.)	Cold start, 65A at 230VAC		Cold start, 70A at 230VAC	
Overload protection	Range	105%~150% rated output power	110%~150%	105%~160%
	Type	Hiccup mode, auto-recovery		
Over voltage protection	105%~135% rated output voltage			
Setup, rise, hold up time	1000ms, 50ms, 50ms		1000ms, 50ms, 20ms	
Withstand voltage	I/P-O/P:3kVAC, I/P-FG: 2kVAC, O/P-FG: 0.5kVAC			I/P-FG: 3kVAC
Working temperature	$-30\sim+70^{\circ}\text{C}$ (refer to output derating curve)			
Safety standards	UL62368-1, CSA 22.2, TUV BS EN/EN62368-1, BSMI CNS14336, CCC GB4943, PSE J62368-1, AS/NZS62368.1, KC K60950-1, BIS IS13252, EAC TP TC004; SIRIM MS IEC60950-1(optional) approved			
EMC standards	BS EN/EN55032 class B, EN61000-3-2,3, EN61000-4-2,3,4,5,6,8,11, CNS13438, GB9254, FCC part15 class B, EAC TP TC 020			
Length of output cable	GST40A: 100cm of UL1185, 16AWG for 5~15V; 180cm of UL1185, 18AWG for 18~48V GST60A: 100cm of UL2464, 16AWG for 5~9V; 100cm of UL1185, 16AWG for 12~15V; 150cm of UL1185, 16AWG for 18V; 180cm of UL1185, 18AWG for 24~48V		100cm of UL1185, 14AWG for 12~15V; 120cm of UL1185, 16AWG for 19~48V	
Standard DC plug (refer to page 73 for DC plug list)	P1J: 2.1øx5.5øx11mm / C+, tuning fork type		P1M: 2.5øx5.5øx11mm / C+, tuning fork type	
	R7B: Power DIN 4P with lock type P1M: 2.5øx5.5øx11mm/C+, tuning fork type (20~48V only)			

Desktop (IEC 320-C14 / Class I) — 40W

Order No.	Output	Tol.	R&N	Effi.
GST40A05-P1J	5V, 0~5.00A	±5%	120mV	84.5%
GST40A07-P1J	7.5V, 0~5.34A	±5%	120mV	87.5%
GST40A09-P1J	9V, 0~4.45A	±5%	120mV	88.5%
GST40A12-P1J	12V, 0~3.34A	±3%	120mV	89.5%
GST40A15-P1J	15V, 0~2.67A	±3%	120mV	90.0%
GST40A18-P1J	18V, 0~2.22A	±3%	120mV	90.0%
GST40A24-P1J	24V, 0~1.67A	±2.5%	150mV	91.0%
GST40A48-P1J	48V, 0~0.84A	±2.5%	200mV	92.0%

Desktop (IEC 320-C14 / Class I) — 60W

Order No.	Output	Tol.	R&N	Effi.
GST60A05-P1J	5V, 0~6.00A	±5%	120mV	85.5%
GST60A07-P1J	7.5V, 0~6.00A	±5%	120mV	88.5%
GST60A09-P1J	9V, 0~6.00A	±5%	120mV	89.0%
GST60A12-P1J	12V, 0~5.00A	±3%	120mV	89.5%
GST60A15-P1J	15V, 0~4.00A	±3%	120mV	89.5%
GST60A18-P1J	18V, 0~3.33A	±3%	150mV	89.5%
GST60A24-P1J	24V, 0~2.50A	±3%	150mV	90.5%
GST60A48-P1J	48V, 0~1.25A	±2.5%	200mV	92.0%

Desktop (IEC 320-C14 / Class I) — 90W

Order No.	Output	Tol.	R&N	Effi.
GST90A12-P1M	12V, 0~6.67A	±5%	120mV	89.0%
GST90A15-P1M	15V, 0~6.00A	±5%	150mV	89.5%
GST90A19-P1M	19V, 0~4.74A	±4%	180mV	90.0%
GST90A24-P1M	24V, 0~3.75A	±3%	200mV	90.0%
GST90A48-P1M	48V, 0~1.87A	±2.5%	200mV	91.0%

Desktop (IEC 320-C14 / Class I) — 120W

Order No.	Output	Tol.	R&N	Effi.
GST120A12-R7B	12V, 0~8.5A	±5%	120mV	88.5%
GST120A15-R7B	15V, 0~7.0A	±5%	120mV	89.0%
GST120A20-□	20V, 0~6.0A	±5%	150mV	90.0%
GST120A24-□	24V, 0~5.0A	±3%	180mV	90.5%
GST120A48-□	48V, 0~2.5A	±2.5%	200mV	91.0%

□ = P1M / R7B

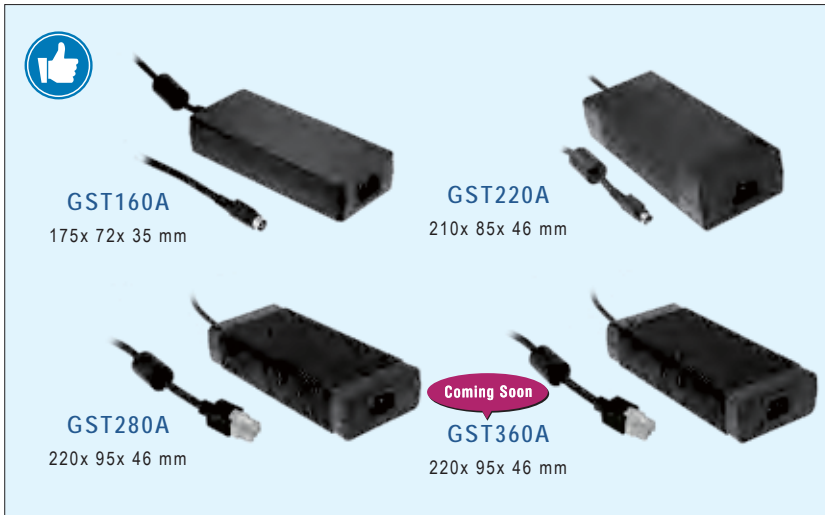

Features

- Global certificates
- No load power consumption <math><0.15W</math> (GST280A/360A <math><0.5W</math>)
- Energy efficiency Level VI
- Comply with EISA 2007 / DoE, NRCAN, AU/NZ MEPS, Korea K-MEPS, EU ErP and CoC Version 5
- 3 pole AC inlet IEC320-C14
- Class I power (with earth pin)
- Fanless design, high operating temperature up to +70°C
- Protections: Short circuit / Overload / Over voltage / Over temperature
- Fully enclosed plastic case
- LED indicator for power on
- Comply with EN60335-1 (GST360)
- 450W Peak power (GST360)
- 3 years warranty

General Specification



Order No.	GST160A	GST220	GST280A	GST360A
AC input voltage range	85~264VAC ; 120~370VDC			
Overload protection	Range	105%~135% rated output power		
	Type	Hiccup mode, auto-recovery		
Over voltage protection	Range	105%~150% rated output power	105%~135% rated output power	
	Type	Shut down o/p voltage, re-power on to recover		
Set up, rise, hold up time	2000ms, 50ms, 20ms		2000ms, 20ms, 16ms	2000ms, 20ms, 8ms
Withstand voltage	I/P-O/P: 3kVAC, 1 minute			
Working temperature	-30~+70°C (refer to output derating curve)			
Safety standards	UL62368-1, CSA 22.2, TUV BS EN/EN62368-1, BSMI CNS14336, CCC GB4943, PSE J62368-1, AS/NZS62368.1, KC K60950-1, BIS IS13252, EAC TP TC004; SIRIM MS IEC60950-1 (optional) approved; EN60335-1 approved for GST360			
EMC standards	BS EN/EN55032 class B, EN61000-3-2,3, EN61000-4-2,3,4,5,6,8,11, FCC part 15 class B, CNS13438, GB9254, GB17625.1, EAC TP TC 020			
Length of output cable	100cm of UL2464, 18AWGx4C for 12V 120cm of UL2464, 18AWGx4C for 15~48V	100cm of UL2464, 16AWGx4C		
Standard DC plug (refer to page 73 for DC plug list)	R7B: Power DIN 4P with lock type		6P/4.2mm pitch, MOLEX 39-01-2060 (power supply side); MOLEX 39-01-2061 (customer side, not provided with GST280A); 8P/4.2mm pitch (GST360A12-C8P), MOLEX 39-01-2080	

Desktop (IEC320-C14/Class I) — 160W

Order No.	Output	Tol.	R&N	Effi.
GST160A12-R7B	12V, 0~11.5A	±5%	80mV	90.0%
GST160A15-R7B	15V, 0~9.6A	±5%	100mV	91.0%
GST160A20-R7B	20V, 0~8.0A	±4%	120mV	93.0%
GST160A24-R7B	24V, 0~6.67A	±3%	150mV	93.0%
GST160A36-R7B	36V, 0~4.44A	±3%	150mV	92.0%
GST160A48-R7B	48V, 0~3.34A	±3%	200mV	94.0%

Desktop (IEC320-C14/Class I) — 280W

Order No.	Output	Tol.	R&N	Effi.
GST280A12-C6P	12V, 0~21A	±5%	120mV	89.5%
GST280A15-C6P	15V, 0~17A	±5%	120mV	90.0%
GST280A20-C6P	20V, 0~13A	±4%	150mV	92.0%
GST280A24-C6P	24V, 0~11.67A	±3%	200mV	93.0%
GST280A48-C6P	48V, 0~5.84A	±2%	200mV	94.0%

Desktop (IEC320-C14/Class I) — 220W

Order No.	Output	Tol.	R&N	Effi.
GST220A12-R7B	12V, 0~15.0A	±5%	80mV	90.0%
GST220A15-R7B	15V, 0~13.4A	±5%	100mV	90.0%
GST220A20-R7B	20V, 0~11.0A	±4%	120mV	92.0%
GST220A24-R7B	24V, 0~9.20A	±3%	150mV	93.5%
GST220A36-R7B	36V, 0~6.10A	±3%	200mV	93.0%
GST220A48-R7B	48V, 0~4.60A	±2%	200mV	94.5%

Desktop (IEC320-C14/Class I) — 360W

Order No.	Output	Tol.	R&N	Effi.
GST360A12-C8P	12V, 0~27.5A	±5%	120mV	91.0%
GST360A15-C6P	15V, 0~22.7A	±5%	120mV	92.0%
GST360A24-C6P	24V, 0~15A	±3%	200mV	93.0%
GST360A36-C6P	36V, 0~10A	±2%	200mV	94.0%
GST360A48-C6P	48V, 0~7.5A	±2%	200mV	95.0%
GST360A55-C6P	55V, 0~6.55A	±2%	200mV	95.5%

5W Green USB Adaptor



- Universal AC input / Full range
- No load power consumption <0.075W
- Energy efficiency Level VI
- Comply with EISA 2007/DoE and EU ErP
- Compact size
- 2 pole US / European type plug
- Class II power (without earth pin)
- Protections: Short circuit / Overload / Over voltage / Over temp.
- Pass LPS
- Fully enclosed plastic case
- 2 years warranty

AC input voltage range ... 90~264VAC ; 127~370VDC
 Overload protection 105%~135% rated output power, hiccup mode, auto-recovery
 Over voltage protection ... 105%~200% rated output voltage, hiccup mode, auto-recovery
 Withstand voltage I/P-O/P: 4242VDC, 1 minute
 Working temperature -20~+50°C (refer to output derating curve)
 Safety standards U-Type: UL62368-1, CSA22.2, EAC TP TC 004 approved
 E-Type: TUV BS EN/EN62368-1, EAC TP TC 004 approved
 EMC standards FCC part15 class B(U Type); BS EN/EN55032 class B(E Type)
 Standard DC plug..... USB Type A

Order No.	Output	Tol.	R&N	Effi.
GS05U-USB	5V, 0~1A	±5%	90mV	74.0%
GS05E-USB	5V, 0~1A	±4%	80mV	74.5%

6W Green Adaptor

- Universal AC input / Full range
- No load power consumption < 0.1W
- Energy efficiency Level VI
- Comply with EISA 2007/DoE and EU ErP
- 2 pole US / European type plug
- Class II power (without earth pin)
- Protections: Short circuit / Overload / Over voltage
- Pass LPS
- Fully enclosed plastic case
- 2 years warranty



AC input voltage range 90~264VAC ; 127~370VDC
 AC inrush current(max.) .. Cold start, 50A at 230VAC
 Overload protection Hiccup mode, auto-recovery
 Over voltage protection ... Clamp by zener diode >120%
 Withstand voltage I/P-O/P: 4242VDC, 1minute
 Working temperature 0~+50°C (refer to output derating curve)
 Safety standards UL62368-1, CSA 22.2, TUV BS EN/EN62368-1, EAC TP TC 004
 EMC standards FCC part15 class B(U Type); EN55032 class B(E Type)
 Length of output cable 120cm of 18AWG for 5~9V; 180cm of 24AWG for 12~48V

Order No.	Output	Tol.	R&N	Effi.
GS06□-1P1J	5V, 0~1.00A	±5%	50mV	68.0%
GS06□-11P1J	7.5V, 0~0.80A	±5%	80mV	80.0%
GS06□-2P1J	9V, 0~0.66A	±5%	80mV	75.0%
GS06□-3P1J	12V, 0~0.50A	±3%	100mV	77.0%
GS06□-4P1J	15V, 0~0.40A	±3%	120mV	79.5%
GS06□-5P1J	18V, 0~0.33A	±3%	150mV	81.0%
GS06□-6P1J	24V, 0~0.25A	±2%	180mV	81.0%
GS06□-8P1J	48V, 0~0.125A	±2%	200mV	83.0%

□ = U/E ; U: American 2P, E: European 2P

15W Green Adaptor

- Universal AC input / Full range
- No load power consumption <0.075W
- Energy efficiency Level VI
- Comply with EISA 2007/DoE and EU ErP
- Protections: Short circuit / Overload / Over voltage
- Pass LPS
- Fully enclosed plastic case
- 2 years warranty



GS15 vs. SGAS15

Difference Series		Dimension (LxWxH,mm)	Working Temp.	Warranty
GS15	A	100x58.5x32.8	0~50	2 years
	B			
	E	71x34x50		
	U			
SGAS15	A	85.7x50.9x33.8(-23%)	-20~+70	3 years
	B	80x39x27.7(-55%)		
	E	87.6x42.1x24.7(-50%)		
	U	*Take up one stop on power strip		

Order No.	Output	Tol.	R&N	Effi.
GS15□-1P1J	5.0V, 0~2.40A	±5%	50mV	80.0%
GS15□-11P1J	7.5V, 0~1.60A	±5%	80mV	82.5%
GS15□-2P1J	9.0V, 0~1.66A	±5%	80mV	85.0%
GS15□-3P1J	12V, 0~1.25A	±3%	80mV	85.0%
GS15□-4P1J	15V, 0~1.00A	±3%	100mV	85.0%
GS15□-5P1J	18V, 0~0.83A	±3%	120mV	85.0%
GS15□-6P1J	24V, 0~0.625A	±2%	150mV	85.5%
GS15□-8P1J	48V, 0~0.31A	±2%	240mV	87.0%

□ = A/B/E/U ; A:IEC320-C14, B: IEC320-C8
 E: European 2P, U: American 2P

※ The size and performance of SGAS15A/B/E/U are better than GS15A/B/E/U. It is highly recommended to use SGAS15A/B/E/U for all new project

Industrial Adaptor 6~60W Extreme Small Desktop & Wall-mounted



Features

- **Extreme small** and space-saving
- **Takes up one spot on power strip**(U/E Type)
- Universal AC input/Full range
- No low power consumption<0.075~0.1W by models
- Energy efficiency Level **VI**
- Comply with EISA 2007/DoE,EU ErP and meet CoC Version5
- **-20~+70** wide range working temperature
- Protections: short circuit/over load/Over voltage
- Pass **LPS**
- 3 years warranty

General Specification (Please refer to www.meanwell.com for detail spec.)



Order No.	SGAS06□	SGAS15□	SGAS60□
AC input voltage range	90~264VAC; 127~370VDC		
Overload protection	Hiccup mode, recovers automatically after fault condition is removed		
Over voltage protection	Clamp by Zene diode		
Withstand voltage	I/P-O/P: 4242VDC	I/P-O/P: 3KVAC	I/P-O/P: 4242VDC
Working temperature	-20~+70°C (refer to output derating curve)		
Safety standards	A/B Type:CB/TUV/UL 62368-1,EAC TPTC004 approved E Type:CB/TUV EN62368-1,EAC TP TC 004 approved U Type:CB/UL 62368-1 approved		
EMC standards	E Type:BS EN/EN55032 class B, EN61000-3-2,3, EN61000-4-2,3,4,5,6,8,11; U Type:FCC part15 classB		
Length of output cable	120cm, 20AWG for 5~9V; 180cm, 24AWG for 12~48V	120cm, 20AWG for 5~12V; 120cm, 24AWG for 15V; 180cm, 24AWG for 24V	100cm, 16AWG for 5~15V; 150cm, 18AWG for 24~48V;
Standard DC plug (refer to page 73 for DC plug list)	P1J: 2.1øx5.5øx11mm / C+, tuning fork type		

Wall-mounted— 6W

Model No.	Output	Tol.	R&N	Effi.	Order No.	Output	Tol.	R&N	Effi.
SGAS06□05-P1J	5V, 0~1.00A	±5%	75mV	75%	SGAS06□15-P1J	15V, 0~0.4A	±3%	80mV	81%
SGAS06□07-P1J	7.5V, 0~0.8A	±5%	85mV	77%	SGAS06□24-P1J	24V, 0~0.25A	±3%	80mV	83%
SGAS06□09-P1J	9V, 0~0.66A	±5%	80mV	80%	SGAS06□48-P1J	48V, 0~0.125A	±2%	80mV	84%
SGAS06□12-P1J	12V, 0~0.5A	±3%	80mV	80%					

□ = U / E
Class II — U: American 2P, E: European 2P

Desktop/Wall-mounted— 15W

Model No.	Output	Tol.	R&N	Effi.	Order No.	Output	Tol.	R&N	Effi.
SGAS15□05-P1J	5V, 0~2.40A	±5%	80mV	79%	SGAS15□24-P1J	24V, 0~0.625A	±2%	100mV	86%
SGAS15□09-P1J	9V, 0~1.66A	±5%	80mV	84%					
SGAS15□12-P1J	12V, 0~1.25A	±3%	80mV	85%					
SGAS15□15-P1J	15V, 0~1.00A	±3%	80mV	85%					

□ = A / B / U / E
Class I — A: IEC320-C14
Class II — B: IEC320-C8, U: American 2P, E: European 2P

Wall-mounted— 60W

Model No.	Output	Tol.	R&N	Effi.	Order No.	Output	Tol.	R&N	Effi.
SGAS60□05-P1J	5V, 0~6A	±5%	80mV	85%	SGAS60□24-P1J	24V, 0~2.5A	±2%	100mV	89%
SGAS60□12-P1J	12V, 0~5A	±3%	80mV	88%	SGAS60□48-P1J	48V, 0~1.25A	±2%	120mV	90%
SGAS60□15-P1J	15V, 0~4A	±3%	80mV	88%					

□ = U / E ; U: American 2P, E: European 2P



Features

- Universal AC input / Full range
- No load power consumption <0.075W
- Energy efficiency level VI
- Comply with EISA 2007/DoE, EU ErP
- 2 pole US/European type plug
- Class II power (without earth pin)
- Protections: Short circuit / Over load / Over voltage

- Pass LPS
- Fully enclosed plastic case
- 3 years warranty

※ The size and performance of SGA15E/U are better than SGA18U/E. It is highly recommended to use SGA15E/U for all new project

General Specification (Please refer to www.meanwell.com for detail spec.)



Model No.	SGA12□	SGA18□	SGA25□
AC input voltage range	90~264VAC; 127~370VDC		
DC adjustment range	±10% rated output voltage		
Overload protection	Hiccup mode, auto recovery		
Over voltage protection	Clamp by Zener diode		
Setup, rise, hold up time	1300ms, 50ms, 12ms	300ms, 30ms, 16ms	300ms, 60ms, 18ms
Withstand voltage	I/P-O/P: 4242VDC		
Working temperature	-20~+60°C (refer to output derating curve)		
Safety standards	U-Type: UL62368-1, CSA22.2, EAC TP TC 004 approved; E-Type: TUV BS EN/EN62368-1, EAC TP TC 004 approved		
EMC standards	U-Type: FCC part15 class B; E-Type: BS EN/EN55032 class B, EN61000-4-2,3,4,5,6,8,11, EN61000-3-2,3		
Length of output cable	100cm of 20AWG for SGA12□05~07-P1J 120cm of 22AWG for SGA12□09-P1J 180cm of 24AWG for SGA12□12~48-P1J	100cm of 20AWG for 5~12V 150cm of 24AWG for 15~48V	100cm of 18AWG for 5~7.5V 100cm of 20AWG for 9~12V 180cm of 20AWG for 15~18V 180cm of 24AWG for 24~48V
Standard DC Plug (refer to page 73 for DC plug list)	USB: Type A; P1J: 2.1øx5.5øx11mm / C+, tuning fork type		

Wall-mounted – 12W

Model No.	Output	Tol.	R&N	Effi.
SGA12□05-USB	5V, 2.40A	±5%	50mV	80.0%
SGA12□05-P1J	5V, 2.40A	±5%	50mV	80.0%
SGA12□07-P1J	7.5V, 1.60A	±5%	50mV	83.0%
SGA12□09-P1J	9V, 1.33A	±3%	80mV	82.5%
SGA12□12-P1J	12V, 1.00A	±3%	80mV	83.0%
SGA12□15-P1J	15V, 0.80A	±3%	80mV	83.0%
SGA12□18-P1J	18V, 0.666A	±3%	80mV	83.5%
SGA12□24-P1J	24V, 0.50A	±2%	100mV	84.0%
SGA12□48-P1J	48V, 0.25A	±2%	100mV	86.0%

□ = U/E; U: American 2P, E: European 2P

Model No.	Output	Tol.	R&N	Effi.
SGA18□15-P1J	15V, 1.20A	±3%	80mV	85.5%
SGA18□18-P1J	18V, 1.00A	±3%	80mV	86.0%
SGA18□24-P1J	24V, 0.75A	±2%	100mV	86.5%
SGA18□48-P1J	48V, 0.375A	±2%	120mV	87.5%

□ = U/E; U: American 2P, E: European 2P

Wall-mounted – 18W



Model No.	Output	Tol.	R&N	Effi.
SGA18□05-P1J	5V, 3.00A	±5%	80mV	81.5%
SGA18□09-P1J	9V, 2.00A	±5%	80mV	84.0%
SGA18□12-P1J	12V, 1.50A	±3%	80mV	85.5%

Wall-mounted – 25W

Model No.	Output	Tol.	R&N	Effi.
SGA25□05-P1J	5V, 4.00A	±5%	80mV	81.0%
SGA25□07-P1J	7.5V, 2.93A	±5%	80mV	85.0%
SGA25□09-P1J	9V, 2.77A	±5%	80mV	85.5%
SGA25□12-P1J	12V, 2.08A	±3%	80mV	86.0%
SGA25□15-P1J	15V, 1.66A	±3%	80mV	86.5%
SGA25□18-P1J	18V, 1.38A	±3%	80mV	86.5%
SGA25□24-P1J	24V, 1.04A	±2%	80mV	87.0%
SGA25□48-P1J	48V, 0.52A	±2%	120mV	88.5%

□ = U/E; U: American 2P, E: European 2P



Features

- Slim Type
- Universal AC input / Full range
- No load power consumption <math><0.075W \sim 0.15W</math> by models for SGA40 and SGA60 5~7.5V;
- Energy efficiency Level VI
- Comply with EISA 2007/DoE, EU ErP
- 2 pole US/European type plug
- Class II power (without earth pin)
- Protections: Short circuit / Overload / Over voltage
- Pass LPS
- Fully enclosed plastic case
- LED indicator for power on (60W only)
- 3 years warranty

General Specification



Model No.	SGA40□	SGA60□
AC input voltage range	90~264VAC; 127~370VDC	
Overload protection	Hiccup mode, auto recovery	
Over voltage protection	110%~140% rated output voltage, clamp by Zener diode	
Setup, rise, hold up time	500ms, 100ms, 12ms	500ms, 50ms, 12ms
Withstand voltage	I/P-O/P:4242VDC, 1 minute	
Working temperature	-20~+50°C (refer to output derating curve)	
Safety standards	U-Type: UL62368-1, CSA 22.2, EAC TP TC004 approved; E-Type: TUV BS EN/EN62368-1, EAC TP TC 004 approved	
EMC standards	U-Type: FCC part15 Class B; E-Type: BS EN/EN55032 Class B	
Length of output cable	100cm of 18AWG for 5V~15V 150cm of 20AWG for 18~48V	100cm of 16AWG for 5~18V 150cm of 18AWG for 24~48V
Standard DC Plug (refer to page 73 for DC plug list)	P1J: 2.1øx5.5øx11mm/C+, turning fork type	

Wall-mounted — 40W

Model No.	Output	Tol.	R&N	Effi.
SGA40□05-P1J	5V, 0~5.00A	±5%	120mV	83.0%
SGA40□09-P1J	9V, 0~4.44A	±5%	120mV	86.5%
SGA40□12-P1J	12V, 0~3.33A	±3%	120mV	86.5%
SGA40□15-P1J	15V, 0~2.66A	±2%	120mV	86.5%
SGA40□18-P1J	18V, 0~2.22A	±2%	120mV	87.0%
SGA40□24-P1J	24V, 0~1.67A	±2%	150mV	88.0%
SGA40□48-P1J	48V, 0~0.84A	±2%	150mV	89.0%

□ = U / E, U: American 2P, E: European 2P

Wall-mounted — 60W

Model No.	Output	Tol.	R&N	Effi.
SGA60□05-P1J	5V, 0~6.00A	±5%	80mV	83.5%
SGA60□07-P1J	7.5V, 0~6.00A	±5%	80mV	85.0%
SGA60□09-P1J	9V, 0~5.50A	±5%	80mV	86.5%
SGA60□12-P1J	12V, 0~5.00A	±3%	80mV	87.5%
SGA60□15-P1J	15V, 0~4.00A	±3%	80mV	87.0%
SGA60□18-P1J	18V, 0~3.33A	±2%	80mV	88.0%
SGA60□24-P1J	24V, 0~2.50A	±2%	100mV	88.0%
SGA60□48-P1J	48V, 0~1.25A	±2%	120mV	89.5%

□ = U / E, U: American 2P, E: European 2P

Industrial Adaptor 12~40W Interchangeable Type



■ Features

- Interchangeable AC plugs (plug kit sold separately)
- Universal AC input / Full range
- No load power consumption <0.075W
- Energy efficiency Level VI
- Comply with EISA 2007/DoE and EU ErP
- Class II power (without earth pin)
- Protections: Short circuit / Over voltage / Overload
- Fully enclosed plastic case
- LED indicator for power on
- Pass LPS
- 2 years warranty

■ General Specification (Please refer to www.meanwell.com for detail spec.)



Model No.	GE12	GE18	GE24	GE30	GE40
AC input voltage range	90~264VAC / 0.4A for GE12; 90~264VAC / 0.7A for GE18/24/30				
Withstand voltage	I/P-O/P:4242VDC, 1 minute				
Working temperature	-10~+50°C (refer to output derating curve)				-30~+70°C
Safety standards	UL62368-1, CSA22.2, TUV BS EN/EN62368-1, CCC GB4943, AS/NZS 62368.1, EAC TP TC 004 approved				
EMC standards	BS EN/EN55032 class B, EN61000-3-2,3, EN61000-4-2,3,4,5,6,8,11, FCC part15 class B, GB9254, GB17625.1				
Length of output cable	100cm for GE12 5~12V, GE18/24 5~12V, GE30 12V and GE40 5~12V 150cm for GE12/18 15~48V, GE24 15~48V, GE30 15~24V and GE40 15~48V				
Standard DC plug (refer to page 73 for DC plug list)	P1J: 2.1øx5.5øx11mm / C+, tuning fork type				

■ Wall-mounted (Interchangeable Type)—12W

Order No. (Main body)	Output	Tol.	R&N	Effi.
GE12105-P1J	5V, 0~2.00A	±5%	50mV	80.0%
GE12107-P1J	7.5V, 0~1.33A	±5%	75mV	82.0%
GE12109-P1J	9V, 0~1.33A	±5%	100mV	84.0%
GE12112-P1J	12V, 0~1.00A	±3%	120mV	84.0%
GE12115-P1J	15V, 0~0.80A	±3%	150mV	85.0%
GE12118-P1J	18V, 0~0.83A	±3%	180mV	85.0%
GE12124-P1J	24V, 0~0.625A	±3%	240mV	85.5%

Order No. (Main body)	Output	Tol.	R&N	Effi.
GE24112-P1J	12V, 0~2.00A	±3%	120mV	86.0%
GE24115-P1J	15V, 0~1.60A	±3%	150mV	86.0%
GE24118-P1J	18V, 0~1.33A	±3%	180mV	87.0%
GE24124-P1J	24V, 0~1.00A	±3%	240mV	87.5%
GE24148-P1J	48V, 0~0.50A	±3%	300mV	89.0%

■ Wall-mounted (Interchangeable Type)—30W

Order No. (Main body)	Output	Tol.	R&N	Effi.
GE30112-P1J	12V, 0~2.50A	±3%	120mV	84%
GE30115-P1J	15V, 0~2.00A	±3%	150mV	86%
GE30118-P1J	18V, 0~1.66A	±3%	180mV	87%
GE30124-P1J	24V, 0~1.25A	±3%	240mV	87%

■ Wall-mounted (Interchangeable Type)—18W

Order No. (Main body)	Output	Tol.	R&N	Effi.
GE18105-P1J	5V, 0~2.40A	±5%	50mV	80.5%
GE18107-P1J	7.5V, 0~1.73A	±5%	75mV	82.5%
GE18109-P1J	9V, 0~2.00A	±5%	100mV	85.0%
GE18112-P1J	12V, 0~1.50A	±3%	120mV	86.0%
GE18115-P1J	15V, 0~1.20A	±3%	150mV	86.5%
GE18118-P1J	18V, 0~1.00A	±3%	180mV	87.0%
GE18124-P1J	24V, 0~0.75A	±3%	240mV	87.0%
GE18148-P1J	48V, 0~0.375A	±3%	300mV	87.0%

■ Wall-mounted (Interchangeable Type)—40W

Order No. (Main body)	Output	Tol.	R&N	Effi.
GE40105-P1J	5V, 0~4.00A	±3%	100mV	81.0%
GE40107-P1J	7.5V, 0~2.66A	±3%	100mV	85.0%
GE40109-P1J	9V, 0~3.30A	±3%	100mV	86.0%
GE40112-P1J	12V, 0~3.30A	±3%	120mV	87.0%
GE40115-P1J	15V, 0~2.70A	±3%	150mV	87.0%
GE40118-P1J	18V, 0~2.20	±3%	180mV	88.0%
GE40124-P1J	24V, 0~1.67A	±3%	240mV	88.0%
GE40136-P1J	36V, 0~1.11A	±3%	300mV	89.0%
GE40148-P1J	48V, 0~0.83A	±3%	300mV	89.0%

■ Wall-mounted (Interchangeable Type)—24W

Order No. (Main body)	Output	Tol.	R&N	Effi.
GE24105-P1J	5V, 0~3.00A	±5%	50mV	81.0%
GE24107-P1J	7.5V, 0~2.00A	±5%	75mV	83.0%
GE24109-P1J	9V, 0~2.22A	±5%	100mV	85.5%

■ Interchangeable AC Plug Specifically for GE Series

AC Plug Type and Order No.					
AC Plug-AU3 (for GE40 only)	AC Plug-AU (for GE12~30)	AC Plug-UK (for GE12~40)	AC Plug-EU (for GE12~40)	AC Plug-US (for GE12~40)	AC Plug-MIX (for GE12~30) AC Plug-MIX3 (for GE40 only)
Australian Type	Australian Type	U.K. Type	European Type	U.S. Type	Mixed Four Type

Note: The main body unit and AC plug should be ordered separately. The main body needs to be used along with any one of the AC plug.

Industrial Adaptor

25~50W Triple Output Desktop Type



Features

- Universal AC input / Full range
- No load power consumption <0.3W
- Energy efficiency **Level VI**
- Protections:
Short circuit / Overload / Over voltage / Over temp. (GP25)
- Comply with EISA 2007/DoE, EU ErP
- Class I power unit (with earth pin) for A type;
Class II power unit (without earth pin) for B type
- Fully enclosed plastic case
- LED indicator for power on
- **Dual output available (optional)**
- 3 years warranty

General Specification (Please refer to www.meanwell.com for detail spec.)



Model No.	GP25A	GP25B	GP50A
AC input voltage range	90~264VAC ; 135~370VDC		
AC inrush current (max.)	Cold start, 60A at 230VAC		Cold start, 45A at 230VAC
Overload protection	Hiccup mode, auto recovery		
Over voltage protection	110%~140% of +5V output		
Setup, rise, hold up time	800ms, 50ms, 20ms		1000ms, 50ms, 20ms
Withstand voltage	I/P-O/P:3kVAC, I/P-FG:1.5kVAC , 1 minute		
Working temperature	-20~+70°C (refer to output derating curve)		
Safety standards	UL62368-1, CSA22.2, TUV BS EN/EN62368-1, EAC TP TC 004 approved		
EMC standards	BS EN/EN55032 class B, EN61000-3-2,3, EN61000-4-2,3,4,5,6,11, FCC part15 class B		
Length of output cable	150cm of UL2464		100cm of UL2464
Standard DC Plug (refer to page 73 for DC plug)	R1B: DIN 5P		
Dimension (LxWxH)(mm)	107.5x 67x 36		146x 75.5x 43

29W GP25A/B Series

Order No.	Output	Tol.	R&N	Effi.	Max.
GP25□13A-R1B	5V, 0.5~2.5A	±5%	50mV	80.0%	28.5W
	12V, 0.2~1.2A	-5%~+10%	100mV		
	-5V, 0.1~0.3A	±3%	50mV		
GP25□13D-R1B	5V, 0.5~2.5A	±5%	60mV	80.0%	28W
	12V, 0.2~1.0A	±5%	120mV		
	-12V, 0.1~0.3A	±3%	50mV		
GP25□14E-R1B	5V, 0.5~2.5A	±5%	100mV	80.5%	29W
	15V, 0.1~0.8A	-5%~+15%	150mV		
	-15V, 0.1~0.3A	±3%	50mV		

□ = A / B; A: IEC 320-C14 / Class I, B: IEC 320-C8 / Class II

50W GP50A Series

Order No.	Output	Tol.	R&N	Effi.	Max.
GP50A13A-R1B	5V, 0.0~4.0A	±5%	50mV	83.5%	46.5W
	12V, 0.3~2.0A	±3%	100mV		
	-5V, 0.1~0.5A	-5%~+10%	100mV		
GP50A13D-R1B	5V, 0.0~4.0A	±5%	50mV	84.0%	50W
	12V, 0.3~2.0A	±3%	150mV		
	-12V, 0.1~0.5A	-5%~+8%	100mV		
GP50A14E-R1B	5V, 0.0~4.0A	±5%	50mV	84.5%	50W
	15V, 0.3~1.5A	±3%	150mV		
	-15V, 0.1~0.5A	-5%~+15%	150mV		
GP50A58F (optional)	16V, 0.4~2A	±5%	180mV	86%	71.2W
	48V, 30~150mA	-5%~+10%	180mV		
	-16V, 0.4~2A	-5%~+10%	180mV		

Moistureproof Adaptor

60~90W IP67 Level



Features

- IP67 design for power body
- Universal AC input / Full range
AC input 180~264VAC only
- No load power consumption <0.15W
- Energy efficiency Level VI
- E-Type: meet CoC Version 5 (OWA-60E/90E);
comply with EU ErP
U-Type: Comply with EISA 2007/DoE and NRCan
- Class II power (without earth pin)
- Fanless design, cooling by free air convection
- Fully enclosed plastic case
- Protections: Short circuit / Over current /
Over voltage / Over temperature
- Suitable for household appliances or the electronic
applications at highly dusty or damp environment
- 5 years warranty

General Specification (Please refer to www.meanwell.com for detail spec.)

Model No.	OWA-60 <input type="checkbox"/>	OWA-90 <input type="checkbox"/>
AC input voltage range	90~264VAC; 127~370VDC	
Overload protection	E-Type: 105~115% hiccup mode, auto-recovery; U-Type: 95~108% constant current limiting, auto-recovery	
Over voltage protection	110%~140% rated output voltage, re-power on to recover	
Over temperature protection	Shut down output voltage, re-power on to recover	
Withstand voltage	I/P-O/P: 3.75KVAC	
Working temperature	-35~+70°C	-40~+70°C (refer to output derating curve)
Safety standards	E-Type: DEKRA BS EN/EN60335-1(except for 48~54V), EN61558-1/2-16 approved; U-Type: UL8750 listed approved, EAC TP TC 004	E-Type: DEKRA BS EN/EN60335-1(except for 42~54V), EN61558-1/2-16 approved; U-Type: UL8750 listed approved, EAC TP TC 004
EMC standards	E-Type: BS EN/EN55032 class B, EN55014, EN61000-3-2,-3; U-Type: FCC Part 15, EAC TP TC 020	
Standard plug	Input	E-Type: CEE 7/7 EU plug; U-Type: NEMA 1-15P plug
	Output	E-Type: XLR 4P, male type; U-Type: P1M, 2.5øx5.5øx11mm / C+, tuning fork type (OWA-90U 20~54V only) or R7B, Power DIN 4P with lock type
Refer to P73 for DC plug list	2.1øx5.5øx11mm / C+, tuning fork type	
Length of cable	Input	E-Type: 150cm of H05RN-F 1.0mm ² x2C; U-Type: 150cm of SVT 18AWGx2C
	Output	E-Type: 30cm of H05RN-F 1.0mm ² x2C U-Type: 30cm of UL2464 18AWG x4C for R7B; 30cm of UL2464 16AWGx2C for P1M

OWA-60 Series

Model No.	Output	Tol.	R&N	Effi.
OWA-60 <input type="checkbox"/> -12	12V, 0~5A	±4.0%	150mV	88%
OWA-60 <input type="checkbox"/> -15	15V, 0~4A	±4.0%	150mV	89%
OWA-60 <input type="checkbox"/> -20	20V, 0~3A	±4.0%	150mV	89%
OWA-60 <input type="checkbox"/> -24	24V, 0~2.5A	±3.0%	150mV	90%
OWA-60 <input type="checkbox"/> -30	30V, 0~2A	±3.0%	200mV	90%
OWA-60 <input type="checkbox"/> -36	36V, 0~1.67A	±2.0%	200mV	90%
OWA-60 <input type="checkbox"/> -42	42V, 0~1.5A	±1.0%	250mV	90%
OWA-60 <input type="checkbox"/> -48	48V, 0~1.25A	±1.0%	250mV	91%
OWA-60 <input type="checkbox"/> -54	54V, 0~1.12A	±1.0%	350mV	91%

= E / U ; E: European 2P, U: American 2P

OWA-90 Series

Model No.	Output	Tol.	R&N	Effi.
OWA-90 <input type="checkbox"/> -12	12V, 0~7.5A	±4.0%	150mV	89%
OWA-90 <input type="checkbox"/> -15	15V, 0~6A	±4.0%	150mV	90%
OWA-90 <input type="checkbox"/> -20-▲	20V, 0~4.5A	±4.0%	150mV	90%
OWA-90 <input type="checkbox"/> -24-▲	24V, 0~3.75A	±3.0%	150mV	90%
OWA-90 <input type="checkbox"/> -30-▲	30V, 0~3A	±3.0%	200mV	90%
OWA-90 <input type="checkbox"/> -36-▲	36V, 0~2.5A	±2.0%	200mV	91%
OWA-90 <input type="checkbox"/> -42-▲	42V, 0~2.15A	±1.0%	250mV	91%
OWA-90 <input type="checkbox"/> -48-▲	48V, 0~1.88A	±1.0%	250mV	91%
OWA-90 <input type="checkbox"/> -54-▲	54V, 0~1.67A	±1.0%	350mV	91%

= E / U ; E: European 2P, U: American 2P ; ▲=Blank(R7B)/P1M

Moistureproof Adaptor

120~200W IP67 Level





NEW

OWA-200E/U
195x 68x 39.5 mm



OWA-120E/U
191x 63x 37.5 mm

	E-Type	U-Type
AC Input Plug		
DC Output Plug	OWA-120E/200E 	OWA-120U/200U 

Features

- IP67 design for power body
- Class II power unit, no FG
- High efficiency up to 94%
- Universal AC input / Full range (OWA-120U/200U)
AC input 180~264VAC only (OWA-120E/200E)
- No load power consumption <0.15W
- Energy efficiency Level VI
- U-Type: Comply with EISA 2007/DoE and NRCAN
- Fanless design, cooling by free air convection
- Fully enclosed plastic case
- Protections: Short circuit / Over current /
Over voltage / Over temperature
- Suitable for household appliances or the electronic applications at highly dusty or damp environment
- 5 years warranty

General Specification (Please refer to www.meanwell.com for detail spec.)

Model No.	OWA-120 <input type="checkbox"/>	OWA-200 <input type="checkbox"/>
AC input voltage range	U Type: 90~264VAC; 127~370VDC ; E Type: 180~264VAC ; 254~370VDC	
Overload protection	E-Type: 105~115% hiccup mode, auto-recovery; U-Type: 95~108% constant current limiting, auto-recovery	105% ~ 150% hiccup mode, auto-recovery
Over voltage protection	110%~140% rated output voltage, re-power on to recover	150%~200% rated output voltage, re-power on to recover
Over temperature protection	Shut down output voltage, re-power on to recover	
Withstand voltage	I/P-O/P: 3.75KVAC	I/P-O/P:4.2KVAC
Working temperature	-40~+70°C (refer to output derating curve)	
Safety standards	E-Type: DEKRA BS EN/EN60335-1(except for 48~54V), EN61558-1/2-16 approved; U-Type: UL8750 listed approved, EAC TP TC 004	E-Type: DEKRA BS EN/EN60335-1(except for 48~54V), EN61558-1/2-16 approved; U-Type: UL62368-1 listed approved, EAC TP TC 004
EMC standards	E-Type: BS EN/EN55032 class B, EN55014, EN61000-3-2, -3; U-Type: FCC Part 15, EAC TP TC 020	E-Type: BS EN/EN55032 class B, EN55035, EN55014-1, EN61000-3-2/3; U-Type: FCC Part 15, EAC TP TC 020
Standard plug	Input	E-Type: CEE 7/7 EU plug; U-Type: NEMA 1-15P plug
	Output	E-Type: XLR4P; U-Type: KYCON KPPX-4P R7B
Refer to P73 for DC plug list		
Length of cable	Input	E-Type: 150cm of H05RN-F 1.0mm ² x2C; U-Type: 150cm of SVT 18AWGx2C
	Output	E-Type: 30cm of H07RN-F 1.5mm ² x2C U-Type: 30cm of UL2464 18AWG x4C
		E-Type: 100cm SJOW 14AWGx2C U-Type: 100cm UL2464 16AWG x4C

OWA-120 Series

Model No.	Output	Tol.	R&N	Effi.
OWA-120E-12	12V, 0~9.6A	±4.0%	150mV	87.5%
OWA-120U-12	12V, 0~10A	±4.0%	150mV	87.5%
OWA-120 <input type="checkbox"/> -15	15V, 0~8A	±4.0%	150mV	89.0%
OWA-120 <input type="checkbox"/> -20	20V, 0~6A	±4.0%	150mV	90.0%
OWA-120 <input type="checkbox"/> -24	24V, 0~5A	±4.0%	150mV	90.5%
OWA-120 <input type="checkbox"/> -30	30V, 0~4A	±3.0%	200mV	90.0%
OWA-120 <input type="checkbox"/> -36	36V, 0~3.4A	±2.0%	200mV	90.0%
OWA-120 <input type="checkbox"/> -42	42V, 0~2.9A	±1.0%	250mV	90.5%
OWA-120 <input type="checkbox"/> -48	48V, 0~2.5A	±1.0%	250mV	90.5%
OWA-120 <input type="checkbox"/> -54	54V, 0~2.3A	±1.0%	350mV	90.5%

= E / U ; E: European 2P, U: American 2P

OWA-200 Series

Model No.	Output	Tol.	R&N	Effi.
OWA-200E-12	12V, 0~15A	±5.0%	150mV	91.0%
OWA-200U-12	12V, 0~15A	±5.0%	150mV	91.0%
OWA-200 <input type="checkbox"/> -20	20V, 0~10A	±4.0%	150mV	92.5%
OWA-200 <input type="checkbox"/> -24	24V, 0~8.3A	±4.0%	150mV	93.0%
OWA-200 <input type="checkbox"/> -36	36V, 0~5.55A	±4.0%	200mV	94.0%
OWA-200 <input type="checkbox"/> -42	42V, 0~4.75A	±3.0%	250mV	94.0%
OWA-200 <input type="checkbox"/> -48	48V, 0~4.17A	±3.0%	250mV	94.0%
OWA-200 <input type="checkbox"/> -54	54V, 0~3.71A	±3.0%	350mV	94.0%

= E / U ; E: European 2P, U: American 2P

Changeable DC Plug Converter Selection Guide

- Flexible solution for small quantity
- Easy modification for different size of DC plug

- Off-the-shelf and no MOQ
- ※ If you can't find the required DC plug in this table, please contact MEAN WELL's sales reps.

Adaptor	Changeable DC Plug	Assembly Illustration (Example)
<p>Model No.</p> <p>GST18~60 GSM06~60 GEM06~60 GE12~40 SGA12~60 GS06/15 OWA-60U/E</p>  <p>Standard DC Plug 2.1x 5.5x 11mm</p>	<p>Ordering No.</p> <p>DC PLUG-P1J-P1I 2.1x 5.5x 9.5mm DC PLUG-P1J-P1M 2.5x 5.5x 11mm DC PLUG-P1J-P1L 2.5x 5.5x 9.5mm DC PLUG-P1J-P3A 0.7x 2.35x 11mm DC PLUG-P1J-P3B 1.7x 4.0x 11mm DC PLUG-P1J-P3C 1.7x 4.75x 11mm DC PLUG-P1J-P4A 3.4x 5.5x 11x 1mm DC PLUG-P1J-P4B 4.4x 6.5x 11x 1.4mm DC PLUG-P1J-P4C 5.1x 7.4x 11x 0.6mm</p> <hr/> <p>DC PLUG-P1J-P1IR 2.1x 5.5x 9.5mm DC PLUG-P1J-P1MR 2.5x 5.5x 11mm DC PLUG-P1J-P1LR 2.5x 5.5x 9.5mm DC PLUG-P1J-P1JR 2.1x 5.5x 11mm DC PLUG-P1M-P1MR 2.5x 5.5x 11mm</p> <hr/> <p>DC PLUG-P1J-R6B KYCON KPPX-3P DC PLUG-P1J-R7B KYCON KPPX-4P DC PLUG-P1J-R1B 5PIN DIN</p>	
<p>Model No.</p> <p>GST90~120 GSM90</p>  <p>Standard DC Plug 2.5x 5.5x 11mm</p>	<p>Ordering No.</p> <p>DC PLUG-P1M-P1J 2.1x 5.5x 11mm</p> <hr/> <p>DC PLUG-P1M-P1JR 2.1x 5.5x 11mm</p> <hr/> <p>DC PLUG-P1M-R7B KYCON KPPX-4P</p>	
<p>Model No.</p> <p>GST120~220 GSM120~220 OWA-90U~200U</p>  <p>KPPX-4P Equivalent</p>	<p>Ordering No.</p> <p>DC PLUG-R7BF-P1J 2.1x 5.5x 11mm DC PLUG-R7BF-P1M 2.5x 5.5x 11mm</p>	

Note : Please refer to MEAN WELL adaptor specifications for DC plug rating and compatibility.

Medical Adaptor

6~25W High Reliable Green Medical Grade



Features

- Universal AC input / Full range
- **Medical safety approved(2xMOPP)**
- Suitable for **BF** application with appropriate system consideration
- Extremely low leakage current
- No load power consumption <0.075~0.3W by models
- Energy efficiency **Level VI** (GSM06 and GSM18/25 5~9V for Level V)
- Comply with EISA 2007/DoE, NRCAN, AU/NZ MEPS, EU ErP and meet CoC Version 5(GSM18/25); EISA 2007 and EU ErP(GSM06)
- Class II power(without earth pin)
- Protections: Short circuit / Overload / Over voltage
- Fully enclosed plastic case
- LED indicator for power on(except for GSM06/12)
- Optional lock type DC plug
- Certificates: B-Type: UL / CUL / TUV / CB / EAC / FCC / CE
U-Type: UL / CUL / CB / EAC / FCC
E-Type: TUV / CB / EAC / CE
- **3 years warranty**

General Specification (Please refer to www.meanwell.com for detail spec.)



Order No.	GSM06□	GSM12□	GSM18□	GSM25□
AC input voltage range	80~264VAC; 113~370VDC			
Leakage current	<50μA	<100μA	<50μA	
Setup, rise, hold up time	1000ms, 50ms, 12ms	500ms, 30ms, 16ms	500ms, 30ms, 16ms	
Withstand voltage	I/P-O/P: 5656VDC		I/P-O/P: 4kVAC	
Working temperature	0~+50°C	-20~+70°C	-25~+60°C (refer to output derating curve)	
Safety standards	B-Type(except for GSM06/12): ANSI/AAMI ES60601-1/ES60601-1-11, CAN/CSA-C22, TUV BS EN/EN60601-1 / EN60601-1-11 , EAC TP TC 004 approved U-Type: ANSI/AAMI ES60601-1, ES60601-1-11 , CAN/CSA-C22, EAC TP TC 004 approved E-Type: TUV BS EN/EN60601-1 / EN60601-1-11 , EAC TP TC 004 approved			
EMC standards	B-Type(except for GSM06/12): BS EN/EN55011 class B, EN61000-3-2,3, EN61000-4-2,3,4,5,6,8,11, EN61204-3, EN60601-1-2 medical level, FCC Part 15 class B, EAC TP TC 020 U-Type: FCC Part 15 class B, EAC TP TC 020 E-Type: BS EN/EN55011 class B, EN61000-3-2,3, EN61000-4-2,3,4,5,6,8,11, EN61204-3, EN60601-1-2 medical level, EAC TP TC 020			
Length of output cable	120cm, 22AWG for 5~9V; 180cm, 24AWG for 12~24V	100cm , 18AWG for 5~7.5V 120cm , 22AWG for 9V 180cm , 24AWG for 12~48V	120cm of UL1185, 16AWG for GSM18/25 5~9V; 180cm of UL1185, 16AWG for GSM25 12V; 180cm of UL1185, 18AWG for GSM18 12~48V and GSM25 15~48V	
Standard DC plug	P1J: 2.1øx 5.5øx 11mm / C+, tuning fork type (refer to page 73 for DC plug list)			
Dimension (LxWxH)(mm)	66x 32x 42.5	62.2x 27.4x 45.5	79x 54x 33	

Wall-mounted — 6W

Model No.	Output	Tol.	R&N	Effi.	Model No.	Output	Tol.	R&N	Effi.
GSM06□05-P1J	5V, 0~1.20A	±5%	50mV	68%	GSM06□15-P1J	15V, 0~0.40A	±5%	120mV	79%
GSM06□06-P1J	6V, 0~1.00A	±5%	50mV	74%	GSM06□18-P1J	18V, 0~0.33A	±5%	150mV	80%
GSM06□07-P1J	7.5V, 0~0.80A	±5%	80mV	74%	GSM06□24-P1J	24V, 0~0.25A	±4%	180mV	82%
GSM06□09-P1J	9V, 0~0.66A	±5%	80mV	76%	□ = U / E ; U: American 2P, E: European 2P				
GSM06□12-P1J	12V, 0~0.50A	±5%	100mV	77%					

Wall-mounted — 12W

Model No.	Output	Tol.	R&N	Effi.	Model No.	Output	Tol.	R&N	Effi.
GSM12□05-USB	5V, 0~2.40A	±5%	60mV	80%	GSM12□15-P1J	15V, 0~0.8A	±3%	80mV	84%
GSM12□05-P1J	5V, 0~2.40A	±5%	60mV	80%	GSM12□18-P1J	18V, 0~0.66A	±3%	80mV	85%
GSM12□07-P1J	7.7V, 0~1.00A	±5%	60mV	82%	GSM12□24-P1J	24V, 0~0.50A	±2%	80mV	85%
GSM12□09-P1J	9.5V, 0~1.33A	±4%	60mV	82%	GSM12□48-P1J	48V, 0~0.25A	±2%	100mV	87%
GSM12□12-P1J	12V, 0~1.00A	±3%	80mV	82.5%	□ = U / E ; U: American 2P, E: European 2P				

Desktop / Wall-mounted — 18W

Model No.	Output	Tol.	R&N	Effi.	Model No.	Output	Tol.	R&N	Effi.
GSM18□05-P1J	5V, 0~3.00A	±5%	60mV	80%	GSM18□18-P1J	18V, 0~1.00A	±3%	150mV	86%
GSM18□07-P1J	7.5V, 0~2.00A	±5%	80mV	83%	GSM18□24-P1J	24V, 0~0.75A	±2%	180mV	87%
GSM18□09-P1J	9V, 0~2.00A	±5%	80mV	84%	GSM18□48-P1J	48V, 0~0.375A	±2%	240mV	88%
GSM18□12-P1J	12V, 0~1.50A	±3%	120mV	85%	□ = B / U / E ; B: IEC320-C8, U: American 2P, E: European 2P				
GSM18□15-P1J	15V, 0~1.20A	±3%	120mV	85.5%					

Desktop / Wall-mounted — 25W

Model No.	Output	Tol.	R&N	Effi.	Model No.	Output	Tol.	R&N	Effi.
GSM25□05-P1J	5V, 0~4.00A	±6%	60mV	80%	GSM25□18-P1J	18V, 0~1.38A	±3%	150mV	86%
GSM25□07-P1J	7.5V, 0~2.93A	±5%	80mV	83%	GSM25□24-P1J	24V, 0~1.04A	±2%	180mV	87%
GSM25□09-P1J	9V, 0~2.77A	±5%	80mV	84%	GSM25□48-P1J	48V, 0~0.52A	±2%	240mV	88%
GSM25□12-P1J	12V, 0~2.08A	±3%	120mV	86%	□ = B / U / E ; B: IEC320-C8, U: American 2P, E: European 2P				
GSM25□15-P1J	15V, 0~1.66A	±3%	120mV	86%					

Medical Adaptor 36~60W High Reliable Green Medical Grade

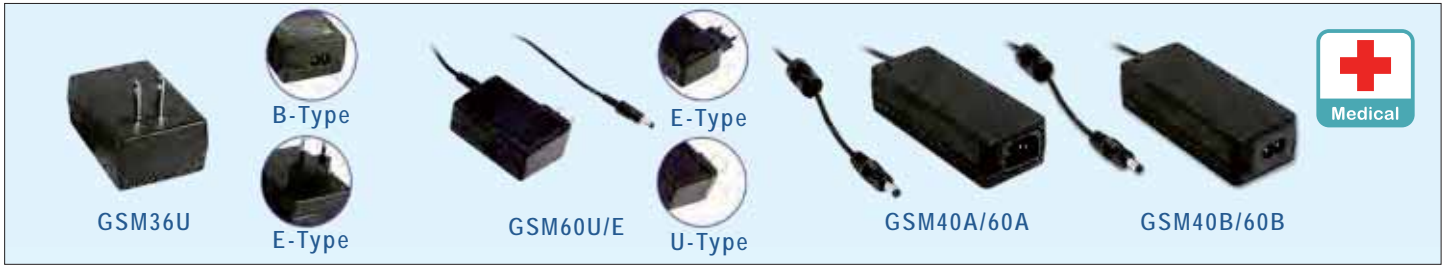

Features

- Medical safety approved(2xMOPP)
- Suitable for BF application with appropriate system consideration (U/E/B-Type only)
- Extremely low leakage current
- Energy efficiency Level VI
- Comply with EISA 2007/DoE, NRCAN, AU/NZ MEPS, EU ErP and meet CoC Version 5
- Class I(with earth Pin): A-Type
Class II(without earth Pin): B/U/E-Type
- Protections: Short circuit / Overload / Over voltage / Over temperature (GSM60A/B)
- LED indicator for power on (except for GSM60U/E)
- 3 years warranty



General Specification (Please refer to www.meanwell.com for detail spec.)

Order No.	GSM36□	GSM60U	GSM60E	GSM40A	GSM60A	GSM40B	GSM60B
AC input voltage range	80~264VAC; 113~370VDC						
Leakage current	<50μA		U/E/A-Type: <100μA, B-Type: <50μA				
Withstand voltage	I/P-O/P: 4kVAC		A-Type: I/P-O/P: 4kVAC, I/P-FG: 2kVAC, O/P-FG: Short ; B-Type: I/P-O/P: 4kVAC E/U-Type: 5656VDC				
Working temperature	-25~+60°C		-30~+70°C (refer to output derating curve)				
Safety standards	A-Type: ANSI/AAMI ES60601-1, CAN/CSA-C22, TUV BS EN/EN60601-1, EAC TP TC 004 approved B/E-Type: ANSI/AAMI ES60601-1, CAN/CSA-C22, ES60601-1-11 , TUV BS EN/EN60601-1 / EN60601-1-11 , EAC TP TC 004 approved U-Type: ANSI/AAMI ES60601-1, CAN/CSA-C22, ES60601-1-11						
EMC standards	GSM36 B-Type: BS EN/EN55011 class B, EN61000 -3-2,3, EN61000-4-2,3,4,5,6,8,11, EN61204-3, EN60 601-1-2 medical level, FCC Part 15 class B, EAC TP TC 020; KC K60950.1 for GSM40B48-P1J only U-Type: FCC Part 15 class B, EAC TP TC 020 E-Type : BS EN/EN55011 class B, EN61000-3-2,3, EN61000-4-2,3,4,5,6,8,11, EN61204-3, EN60601-1-2 medical level, EAC TP TC 020 GSM40/60 BS EN/EN55011 class B, EN61000-3-2,3, EN61000-4-2,3,4,5,6,8,11, EN61204-3, EN60601-1-2 medical level, FCC Part 15 class B						
Length of output cable	GSM36 120cm of UL1185, 16AWG for 5~9V; 180cm of UL1185, 16AWG for 12V~48V; GSM40/60 100cm: GSM60U/E 5~18V, GSM40A/B 5~12V and GSM60A/B 5~15V 150cm: GSM60U/E 24~48V, GSM40A/B 15~48V and GSm60A/B 18~48V						
Standard DC plug (refer to page 73 for DC plug list)	P1J: 2.1øx5.5øx11mm/c+, tuning fork type						
Dimension (LxWxH)(mm)	79x 54x 33		75.5x 32x 47.5 (Slim Width)		125x 50x 31.5		

Desktop/ Wall-mounted — 36W

Order No.	Output	Tol.	R&N	Effi.
GSM36□05-P1J	5V, 0~4.50A	±6%	80mV	80%
GSM36□07-P1J	7.5V, 0~4.32A	±5%	80mV	83%
GSM36□09-P1J	9V, 0~4.00A	±5%	80mV	84%
GSM36□12-P1J	12V, 0~3.00A	±3%	120mV	86%
GSM36□15-P1J	15V, 0~2.40A	±3%	120mV	87%
GSM36□18-P1J	18V, 0~2.00A	±3%	150mV	87%
GSM36□24-P1J	24V, 0~1.50A	±2%	180mV	87%
GSM36□48-P1J	48V, 0~0.75A	±2%	240mV	88%

□ = B / U / E ;
B: IEC320-C8, U: American 2P, E: European 2P

Desktop — 40W

Order No.	Output	Tol.	R&N	Effi.
GSM40□05-P1J	5V, 0.1~5A	±5%	80mV	81.0%
GSM40□07-P1J	7.5V, 0.1~5.34A	±5%	80mV	85.5%
GSM40□09-P1J	9V, 0.1~4.45A	±5%	100mV	86.0%
GSM40□12-P1J	12V, 0.1~3.34A	±3%	100mV	88.0%
GSM40□15-P1J	15V, 0.1~2.67A	±3%	100mV	88.5%
GSM40□18-P1J	18V, 0.1~2.22A	±3%	120mV	89.5%
GSM40□24-P1J	24V, 0.1~1.67A	±2.5%	150mV	90.0%
GSM40□48-P1J	48V, 0.1~0.84A	±2.5%	150mV	91.0%

□ = A / B; A: IEC 320-C14 / Class I, B: IEC 320-C8 / Class II

Wall-mounted — 60W

Order No.	Output	Tol.	R&N	Effi.
GSM60□05-P1J	5V, 0~6.00A	±5%	100mV	80%
GSM60□07-P1J	7.5V, 0~6.00A	±5%	100mV	85%
GSM60□09-P1J	9V, 0~5.50A	±5%	100mV	87%
GSM60□12-P1J	12V, 0~4.50A	±5%	100mV	88%
GSM60□15-P1J	15V, 0~4.00A	±5%	120mV	88%
GSM60□18-P1J	18V, 0~3.33A	±3%	120mV	88%
GSM60□24-P1J	24V, 0~2.50A	±3%	120mV	88%
GSM60□48-P1J	48V, 0~1.25A	±3%	150mV	90%

□ = U / E ; U: American 2P, E: European 2P

Desktop — 60W

Order No.	Output	Tol.	R&N	Effi.
GSM60□05-P1J	5V, 0.1~6A	±5%	80mV	81.5%
GSM60□07-P1J	7.5V, 0.1~6A	±5%	80mV	86.0%
GSM60□09-P1J	9V, 0.1~6A	±5%	100mV	87.5%
GSM60□12-P1J	12V, 0.1~5A	±3%	100mV	88.0%
GSM60□15-P1J	15V, 0.1~4A	±3%	100mV	88.5%
GSM60□18-P1J	18V, 0.1~3.33A	±3%	120mV	89.0%
GSM60□24-P1J	24V, 0.1~2.5A	±3%	150mV	90.5%
GSM60□48-P1J	48V, 0.1~1.25A	±2.5%	240mV	91.5%

□ = A / B; A: IEC 320-C14 / Class I, B: IEC 320-C8 / Class II

Medical Adaptor

90~120W High Reliable Green Medical Grade



Features

- Universal AC input / Full range
- **Medical safety approved (2xMOPP)**
- Suitable for **BF** application with appropriate system consideration (B-Type only)
- Extremely low leakage current
- No load power consumption <0.15W
- Energy efficiency **Level VI**
- Comply with EISA 2007/DoE, NRCAN, AU/NZ MEPS, EU ErP and meet CoC Version 5
- A-Type: Class I (with earth Pin); B-Type: Class II (without earth Pin)
- Protections: Short circuit / Overload / Over voltage / Over temp.
- Fully enclosed plastic case
- LED indicator for power on
- Optional lock type DC plug
- **3 years warranty**

General Specification (Please refer to www.meanwell.com for detail spec.)



Order No.	GSM90A	GSM90B	GSM120A	GSM120B
AC input voltage range	80~264VAC; 113~370VDC			
Leakage current	<115μA	<100μA	<115μA	<100μA
Overload protection	Range	110%~150% rated output power		105%~160% rated output power
	Type	Hiccup mode, auto-recovery		
Over voltage protection	Range	105%~135% rated output voltage		
	Type	Shut down o/p voltage, re-power on to recover		
Setup, rise, hold up time	1000ms, 50ms, 40ms	1000ms, 50ms, 30ms	1500ms, 30ms, 40ms	
Withstand voltage	A-Type: I/P-O/P: 4kVAC, I/P-FG: 2kVAC, O/P-FG: Short B-Type: I/P-O/P: 4kVAC		A-Type: I/P-O/P: 4kVAC, I/P-FG: 2kVAC, O/P-FG: 0.5kVAC, B-Type: I/P-O/P: 4kVAC	
Working temperature	-30~+70°C (refer to output derating curve)			
Safety standards	A-Type: ANSI/AAMI ES60601-1, CAN/CSA-C22, TUV BS EN/EN60601-1, EAC TP TC 004 approved B-Type: ANSI/AAMI ES60601-1, CAN/CSA-C22, ES60601-1-11 , TUV BS EN/EN60601-1, EN60601-1-11 , EAC TP TC 004 approved			
EMC standards	BS EN/EN55011 class B, EN61000-3-2,3, EN61000-4-2,3,4,5,6,8,11, EN61204-3, EN60601-1-2 medical level, FCC Part 15 class B, EAC TP TC 020			
Length of output cable	100cm of UL1185, 14AWG for 12~15V; 120cm of UL1185, 16AWG for 19~48V		100cm of UL2464, 18AWGx4C for 12V; 120cm of UL2464, 18AWGx4C for 15~48V	
Standard DC plug (refer to page 73 for DC plug list)	P1M: 2.5øx5.5øx11mm/c+, tuning fork type		R7B: Power DIN 4P with lock type	
Dimension (LxWxH)(mm)	145x 60x 32		167x 67x 35	

Desktop (IEC 320-C14 / Class I) — 90W

Model No.	Output	Tol.	R&N	Effi.
GSM90A12-P1M	12V, 0~6.67A	±5%	120mV	88.0%
GSM90A15-P1M	15V, 0~6.00A	±5%	120mV	89.0%
GSM90A19-P1M	19V, 0~4.74A	±4%	120mV	89.0%
GSM90A24-P1M	24V, 0~3.75A	±3%	180mV	90.0%
GSM90A48-P1M	48V, 0~1.87A	±2.5%	200mV	91.0%

Desktop (IEC 320-C8 / Class II) — 90W

Model No.	Output	Tol.	R&N	Effi.
GSM90B12-P1M	12V, 0~6.67A	±5%	120mV	88.0%
GSM90B15-P1M	15V, 0~6.00A	±5%	120mV	89.0%
GSM90B19-P1M	19V, 0~4.74A	±4%	120mV	89.0%
GSM90B24-P1M	24V, 0~3.75A	±3%	180mV	90.0%
GSM90B48-P1M	48V, 0~1.87A	±2.5%	200mV	91.0%

Desktop (IEC 320-C14 / Class I) — 120W

Model No.	Output	Tol.	R&N	Effi.
GSM120A12-R7B	12V, 0~8.50A	±5%	100mV	88.0%
GSM120A15-R7B	15V, 0~7.00A	±5%	120mV	89.0%
GSM120A20-R7B	20V, 0~6.00A	±4%	180mV	89.0%
GSM120A24-R7B	24V, 0~5.00A	±3%	180mV	90.0%
GSM120A48-R7B	48V, 0~2.50A	±2.5%	200mV	91.5%

Desktop (IEC 320-C8 / Class II) — 120W

Model No.	Output	Tol.	R&N	Effi.
GSM120B12-R7B	12V, 0~8.50A	±5%	100mV	88.0%
GSM120B15-R7B	15V, 0~7.00A	±5%	120mV	89.0%
GSM120B20-R7B	20V, 0~6.00A	±4%	150mV	89.5%
GSM120B24-R7B	24V, 0~5.00A	±3%	180mV	90.0%
GSM120B48-R7B	48V, 0~2.50A	±2.5%	200mV	91.5%

Medical Adaptor

160~220W High Reliable Green Medical Grade



Features

- Universal AC input / Full range
- **Medical safety approved (2xMOPP)**
- Suitable for **BF** application with appropriate system consideration (B-Type only)
- Extremely low leakage current
- No load power consumption < 0.15W
- Energy efficiency **Level VI**
- Comply with EISA 2007/DoE, NRCAN, AU/NZ MEPS, EU ErP and meet CoC Version 5
- High efficiency up to 94.5%
- **Fanless design, high operating temperature up to +70°C**
- A-Type: Class I (with earth Pin); B-Type: Class II (without earth Pin)
- Protections: Short circuit / Overload / Over voltage / Over temp.
- Fully enclosed plastic case
- LED indicator for power on
- **3 years warranty**



General Specification (Please refer to www.meanwell.com for detail spec.)



Order No.	GSM160A	GSM160B	GSM220A	GSM220B	
AC input voltage range	80~264VAC; 113~370VDC				
Leakage current	<115μA	<100μA	<115μA	<100μA	
Overload protection	Range	105%~150% rated output power		105%~135% rated output power	
	Type	Hiccup mode, auto-recovery			
Over voltage protection	Range	105%~135% rated output voltage			
	Type	Shut down o/p voltage, re-power on to recover			
Setup, rise, hold up time	2000ms, 50ms, 24ms				
Withstand voltage	A-Type: I/P-O/P: 4kVAC, I/P-FG: 2kVAC, O/P-FG: 0.5kVAC; B-Type: I/P-O/P: 4kVAC				
Working temperature	-30~+70°C (refer to output derating curve)				
Safety standards	A-Type: ANSI/AAMI ES60601-1, CAN/CSA-C22, TUV BS EN/EN60601-1, EAC TP TC 004 approved B-Type: ANSI/AAMI ES60601-1, CAN/CSA-C22, ES60601-1-11 , TUV BS EN/EN60601-1, EAC TP TC 004, EN60601-1-11 approved				
EMC standards	BS EN/EN55011 class B, EN61000-3-2,3, EN61000-4-2,3,4,5,6,8,11, EN61204-3, EN60601-1-2 medical level, FCC Part 15 class B, EAC TP TC 020				
Length of output cable	100cm of UL2464, 16AWGx4C for 12V; 120cm of UL2464, 18AWGx4C for 15~48V		100cm of UL2464, 16AWGx4C		
Standard DC plug (refer to page 73 for DC plug list)	R7B: power DIN 4P with lock type				
Dimension (LxWxH)(mm)	175x 72x 35		210x 85x 46		

Desktop (IEC 320-C14 / Class I) – 160W

Order No.	Output	Tol.	R&N	Effi.
GSM160A12-R7B	12V, 0~11.5A	±5%	80mV	90.0%
GSM160A15-R7B	15V, 0~9.6A	±5%	100mV	91.0%
GSM160A20-R7B	20V, 0~8.0A	±4%	100mV	92.5%
GSM160A24-R7B	24V, 0~6.67A	±3%	120mV	93.0%
GSM160A48-R7B	48V, 0~3.34A	±3%	150mV	94.0%

Desktop (IEC 320-C8 / Class II) – 160W

Order No.	Output	Tol.	R&N	Effi.
GSM160B12-R7B	12V, 0~11.5A	±5%	80mV	90.0%
GSM160B15-R7B	15V, 0~9.6A	±5%	100mV	91.0%
GSM160B20-R7B	20V, 0~8.0A	±4%	120mV	92.5%
GSM160B24-R7B	24V, 0~6.67A	±3%	120mV	93.5%
GSM160B48-R7B	48V, 0~3.34A	±3%	150mV	94.0%

Desktop (IEC 320-C14 / Class I) – 220W

Order No.	Output	Tol.	R&N	Effi.
GSM220A12-R7B	12V, 0~15.0A	±5%	80mV	90.0%
GSM220A15-R7B	15V, 0~13.4A	±5%	80mV	90.0%
GSM220A20-R7B	20V, 0~11.0A	±4%	120mV	92.0%
GSM220A24-R7B	24V, 0~9.20A	±3%	120mV	93.5%
GSM220A48-R7B	48V, 0~4.60A	±2%	150mV	94.5%

Desktop (IEC 320-C8 / Class II) – 220W

Order No.	Output	Tol.	R&N	Effi.
GSM220B12-R7B	12V, 0~15.0A	±5%	80mV	90.0%
GSM220B15-R7B	15V, 0~13.4A	±5%	80mV	90.0%
GSM220B20-R7B	20V, 0~11.0A	±4%	120mV	92.0%
GSM220B24-R7B	24V, 0~9.20A	±3%	120mV	93.5%
GSM220B48-R7B	48V, 0~4.60A	±2%	150mV	94.5%

Medical Adaptor

6~18W High Reliable Green Interchangeable Type



NEW GEM061/121 73.9x 39x 48.5 mm
GEM181 75.5x 39.1x 56.2 mm

Features

- Interchangeable AC plugs (plug kit sold separately)
- Medical safety approved (2xMOPP)
- Suitable for BF application with appropriate system consideration
- No load power consumption <0.075W (<0.1W for GEM12118V/48V)
- Energy efficiency Level VI (Level V for GEM061)
- Comply with EISA 2007/DoE and EU ErP
- Class II power (without earth pin)
- Protections: Short circuit / Overload / Over voltage
- Extremely low leakage current
- Fully enclosed plastic case
- IP21 or IP22 by models
- 3 years warranty



General Specification (Please refer to www.meanwell.com for detail spec.)

Order No.	GEM061	GEM121	GEM181
AC input voltage range	80~264VAC; 113~370VDC		
Leakage current	<55µA	<100µA	
Withstand voltage	I/P-O/P: 5656VDC, 1 minute		
Working temperature	-20~+70°C		-20~+50°C
Safety standards	TUV BS EN/EN60601-1/EN60601-1-11, ANSI/ AAMI ES60601-1/ES60601-1-11(3.1 version), CAN/CSA-C22, EAC TP TC 004, GEM06 05-USB without EN60601-1-11, ANSI/ AAMII ES60601-1-11	ANSI/AAMI ES60601-1/60601-1-11, CAN/CSA-C22, TUV BS EN/EN60601-1/60601-1-11 approved	
EMC standards	BS EN/EN55011 Class B, EN61000-3-2,3, EN61000-4-2,3,4,5,6,8,11, FCC part18 class B		
Length of output cable	5~9V: 120cm 12~24V: 180cm	5~7.5V: 100cm 9V: 120cm 12~48V: 180cm	5~12V: 100cm 15~48V: 150cm
Standard DC plug	P1J: 2.1øx5.5øx11mm/C+, turning fork type (refer to page 73 for DC plug list)		

Wall-mounted(Interchangeable Type)—6W **NEW**

Order No. (main body)	Output	Tol.	R&N	Effi.
GEM06105-USB	5V, 0~1.2A	±5%	50mV	70%
GEM06105-P1J	5V, 0~1.2A	±5%	50mV	70%
GEM06106-P1J	6V, 0~1.0A	±5%	50mV	74%
GEM06107-P1J	7.5V, 0~0.8A	±5%	80mV	74%
GEM06109-P1J	9V, 0~0.66A	±5%	80mV	76%
GEM06112-P1J	12V, 0~0.5A	±5%	100mV	76%
GEM06115-P1J	15V, 0~0.4A	±5%	120mV	79%
GEM06118-P1J	18V, 0~0.33A	±5%	150mV	79%
GEM06124-P1J	24V, 0~0.25A	±4%	180mV	80%

Wall-mounted(Interchangeable Type)—12W

Order No. (main body)	Output	Tol.	R&N	Effi.
GEM12105-USB	5V, 0~2.4A	±5%	60mV	80%
GEM12105-P1J	5V, 0~2.4A	±5%	60mV	80%
GEM12107-P1J	7.5V, 0~1.6A	±5%	60mV	82%
GEM12109-P1J	9V, 0~1.33A	±4%	60mV	82%

Order No. (main body)	Output	Tol.	R&N	Effi.
GEM12112-P1J	12V, 0~1A	±3%	80mV	82.5%
GEM12115-P1J	15V, 0~0.8A	±3%	80mV	84%
GEM12118-P1J	18V, 0~0.66A	±3%	80mV	85%
GEM12124-P1J	24V, 0~0.5A	±2%	80mV	85%
GEM12148-P1J	48V, 0~0.25A	±2%	100mV	87%

Wall-mounted(Interchangeable Type)—18W

Order No. (main body)	Output	Tol.	R&N	Effi.
GEM18105-P1J	5V, 0~3.00A	±5%	60mV	80%
GEM18109-P1J	9V, 0~2.00A	±5%	60mV	84%
GEM18112-P1J	12V, 0~1.50A	±3%	80mV	84%
GEM18115-P1J	15V, 0~1.20A	±3%	80mV	84%
GEM18118-P1J	18V, 0~1.00A	±2%	80mV	84%
GEM18124-P1J	24V, 0~0.75A	±2%	80mV	85%
GEM18148-P1J	48V, 0~0.375A	±2%	80mV	87%

Medical Adaptor

30~60W High Reliable Green Interchangeable Type



GEM301/401 75.5x 39.1x 56.2 mm
GEM601 75.5x 39.1x 56.2 mm

Features

- Interchangeable AC plugs (plug kit sold separately)
- Medical safety approved (2xMOPP)
- Suitable for BF application with appropriate system consideration
- No load power consumption <0.075W (<0.1W for GEM301/401, <0.15W for GEM601)
- Energy efficiency **Level VI**
- Comply with EISA 2007/DoE and EU ErP
- Class II power (without earth pin)
- Protections: Short circuit / Overload / Over voltage
- Extremely low leakage current
- Fully enclosed plastic case
- IP21 or IP22 by models
- 3 years warranty

General Specification (Please refer to www.meanwell.com for detail spec.)



Order No.	GEM301	GEM401	GEM601
AC input voltage range	80~264VAC; 113~370VDC		
Leakage current	<100μA		
Withstand voltage	I/P-O/P: 5656VDC, 1 minute		
Working temperature	-25~+70°C (refer to output derating curve)		-30~+70°C
Safety standards	ANSI/AAMI ES60601-1/60601-1-11, CAN/CSA-C22, TUV BS EN/EN60601-1/60601-1-11 approved (GEM181 TUV&UL60601-1 only)		
EMC standards	BS EN/EN55011 Class B, EN61000-3-2,3, EN61000-4-2,3,4,5,6,8,11, FCC part18 class B		
Length of output cable	5~12V: 100cm 15~24V: 150cm 48V: 180cm	5~15V: 100cm 18~48V: 150cm	5~18V: 100cm 24~48V: 150cm
Standard DC plug	P1J: 2.1øx5.5øx11mm/C+, turning fork type (refer to page 73 for DC plug list)		

Wall-mounted(Interchangeable Type)—30W

Order No. (main body)	Output	Tol.	R&N	Effi.
GEM30105-P1J	5V, 0~4.00A	±5%	100mV	82%
GEM30107-P1J	7.5V, 0~3.33A	±5%	100mV	86%
GEM30109-P1J	9V, 0~3.33A	±5%	100mV	87%
GEM30112-P1J	12V, 0~2.50A	±3%	100mV	87%
GEM30115-P1J	15V, 0~2.00A	±3%	100mV	87%
GEM30118-P1J	18V, 0~1.66A	±2%	100mV	88%
GEM30124-P1J	24V, 0~1.25A	±2%	100mV	88.5%
GEM30148-P1J	48V, 0~0.625A	±2%	100mV	90%

Order No. (main body)	Output	Tol.	R&N	Effi.
GEM40115-P1J	15V, 0~2.66A	±3%	120mV	88%
GEM40118-P1J	18V, 0~2.22A	±2%	120mV	88%
GEM40124-P1J	24V, 0~1.66A	±2%	120mV	89%
GEM40148-P1J	48V, 0~0.83A	±2%	200mV	90.5%

Wall-mounted(Interchangeable Type)—40W

Order No. (main body)	Output	Tol.	R&N	Effi.
GEM40105-P1J	5V, 0~5.00A	±5%	100mV	84%
GEM40109-P1J	9V, 0~4.00A	±5%	100mV	87%
GEM40112-P1J	12V, 0~3.33A	±3%	100mV	88%

Wall-mounted(Interchangeable Type)—60W

Order No. (main body)	Output	Tol.	R&N	Effi.
GEM60105-P1J	5V, 0~6.00A	±5%	100mV	80%
GEM60107-P1J	7.5V, 0~6.00A	±5%	100mV	85%
GEM60109-P1J	9V, 0~5.50A	±5%	100mV	87%
GEM60112-P1J	12V, 0~4.50A	±5%	100mV	88%
GEM60115-P1J	15V, 0~4.00A	±5%	120mV	88%
GEM60118-P1J	18V, 0~3.33A	±3%	120mV	88%
GEM60124-P1J	24V, 0~2.50A	±3%	120mV	88%
GEM60148-P1J	48V, 0~1.25A	±3%	150mV	90%

Interchangeable AC Plug Specifically for GEM Series

AC Plug Type and Order No.				
AC Plug-AU2	AC Plug-UK2	AC Plug-EU2	AC Plug-US2	AC Plug-MIX2
Australian Type	U.K. Type	European Type	U.S. Type	Mixed Four Type

► The main body unit and AC plug should be ordered separately. The main body needs to be used along with any one of the AC plug.



■ Features

- Slim and 1U profile
- Universal AC input / Full range
- Fanless design
- Flexible output channels with maximum 4 outputs
- 24/48Vdc master output channel models
- 5V/12V/15V/24V DC-DC modules configurable
- No minimum load required
- Protections: Short circuit / Overload / Over voltage / Over temperature
- -30 ~ +70°C wide operating temperature
- LED to indicate power status
- 3 years warranty

■ General Specification (Please refer to www.meanwell.com for detail spec.)



Model No.	UMP-400
AC input voltage range	90~264VAC; 127~370VDC
DC adjustment range	24V: 22.8~25.2V 48V: 45.6~50.4V
Overload protection	105~135% rated output power; CH1/V1, constant current limiting protection; CH2/V2, CH3/V3, CH4/V4, Hiccup mode protection
Over voltage protection	24V: 26.4~31.2V; 48V: 52.8~62.4V; shut down O/P voltage, re-power on to recover
Over temperature protection	Shut down O/P voltage, re-power on to recover
Withstand voltage	I/P-O/P: 4KVAC; I/P-FG: 2KVAC; O/P-FG: 1.5KVAC
Working temperature	-30~+70°C (refer to de-rating curve)
Safety standards	EAC TP TC 004, UL62368-1, Dekra seal BS EN/EN62368-1 approved; Design refer to ANSI/AAMI ES60601-1, TUV BS EN/EN60601-1, IEC60601-1 (3 rd edition)
EMC standards	BS EN/EN55032 Class B, EN61000-3-2,3; EN61000-4-2, 3, 4, 6, 8, 11; EN-61000-6-2; EAC TP TC 020; Design refer to EN55011, EN60601-1-2
Connection	Terminal block
Dimension (LxWxH)(mm)	250 x 89 x 37

■ Order Information

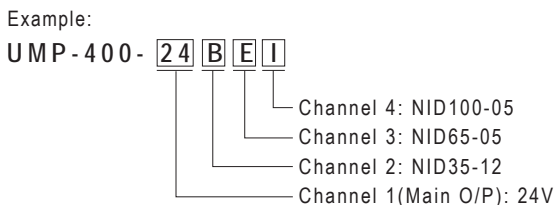
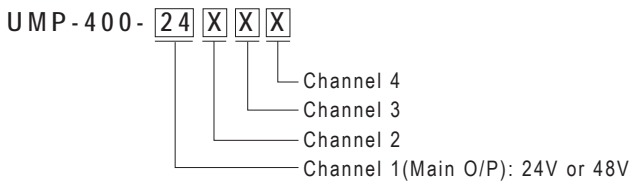

■ 400W UMP-400

Model No.	Output	Effi.
UMP-400-24	24V, 0~16.7A	88.5%*
UMP-400-48	48V, 0~8.3A	88.5%*

*PSU at full load with each type of NID35/65/100 modules at nominal voltage

DC-DC O/P Module	Photo	O/P Voltage	O/P Current
A	NID35-05	5V	3.5A
B	NID35-12	12V	2.9A
C	NID35-15	15V	2.4A
D	NID35-24	24V	1.5A
E	NID65-05	5V	6.5A
F	NID65-12	12V	4.9A
G	NID65-15	15V	4.3A
H	NID65-24	24V	2.7A
I	NID100-05	5V	8.0A
J	NID100-12	12V	6.0A
K	NID100-15	15V	5.2A
L	NID100-24	24V	3.4A
M	NID35-05	-5V	3.5A
N	NID35-12	-12V	2.9A
O	NID35-15	-15V	2.4A
P	NID65-05	-5V	6.5A
Q	NID65-12	-12V	4.9A
R	NID65-15	-15V	4.3A
S	NID100-05	-5V	8.0A
T	NID100-12	-12V	6.0A
U	NID100-15	-15V	5.2A



Description

NMP family is a 1U low profile modular power (configurable type power supply). This family comprises two power wattage for the line-up, 650W and 1200W, and the output modules deliver up to 240W with adjust options for the major working voltages used in industry 5V, 12V, 24V, 48V. NMP family complies with two categories of safety approvals, the medical and ITE standard, offering the best flexibility for various types of applications.

Features

- Medical (2x MOPP)/ITE safety approval
- Suitable for BF application with appropriate system consideration (Touch current <100µA/264VAC)
- 1U low profile
- Universal AC input / Full range
- Output voltage and current programmable
- Built-in parallel function / Output programmable / Globalenable / Remote local ON-OFF / Auxiliary DC output / Over temperature alarm / DC OK
- Cooling by thermostatically controlled fan with fan alarm function
- Protections: Short circuit / Overload / Over voltage / Over temperature for all output modules
- 5 years warranty

General Specification (Please refer to www.meanwell.com for detail spec.)



Model No.	NMP650	NMP1K2
AC input voltage range	90~264VAC ; 120~370VDC	
Power Factor	PF >0.95/230VAC, PF > 0.98/115VAC at full load	
AC inrush current (max.)	Cold start, 40A at 230VAC, 25A at 115VAC	
Max output power	650W	1200W
Efficiency (typical)	91%, full case load with H / K module at nominal 24V / 48V only	
	88.5%, full case load with each type of module at nominal voltage	
Over temperature protection	Output shutdown, auto-recovery	
Withstand voltage	I/P-O/P: 4kVAC, I/P-FG: 2kVAC, O/P-FG: 0.5kVAC	
Working temperature	-30~+50°C@100%, -30~+70°C @ 60% load at 230VAC	
Safety standards	ANSI/AAMI ES60601-1, TUV BS EN/EN60601-1, IEC 60601-1 (3 rd edition), EAC TP TC 004 approved; IEC/UL62368-1, TUV BS EN/EN62368-1 approved	
EMC standards	BS EN/EN55011, EN55032 Class B, EN61000-3-2,-3, EN61000-4-2,3,4,5,6,8,11, EN60601-1-2, EN55024 heavy industry level, criteria A	
Connection	Input side: 3P/9.5mm pitch terminal block &HRS DF11-10DP-2DS	
Dimension (LxWxH)(mm)	250x 89x 41	250x 127x 41

NMS-240: 1-SLOT isolated single output (240W max.)

Item Code	Output	Vdc adj.	Tol.	R&N.	Max.
C	5V, 0~36A	3~6V	±2%	100mV	180W
E	12V, 0~20A	6~15V	±1%	150mV	240W
H	24V, 0~10A	15~30V	±1%	150mV	240W
K	48V, 0~5A	30~55V	±1%	250mV	240W

NMD-240: 1-SLOT isolated dual output (240W max.)

Item Code	Output	Vdc adj.	Tol.	R&N.	Max.
D	30V, 0~5A	3~30V	±2%	250mV	240W
	30V, 0~5A	3~30V	±2%	250mV	240W

Parallel Connection Accessory	
FAP-009 (For NMS-240, 2 units)	
FAP-010 (For NMS-240, 3 units)	
NMS-240-P2/P3/P4/P5/P6 (to parallel NMS-240 in 2/3/4/5/6 modules)	
Series Connection Accessory	
FAS-005 (For 1-slot modules: NMS-240)	
Blank Plate Accessory	
Blank-NMS240	

Output Configuration Guide

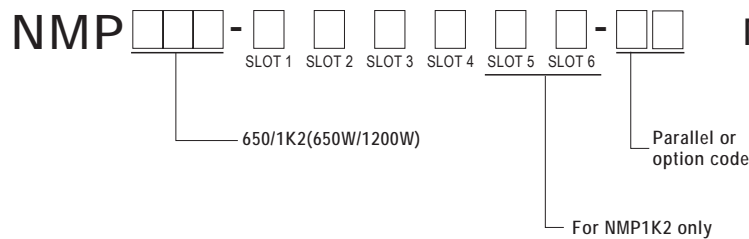

Example:

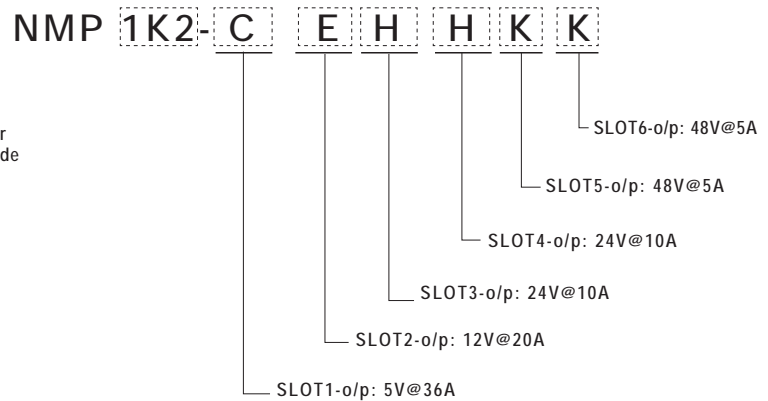

UMP, NMP and MP Series

Difference Series	Wattage	Slots	Output Mod	Safety	Dimension (LxWxH)	Warranty
UMP	400W	4 channels	NID-35/65/100	62368-1	250x 89x 37mm	3 years
NMP	650W 1200W	4 slots 6 slots	NMS-240 NMD-240	62368-1+60601-1	250x 89x 41mm 250x127x 41mm	5 years
MP	450W 600W 1000W	5 slots 5 slots 7 slots	MS-75 MS-150 MS-210 MS-300 MS-360 MD-100	62368-1	254x 127x 63.5mm 278x127x 63.5mm 278x 117.8x 63.5mm	3 years

Modular Series 450W/650W/1000W Configurable Power



MP450 (450W, 5 SLOT)

MP650 (650W, 5 SLOT)

MP1K0 (1000W, 7 SLOT)

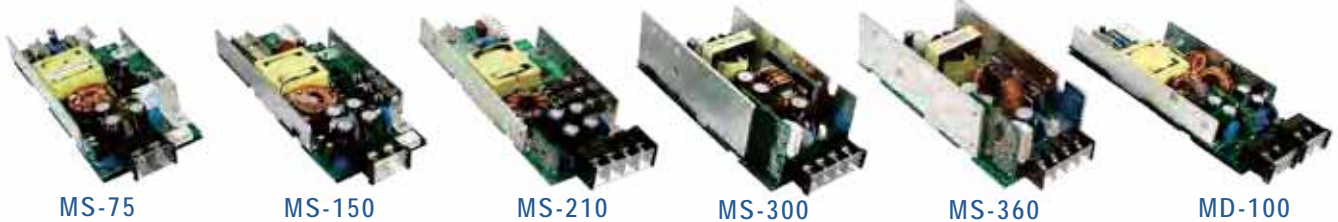

MS-75

MS-150

MS-210

MS-300

MS-360

MD-100

Description

Modular series are switching power supplies with modular design that consist of two stages: front-end PFC and output modules. With the power factor correction, the line input is rectified into high DC voltage (around 390VDC) by the front-end PFC stage, and then the DC output modules will transfer the operating voltage into all kinds of DC output voltages from 1.6V~53V. Right now we offer 75W, 150W, 210W, 300W, 360W single output modules and 100W dual output modules to fulfill all kinds of applications up to 14 isolated outputs.

There are millions of combinations available for the Modular Series. Users can configure the DC outputs and get the fastest solution for their own power requirement with safety and EMC certificates. No NRE / safety application charges and long period of waiting for certificates! Providing standard products as usual, MEAN WELL offers you a revolutionary standard power solution that fulfills your custom-made request!

Output Configuration Guide

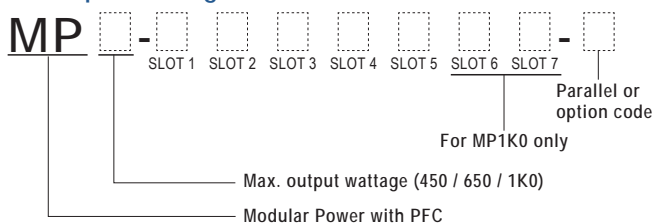

Example:

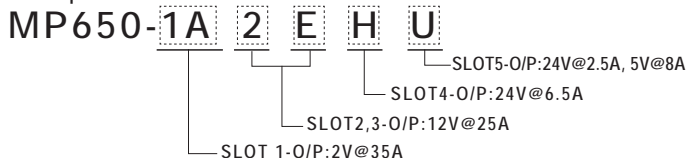

Features

- Millions of output configuration is available
- Universal AC input / Full range
- Built-in active PFC compliance to EN61000-3-2
- Built-in constant current limiting circuit for single output modules
- Remote control on each output module
- Remote sense on each single output module (MS-75 / 150 / 210 / 300 / 360)
- Short circuit / Overload / Over voltage protections for all modules
- Parallel function for MS-210 (up to 5 units), MS-300/360 (up to 3 units)
- Margining control function (MS-210 / 360)
- Cooling by built-in DC fan with fan alarm function
- Additional 12V/0.1A auxiliary output for remote control
- 3 years warranty

General Specification (Please refer to www.meanwell.com for detail spec.)



Model No.	MP450	MP650	MP1K0
AC input voltage range	85~264VAC or 120~370VDC		
Power Factor	PF >0.95 / 230VAC, PF > 0.98 / 115VAC at full load		
AC inrush current (max.)	Cold start, 40A at 230VAC	Cold start, 50A at 230VAC	Cold start, 40A at 230VAC
Max output voltage	450W	650W	1000W
Efficiency (typical)	82.5%	84%	84%
Over temperature protection	Output shutdown, auto-recovery		
Fan alarm	Output shutdown when fan malfunctions		
Withstand voltage	I/P-O/P: 3kVAC, I/P-FG: 2kVAC, O/P-FG: 0.5kVAC, 1 minute		
Working temperature	-20~+50°C@100%, +70°C @ 50% load		
Safety standards	UL62368-1, TUV BS EN/EN62368-1, EAC TP TC 004 approved		
EMC standards	BS EN/EN55032 class B, EN61000-3-2,3, EN61000-4-2,3,4,5,6,8,11, EN55024 light industry level, criteria A, EAC TP TC 020		
Connection	Input side: 3P/10mm pitch terminal block & JST B3B-XH		
Dimension (LxWxH)(mm)	254x 127x 63.5	278x 127x 63.5	278x 177.8x 63.5

MS-75: 1-SLOT single output (75W max.)

Item Code	Output	★Peak I	Vdc adj.	Tol.	R&N.
L	3.3V, 0~15A	17.3A	2.6~4.0V	±2%	80mV
M	5V, 0~15A	17.3A	4.0~6.0V	±2%	80mV
N	12V, 0~6.3A	7.30A	9.0~13.2V	±1%	150mV
O	15V, 0~5.0A	5.80A	13.2~16.8V	±1%	150mV
P	24V, 0~3.2A	3.70A	20.0~26.4V	±1%	150mV
Q	48V, 0~1.6A	1.80A	40.0~53.0V	±1%	250mV

MS-150: 1-SLOT single output (150W max.)

Item Code	Output	★Peak I	Vdc adj.	Tol.	R&N.
A	2V, 0~25A	30.0A	1.6~2.6V	±3%	50mV
B	3.3V, 0~25A	30.0A	2.6~4.0V	±2%	80mV
C	5V, 0~25A	30.0A	4.0~6.0V	±2%	80mV
D	7.5V, 0~18A	20.7A	6.0~9.0V	±2%	100mV
E	12V, 0~13A	15.0A	9.0~13.2V	±1%	150mV
F	15V, 0~10A	11.5A	13.2~16.8V	±1%	150mV
G	18V, 0~8.5A	9.80A	16.8~20.0V	±1%	150mV
H	24V, 0~6.5A	7.50A	20.0~26.4V	±1%	150mV
I	27V, 0~5.8A	6.70A	25.0~31.0V	±1%	150mV
J	33V, 0~4.7A	5.40A	30.0~40.0V	±1%	250mV
K	48V, 0~3.2A	3.68A	40.0~53.0V	±1%	250mV

MS-210: 1-SLOT parallelable single output (210W max.)

Item Code	Output	★Peak I	Vdc adj.	Tol.	R&N.
1A	2V, 0~35A	38.5A	1.6~2.6V	±3%	50mV
1B	3.3V, 0~35A	38.5A	2.6~4.0V	±2%	80mV
1C	5V, 0~35A	38.5A	4.0~6.0V	±2%	80mV
1D	7.5V, 0~28A	32.2A	6.0~9.0V	±2%	100mV
1E	12V, 0~17.5A	20.1A	9.0~13.2V	±1%	150mV
1F	15V, 0~14A	16.1A	13.2~16.8V	±1%	150mV
1G	18V, 0~11.6A	13.4A	16.8~20.0V	±1%	150mV
1H	24V, 0~8.75A	10.1A	20.0~26.4V	±1%	150mV
1I	27V, 0~7.8A	9.00A	25.0~31.0V	±1%	150mV
1J	33V, 0~6.4A	7.40A	30.0~40.0V	±1%	250mV
1K	48V, 0~4.4A	5.10A	40.0~53.0V	±1%	250mV

MS-300: 2-SLOT parallelable single output (300W max.)

Item Code	Output	★Peak I	Vdc adj.	Tol.	R&N.
2A	2V, 0~50A	57.5A	1.6~2.6V	±3%	80mV
2B	3.3V, 0~50A	57.5A	2.6~4.0V	±2%	80mV
2C	5V, 0~50A	57.5A	4.0~6.0V	±2%	80mV
2D	7.5V, 0~40A	46.0A	6.0~9.0V	±2%	100mV
2E	12V, 0~25A	29.0A	9.0~13.2V	±1%	150mV
2F	15V, 0~20A	23.0A	13.2~16.8V	±1%	150mV
2G	18V, 0~16.7A	19.2A	16.8~20.0V	±1%	150mV
2H	24V, 0~12.5A	14.4A	20.0~26.4V	±1%	150mV
2I	27V, 0~11.2A	12.9A	25.0~31.0V	±1%	200mV
2J	33V, 0~9.1A	10.5A	30.0~40.0V	±1%	250mV
2K	48V, 0~6.3A	7.2A	40.0~53.0V	±1%	300mV

MS-360: 2-SLOT parallelable single output (360W max.)

Item Code	Output	★Peak I	Vdc adj.	Tol.	R&N.
3A	2V, 0~60A	69.0A	1.6~2.6V	±3%	80mV
3B	3.3V, 0~60A	69.0A	2.6~4.0V	±2%	100mV
3C	5V, 0~60A	69.0A	4.0~6.0V	±2%	100mV
3D	7.5V, 0~48A	55.2A	6.0~9.0V	±2%	100mV
3E	12V, 0~30A	34.5A	9.0~13.2V	±1%	150mV
3F	15V, 0~24A	27.6A	13.2~16.8V	±1%	150mV
3G	18V, 0~20A	23.0A	16.8~20.0V	±1%	150mV
3H	24V, 0~15A	17.3A	20.0~26.4V	±1%	150mV
3I	27V, 0~13.4A	15.5A	25.0~31.0V	±1%	200mV
3J	33V, 0~11A	12.7A	30.0~40.0V	±1%	250mV
3K	48V, 0~7.5A	8.7A	40.0~53.0V	±1%	300mV

MD-100: 1-SLOT isolated dual output (100W max.)

Item Code	Output	Vdc adj.	Tol.	R&N.	Max.
R	5V, 2.0~10A	4.75~5.5V	±3%	100mV	90.0W
	5V, 0.0~8.0A	4.75~5.5V	±3%	100mV	
S	5V, 2.0~10A	4.75~5.5V	±3%	100mV	100.4W
	12V, 0.0~5.8A	11.4~13.2V	±3%	150mV	
T	5V, 2.0~10A	4.75~5.5V	±3%	100mV	101.0W
	15V, 0.0~4.7A	14.2~16.5V	±3%	150mV	
U	24V, 0.5~3.0A	22.8~26.4V	±3%	200mV	100.0W
	5V, 0.0~10A	4.75~5.5V	±3%	100mV	
V	24V, 0.6~3.0A	22.8~26.4V	±2%	240mV	100.8W
	12V, 0.0~4.7A	11.4~13.2V	±3%	120mV	
W	12V, 1.0~5.0A	11.4~13.2V	±2%	120mV	100.8W
	12V, 0.0~5.8A	11.4~13.2V	±3%	120mV	
X	15V, 1.0~4.7A	14.2~16.5V	±2%	150mV	100.5W
	15V, 0.0~4.7A	14.2~16.5V	±3%	150mV	

★Peak I: 35% duty cycle maximum within every 10 seconds. Average output power should not exceed the rated power.

Parallel Connection Accessory

FAP-001 (For MS-300, 2 units)	
FAP-002 (For MS-300, 3 units)	
FAP-003 (For MS-210, 2 units)	
FAP-004 (For MS-210, 3 units)	
FAP-005 (For MS-210, 4 units)	
FAP-006 (For MS-210, 5 units)	
FAP-007 (For MS-360, 2 units)	
FAP-008 (For MS-360, 3 units)	

Series Connection Accessory

FAS-001 (For 1-slot modules: MS-75/150, MD-100)	
FAS-002 (For 2-slot modules: MS-300)	
FAS-003 (For 1-slot modules: MS-210)	
FAS-004 (For 2-slot modules: MS-360)	

▶ Please use MP450-CNPOQ, MP650-1A2EHU, MP1K0-2C2CEKL-1.....etc. as the order code. For more detail information about technical issues, please refer to the user manual.

▶ Please refer to the user manual for more detail information about parallel connection and the parallel codes. About series connection, please contact us or your local MEAN WELL distributor for more details.

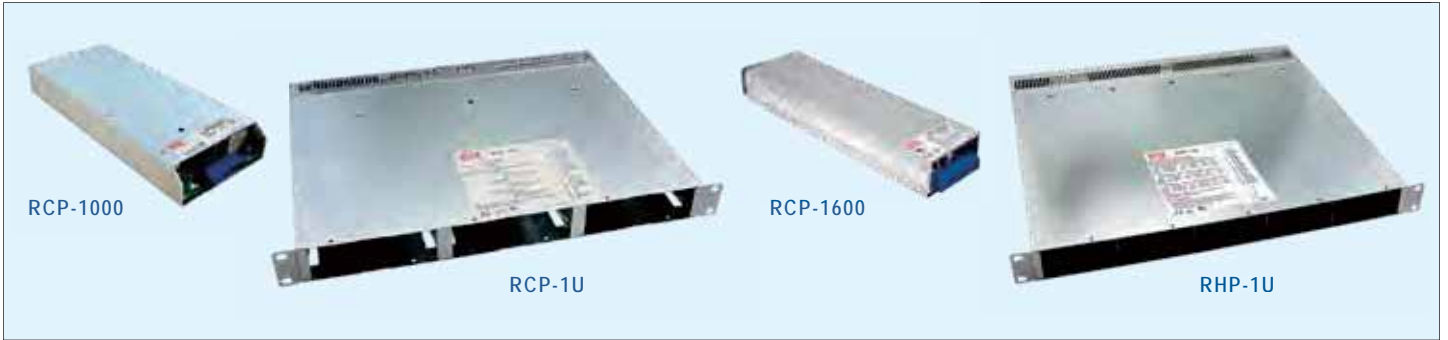

Features

- Universal AC input / Full range
- Built-in active PFC function
- Built-in auxiliary power
- Protections: Short circuit / Overload / Over voltage / Over temperature
- Forced air cooling by built-in DC fan
- High power density up to 25W/inch³
- 1U low profile (41mm height)
- Output voltage programmable; Constant current level I_{cc} programmable
- Active current sharing up to 3 units, 3 racks max. can be operated in parallel (up to 8 units for RCP-1000, up to 15 units for RCP-1600)
- Built-in remote ON/OFF control
- Built-in remote sense function
- AC OK and DC OK signal output
- Internal OR-ing diode, hot-swap operation
- I²C serial data bus; Built-in PMBus serial communication
- 5 years warranty

General Specification (Please refer to www.meanwell.com for detail spec.)



Order No.	RCP-1000	RCP-1600
AC input voltage range	90~264VAC, 127~370VDC	
AC inrush current (max.)	Cold start, 50A at 230VAC	Cold start, 35A at 230VAC
DC adjustment range	V _o : ±3% by potentiometer, or to 90%~110% of rated output voltage by external resistor	V _o : -1%~+22.5% by potentiometer, or to 40%~125% of rated output voltage by 1~5VDC external control signal I _{cc} : to 20%~100% of rated output current by 1~5VDC external control signal
Overload protection (OLP)	105%~125% constant current limiting, auto-recovery	105%~115% constant current limiting, shut down o/p voltage after 5 sec., re-power on to recover
Over voltage protection	110%~135% shut down o/p voltage, re-power on to recover	130%~155% shut down o/p voltage, re-power on to recover
Withstand voltage	I/P-O/P:3kVAC, I/P-FG:2kVAC, O/P-F/G: 0.7kVDC	I/P-O/P:3kVAC, I/P-FG:2kVAC, O/P-F/G: 1.5kVDC
Working temperature	-20~+60°C (refer to output derating curve)	-30~+70°C (refer to output derating curve)
Safety standards	UL62368-1, TUV BS EN/EN62368-1, EAC TP TC 004 approved	
EMC standards	BS EN/EN55032 class B (Radiation class A for RCP-1600), EN61000-3-2,3, EN61000-4-2,3,4,5,6,8,11, EN61000-6-2 heavy industry level	
Connection	Positronic PCB24W9M400A1	
Dimension (LxWxH)	295x 127x 41mm (483.6x 350.8x 44mm for RCP-1U)	300x 85x 41mm (440x 365x 44mm for RHP-1U)

Order Information

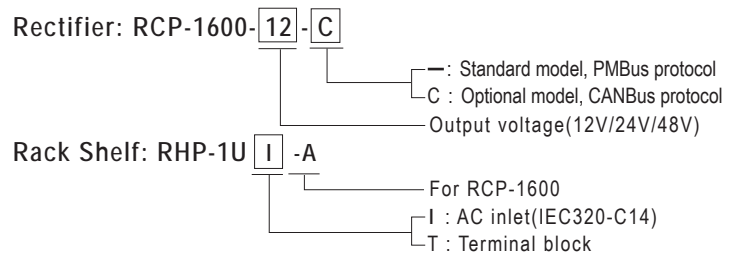
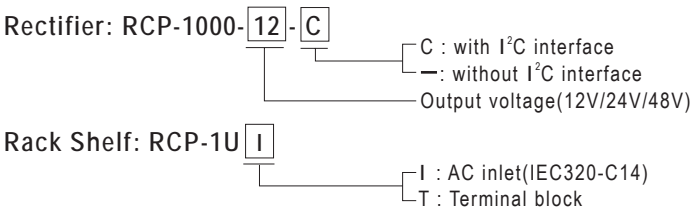

Rectifier — 1000W

Model No.	Output	Tol.	R&N	Effi.
RCP-1000-12	12V, 0~60A	±1%	150mV	81.0%
RCP-1000-24	24V, 0~40A	±1%	200mV	87.0%
RCP-1000-48	48V, 0~21A	±1%	300mV	89.0%

Rectifier — 1600W

Model No.	Output	Tol.	R&N	Effi.
RCP-1600-12	12V, 0~125A	±1%	150mV	88.5%
RCP-1600-24	24V, 0~67A	±1%	200mV	91.0%
RCP-1600-48	48V, 0~33.5A	±1%	300mV	93.0%



Features

- Universal AC input / Full range (Withstand 300VAC surge for 5 seconds)
- Built-in active PFC function
- Built-in 5V/0.3A, 12V/0.8A auxiliary power
- Protections: Short circuit / Overload / Over voltage / Over temperature
- Forced air cooling by built-in DC fan
- High power density 25W/inch³
- 1U low profile (41mm height)
- **Output voltage programmable**
- Active current sharing up to 3 units in one 19" rack, 3 racks max. can be operated in parallel (up to 9 units)
- Built-in remote ON/OFF control
- Built-in remote sense function
- **Internal OR-ing FET, hot-swap operation**
- **Built-in PMBus serial communication**
- AC OK and DC OK signal, fan fail, OTP alarm signal
- **5 years warranty**

General Specification (Please refer to www.meanwell.com for detail spec.)



Order No.	RCP-2000
AC input voltage range	90~264VAC, 127~320VDC
AC inrush current (max.)	Cold start, 50A at 230VAC
DC adjustment range	Vo: -12%~+15% by potentiometer, or to 90%~110% of rated output voltage by 1.5~4.5VDC external control signal
Overload protection	105%~125% constant current limiting, shut down o/p voltage after 5 sec., re-power on to recover
Over voltage protection	120%~145% shut down o/p voltage, re-power on to recover
Setup, rise, hold up time	1500ms, 60ms, 10ms at full load and 230VAC
Withstand voltage	I/P-O/P:3kVAC, I/P-FG:2kVAC, O/P-F/G: 0.7kVDC
Working temperature	-40~+70°C (refer to output derating curve)
Safety standards	UL62368-1, TUV BS EN/EN62368-1, EAC TP TC 004 approved
EMC standards	BS EN/EN55032 class A, EN61000-3-2,3, EN61000-4-2,3,4,5,6,8,11, EN61000-6-2 heavy industry level
Connection	Positronic PCIM34W13M400A1
Dimension (LxWxH)	295x 127x 41mm (483.6x 350.8x 44mm for RKP-1U)

♦ Rectifier — 2000W

Model No.	Output	Tol.	R&N	Effi.
RCP-2000-12	12V, 0~100A	±2%	150mV	86.0%
RCP-2000-24	24V, 0~80A	±1%	200mV	90.5%
RCP-2000-48	48V, 0~42A	±1%	300mV	92.0%

■ Order Information for RCP-2000 and RKP-1U

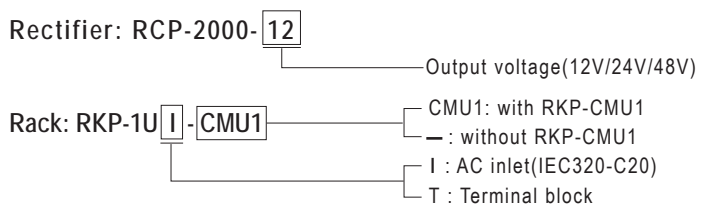

Control and Monitor Unit for RCP-2000



RKP-CMU1



147.5x 127x 41 mm

RKP-1U□-CMU1



483.6x 350.8x 44 mm

- 1U low profile, rack mountable
- Control and monitor up to 9 RCP-2000 units
- Front panel LCD and buttons for on-site service without PC
- Alarm/event log with time and date
- Easy wire connections on rear side
- Windows-based PC communication software
- USB, RS-232 or Ethernet interface for PC connection locally or remote monitoring and control via GSM modem
- 4 user programmable relay outputs for traditional remote or warning
- **5 years warranty**

- DC input voltage range 12~15VDC
- DC input current 1A at 12VDC, 0.8A at 15VDC
- Output relay contact 4 user programmable relay
- Working temperature -25~+70°C (refer to output derating curve)
- Safety standards UL62368-1, TUV BS EN/EN62368-1, EAC TP TC 004 approved for RKP-1U□-CMU1
- Withstand voltage I/P-O/P:3kVAC, I/P-FG:2kVAC, O/P-FG:0.7kVDC for RKP-1U□-CMU1; O/P-FG:0.7kVDC for RKP-CMU1
- Isolation resistance I/P-O/P, I/P-FG, O/P-FG: 100M Ohms/500VDC for RKP-1U□-CMU1; O/P-FG:100M Ohms/500VDC for RKP-CMU1
- EMC standards BS EN/EN55032 class B, EN61000-3-2,3, EN61000-4-2,3,4,5,6,8,11, EN61000-6-1 light industry level

Model No.	Application
RKP-CMU1	Control and monitor RCP-2000 series (single unit of RKP-CMU1)
RKP-1U□-CMU1	Control and monitor RCP-2000 series (19" rack with RKP-CMU1)

3200W Programmable Power Supply

- Universal AC Input/ Full Range
- High efficiency up to 94.5%
- PV (Programmable voltage) PC (Programmable constant current) functions
- Built-in OR-ing MOSFET, support hot swap/plug
- Active current sharing, up to **12.8W per rack**, maximum of 128KW in total
- I²C interface, support PMBus protocol (CANBus optional)
- Protections: Short circuit / Overload / Over voltage / Over temperature
- Optional conformal coating
- 5 years warranty



3U Rack Mountable Control and Monitor Unit

- 2 models, 3U 19-inch rackmount and standalone configurations
- 7" TFT LCD Panel and buttons for easy on-site operation
- Ethernet port for **on-site connection** or **remote access** to enable on-line monitor and control over system
- Support **PMBus**, **CANbus**, **RS-485**, and **RS-232** as default communication interfaces
- Four user programmable relay outputs for conventional remote monitoring or warning
- **Web-based** monitor/control UI provided
- 5 years warranty

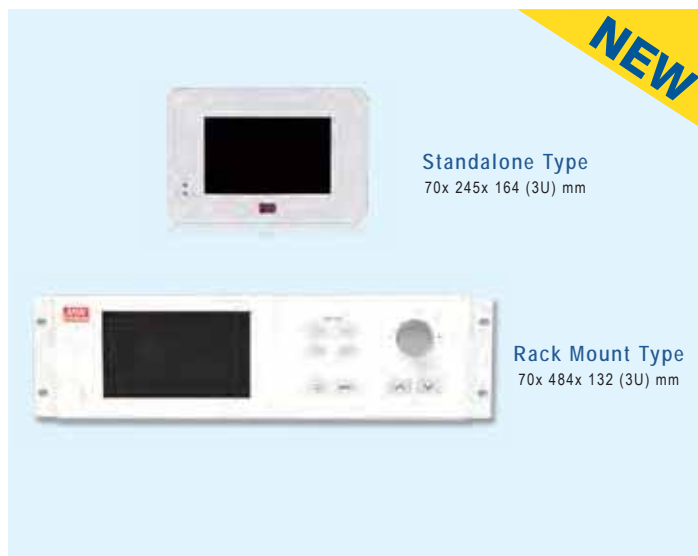

Order Information

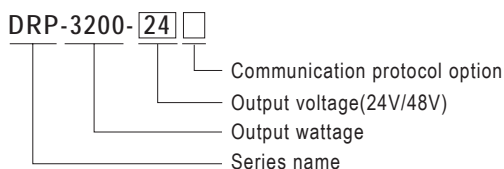

Features

- AC input voltage range 90~264VAC; 127~370VDC
- AC inrush current (max.)..... Cold start, 17A/230VAC
- DC adjustment range 24V: 23.5-30V; 48V: 47.5-58.8V
- Over voltage protection 24V: 31.5-37.5V; 48V: 63-75V
- Withstand voltage I/P-O/P: 3KVAC; I/P-FG: 2KVAC; O/P-FG: 1.5KVAC (0.5KVAC for 24V)
- Working temperature -30~+70°C (refer to output derating curve)
- Safety standards UL62368-1, TUV BS EN/EN62368-1, EAC TP TC 004 approved
- EMC standards Compliance with BS EN/EN55032 (CISPR32) Conduction Class B, Radiation Class A; EN61000-3-2, -3-3, EAC TP TC 020, EN61000-4-2,3,4,5,6,8,11, EN61000-6-2
- Connection Positronic PCIM34W13F400A1

Model No.	Output	Efficiency
DRP-3200-24	24V, 0~133A	93.5%
DRP-3200-48	48V, 0~67A	94.5%

Description

CMU2 is a fully digitalized master controller that can execute tasks of monitoring and controlling over power system. CMU2 implements a 7" LCD touch panel to achieve intuitive operation, and developed a brand new web monitoring page for faster and smarter management. CMU2 not only being used to monitor the operating parameters and data of PSUs such as output voltage, output current, internal temperature, fan rpm, series number and firmware version, but also can be used to adjust output voltage and current. In addition, it can remotely control single PSU or entire power system through LAN or internet.

Order Information

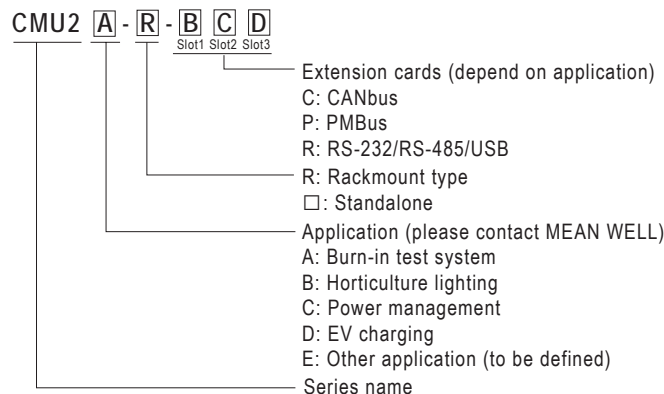

30W Green Adaptor with Charging Function

- Universal AC input / Full range
- Class II power (without earth pin)
- **No load power consumption <1W**
- Constant current and voltage (CC, CV mode)
- High reliability
- Suitable for high surge current equipment
- Protections: Short circuit / Overload / Over voltage / Over temp.
- 2 color LED indicator for charging status
- Fully enclosed plastic case
- 2 years warranty



AC input voltage range 90~264VAC; 127~370VDC
 Overload protection 90%~110% constant current mode and over 300% pulsing mode
 Over voltage protection 110%~135% rated output voltage
 Withstand voltage I/P-O/P: 3kVAC, 1minute
 Working temperature 0~+50°C (refer to output derating curve)
 Safety standards .. UL62368-1, CSA 22.2, TUV BS EN/EN62368-1, EAC TP TC 004 approved
 EMC standards BS EN/EN55014-1, EN61000-3-2,3, EN61000-4-2,3,4,5,6,11, EAC TP TC 020
 Length of output cable 120cm of UL1185, 16AWG for 4.2~8.4V
 180cm of UL1185, 18AWG for 14.3~28.6V
 Standard DC plug P1J: 2.1øx5.5øx11mm / C+, tuning fork type

Order No.	Output	R&N	Effi.
GC30□-0P1J	4.2V, 0~4.00A	50mV	55%
GC30□-1P1J	5.6V, 0~3.99A	50mV	70%
GC30□-11P1J	7.2V, 0~3.00A	80mV	74%
GC30□-2P1J	8.4V, 0~3.00A	80mV	76%
GC30□-4P1J	14.3V, 0~2.09A	100mV	78%
GC30□-5P1J	16.8V, 0~1.60A	100mV	78%
GC30□-6P1J	28.6V, 0~1.04A	150mV	80%

□ = B / U / E ; B: IEC320-C8, U: American 2P, E: European 2P

120W Green Adaptor with Charging Function

- Universal AC input / Full range
- Built-in active PFC function
- **No load power consumption <0.5W**
- High efficiency up to 91%
- 2 stage charging characteristic
- Cooling by free air convection
- 3 pole AC inlet IEC320-C14
- Class I power (with earth pin)
- Protections: Short circuit / Overload / Over voltage / Over temp.
- Fully enclosed plastic case
- 2 color LED indicator for charging status
- 2 years warranty

AC input voltage range 85~264VAC; 120~370VDC
 Overload protection 90~110% constant current, auto-recovery
 Over voltage protection 105%~135% shut down O/P voltage, re-power on to recover
 Withstand voltage I/P-O/P: 3kVAC
 Working temperature -30~+70°C (refer to derating curve)
 Safety standards UL1012 (GC120Axx-AD1 only), BS EN/EN62368-1, J62368-1 approved, EAC TPTC004
 EMC standards BS EN/EN55032 class B, FCC part 15 class B, EAC TPTC020, EN61000-3-2,3, EN61000-4-2,3,4,5,6,8,11
 Length of output cable 120cm of UL2464, 18AWGx 4C
 Standard DC plug Power DIN 4P with lock type (R7B)

Model No.	Output	Effi.
GC120A12-□	13.6V, 7.5A	86.5%
GC120A24-□	27.2V, 4.42A	90.0%
GC120A48-□	54.4V, 2.21A	91.0%

□ = R7B / AD1 ; R7B= 4 pin power din, AD1= Anderson connector

160W Green Adaptor with Charging Function



- Universal AC input / Full range
- Built-in active PFC function
- **No load power consumption <1W**
- High efficiency up to 94%
- 2 stage charging characteristic
- Cooling by free air convection
- 3 pole AC inlet IEC320-C14
- Class I power (with earth pin)
- Protections: Short circuit / Overload / Over voltage / Over temp.
- Fully enclosed plastic case
- 2 color LED indicator for charging status
- 2 years warranty

AC input voltage range 85~264VAC; 120~370VDC
 Overload protection 90%~110% constant current, auto-recovery
 Over voltage protection 105%~135% rated output voltage, re-power on to recover
 Withstand voltage I/P-O/P: 3kVAC
 Working temperature -30~+70°C (refer to derating curve)
 Safety standards ... UL1012(GC160Axx-AD1 only), BS EN/EN62368-1, EAC TPTC004 approved
 EMC standards BS EN/EN55032 class B, FCC part 15 class B, EN61000-3-2,3, EN61000-4-2,3,4,5,6,8,11, EAC TPTC020
 Length of output cable 120cm of UL2464, 18AWGx 4C
 Standard DC plug Power DIN 4P with lock type (R7B)

Model No.	Output	Effi.
GC160A12-□	13.6V, 10.0A	89.0%
GC160A24-□	27.2V, 5.89A	92.5%
GC160A48-□	54.4V, 2.95A	94.0%

□ = R7B / AD1 ; R7B= 4 pin power din, AD1= Anderson connector

218W & 326W Green Adaptor with Charging Function



- Universal AC input / Full range; 90~264VAC; 127~370VDC
- Built-in active PFC function
- **No load power consumption <1W**
- 2 stage charging characteristic
- Cooling by free air convection
- 3 pole AC inlet IEC320-C14
- Class I power (with earth pin)
- Protections: Short circuit / Overload / Over voltage / Over temperature
- Fully enclosed plastic case
- 2 color LED indicator for charging status
- 2 years warranty

Overload protection 90%~110% constant current, auto-recovery
 Over voltage protection 105%~135% rated output voltage, re-power on to recover
 Withstand voltage I/P-O/P: 3kVAC
 Working temperature -30~+60°C (refer to output derating curve)
 Safety standards GC220: TUV BS EN/EN62368-1, UL1012 (GC220Axx-AD1 only), EAC TPTC004 approved
 GC330: TUV BS EN/EN62368-1, UL62368-1, EAC TPTC004 approved
 EMC standards BS EN/EN55032 class B, FCC part 15 class B, EAC TPTC020, EN61000-3-2,3, EN61000-4-2,3,4,5,6,8,11
 Length of output cable 100cm of UL2464, 16AWGx 4C
 Standard DC plug ... GC220: Power DIN 4P with lock type (R7B)
 GC330: 4P/6.35mm pitch, AMP 1-480702-0 (power supply side); AMP 1-480703-0 (customer side)

GC220 Series

Model No.	Output	Effi.
GC220A12-□	13.6V, 13.5A	89.0%
GC220A24-□	27.2V, 8A	92.5%
GC220A48-□	54.4V, 4A	93.0%

□ = R7B / AD1 ; R7B= 4 pin power din, AD1= Anderson connector

GC330 Series

Model No.	Output	Effi.
GC330A36-C4P	40.8V, 8A	93.5%
GC330A48-C4P	54.4V, 6A	93.5%



ENP-120/180/240/360
(power supply)



ENC-120/180/240/360
(charger)

Features

- Universal AC input / Full range
- Energy efficiency **Level VI (ENP only)**
- Comply with EISA 2007/DoE, NRCAN, EU ErP and CoC Version 5 for ENP(EISA 2007/DoE, NRCAN, EU ErP for ENP-360)
- Built-in default 3 stage charging curve, **curve programmable with SBP-001(see page97,ENC only)**
- **Fanless design, no noise**
- Protections: Short circuit / Overload (ENP only) / Over voltage / Over temperature
- 3 years warranty

General Specification (Please refer to www.meanwell.com for detail spec.)

Order No.	ENP/ENC-120	ENP/ENC-180	ENP/ENC-240	ENP/ENC-360
AC input voltage range	90~264VAC; 127 ~ 370VDC			
AC inrush current (max.)	Cold start, 65A at 230VAC	Cold start, 70A at 230VAC	Cold start, 75A at 230VAC	Cold start, 60A at 230VAC
DC adjustment range	12V: 11.5~15V, 24V: 23.5~30V, 48V: 47.5~58.8V / NA for ENC			
Protection	Overload	110~125% constant current limiting, auto-recovery / NA for ENC		
	Over voltage	110~130% shut down and latch off o/p voltage, re-power on to recover		
	Over temp.	Shut down o/p voltage, auto-recovery after temperature goes down		
Withstand voltage	I/P-O/P:3KVAC, I/P-FG:2KVAC, O/P-FG:0.5KVAC			
Working temperature	-30~+70°C (refer to output derating curve)			
Safety standards	UL62368-1, EAC TP TC 004; BSMI CNS14336-1(ENC series only);J62368-1(ENC-360-12 only)approved			
EMC standards	BS EN/EN55032 class B, EN61000-3-2,3, EN61000-4-2,3,4,5,6,8,11;FCC part 15			
Dimension (LxWxH)(mm)	192x 178x 45.5			

ENP-120

Model No.	Output	Tol.	R&N	Effi.
ENP-120-12	13.8V, 0~8.7A	±1%	150mV	89.5%
ENP-120-24	27.6V, 0~4.3A	±1%	150mV	91%
ENP-120-48	55.2V, 0~2.2A	±1%	350mV	91.5%

ENC-120

Model No.	Output	Effi.
ENC-120-12	14.4V, 0~8A	89%
ENC-120-24	28.8V, 0~4A	90%
ENC-120-48	57.6V, 0~2A	90.5%

ENP-180

Model No.	Output	Tol.	R&N	Effi.
ENP-180-12	13.8V, 0~13A	±1%	150mV	91%
ENP-180-24	27.6V, 0~6.5A	±1%	150mV	93.5%
ENP-180-48	55.2V, 0~3.3A	±1%	350mV	94%

ENC-180

Model No.	Output	Effi.
ENC-180-12	14.4V, 0~12A	91%
ENC-180-24	28.8V, 0~6A	92%
ENC-180-48	57.6V, 0~3A	93%

ENP-240

Model No.	Output	Tol.	R&N	Effi.
ENP-240-12	13.8V, 0~17.4A	±1%	150mV	91%
ENP-240-24	27.6V, 0~8.7A	±1%	150mV	93.5%
ENP-240-48	55.2V, 0~4.4A	±1%	350mV	94%

ENC-240

Model No.	Output	Effi.
ENC-240-12	14.4V, 0~16A	91%
ENC-240-24	28.8V, 0~8A	92%
ENC-240-48	57.6V, 0~4A	93%

ENP-360

Model No.	Output	Tol.	R&N	Effi.
ENP-360-12	13.8V, 0~26A	±1%	150mV	91%
ENP-360-24	27.6V, 0~13A	±1%	150mV	93%
ENP-360-48	55.2V, 0~6.5A	±1%	350mV	94%

ENC-360

Model No.	Output	Effi.
ENC-360-12	14.4V, 0~24A	91%
ENC-360-24	28.8V, 0~12A	93%
ENC-360-48	57.6V, 0~6A	94%



Features

- Stationary charger for lead-acid batteries
- AC input range selectable by switch
- Protections: Short circuit / Overload / Over voltage / Over temperature
- 3 poles AC inlet with fuse holder
- 2 color LED loading indicator
- Open frame models available (without safety approvals)
- 2 years warranty

The performance of NPB-120 is better than PA/PB-120. It is highly recommended to use NPB-120 for all new project

General Specification (Please refer to www.meanwell.com for detail spec.)



Model No.	PA/B-120
AC input voltage range	88~132VAC/ 176~264VAC selectable by switch
AC inrush current (max.)	Cold start, 50A at 230VAC
Overload protection	90%~110% constant current limiting ,auto-recovery
Over voltage protection	108%~127% hiccup mode, auto-recovery
Setup, rise, hold up time	1000ms, 50ms, 16ms at full load and 230VAC
Withstand voltage	I/P-O/P: 3kVAC, I/P-FG: 2kVAC, O/P-FG: 0.5kVAC
Working temperature	-10~+45°C (refer to output derating curve)
Safety standards	UL60950-1, BS EN/EN60335-1, EN60335-2-29(except for 55.2V), EAC TP TC 004 approved
EMC standards	BS EN/EN55032 class B, EN61000-4-2,3,4,5,6,8,11, EN61000-3-2,3, EAC TP TC 020
Dimension (LxWxH)(mm)	Case Type: 180x 96x 49; PCB Type: 144x 90x 33

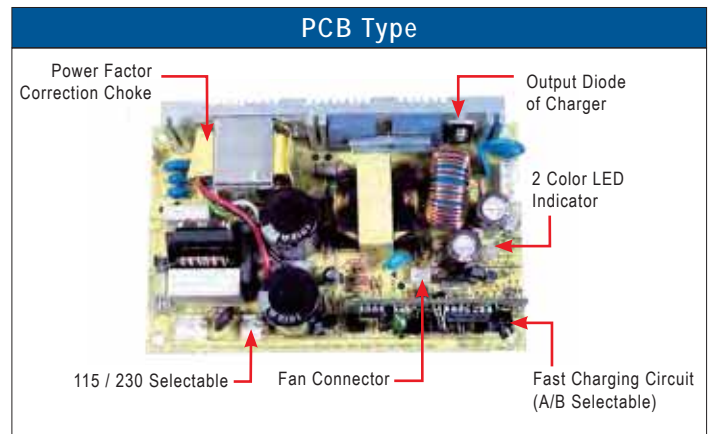
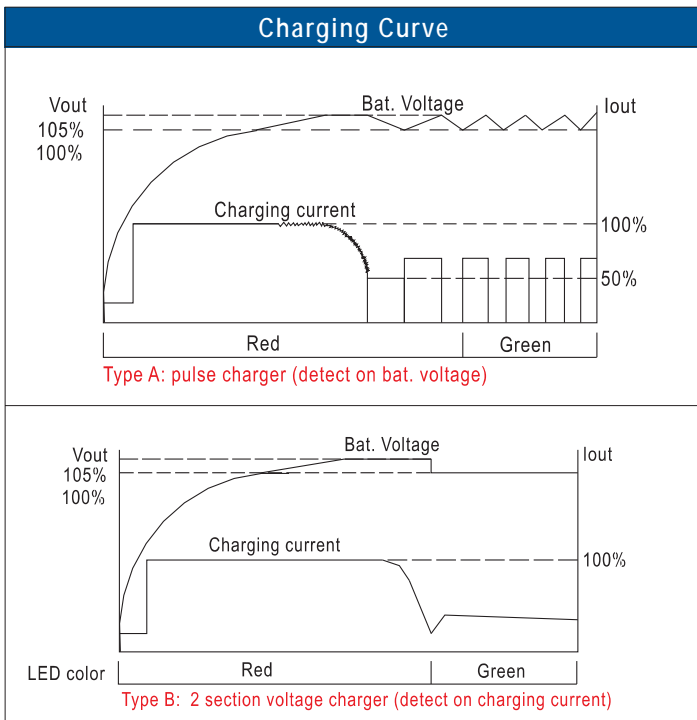

PA-120/PB-120

Model No.	Output	Tol.	R&N	Effi.
P□-120N-13Δ	13.8V, 0~7.2A	±3~±8.5%	150mV	73%
P□-120N-27Δ	27.6V, 0~4.3A	±1~±8.0%	200mV	79%
P□-120N-54Δ	55.2V, 0~2.2A	±1~±7.5%	250mV	79%

□= A/B; Δ= P/C, P:Open Frame, C: With case



Features for PB-300/360

- 3 stage charger for lead-acid batteries and Li-ion batteries
- AC input range selectable by switch
- Passive PFC compliance to EN61000-3-2 class A
- Protections: Reverse polarity / Short circuit / Over voltage / Over temperature
- 2 color LED loading indicator
- Fan ON/OFF control (PB-360 only)
- Fanless design(PB-300), built-in DC fan(PB-360)
- 3 years warranty

Features for PB-600/1000

- 2/3/8 stage smart charger for lead-acid batteries and Li-ion batteries, microprocessor controlled power management
- CANBus potocol (optional for PB-1000)
- Active PFC function
- Battery rescue function
- Protections: Reverse polarity / Short circuit / Over voltage / Over temp.
- Temperature compensation function
- 2-bank charger (PB-1000)
- 3 color LED loading indicator
- Remote ON-OFF control
- Fan ON/OFF control (PB-600)
- 3 years warranty

The size and performance of NPB-360/450/750/1200 are better than PB-300/360/600/1000. It is highly recommended to use NPB-360/450/750/1200 for all new project

General Specification (Please refer to www.meanwell.com for detail spec.)

Order No.	PB-300 □	PB-360 □	PB-600	PB-1000
AC input voltage range	90~132VAC / 180~264VAC selectable by switch		90~264VAC; 127~370VDC	
Over voltage protection	108%~125% rated output voltage		110%~125% rated output voltage	
Withstand voltage	I/P-O/P: 3kVAC, I/P-FG: 2kVAC, O/P-FG: 0.5kVAC (I/P-FG: 1.5kVAC for PB-360)			
Working temperature	-10~+50°C		-20~+60°C (refer to output derating curve)	
Safety standards	CB IEC60335-2-29 (except for 48V), UL62368-1, EAC TP TC 004 approved		TUV BS EN/EN60335-1, EN60335-2-29 (except for 48V), EN62368-1(48V only), UL1012, EAC TP TC 004 approved	UL62368-1, TUV BS EN/EN62368-1, EAC TP TC 004 approved
EMC standards	BS EN/EN55032 class B, EN61000-4-2,3,4,5,6,8,11, EN61000-3-2,3 (except for PB-300/360 non-PFC type), EAC TP TC 020			
Dimension (LxWxH)(mm)	253x 135x 48.5		230x 158x 67	
			300x 184x 70	

PB-300



Model No.	Output (20 min.) / (Continuous at 25°C)	Effi.
PB-300□-12	14.4V, 20.85A / 12.5A	85%
PB-300□-24	28.8V, 10.50A / 6.25A	86%
PB-300□-48	57.6V, 5.3A / 3.20A	88%

□ = P: with PFC; N: non PFC

PB-600



Model No.	Output	Effi.
PB-600-12	14.4V, 0~40.0A	86%
PB-600-24	28.8V, 0~21.0A	87%
PB-600-48	57.6V, 0~10.5A	89%

PB-360



Model No.	Output	Effi.
PB-360□-12	14.4V, 24.3A	85%
PB-360□-24	28.8V, 12.5A	86%
PB-360□-48	57.6V, 6.25A	87%

□ = P: with PFC; N: non PFC

PB-1000



Model No.	Output	Effi.
PB-1000-12	14.4V, 60.0A	85%
PB-1000-24	28.8V, 34.7A	88%
PB-1000-48	57.6V, 17.4A	89%

Built-in Charging Curves for PB-600 and PB-1000

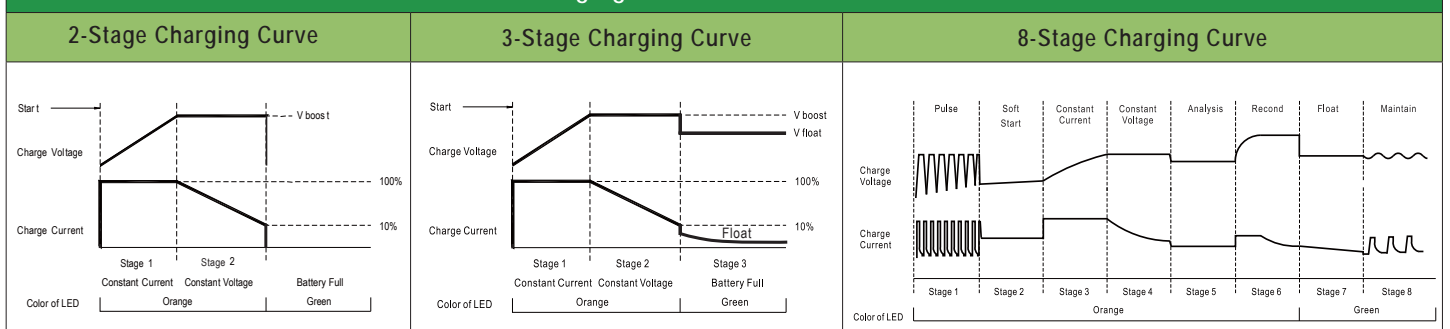

Charger 120~360W High Reliable Wide Output Range Battery Charger



NEW



NPB-120



NPB-240



NPB-360

O/P Connector Type	
XLR	
AD1	
TB	

Features

- Compact size and **wide output range** charger
- Suitable for lead-acid and **li-ion batteries**
- **Fanless design**(NPB-120/240), fan speed control by thermal(NPB-360)
- **Charging voltage/current adjustable** by VR
- **2 or 3 stage selectable** by DIP S.W
- No load power consumption < 0.15W(AC S.W off)
- **-30 ~+70** wide operating temperature
- Protections:
 - Short circuit / Over voltage /Over temperature /
 - Battery reverse polarity protection
- comply with **62368-1+ 60335-1/-2/-29 dual certification**
- Multiple standard output connectors
- 3 years warranty

General Specification (Please refer to www.meanwell.com for detail spec.)



Model No.	NPB-120	NPB-240	NPB-360
AC input voltage range	90~264VAC;127~370VDC		
Charging voltage Adj.range	14.4V:10.5~15.2V,28.8V:21~30.4V,57.6V: 42~60.8V by VR		
Charging current Adj.range	50~100% rated output current by VR		
Protections	DC o/p short	Constant current limiting, charger will shutdown after 5 sec, re-power on to recover	
	Over voltage	105~132% shut down and latch off o/p voltage, re-power on to recover	
	Over temp.	Shut down o/p voltage, recovers automatically after temperature goes down	
	Reverse polarity	By internal fuse open	
Withstand voltage	I/P-O/P: 3kVAC, I/P-FG: 2kVAC, O/P-FG: 0.5kVAC		
Working temperature	-30~+70°C (refer to output derating curve)		
Safety standards	CB IEC62368-1, IEC60335-2-29, DEKRA BS EN/EN62368-1, BS EN/EN60335-1-2-29, UL62368-1, EAC TP TC 004 approved		
EMC standards	BS EN/EN55032 classB, BS EN55014-1, BS EN/EN61000-3-2,3, BS EN/EN61000-4-2,3,4,5,6,8,11, EAC TPTC020		
Dimension (LxWxH)(mm)	180x 96x 49		

120W NPB-120

Model No.	Output	Effi.
NPB-120-12□	14.4V(10.5~15.2V), 6.8A	86.5%
NPB-120-24□	28.8V(21~30.4V), 4.0A	89.0%
NPB-120-48□	57.6V(42~60.8V), 2.0A	90.5%

□ = XLR; AD1;TB

240W NPB-240

Model No.	Output	Effi.
NPB-240-12□	14.4V(10.5~15.2V), 13.5A	88.5%
NPB-240-24□	28.8V(21~30.4V), 8.0A	92.0%
NPB-240-48□	57.6V(42~60.8V), 4.0A	92.5%

□ = XLR; AD1;TB

360W NPB-360

Model No.	Output	Effi.
NPB-360-12□	14.4V(10.5~15.2V), 20A	87.0%
NPB-360-24□	28.8V(21~30.4V), 12A	91.0%
NPB-360-48□	57.6V(42~60.8V), 6A	92.0%

□ = XLR; AD1;TB

Functions

Charging stage Adj	Io Adj	Vo Adj
2 or 3 stage Adj. by DIP S.W	50~100% rated current adjustable by VR	14.4V(10.5~15.2V) 28.8V(21~30.4V) 57.6V(42~60.8V) by VR

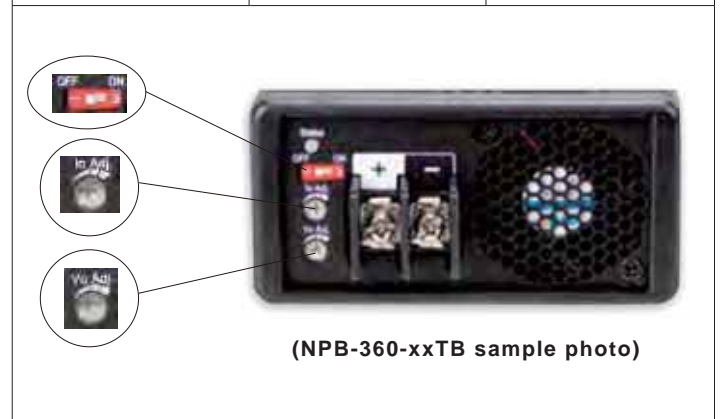



Features

- Intelligent auto ranging with wide charging voltage
- Digital/manual setting for 2/3 stage or charging curve along with SBP-001(see page 97)
- Built-in CANBus interface for control and monitor
- Charging current adjustable 50~100% by VR
- -30 ~+70 wide operating temperature
- Multiple Protections: Short circuit / Over voltage / Over temperature/ Battery under voltage/Battery reverse polarity(No damage)
- Charging OK and battery full signal detect by TTL
- Remote ON-OFF control
- Temperature compensation function to prolong battery life
- Thermal-controlled DC fan
- Suitable for lead-acid (Pb) and li-ion batteries.
- Comply with 62368-1+60335-1/-2-29 dual certification
- Pull handle accessory available (Order NO.: carry handle, sold separately)
- 3 years warranty

General Specification (Please refer to www.meanwell.com for detail spec.)



Model	NPB-450	NPB-750	NPB-1200	NPB-1700
AC input voltage range	90~264VAC; 127 ~ 370VDC			
Charge voltage range	14.4V: 10.5~21V, 28.8V: 21~42V, 57.6V: 42~80V, 72V: 54~100V(72V for NPB-450 only)			
Protections	DC O/P short	Constant current limiting, charger will shut down after 5 sec.,re-power on to recover		
	Over voltage	103~125% shut down and latch off o/p voltage, re-power on to recover		
	Over temp.	Shut down O/P voltage, recovers automatically after temperature goes down		
	Reverse polarity	Protected internal reverse detection, NO damage,re-power on to recover after conduction is removed		
Withstand voltage	I/P-O/P:3KVAC, I/P-FG:2KVAC, O/P-FG:0.5KVAC			
Working temperature	-30~+70°C (refer to output derating curve)			
Safety standards	CB IEC6238-1 and IEC 60335-1/2-29,DEKRA BS EN/EN62368-1 and BS EN/EN60335-1/2-29,UL 62368-1,EAC TP TC 004 approved			
EMC standards	BS EN/EN 55032,BS EN/EN 61000-3-2,3; BS EN/EN 61000-4-2,3,4,5,6,8,11, EAC TP TC 020; EN55014-1(NPB-450/750 only)			
Dimension (LxWxH)(mm)	205x 130x 55	230x 158x 67	250x 158x 67	300x 184x 70

450W NPB-450			1200W NPB-1200		
Model No.	Output	Effi.	Model No.	Output	Effi.
NPB-450-12	14.4V(10.5~21V), 0~25A	92%	NPB-1200-12	14.4V(10.5~21V), 0~70A	91%
NPB-450-24	28.8V(21~42V), 0~13.5A	93%	NPB-1200-24	28.8V(21~42V), 0~36A	92%
NPB-450-48	57.6V(42~80V), 0~6.8A	93%	NPB-1200-48	57.6V(42~80V), 0~18A	93%
NPB-450-72	72V(54~100V), 0~5.5A	93%			

750W NPB-750			1700W NPB-1700		
Model No.	Output	Effi.	Model No.	Output	Effi.
NPB-750-12	14.4V(10.5~21V), 0~43A	92%	NPB-1700-12	14.4V(10.5~21V), 0~85A	91%
NPB-750-24	28.8V(21~42V), 0~22.5A	93%	NPB-1700-24	28.8V(21~42V), 0~50A	92%
NPB-750-48	57.6V(42~80V), 0~11.3A	93%	NPB-1700-48	57.6V(42~80V), 0~25A	93%

Functions

Io Adj. by VR	
	Can adjustable 50~100% output current by VR

2 or 3-stage & charging curve selectable by DIP S.W											
1 2 3 OFF ON	1 2 3 OFF ON	3	Description	Vboost				Vfloat			
				12V	24V	48V	72V	12V	24V	48V	72V
				OFF: 3 stage (Default)	OFF	OFF	Default, programmable	14.4V	28.8V	57.6V	72V
ON: 2 stage	ON	OFF	Pre-defined, Gel battery	14.0V	28.0V	56.0V	70V	13.6V	27.2V	54.4V	68V
	OFF	ON	Pre-defined, flooded battery	14.2V	28.4V	56.8V	71V	13.4V	26.8V	53.6V	67V
ON	ON	ON	Pre-defined, AGM battery, LiFe04	14.6V	29.2V	58.4V	73V	14.0V	28.0V	56.0V	70V

Smart programmable with SBP-001 & Digital communication														
		1	2	3	4	5	6	7	8	9,10	11	12	13	14
2	1	CAN Bus address A1	CAN Bus address A0	Prog +3.3V	CAN Bus address GND	BAT OK	Charger OK	RC ON/OFF	+12Vaux	GND-AUX	CANH	CANL	NTC+	NTC-



Features

- **Mult-function-battery charger or power supply** operation mode selectable
- **Output voltage and current adjustable** via VR
- 3-stage charging curve for charging mode
- **-30~70** wide operating temperature
- Multiple Protections: Short circuit / Over voltage / Over temperature
- Remote ON-OFF control
- Thermal controlled DC fan
- Suitable for lead-acid(Pb)batteries
- Comply with **62368-1+60335-1/-2-29 dual certification**
- **Pull handle** accessory available (Order NO.:carry handle,sold sparately)
- 3 years warranty

General Specification (Please refer to www.meanwell.com for detail spec.)



Model	NPP-450	NPP-750	NPP-1200	NPP-1700
AC input voltage range	90~264VAC; 127 ~ 370VDC			
Charge voltage range	14.4V: 10.5~21V , 28.8V: 21~42V , 57.6V: 42~80V , 72V: 54~100V (72V for NPP-450 only)			
Protections	DC O/P short	Constant current limiting, charger will shut down after 5 sec.,re-power on to recover		
	Over voltage	103~125% shut down and latch off o/p voltage, re-power on to recover		
	Over temp	Shut down O/P voltage, recovers automatically after temperature goes down		
Withstand voltage	I/P-O/P:3KVAC, I/P-FG:2KVAC, O/P-FG:0.5KVAC			
Working temperature	-30~+70°C (refer to output derating curve)			
Safety standards	CB IEC6238-1 and IEC 60335-1/2-29 ,DEKRA BS EN/EN62368-1 and BS EN/EN60335-1/2-29 ,UL 62368-1,EAC TP TC 004 approved			
EMC standards	BS EN/EN 55032,BS EN/EN 61000-3-2,3; BS EN/EN 61000-4-2,3,4,5,6,8,11 ,EAC TP TC 020;EN55014-1(NPP-450/750 only)			
Dimension (LxWxH)(mm)	205x 130x 55	230x 158x 67	250x 158x 67	300x 184x 70

450W NPP-450

Model No.	Output	Effi.
NPP-450-12	14.4V(10.5~21V), 12.5~25A	92%
NPP-450-24	28.8V(21~42V), 6.75~13.5A	93%
NPP-450-48	57.6V(42~80V), 3.4~6.8A	93%
NPP-450-72	72V(54~100V), 2.75~5.5A	93%

1200W NPP-1200

Model No.	Output	Effi.
NPP-1200-12	14.4V(10.5~21V),35~70A	91%
NPP-1200-24	28.8V(21~42V), 18~36A	92%
NPP-1200-48	57.6V(42~80V), 9~18A	93%

750W NPP-750

Model No.	Output	Effi.
NPP-750-12	14.4V(10.5~21V),21.5~43A	92%
NPP-750-24	28.8V(21~42V), 11.25~22.5A	93%
NPP-750-48	57.6V(42~80V), 5.65~11.3A	93%

1700W NPP-1700

Model No.	Output	Effi.
NPP-1700-12	14.4V(10.5~21V), 42.5~85A	91%
NPP-1700-24	28.8V(21~42V), 25~50A	92%
NPP-1700-48	57.6V(42~80V), 12.5~2.5A	93%

NPB vs. NPP Series

Functions Series	Mounting style	Product level	2 or 3 stage	Vo Adj.	Io Adj.	Built-in CAN Bus	O/P connector	Built-in Fan	Dimension (LxWxH,mm)
NPB-120 NPB-240 NPB-360	Portable	Basic	Adj.by DIP S.W	Adj.by VR 14.4V:10.5~15.2V 28.8V:21~30.4V 57.6V:42~60.8V	Adj.by VR 50~100%	✗	T.B Anderson XLR	✗	180x 96x 49
NPB-450 NPB-750 NPB-1200 NPB-1700	Screw Mounted	Intelligent	Adj.by DIP S.W or SBP-001 with N.B	Auto ranging or SBP-001 14.4V:10.5~21V 28.8V:21~42V 57.6V:42~80V 72V:54~100V(450W only)		✓	T.B	✓	205x 130x 55 230x 158x 67 250x 158x 67 300x 184x 70
NPP-450 NPP-750 NPP-1200 NPP-1700		Advanced	3-stage only	Adj.by VR 14.4V:10.5~21V 28.8V:21~42V 57.6V:42~80V 72V:54~100V(450W only)		✗		205x 130x 55 230x 158x 67 250x 158x 67 300x 184x 70	



Features

- Intelligent charger with programmable 3 stage curve for lead-acid batteries and Li-ion batteries
- Universal AC input / Full range
- Withstand 300VAC surge input for 5 seconds
- Built-in I²C interface, PMBus protocol (optional CANBus)
- 1U low profile (41mm height)
- Rack mountable (RCB-1600), support hot swap (hot plug)
- Output voltage and current programmable
- Forced air cooling by built-in DC fan
- Built-in OR-ing FET
- Active current sharing up to 4800W (2+1) for RPB-1600, 8000W with one 19" rack shelf (RHP-1U□-A) for RCB-1600
- Protections: Battery under voltage / Battery no connection / Short circuit / Over voltage / Over temperature
- 3 color LED loading indicator
- Optional conformal coating
- 5 years warranty

General Specification (Please refer to www.meanwell.com for detail spec.)



Model	RPB-1600	RCB-1600
AC input voltage range	90 ~ 264VAC; 127 ~ 370VDC	
AC inrush current (max.)	Cold start, 35A at 230VAC	
DC adjustment range	Vo: -1%~+22.5% by potentiometer, or to 75%~125% of nominal output voltage by 1~5VDC external control signal Io: to 20%~100% of rated output current by 1-5VDC external control signal	
Over voltage protection	130%~155% shut down o/p voltage, re-power on to recover	
Working temperature	-30~+70°C (refer to output derating curve)	
Withstand voltage	I/P-O/P:3KVAC, I/P-FG:2KVAC, O/P-FG:1.5KVAC	
Safety standards	UL60950-1, TUV BS EN/EN60950-1, EAC TP TC 004 approved	
EMC standards	BS EN/EN55032 conduction class B, radiation class A; EN61000-3-2,3, EN61000-4-2,3,4,5,6,8,11; EN61000-6-2 heavy industry level criteria A, EAC TP TC 020	
Connection	Bus Bar	Positronic PCIM34W13M400A1
Dimension(LxWxH)(mm)	300x 85x 41	

1600W RPB-1600

Model No.	Output	Effi.
RPB-1600-12	14.4V, 0~100A	91.0%
RPB-1600-24	28.8V, 0~55A	92.5%
RPB-1600-48	57.6V, 0~27.5A	93.5%

1600W RCB-1600

Model No.	Output	Effi.
RCB-1600-12	14.4V, 0~100A	90.5%
RCB-1600-24	28.8V, 0~55A	92.0%
RCB-1600-48	57.6V, 0~27.5A	93.0%

3-Stage Charging Curve

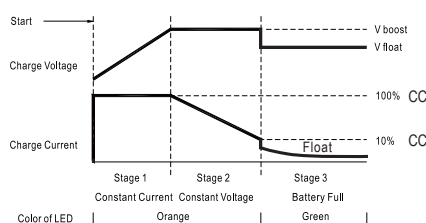

Model	Description	Vboost	Vfloat	CC (default)
12V	Default programmable	14.4	13.8	100A
	Pre-defined, gel battery	14	13.6	
	Pre-defined, flooded battery	14.2	13.4	
	Pre-defined, AGM battery	14.5	13.5	
24V	Default programmable	28.8	27.6	55A
	Pre-defined, gel battery	28	27.2	
	Pre-defined, flooded battery	28.4	26.8	
	Pre-defined, AGM battery	29	27	
48V	Default programmable	57.6	55.2	27.5A
	Pre-defined, gel battery	56	54.4	
	Pre-defined, flooded battery	56.8	53.6	
	Pre-defined, AGM battery	58	54	

Charger 3200W Stationary & Rack Type Programmable Charger

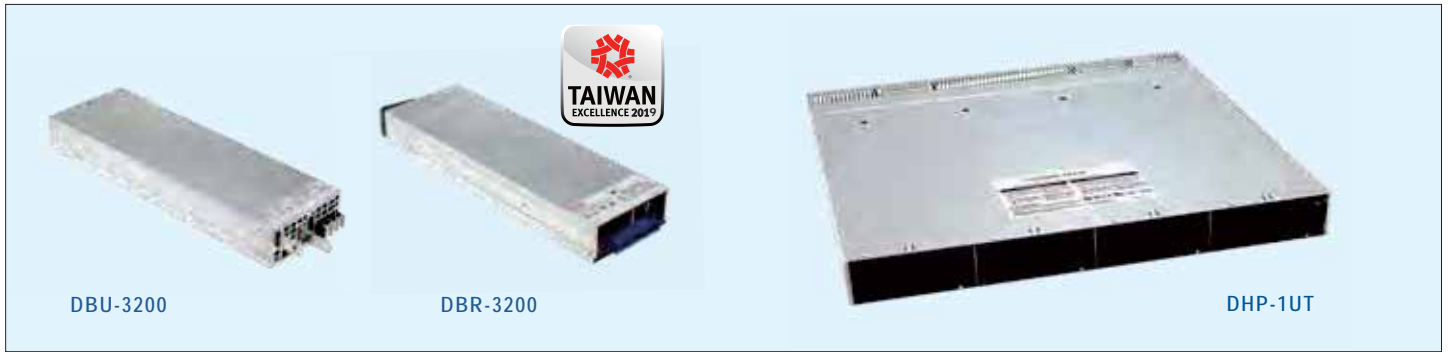

Features

- Universal AC Input / Full Range
- Charger for lead-acid (Gel, flooded and AGM) and Li-ion (Li-ion & Lithium Manganese) batteries
- Built-in default 3 stage charging curve and curve **programmable with SBP-001**(see page 97)
- High efficiency up to 94.5%
- High power density 37W/in³
- Cooling by built-in DC fan
- **PV** (Programmable Voltage) and **PC** (Programmable Constant Current)
- Built-in OR-ing MOSFET, **support hot swap/plug** (DBR-3200 only)
- Active **current sharing**, one 19" 1U rack up to **12800W**, two racks up to **25600W** in parallel
- I²C interface, support **PMBus** protocol (CANBus optional)
- Protections: Battery under voltage / Battery no connection / Short circuit / Over temperature / Over voltage
- Optional conformal coating
- **5 years warranty**

Order Information

DBU-3200-24

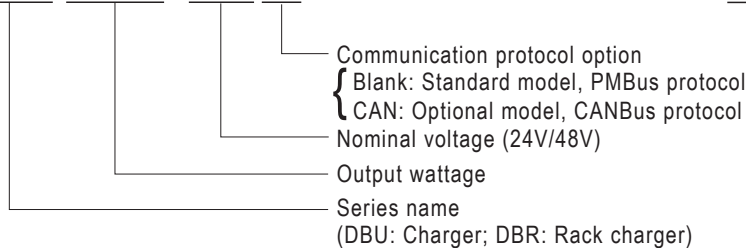

DHP-1U T - A

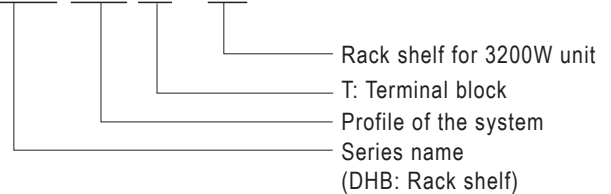

General Specification (Please refer to www.meanwell.com for detail spec.)



Order No.	DBU-3200	DBR-3200
AC input voltage range	90-264VAC; 127~370VDC	
AC inrush current (max.)	17A/230VAC, COLD START	
DC adjustment range	24V: 23.5-30V; 48V: 47.5-58.8V	
Over voltage protection	24V: 31.5-37.5V; 48V: 63-75V	
Working temperature	-30~+70°C (refer to output derating curve)	
Withstand voltage	I/P-O/P: 3KVAC; I/P-FG: 2KVAC; O/P-FG: 1.5KVAC (0.5KVAC for 24V)	
Safety standards	UL62368-1, TUV BS EN/EN62368-1, EAC TP TC 004 approved	
EMC standards	Compliance with BS EN/EN55032 (CISPR32) Conduction Class B, Radiation Class A; BS EN/EN61000-3-2,3, EAC TP TC 020, EN61000-4-2,3,4,5,6,8,11, EN61000-6-2(EN55082-2), light industry level, criteria A	
Connection	Bus Bar	Positronic PCIM34W13F400A1
Communication Protocol	PMBus; CANBus (optional)	
Dimension(LxWxH)(mm)	325x 107x 41	

3200W DBU-3200

Model No.	Output	Efficiency
DBU-3200-24	28.8V, 0~110A	93.5%
DBU-3200-48	57.6V, 0~55A	94.5%

3200W DBR-3200

Model No.	Output	Efficiency
DBR-3200-24	28.8V, 0~110A	93.5%
DBR-3200-48	57.6V, 0~55A	94.5%



■ Features

- For MEAN WELL's intelligent battery chargers:
Charging curve programmable suitable for models:
ENC-120/240/360, NPB-450/750/1200/1700, DRS-240/480,
HEP-1000, HEP-2300-55, RPB/RCB-1600, DBU/DBR-3200
- Simple connection and configuration
- No need of external battery or AC power
- LED status indicator

■ General Specification (Please refer to www.meanwell.com for detail spec.)

Model No.	SBP-001
Programming interface	PMBus, CANBus, UART
LED indicator	Green: 3.3V interface Orange: 5V interface
Programming volt.	5V and 3.3V, for programming purpose only. Total 0.5W(max.)
Comm. interface	USB
Working temperature	0~ +40°C
Dimension (LxWxH)(mm)	165x 46x 23

■ Description

The Smart Battery Charging Programmer Software is utilized for programming MEAN WELL's intelligent chargers, including ENC-120/240/360, NPB-450/750/1200/1700, DRS-240/480, HEP-1000, HEP-2300-55, RPB/RCB-1600, DBU/DBR-3200. The connection between personal computer (PC) and charger is established via the "programmer" hardware interface from MEAN WELL.

What function is provided?

Charging parameter adjustment: Values of constant current (CC), constant voltage (CV), float voltage (FV) and taper current (TC) can be set and adjusted.

Battery temperature compensation: Various charging voltage compensation is provided for battery at different temperature conditions.

Timeout setting: Fully programmable timeout during stages enables to be set to shutdown the charger to prevent battery over-charge.

■ Hardware Connection

Prior to program a driver, the connection between driver and PC must be established first via the Programmer shown in the figure below.

The following steps are suggested:

ENC series with SBP-001:

1. Remove the ENC from AC.
2. Connect Programmer and PC with the enclosed USB cable. LED (Green) of the Programmer is ON.
3. Connect the communication cable to CN31 of the ENC from the Programmer.

RPB/RCB & DBU/DBR series with SBP-001:

1. Remove the RPB/RCB & DBU/DBR from AC.
2. Connect Programmer and PC with the enclosed USB cable. LED (Green) of the Programmer is ON.
3. Connect the communication cable to CN1 and CN500 of the RPB/DBU from the Programmer; RCB/DBR requires working with a RHP/DHP rack, link the cable to JK1 of the rack.
4. Apply AC to the charger.
5. LED of the Programmer will light in Orange once connection is established successfully.

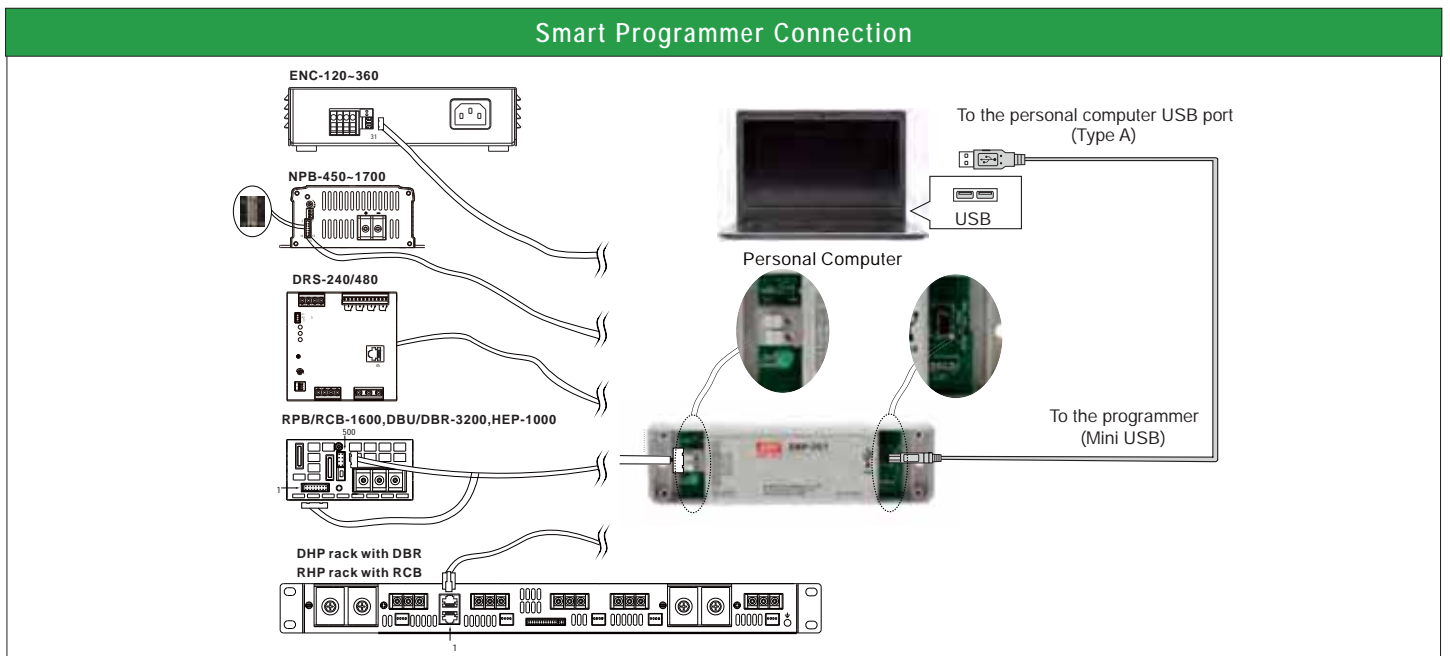

Charger & Bidirectional power supply



600W Harsh Environment Programmable Charger

- 3 stage charger for lead-acid batteries and Li-ion batteries in harsh environment
- Universal AC input **90~305VAC**
- Built-in active PFC function
- No load power consumption <0.5W at remote OFF
- High efficiency up to **96%**
- **Fanless design**, cooling by free air convection
- **-40~+70°C** wide operating range
- Aluminum case and filling with heat-conducted silicone
- Withstand **10G** vibration test
- Operating altitude up to 5000 meters
- Vo and Io can be adjusted through internal potentiometer
- Protections: Short circuit / Over voltage / Over temperature
- Temperature compensation function
- **6 years warranty**



- AC input voltage range 85~264VAC; 120~370VDC
- AC inrush current (max.)..... Cold start, 70A at 230VAC
- DC adjustment range Vo: 100%~125% rated output voltage
- Overload protection 135%~152% shut down o/p voltage, re-power on to recover
- Withstand voltage I/P-O/P: 3.75kVAC, I/P-FG: 2kVAC, O/P-FG: 1.5kVAC
- Working temperature -40~+70°C (refer to output derating curve)
- Safety standards UL62368-1 TUV BS EN/EN62368-1, EAC TP TC 004 approved
- EMC standards BS EN/EN55032 conduction class B, radiation class A; EN61000-3-2,3, EN61000-4-2,3,4,5,6,8,11, EAC TP TC 020
- Connection 3+7P / 11mm pitch terminal block with cover

Model No.	Output	Effi.
HEP-600C-12	14.4V, 0~35.0A	93.5%
HEP-600C-24	28.8V, 0~21.0A	94.5%
HEP-600C-48	57.6V, 0~10.5A	95.5%

2200W AC⇒DC Bidirection Power with Energy Recycle

- **93%** efficiency for both AC/DC and DC/AC conversion
- Ultrafast switching time of **1ms** (Fast responds & energy recycle)
- Active current sharing up to **11000W** with **4+1** units
- THDi <**3%**
- **CB/TUV/UL 62368-1** certified; design refer to IEC 62477-1 regulation(By request)
- Optional **CANBus** protocol
- Protections: Anti-islanding / AC fail / DC Over voltage / Overload / Over current / Over temperature
- **5 years warranty**



- DC adjustment range 12V: 12Vdc~15Vdc
24V: 24Vdc~28Vdc
48V: 48Vdc~65Vdc
96V: 96Vdc~112Vdc
- DC to AC current 12V: 150Adc, 24V: 75Adc, 48V: 37.5Adc
96V:18.5Adc
- DC to AC Effi. 12V: 90.5%(@112.5A), 24V: 93%(@56.3A)
48V: 93%(@28.1A), 96V: 93%(@13.9A)
- AC range 180~264VAC
- AC to DC current 12V: 180Adc, 24V: 90Adc, 48V: 45Adc,
96V:22.5Adc
- AC to DC Effi. 12V: 90%(@135A), 24V: 93%(@67.5A)
48V: 93%(@33.75A), 96V: 93%(@16.9A)
- AC ↔ DC switch time 1ms
- Safety standards UL62368-1, CAN/CSA C22.2 No.62368-1, TUV BS EN/EN62368-1, EAC TP TC 004, IEC62477-1(by request) approved
- EMC standards Compliance with BS EN/EN55032(CISPR32) Conduction ClassB,Radiation Class A; EN61000-3-2,3; EN61000-4-2,3,4,6,8,11;
- Force charging and discharging EN-61000-6-2,EAC TP TC 020
Optional **CANBus** protocol

Model No.	Output	Effi.
BIC-2200-12	12V, 0~180A	90%
BIC-2200-24	24V, 0~90A	93%
BIC-2200-48	48V, 0~45A	93%
BIC-2200-96	96V, 0~22.5A	93%

DC/AC Inverter 250~400W High Reliable Built-in Type True Sine Wave

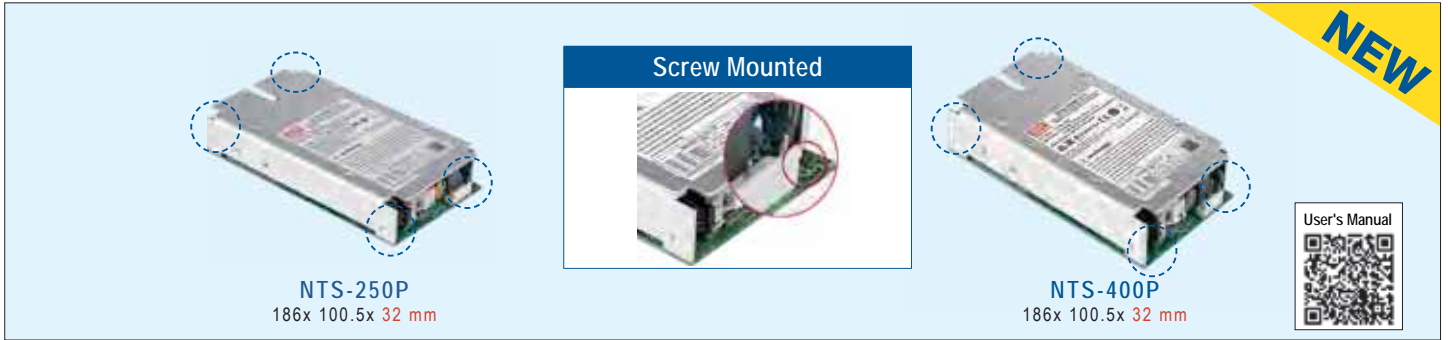

Features

- True sine wave output (THD<3%)
- 200% high surge power for heavy load
- Fanless design, no noise
- AC output voltage and frequency selectable by DIP S.W
- No load dissipation <1.5W max. at standby saving mode
- -20~+70°C wide operating temperature
- Power ON-OFF remote control
- Protections:
 - DC Input: Reverse polarity / DC low alarm / DC low shutdown / Over voltage / Battery over discharge protection
 - AC Output: Short circuit / Overload / Over temp.
- Support Tx/Rx for monitoring power inverter status
- Suitable for lead-acid or li-ion batteries
- Conformal coating
- 3 years warranty

General Specification (Please refer to www.meanwell.com for detail spec.)



Model No.	NTS-250P	NTS-400P
Rated Power(Continuos)	250W	400W
Surge Power (30 Cycles.)	500W	800W
DC input rated voltage	12V, 24V, 48V	
AC output voltage	110 Vac model: 100 / 110 / 115 / 120 Vac selectable by DIP S.W 230 Vac model: 200 / 220 / 230 / 240 Vac selectable by DIP S.W	
Output frequency	50 / 60Hz selectable by DIP S.W	
AC output waveform	True sine wave (THD<3%)	
AC output regulation	±3.0% at rated input voltage	
No load dissipation	Saving mode default disable, ≤1.2W ~ 1.5W by models @ auto detec AC output load ≤10W will be changed to saving mode	
Working temperature	-20 ~ +70°C(Refer to "Derating curve")	
Safety standard	110 Vac	CB IEC62368-1 approved
	230 Vac	CB IEC62368-1,E13,EAC TPTC004,AS/NZS 62368.1 approved
EMC standards	110 Vac	FCC
	230 Vac	BS EN/EN55032, EN61000-4-2.3.8 , EAC TPTC020

250W NTS-250P				
Model No.	Continue power	Input (Vdc)	Output (Vac / Hz)	Effi.
NTS-250P-112P	250W	10.0-16.5	110 / 60	91%
NTS-250P-124P	250W	20.0-33.0	110 / 60	91%
NTS-250P-148P	250W	40.0-66.0	110 / 60	92%
NTS-250P-212P	250W	10.0-16.5	230 / 50	92%
NTS-250P-224P	250W	20.0-33.0	230 / 50	93%
NTS-200P-248P	250W	40.0-66.0	230 / 50	93%

400W NTS-400P				
Model No.	Continue power	Input (Vdc)	Output (Vac / Hz)	Effi.
NTS-400P-112	400W	10.0-16.5	110 / 60	89%
NTS-400P-124	400W	20.0-33.0	110 / 60	91%
NTS-400P-148	400W	40.0-66.0	110 / 60	91%
NTS-400P-212	400W	10.0-16.5	230 / 50	91%
NTS-400P-224	400W	20.0-33.0	230 / 50	93%
NTS-400P-248	400W	40.0-66.0	230 / 50	93%

AC Socket Type

MODEL	100~120Vac model			200~240Vac model			
Socket type							
Country							

DC/AC Inverter 300~750W High Reliable True Sine Wave



NEW



NTS-300
210x 130x 55 mm
(Fanless)



NTS-450
210x 130x 55 mm
(Built-in Fan)



NTS-750
270x 158x 67 mm
(Built-in Fan)



Features

- Compact size and light weight
- True sine wave output (THD<3%)
- 200% high surge power for heavy load
- AC output voltage and frequency selectable by DIP S.W
- No load dissipation <1.5W max. at standby saving mode
- -20 ~+70 wide operating temperature
- Power ON-OFF remote control
- Remote controller (IRC1,IRC2,IRC3,accessory sold separately)for NTS-750
- Protections :
DC Input: Reverse polarity / DC low alarm / DC low shutdown / Over voltage / Battery over discharge protection
AC Output: Short circuit / Overload / Over temp
- Support RS-232 communication (Communication cable order NO.:RJ11-RS232,sold sperately)
- Suitable for lead-acid or li-ion batteries
- Conformal coating
- Pull handle accessory available (Order NO.:carry handle,sold sperately)
- 3 years warranty

General Specification (Please refer to www.meanwell.com for detail spec.)



Model No.	NTS-300	NTS-450	NTS-750
Rated Power(Continuos)	300W	450W	750W
Surge Power (30 Cycles.)	600W	900W	1500W
DC input rated voltage	12V, 24V, 48V		
AC output voltage	110Vac model: 100 / 110 / 115 / 120Vac selectable by DIP S.W 230Vac model: 200 / 220 / 230 / 240Vac selectable by DIP S.W		
Output frequency	50/60Hz selectable by DIP S.W		
AC output waveform	True sine wave (THD<3%)		
AC output regulation	±3.0% at rated input voltage		
No load dissipation	Saving mode default disable, ≤1.2W ~ 1.5W by models @ auto detec AC output load≤10W will be changed to saving mode		
Working temperature	-25 ~ +65°C(Refer to "Derating curve")	-25 ~ +70°C(Refer to "Derating curve")	
Safety standard	110Vac Model	CB IEC62368-1(Expect for UN Type),Dekra BS EN/EN62368-1(Expect for GFCI/UN-Type), UL458(750W only) approved	
	230Vac Model	CB IEC62368-1(Expect for UN Type),Dekra BS EN/EN62368-1(Expect for UN-Type)E13,EAC,AS/NZS62368.1 approved	
EMC	110Vac Model	FCC (Expect for UN-Type)	
	230Vac Model	BS EN/EN55032, EN61000-4,2,3,8; EAC TP TC020(Expect for UN-Type)	

300W NTS-300

Model No.	Continue power	Input (Vdc)	Output (Vac / Hz)	Effi.
NTS-300-112 <input type="checkbox"/>	300W	10.0-16.5	110 / 60	90%
NTS-300-124 <input type="checkbox"/>	300W	20.0-33.0	110 / 60	92%
NTS-300-148 <input type="checkbox"/>	300W	40.0-66.0	110 / 60	92%
NTS-300-212 <input type="checkbox"/>	300W	10.0-16.5	230 / 50	92%
NTS-300-224 <input type="checkbox"/>	300W	20.0-33.0	230 / 50	93%
NTS-300-248 <input type="checkbox"/>	300W	40.0-66.0	230 / 50	93%

Model No.	Continue power	Input (Vdc)	Output (Vac / Hz)	Effi.
NTS-450-148	450W	40.0-66.0	110 / 60	91%
NTS-450-212	450W	10.0-16.5	230 / 50	90%
NTS-450-224	450W	20.0-33.0	230 / 50	93%
NTS-450-248	450W	40.0-66.0	230 / 50	93%

450W NTS-450

Model No.	Continue power	Input (Vdc)	Output (Vac / Hz)	Effi.
NTS-450-112 <input type="checkbox"/>	450W	10.0-16.5	110 / 60	89%
NTS-450-124 <input type="checkbox"/>	450W	20.0-33.0	110 / 60	90%

750W NTS-750

Model No.	Continue power	Input (Vdc)	Output (Vac / Hz)	Effi.
NTS-750-112 <input type="checkbox"/>	750W	10.0-16.5	110 / 60	89%
NTS-750-124 <input type="checkbox"/>	750W	20.0-33.0	110 / 60	90%
NTS-750-148 <input type="checkbox"/>	750W	40.0-66.0	110 / 60	91%
NTS-750-212 <input type="checkbox"/>	750W	10.0-16.5	230 / 50	90%
NTS-750-224 <input type="checkbox"/>	750W	20.0-33.0	230 / 50	93%
NTS-750-248 <input type="checkbox"/>	750W	40.0-66.0	230 / 50	93%

= AC output socket; Type US/GFCI/UN for 110Vac models, Type-EU/CN/UK/AU/UN for 230Vac models;please refer to page 99

1	2	3	4
100	200	50	
110	220		
115	230	0	
120	240		

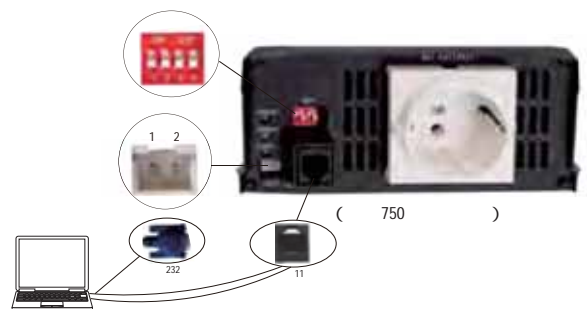

DC/AC Inverter 1200~3200W High Reliable True Sine Wave



Coming Soon



NEW

NTS-1200
333x 184x 70 mm



NTS-1700
400x 184x 70 mm



NTS-2200
420x 270x 98 mm



NTS-3200
420x 270x 98 mm

Features

- Compact size and light weight
- True sine wave output (THD<3%)
- 200% high surge power for heavy load
- AC output voltage and frequency selectable by DIP S.W
- No load dissipation <1.5W max. at standby saving mode
- -25 ~+70 wide operating temperature
- Power ON-OFF remote control
- Remote controller (IRC1,IRC2,IRC3,accessory sold separately)
- Protections :
DC Input: Reverse polarity / DC low alarm / DC low shutdown / Over voltage Battery over discharge protection
AC Output: Short circuit / Overload / Over temp
- Support RS-232 communication (Communication cable order NO.:RJ11-RS232,sold sperately)
- Suitable for lead-acid or li-ion batteries
- Conformal coating
- Pull handle accessory available (Order NO.:Carry handle,sold sperately)
- 3 years warranty

General Specification (Please refer to www.meanwell.com for detail spec.)



Model No.	NTS-1200	NTS-1700	NTS-2200	NTS-3200
Rated Power(Continuos)	1200W	110Vac:1500W,230Vac:1700W	2200W	110Vac:3000W,230Vac:3200W
Surge Power (30 Cycles.)	2000W	110Vac:3000W,230Vac:3400W	4400W	110Vac:6000W,230Vac:6400W
DC input rated voltage	12Vdc, 24Vdc or 48Vdc			
AC output voltage	110Vac model: 100 / 110 / 115 / 120Vac selectable by DIP S.W , 230Vac model: 200 / 220 / 230 / 240Vac selectable by DIP S.W			
Output frequency	50/60Hz selectable by DIP S.W			
AC output waveform	True sine wave (THD<3%)			
AC output regulation	±3.0% at rated input voltage			
No load dissipation	Saving mode default disable,≤1.2W ~ 1.8W by models @ auto detec AC output load≤10W will be changed to saving mode			
Working temperature	-25~+70°C(Refer to "Derating curve")			
Safety standard	110Vac Model	CB IEC62368-1(Expect for UN Type),Dekra BS EN/EN62368-1(Expect for GFCI/UN-Type), UL458 approved		
	230Vac Model	CB IEC62368-1(Expect for UN Type),Dekra BS EN/EN62368-1(Expect for UN-Type),E13,EAC,AS/NZS62368.1 approved		
EMC	110Vac Model	FCC (Expect for UN-Type)		
	230Vac Model	BS EN/EN55032, EN61000-4,2,3,8; EAC TP TC020(Expect for UN-Type)		

1200W

NEW NTS-1200

Model No.	Continue power	Input (Vdc)	Output (Vac / Hz)	Effi.
NTS-1200-112 □	1200W	10.0-16.5	110 / 60	89%
NTS-1200-124 □	1200W	20.0-33.0	110 / 60	91%
NTS-1200-148 □	1200W	40.0-66.0	110 / 60	91.5%
NTS-1200-212 □	1200W	10.0-16.5	230 / 50	90%
NTS-1200-224 □	1200W	20.0-33.0	230 / 50	92%
NTS-1200-248 □	1200W	40.0-66.0	230 / 50	93%

2200W

Coming Soon NTS-2200

Model No.	Continue power	Input (Vdc)	Output (Vac / Hz)	Effi.
NTS-2200-112 □	2200W	10.0-16.5	110 / 60	89%
NTS-2200-124 □	2200W	20.0-33.0	110 / 60	91%
NTS-2200-148 □	2200W	40.0-66.0	110 / 60	92%
NTS-2200-212 □	2200W	10.0-16.5	230 / 50	90%
NTS-2200-224 □	2200W	20.0-33.0	230 / 50	92%
NTS-2200-248 □	2200W	40.0-66.0	230 / 50	93%

1700W

Coming Soon NTS-1700

Model No.	Continue power	Input (Vdc)	Output (Vac / Hz)	Effi.
NTS-1700-112 □	1500W	10.0-16.5	110 / 60	89%
NTS-1700-124 □	1500W	20.0-33.0	110 / 60	90%
NTS-1700-148 □	1500W	40.0-66.0	110 / 60	91%
NTS-1700-212 □	1700W	10.0-16.5	230 / 50	90%
NTS-1700-224 □	1700W	20.0-33.0	230 / 50	92%
NTS-1700-248 □	1700W	40.0-66.0	230 / 50	93%

3200W

Coming Soon NTS-3200

Model No.	Continue power	Input (Vdc)	Output (Vac / Hz)	Effi.
NTS-3200-112 □	3000W	10.0-16.5	110 / 60	89%
NTS-3200-124 □	3000W	20.0-33.0	110 / 60	90%
NTS-3200-148 □	3000W	40.0-66.0	110 / 60	91%
NTS-3200-212 □	3200W	10.0-16.5	230 / 50	90%
NTS-3200-224 □	3200W	20.0-33.0	230 / 50	92%
NTS-3200-248 □	3200W	40.0-66.0	230 / 50	93%

□ = AC output socket ; Type-US/GFCI/UN for 110Vac models, Type-EU/CN/UK/AU/UN for 230Vac models;please refer to page 99

DC/AC Inverter 1200~3200W High Reliable True Sine Wave with UPS



Features

- Built-in UPS function (AC by-pass)
- True sine wave output (THD<3%)
- 200% high surge power for heavy load
- AC output voltage and frequency selectable by DIP S.W
- No load dissipation < 9W max. at standby saving mode
- -25~+70 wide operating temperature
- Power ON-OFF remote control
- Remote controller (IRC1,IRC2,IRC3 accessory sold separately)
- Protections :
 - DC Input: Reverse polarity / DC low alarm / DC low shutdown / Over voltage Battery over discharge protection
 - AC Output: Short circuit / Overload / Over temp.
- Support RS-232 communication (Communication cable order NO.:RJ11-RS232,sold sperately)
- Suitable for lead-acid or li-ion batteries
- Conformal coating
- Pull handle accessory available (Order NO.:Carry handle,sold separately)
- 3 years warranty

General Specification (Please refer to www.meanwell.com for detail spec.)



Model No.	NTU-1200	NTU-1700	NTU-2200	NTU-3200
Rated Power(Continuos)	1200W	110Vac:1500W,230Vac:1700W	2200W	110Vac:3000W,230Vac:3200W
Surge Power (30 Cycles.)	2000W	110Vac:3000W,230Vac:3400W	4400W	110Vac:6000W,230Vac:6400W
DC input rated voltage	12Vdc, 24Vdc or 48Vdc			
AC output voltage	110Vac model: 100 / 110 / 115 / 120Vac selectable by DIP S.W , 230Vac model:200 / 220 / 230 / 240Vac selectable by DIP S.W			
Output frequency	50/60Hz selectable by DIP S.W			
AC output waveform	True sine wave (THD<3%)			
AC output regulation	±3.0% at rated input voltage			
No load dissipation	Saving mode default disable, ≤8W ~ 9W by models @ auto detec AC output load≤10W will be changed to saving mode			
AC by-pass	10ms; Inverter mode ⇌ AC by pass mode			
Working temperature	-25~+70°C(Refer to "Derating curve")			
Safety standard	110Vac Model	CB IEC62368-1(Expect for UN Type),Dekra BS EN/EN62368-1(Expect for GFCI/UN-Type), UL458 approved		
	230Vac Model	CB IEC62368-1(Expect for UN Type),Dekra BS EN/EN62368-1(Expect for UN-Type),E13,EAC,AS/NZS62368.1 approved		
EMC	110Vac Model	FCC (Expect for UN-Type)		
	230Vac Model	BS EN/EN55032, EN61000-4,2,3,8; EAC TP TC020(Expect for UN-Type)		

1200W NEW NTU-1200

Model No.	Continue power	Input (Vdc)	Output (Vac / Hz)	Effi.
NTU-1200-112 □	1200W	10.0-16.5	110 / 60	89%
NTU-1200-124 □	1200W	20.0-33.0	110 / 60	90%
NTU-1200-148 □	1200W	40.0-66.0	110 / 60	91%
NTU-1200-212 □	1200W	10.0-16.5	230 / 50	90%
NTU-1200-224 □	1200W	20.0-33.0	230 / 50	92%
NTU-1200-248 □	1200W	40.0-66.0	230 / 50	93%

2200W Coming Soon NTU-2200

Model No.	Continue power	Input (Vdc)	Output (Vac / Hz)	Effi.
NTU-2200-112 □	2200W	10.0-16.5	110 / 60	89%
NTU-2200-124 □	2200W	20.0-33.0	110 / 60	91%
NTU-2200-148 □	2200W	40.0-66.0	110 / 60	92%
NTU-2200-212 □	2200W	10.0-16.5	230 / 50	90%
NTU-2200-224 □	2200W	20.0-33.0	230 / 50	92%
NTU-2200-248 □	2200W	40.0-66.0	230 / 50	93%

1700W Coming Soon NTU-1700

Model No.	Continue power	Input (Vdc)	Output (Vac / Hz)	Effi.
NTU-1700-112 □	1500W	10.0-16.5	110 / 60	89%
NTU-1700-124 □	1500W	20.0-33.0	110 / 60	90%
NTU-1700-148 □	1500W	40.0-66.0	110 / 60	91%
NTU-1700-212 □	1700W	10.0-16.5	230 / 50	90%
NTU-1700-224 □	1700W	20.0-33.0	230 / 50	92%
NTU-1700-248 □	1700W	40.0-66.0	230 / 50	93%

3200W Coming Soon NTU-3200

Model No.	Continue power	Input (Vdc)	Output (Vac / Hz)	Effi.
NTU-3200-112 □	3000W	10.0-16.5	110 / 60	89%
NTU-3200-124 □	3000W	20.0-33.0	110 / 60	90%
NTU-3200-148 □	3000W	40.0-66.0	110 / 60	91%
NTU-3200-212 □	3200W	10.0-16.5	230 / 50	90%
NTU-3200-224 □	3200W	20.0-33.0	230 / 50	92%
NTU-3200-248 □	3200W	40.0-66.0	230 / 50	93%

□ = AC output socket; Type-US/GFCI/UN for 110Vac models, Type-EU/CN/UK/AU/UN for 230Vac models;please refer to page 99

DC/AC Inverter

200~3000W True Sine Wave



Features

- True sine wave output (THD<3%)
- **200% high surge power for motor related application**
- Advanced digital control by microprocessor
- Output voltage / frequency adjustable
- High efficiency up to 92%
- **Conformal coating for TS-700**
- Standby saving mode to conserve energy (TS-700)
- Fanless design (TS-200)
- Front panel indicator for load / battery / operation status
- DC Input protections: Bat. low alarm / Bat. low shutdown / Reverse polarity / Over voltage
- AC Output protections: Short circuit / Overload / Over temperature
- Applications: Home appliance, power tools, office and portable equipment, vehicle and yacht...etc.
- 3 years warranty



General Specification (Please refer to www.meanwell.com for detail spec.)

Model Name	TS-200	TS-400	TS-700	TS-1000	TS-1500	TS-3000
Rated power(continuous)	200W	400W	700W	1000W	1500W	3000W
Output surge rating (30 cycles.)	400W	800W	1400W	2000W	3000W	6000W
DC input rated voltage	12Vdc, 24Vdc or 48Vdc					
AC output voltage	100 / 110 / 115 / 120Vac; 200 / 220 / 230 / 240Vac selectable by setting button					
Output frequency	50Hz / 60Hz selectable by setting button					
AC output waveform	True sine wave, THD<3.0%					
AC output regulation	±3% of rated output voltage					
No load dissipation	≤15W @ standby saving mode		≤6W @ standby saving mode		≤18W @ standby saving mode	≤10W @ standby saving mode
Working temperature	-10~+60 (Refer to "Derating curve")		0~+60 (Refer to "Derating curve")			
Safety standards	110V	UL458(TS-1000-112/124 GFCI socket only), EAC TP TC004 approved			UL458 (except for 48V and only for GFCI receptacle), EAC TP TC004 approved	
	230V	CB IEC62368-1, EAC TP TC004			BS EN/EN60950-1, EAC TP TC004	
EMC standards	110V	FCC class A(112/124/148 only), EAC TP TC020			FCC class A, EAC TP TC020	
	230V	BS EN/EN55032 class A, EN61000-4-2,3,8, E-Mark, EAC TP TC020			BS EN/EN55032 class A (class B for TS-1500), E-Mark, EN61000-4-2,3,8, ENV50204, EAC TP TC020	

200W

Model No.	Continue power	Input (Vdc)	Output (Vac / Hz)	Output socket	Effi.
TS-200-112[A]	200W	10.5-15	110 / 60	TYPE-A	86.0%
TS-200-124[A]	200W	21.0-30	110 / 60	TYPE-A	87.5%
TS-200-148[A]	200W	42.0-60	110 / 60	TYPE-A	88.0%
TS-200-212[B]	200W	10.5-15	230 / 50	TYPE-B	86.0%
TS-200-224[B]	200W	21.0-30	230 / 50	TYPE-B	87.5%
TS-200-248[B]	200W	42.0-60	230 / 50	TYPE-B	88.0%

1000W

Model No.	Continue power	Input (Vdc)	Output (Vac / Hz)	Output socket	Effi.
TS-1000-112[A]	1000W	10.5-15	110 / 60	TYPE-A	88%
TS-1000-124[A]	1000W	21.0-30	110 / 60	TYPE-A	89%
TS-1000-148[A]	1000W	42.0-60	110 / 60	TYPE-A	90%
TS-1000-212[B]	1000W	10.5-15	230 / 50	TYPE-B	90%
TS-1000-224[B]	1000W	21.0-30	230 / 50	TYPE-B	91%
TS-1000-248[B]	1000W	42.0-60	230 / 50	TYPE-B	92%

400W

Model No.	Continue power	Input (Vdc)	Output (Vac / Hz)	Output socket	Effi.
TS-400-112[A]	400W	10.5-15	110 / 60	TYPE-A	84.5%
TS-400-124[A]	400W	21.0-30	110 / 60	TYPE-A	86.0%
TS-400-148[A]	400W	42.0-60	110 / 60	TYPE-A	87.0%
TS-400-212[B]	400W	10.5-15	230 / 50	TYPE-B	86.0%
TS-400-224[B]	400W	21.0-30	230 / 50	TYPE-B	87.5%
TS-400-248[B]	400W	42.0-60	230 / 50	TYPE-B	88.5%

1500W

Model No.	Continue power	Input (Vdc)	Output (Vac / Hz)	Output socket	Effi.
TS-1500-112[A]	1500W	10.5-15	110 / 60	TYPE-A	87%
TS-1500-124[A]	1500W	21.0-30	110 / 60	TYPE-A	89%
TS-1500-148[A]	1500W	42.0-60	110 / 60	TYPE-A	90%
TS-1500-212[B]	1500W	10.5-15	230 / 50	TYPE-B	88%
TS-1500-224[B]	1500W	21.0-30	230 / 50	TYPE-B	90%
TS-1500-248[B]	1500W	42.0-60	230 / 50	TYPE-B	91%

700W

Model No.	Continue power	Input (Vdc)	Output (Vac / Hz)	Output socket	Effi.
TS-700-112[A]	700W	10.5-15	110 / 60	TYPE-A	86%
TS-700-124[A]	700W	21.0-30	110 / 60	TYPE-A	88%
TS-700-148[A]	700W	42.0-60	110 / 60	TYPE-A	89%
TS-700-212[B]	700W	10.5-15	230 / 50	TYPE-B	89%
TS-700-224[B]	700W	21.0-30	230 / 50	TYPE-B	90%
TS-700-248[B]	700W	42.0-60	230 / 50	TYPE-B	91%

3000W

Model No.	Continue power	Input (Vdc)	Output (Vac / Hz)	Output socket	Effi.
TS-3000-112[A]	3000W	10.5-15	110 / 60	TYPE-A	88%
TS-3000-124[A]	3000W	21.0-30	110 / 60	TYPE-A	90%
TS-3000-148[A]	3000W	42.0-60	110 / 60	TYPE-A	91%
TS-3000-212[B]	3000W	10.5-15	230 / 50	TYPE-B	89%
TS-3000-224[B]	3000W	21.0-30	230 / 50	TYPE-B	91%
TS-3000-248[B]	3000W	42.0-60	230 / 50	TYPE-B	92%

□ = A, B (standard model), C, D or F (optional model)

DC/AC Inverter 1500~3000W True Sine Wave with AC & Solar Charger

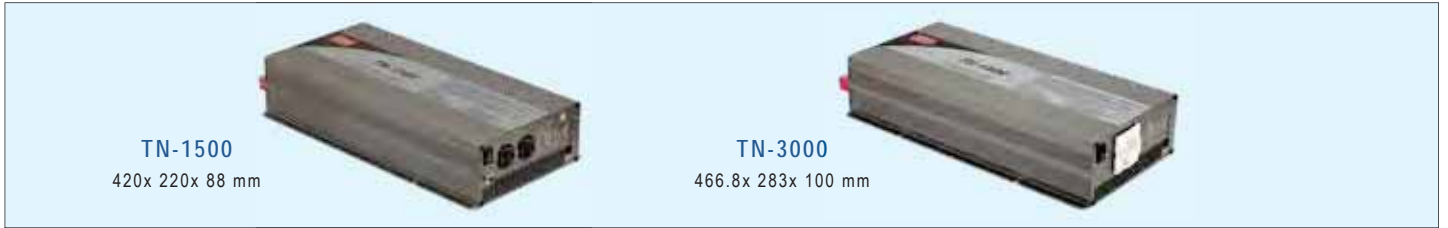

Features

- True sine wave output (THD<3%)
- **200% high surge power** for heavy load
- Advanced digital control by microprocessor
- Output voltage / frequency selectable
- High efficiency up to 91%
- Front panel indicator for load / battery / operation status
- High frequency design
- Protections:
 - DC Input: Bat. low alarm / Bat. low shutdown / Reverse polarity / Over voltage
 - AC Output: Short circuit / Overload / Over temperature
- Applications: Home appliance, power tools, office and portable equipment, vehicle and yacht...etc.
- 3 years warranty

General Specification (Please refer to www.meanwell.com for detail spec.)



Model No.	TN-1500	TN-3000
Rated output power(Continuos)	1500W	3000W
Surge power (30 cycles)	3000W	6000W
DC input rated voltage	12Vdc, 24Vdc or 48Vdc	
AC output voltage	100 / 110 / 115 / 120Vac or 200 / 220 / 230 / 240Vac adjustable via front panel or monitoring software	
AC output regulation (Typ.)	±3% of rated output voltage	
No load dissipation (Typ.)	≤18W @ standby saving mode	≤10W @ standby saving mode
Output frequency	50Hz/60Hz selectable via front panel or monitoring software	
AC output waveform	True sine wave, THD<3.0%	
Transfer time (Typ.)	10ms; inverter mode ⇌ Bypass mode	
Working temperature	0~+60°C	
Safety standards	110Vac	UL458 approved (112/124 GFCI socket only), EAC TP TC004 approved
	230Vac	CB IEC62368-1, EAC TP TC 004 approved
EMC standards	110Vac	FCC part 15 class A(112/124/148), EAC TP TC020
	230Vac	BS EN/EN55032 class A (class B for TN-1500), EN61000-4-2,3,4,5,6,8,11, E-Mark, EAC TP TC020

1500W (Inverter with AC & Solar Charger)

Model No.	Continue power	Input VDC	Output VAC / Hz	Output socket	Effi.
TN-1500-112[A]	1500W	10.5-15	110 / 60	TYPE-A	87%
TN-1500-124[A]	1500W	21.0-30	110 / 60	TYPE-A	89%
TN-1500-148[A]	1500W	42.0-60	110 / 60	TYPE-A	89%
TN-1500-212[B]	1500W	10.5-15	230 / 50	TYPE-B	88%
TN-1500-224[B]	1500W	21.0-30	230 / 50	TYPE-B	90%
TN-1500-248[B]	1500W	42.0-60	230 / 50	TYPE-B	91%

3000W (Inverter with AC & Solar Charger)

Model No.	Continue power	Input VDC	Output VAC / Hz	Output socket	Effi.
TN-3000-112[A]	3000W	10.5-15	110 / 60	TYPE-A	88%
TN-3000-124[A]	3000W	21.0-30	110 / 60	TYPE-A	90%
TN-3000-148[A]	3000W	42.0-60	110 / 60	TYPE-A	91%
TN-3000-212[B]	3000W	10.5-15	230 / 50	TYPE-B	89%
TN-3000-224[B]	3000W	21.0-30	230 / 50	TYPE-B	91%
TN-3000-248[B]	3000W	42.0-60	230 / 50	TYPE-B	92%

□ = A, B (standard model), C, D, F or G (optional model)

Solar Inverter Block Diagram (Inverter with AC & Solar Charger)

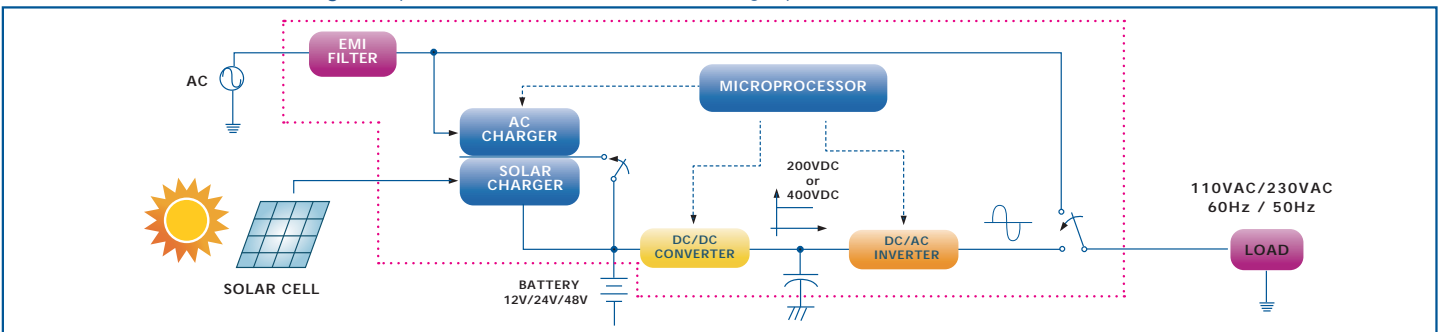



Features

- High frequency design
- Protections:
 - DC Input : Reverse polarity / Over and under voltage / Battery low alarm and shutdown
 - DC Output: Short circuit / Overload / Over temp.
- With power ON/OFF switch and LED indicator
- Remote ON/OFF controller for 1000~2500W (sold separately)
- Built-in USB 5Vdc/0.5A and without fan for 100W
- Input and output are fully isolated
- **Low cost**
- 1 year warranty

Output Socket (optional)

TYPE-1	TYPE-2	TYPE-3	TYPE-4	TYPE-5	TYPE-6
JAPAN	USA	EUROPE	UNIVERSAL	AUSTRALIA	U.K.

▶ Please consult MEAN WELL for other kinds of optional socket.
TYPE-2,3 (standard model) ; TYPE-1,4,5,6 (optional model)

General Specification (Please refer to www.meanwell.com for detail spec.)



Model Name	A301	A302
DC input rated voltage	12.5Vdc	25.0Vdc
AC output voltage / Frequency	110Vac(rms) / 60Hz or 230Vac(rms) / 50Hz	
Max. output power	100W, 150W, 300W, 600W, 1000W, 1500W, 2500W	
USB output power	5Vdc / 500mA (100W only)	
AC output regulation	±10% of rated output voltage	
Bat. low alarm	10±0.5Vdc	20.5±1.0Vdc
Bat. low shut down	9.5±0.5Vdc	19.5±1.0Vdc
I/P over voltage protection	15~17Vdc	30~32Vdc
Working temperature	0~30°C (0~25°C for 2500W)	
LVD	BS EN/EN62368-1 and E13	
EMC	BS EN/EN55014-1, EN61000-3-2,3, EN61000-4-2,4,5,6,11, EN55022, EAC TP TC020	

100W

Model Name	Continue power	Input (Vdc)	Output (Vac / Hz)	Output socket	Effi.
A301-100-F3	100W	10-15	230 / 50	TYPE-3	90%
A302-100-F3	100W	21-30	230 / 50	TYPE-3	90%

150W

Model Name	Continue power	Input (Vdc)	Output (Vac / Hz)	Output socket	Effi.
A301-150-B2	150W	10-15	110 / 60	TYPE-2	78%
A301-150-F3	150W	10-15	230 / 50	TYPE-3	78%
A302-150-B2	150W	21-30	110 / 60	TYPE-2	82%
A302-150-F3	150W	21-30	230 / 50	TYPE-3	82%

300W

Model Name	Continue power	Input (Vdc)	Output (Vac / Hz)	Output socket	Effi.
A301-300-B2	300W	10-15	110 / 60	TYPE-2	82%
A301-300-F3	300W	10-15	230 / 50	TYPE-3	82%
A302-300-B2	300W	21-30	110 / 60	TYPE-2	85%
A302-300-F3	300W	21-30	230 / 50	TYPE-3	85%

600W

Model Name	Continue power	Input (Vdc)	Output (Vac / Hz)	Output socket	Effi.
A301-600-B2	600W	10-15	110 / 60	TYPE-2	82%
A301-600-F3	600W	10-15	230 / 50	TYPE-3	82%
A302-600-B2	600W	21-30	110 / 60	TYPE-2	85%
A302-600-F3	600W	21-30	230 / 50	TYPE-3	85%

1000W

Model Name	Continue power	Input (Vdc)	Output (Vac / Hz)	Output socket	Effi.
A301-1K0-B2	1000W	10-15	110 / 60	TYPE-2	82%
A301-1K0-F3	1000W	10-15	230 / 50	TYPE-3	82%
A302-1K0-B2	1000W	21-30	110 / 60	TYPE-2	85%
A302-1K0-F3	1000W	21-30	230 / 50	TYPE-3	85%

1500W

Model Name	Continue power	Input (Vdc)	Output (Vac / Hz)	Output socket	Effi.
A301-1K7-B2	1500W	10-15	110 / 60	TYPE-2	82%
A301-1K7-F3	1500W	10-15	230 / 50	TYPE-3	82%
A302-1K7-B2	1500W	21-30	110 / 60	TYPE-2	85%
A302-1K7-F3	1500W	21-30	230 / 50	TYPE-3	85%

2500W

Model Name	Continue power	Input (Vdc)	Output (Vac / Hz)	Output socket	Effi.
A301-2K5-B4	2500W	10-15	110 / 60	TYPE-4	82%
A301-2K5-F3	2500W	10-15	230 / 50	TYPE-3	82%
A302-2K5-B4	2500W	21-30	110 / 60	TYPE-4	85%
A302-2K5-F3	2500W	21-30	230 / 50	TYPE-3	85%

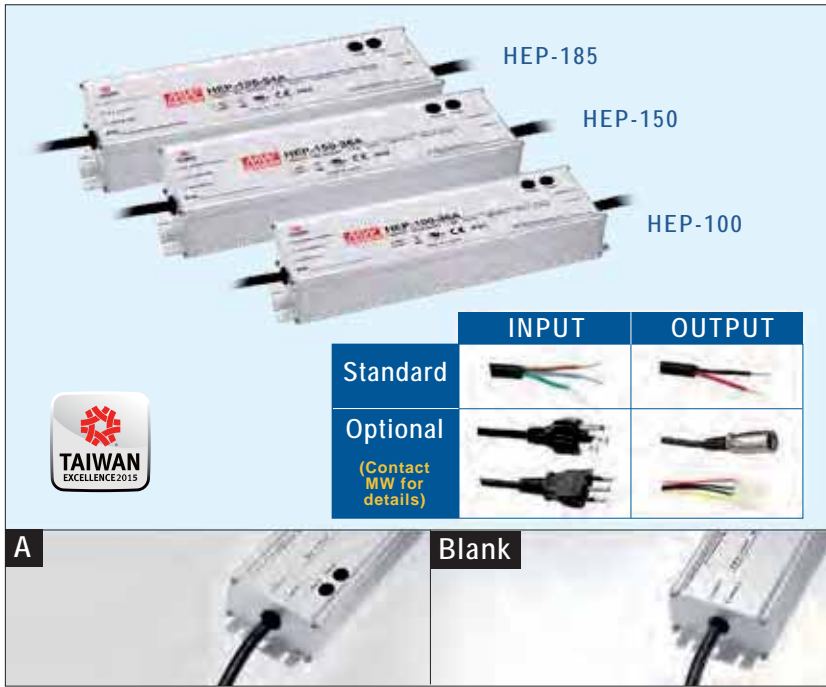

Features

- Universal AC input 90~305VAC
- High efficiency up to 94%
- **Fanless design**, cooling by free air convection
- **Ultra-wide operating temperature**
- Meet 6kV surge immunity level
- Withstand 10G vibration test
- Operating altitude up to 5000 meters
- Protections:
Short circuit / Overload / Over voltage / Over temperature
- Multiple models for choice:
A-Type: **IP65 rated**, Vo and Io can be adjusted through internal potentiometer
Blank-Type(option): **IP68 rated**, Vo and Io fixed
- Suitable for general industrial applications at high/low temperature, high dust, high moisture, high vibration, high salt or outdoor environment
- **6 years warranty**

IP68 IP65

General Specification (Please refer to www.meanwell.com for detail spec.)



Model No.	HEP-100	HEP-150	HEP-185
AC input voltage range	85~264VAC, 120~370VDC		
AC inrush current (max.)	Cold start, 60A at 230VAC	Cold start, 65A at 230VAC	Cold start, 65A at 230VAC
DC adjustment range	Vo: -10%~+10% by VR (A-Type only) Io: 60%~100% of rated output current adjustment by VR(A-Type only)		Vo: -10%~+10% by VR(A-Type only) Io: 50%~100% of rated output current by VR(A-Type only)
Overload protection	105%~125% constant current limiting, auto-recovery		
Over voltage protection	108%~135% rated output voltage		
Setup, rise, hold up time	500ms, 50ms, 16ms at full load and 230VAC		
Withstand voltage	I/P-O/P: 3.75kVAC, I/P-FG: 2kVAC, O/P-FG: 1.5kVAC		
Working temperature	-55~+70°C (refer to output derating curve)		
Safety standards	UL62368-1, EAC TP TC 004 approved		
EMC standards	BS EN/EN55032 class B, EN61000-3-2,3, EN61000-4-2,3,4,5,6,8,11, EAC TP TC 020		
Connection	Input	UL rated, SJTW 18AWGx3C(30cm)	
	Output	SJTW 14AWGx2C(30cm)	
Dimension (LxWxH)(mm)	220x 68x 38.8	228x 68x 38.8	228x 68x 38.8

100W HEP-100

Model No.	Output	Tol.	R&N	Effi.
HEP-100-12[A]	12V, 0~8.34A	±2.0%	120mV	92%
HEP-100-15[A]	15V, 0~6.67A	±1.5%	150mV	92%
HEP-100-24[A]	24V, 0~4.00A	±1.0%	150mV	93%
HEP-100-36[A]	36V, 0~2.65A	±1.0%	200mV	93%
HEP-100-48[A]	48V, 0~2.00A	±1.0%	200mV	93%
HEP-100-54[A]	54V, 0~1.77A	±1.0%	200mV	93%

□ = A or Blank, A: standard model(IP65), Blank: optional model(IP68)

150W HEP-150

Model No.	Output	Tol.	R&N	Effi.
HEP-150-12[A]	12V, 0~12.5A	±2.5%	150mV	91.5%
HEP-150-15[A]	15V, 0~10.0A	±2.0%	150mV	92.0%
HEP-150-24[A]	24V, 0~6.30A	±1.0%	150mV	93.0%

Model No.	Output	Tol.	R&N	Effi.
HEP-150-36[A]	36V, 0~4.20A	±1.0%	200mV	93.5%
HEP-150-48[A]	48V, 0~3.20A	±1.0%	200mV	94.0%
HEP-150-54[A]	54V, 0~2.80A	±1.0%	200mV	94.0%

□ = A or Blank, A: standard model(IP65), Blank: optional model(IP68)

185W HEP-185

Model No.	Output	Tol.	R&N	Effi.
HEP-185-12[A]	12V, 0~13.0A	±2.5%	150mV	91.5%
HEP-185-15[A]	15V, 0~11.5A	±2.0%	150mV	92.0%
HEP-185-24[A]	24V, 0~7.80A	±1.0%	150mV	93.5%
HEP-185-36[A]	36V, 0~5.20A	±1.0%	200mV	93.5%
HEP-185-48[A]	48V, 0~3.90A	±1.0%	200mV	94.0%
HEP-185-54[A]	54V, 0~3.45A	±1.0%	200mV	94.0%

□ = A or Blank, A: standard model(IP65), Blank: optional model(IP68)

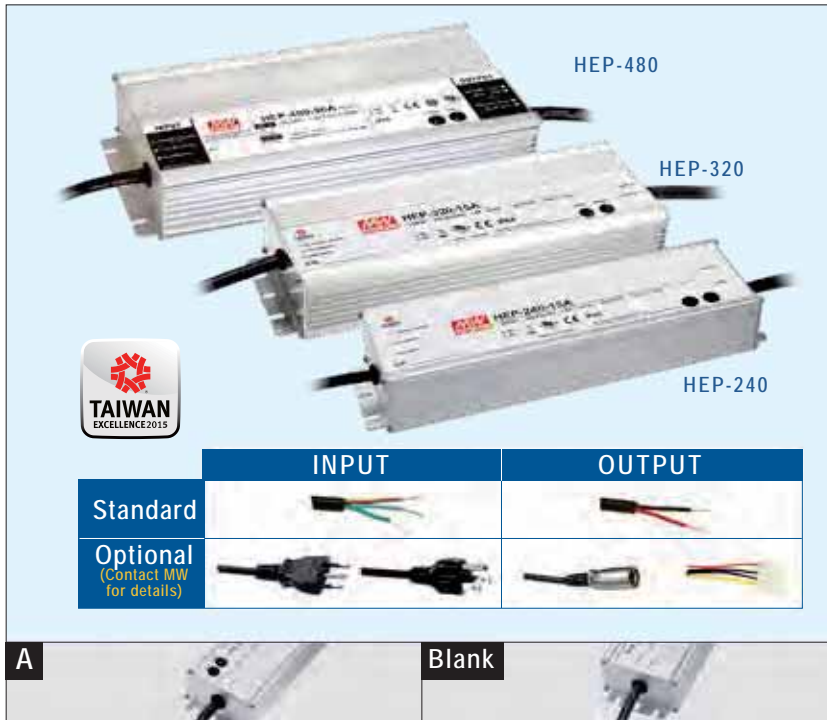

Features

- Universal AC input **90~305VAC**
- High efficiency up to **95%**
- **Fanless design**, cooling by free air convection
- **Ultra-wide operating temperature**
- Meet **6kV** surge immunity level
- Withstand **10G** vibration test
- Operating altitude up to **5000** meters
- Protections: Short circuit / Overload / Over voltage / Over temperature
- Multiple models for choice:
 - A-Type: **IP65 rated**, Vo and Io can be adjusted through internal potentiometer
 - Blank-Type(option): **IP68 rated**, Vo and Io fixed
- Suitable for general industrial applications at high/low temperature, high dust, high moisture, high vibration, high salt or outdoor environment
- **6 years warranty**

IP68 IP65



General Specification (Please refer to www.meanwell.com for detail spec.)

Model No.	HEP-240	HEP-320	HEP-480
AC input voltage range	85~264VAC, 120~370VDC		
AC inrush current (max.)	Cold start, 75A at 230VAC	Cold start, 70A at 230VAC	Cold start, 35A at 230VAC
DC adjustment range	Vo: -6%~+6% by VR (HEP-240 A-Type only) Io: 50%~100% of rated output current by VR (A-Type only)	Vo: -10%~+10% by VR (HEP-320 A-Type only) Io: 50%~100% of rated output current by VR (A-Type only)	Vo: -15%~+5% by VR Io: 50%~100% of rated output current by VR
Overload protection	105%~125% hiccup mode, auto-recovery		105%~125% constant current limiting, auto-recovery
Over voltage protection	108%~135% rated output voltage		
Setup, rise, hold up time	500ms, 80ms, 15ms at full load and 230VAC		500ms, 80ms, 16ms at full load and 230VAC
Withstand voltage	I/P-O/P: 3.75kVAC, I/P-FG: 2kVAC, O/P-FG: 1.5kVAC		
Working temperature	-55~+70°C (refer to output derating curve)		-55~+65°C (refer to output derating curve)
Safety standards	UL62368-1, EAC TP TC 004 approved		
EMC standards	BS EN/EN55032 class B, EN61000-3-2,3, EN61000-4-2,3,4,5,6,8,11, EAC TP TC 020		
Connection	Input	UL rated, SJTW 18AWGx3C (30cm)	
	Output	SJTW 14AWGx2C (30cm)	
Dimension (LxWxH)(mm)	244.2x 68x 38.8	252x 90x 43.8	262x 125x 43.8

240W HEP-240

Model No.	Output	Tol.	R&N	Effi.
HEP-240-12[A]	12V, 0~16.0A	±2.5%	150mV	90.0%
HEP-240-15[A]	15V, 0~15.0A	±2.0%	150mV	90.0%
HEP-240-24[A]	24V, 0~10.0A	±1.0%	150mV	92.5%
HEP-240-36[A]	36V, 0~6.70A	±1.0%	250mV	92.5%
HEP-240-48[A]	48V, 0~5.00A	±1.0%	250mV	93.0%
HEP-240-54[A]	54V, 0~4.45A	±1.0%	350mV	93.5%

□ = A or Blank, A: standard model(IP65), Blank: optional model(IP68)

320W HEP-320

Model No.	Output	Tol.	R&N	Effi.
HEP-320-12[A]	12V, 0~22.0A	±3.0%	150mV	91.0%
HEP-320-15[A]	15V, 0~19.0A	±2.0%	150mV	92.5%

Model No.	Output	Tol.	R&N	Effi.
HEP-320-24[A]	24V, 0~13.34A	±1.0%	150mV	94.0%
HEP-320-36[A]	36V, 0~8.90A	±1.0%	250mV	94.0%
HEP-320-48[A]	48V, 0~6.70A	±1.0%	250mV	94.5%
HEP-320-54[A]	54V, 0~5.95A	±1.0%	350mV	95.0%

□ = A or Blank, A: standard model(IP65), Blank: optional model(IP68)

480W HEP-480

Model No.	Output	Tol.	R&N	Effi.
HEP-480-24[A]	24V, 0~20A	±1.0%	200mV	94.0%
HEP-480-36[A]	36V, 0~13.3A	±1.0%	250mV	95.0%
HEP-480-48[A]	48V, 0~10A	±1.0%	250mV	94.5%
HEP-480-54[A]	54V, 0~8.9A	±1.0%	350mV	95.0%

□ = A or Blank, A: standard model(IP65), Blank: optional model(IP68)



Features

- Universal AC input **90~305VAC**
- Built-in active PFC function
- No load power consumption <0.5W at remote OFF (HEP-600)
- High efficiency up to **96%**
- **Fanless design**, cooling by free air convection
- **Ultra-wide operating temperature**
- Withstand **10G** vibration test
- Operating altitude up to **5000** meters
- Protections: Short circuit / Overload / Over voltage / Over temperature
- **Vo and Io can be adjusted through internal potentiometer**
- Suitable for general industrial applications at high/low temperature, high dust, high moisture, high vibration, high salt or outdoor environment
- **Built-in PMBus protocol/ optional CANBus protocol (HEP-1000)**
- **Output voltage and current programmable(HEP-1000)**
- Wiring type with IP67 rating (HEP-1000-W)
- **6 years warranty**

IP67 **PMBUS**
(HEP-1000)



General Specification (Please refer to www.meanwell.com for detail spec.)

Model No.	HEP-600	HEP-1000
AC input voltage range	85~264VAC, 120~370VDC	90~305VAC; 250~431VDC
AC inrush current (max.)	Cold start, 70A at 230VAC	Cold start, 40A at 230VAC
DC adjustment range	Vo: -15%~+5% by potentiometer Io: 50%~100% of rated output current by VR	Vo: 0%~+25% by VR
Overload protection	105%~125% constant current limiting, auto-recovery	
Over voltage protection	108%~135% rated output voltage	125%~145% rated output voltage
Setup, rise, hold up time	500ms, 80ms, 15ms at full load and 230VAC	1800ms, 80ms, 12ms at full load and 230VAC
Withstand voltage	I/P-O/P: 3.75kVAC, I/P-FG: 2kVAC, O/P-FG: 1.5kVAC	I/P-O/P: 3kVAC, I/P-FG: 2kVAC, O/P-FG: 1.25kVAC
Working temperature	-40~+70°C (refer to output derating curve)	
Safety standards	UL62368-1, TUV BS EN/EN62368-1, EAC TP TC 004 approved	UL62368-1, TUV BS EN/EN62368-1, EAC TP TC 004 approved; design refer to EN61558-1, EN60335-1(by request)
EMC standards	BS EN/EN55032 class B, EN61000-3-2,3, EN61000-4-2,3,4,5,6,8,11, EAC TP TC 020	
Connection	Input Output	3+7P / 11mm pitch terminal block with cover
Dimension (LxWxH)(mm)	280x 144x 48.5	
	3+4P / 11mm pitch terminal block with cover	
	310x 144x 48.5	

600W

HEP-600

Model No.	Output	Tol.	R&N	Effi.
HEP-600-12	12V, 0~40A	±3.0%	150mV	93.0%
HEP-600-15	15V, 0~36A	±2.0%	150mV	94.0%
HEP-600-20	20V, 0~28A	±1.5%	150mV	95.0%
HEP-600-24	24V, 0~25A	±1.0%	150mV	95.0%
HEP-600-30	30V, 0~20A	±1.0%	200mV	95.5%
HEP-600-36	36V, 0~16.7A	±1.0%	250mV	95.5%
HEP-600-42	42V, 0~14.3A	±1.0%	250mV	96.0%

Model No.	Output	Tol.	R&N	Effi.
HEP-600-48	48V, 0~12.5A	±1.0%	250mV	96.0%
HEP-600-54	54V, 0~11.2A	±1.0%	350mV	96.0%

1000W

HEP-1000

Model No.	Output	Tol.	R&N	Effi.
HEP-1000 24 <input type="checkbox"/>	24V, 0~42A	±1.0%	200mV	95%
HEP-1000-48 <input type="checkbox"/>	48V, 0~21A	±1.0%	250mV	96%
HEP-1000-100 <input type="checkbox"/>	100V, 0~10A	±1.0%	500mV	96%

= Blank or W; Blank:terminal type, W: wiring type with IP67

HEP-1000 Series functions

Option	Function type	Supply function	Carrier function	Voltage range	Module	Control	LED indicator	Remote On/Off	DC Output	Temperature Compensation	12V0 output
Terminal type											
Wiring type											

Security Series 240~480W All-In-One Security Power

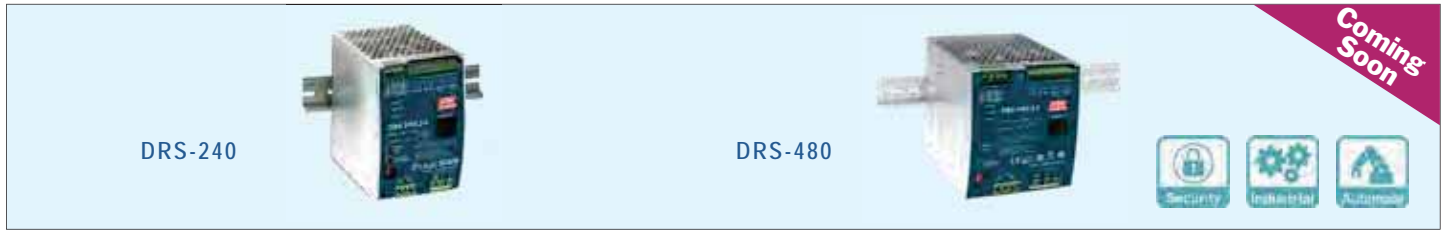

Features

- All-in-one function with Power supply, DC-UPS, battery charger and status monitoring in ONE compact unit
- Universal input 90~305VAC (277VAC available)
- From C relay contacts and LED indicator for AC fail, bat low, Charger Circuit fail, DC OK
- Built-in MODBUS protocol, CANBus optional
- Charging curve can be set with SBP-001(see page97)
- 20~100% charging current adjustable by VR
- 2 or 3-stage selectable by DIP S.W, suitable for lead acid and li-ion batteries
- Load-dependent high speed battery charging
- Proections: OLP/OTP/OVP/BAT cut off/ BAT reverse polarity(NO damage)
- -30~+70 wide operating temp
- Signal and alarms design meet UL2524,NFPA 1221 ,BS EN/EN54-4 and GB17945 requirement
- 3 years warranty

General Specification (Please refer to www.meanwell.com for detail spec.)



Model No.	DRS-240	DRS-480	
AC input voltage range	90~305VAC; 127~431VDC		
Total O/P Power	Combined power on all channels 240W (DRS-240)/480W(DRS-480)		
Withstand voltage	I/P-O/P:4kVAC I/P-FG:2kVAC O/P-FG:1.5kVAC		
Working temperature	-30~+70°C (refer to output derating curve)		
Safety standards	UL62368-1, DEKRA BS EN/EN62368-1, EAC TP TC004 approved		
EMC standards	BS EN/EN55032 class B, EN61000-4-2,3,4,5,6,8; BS EN/EN54-4 for fire and fire alarm system		
Functions	From-C Relay	AC fail	Signals AC failure and activates when input voltage drops below:85~90% of 120Vac , 60~85% of 220Vac
		charger circuit fail	Relay contact, Relay ON:DC OK, Relay OFF:charger fail
		DC OK	Signals normal DC output and activates when output voltage>90% rated
		Bot.low/ Abnormal/ Disconnected	Relay contact, Relay ON:Bat. OK, Relay OFF:Bat.low BAT.low voltage:<11V, <22V, <33V, <44V
	BAT.start	Restart system directly form bat.and does not require AC power	
	Charging current Adj.	20~100% charging current adjustable by VR	
	DC UPS	UPS switch to bat. within 10ms of AC failure	
	Communication	Built-in MODBUS protocol,CANBus optional	
Dimension (WxHxD)(mm)	85.5x 125.2x 128.5	110x 125.2x 150	

240W DRS-240

Model No.	Output	Tol.	R&N	Effi.
DRS-240-12	12V,0~20A	±1%	120mV	92%
DRS-240-24	24V,0~10A	±1%	240mV	93%
DRS-240-36	36V,0~6.6A	±1%	360mV	94%
DRS-240-48	48V,0~5A	±1%	480mV	94%

480W DRS-480

Model No.	Output	Tol.	R&N	Effi.
DRS-480-24	24V,0~20A	±1%	240mV	93%
DRS-480-36	36V,0~13.3A	±1%	360mV	94%
DRS-480-48	48V,0~10A	±1%	480mV	94%

DRS Series Example of Application

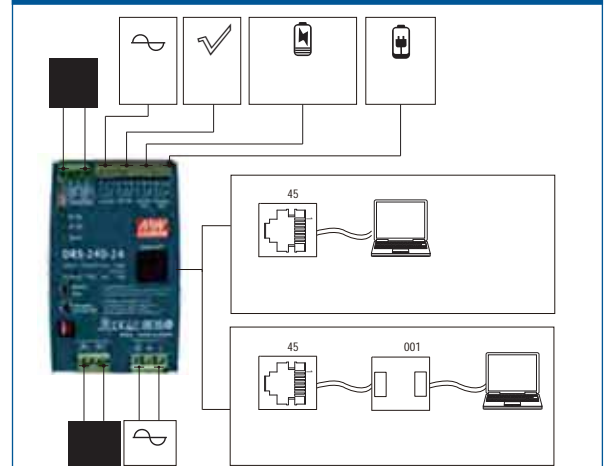

Security Series 40~60W Single Output with Battery Charger



■ Features

- Single output with built-in battery charger circuit (UPS function)
- Universal AC input / Full range
- Can be installed on DIN rail
TS-35/7.5 or 15
- Protections:
Short circuit / Overload / Over voltage / Battery low protection /
Battery reverse polarity protection by fuse
- Alarm signal for AC OK and battery low via RELAY Contact
- Pass LPS
- LED indicator for power on
- 3 years warranty

■ General Specification (Please refer to www.meanwell.com for detail spec.)



Model No.	DRC-40	DRC-60
AC input voltage range	90~264VAC; 127~370VDC	
AC inrush current (max.)	Cold start, 30A at 115VAC, 60A at 230VAC	
DC adjustment range	CH1, 13.8V: 12~15V; 27.6V: 24~30V	
Overload protection	105%~150% hiccup mode, auto-recovery	
Over voltage protection	105%~135% rated output voltage	
Setup, rise, hold up time	400ms, 50ms, 50ms at full load and 230VAC	
Withstand voltage	I/P-O/P: 3kVAC, I/P-FG: 2kVAC, O/P-FG: 0.5kVAC	
Working temperature	-30~+70°C (refer to output derating curve)	
Safety standards	UL62368-1, TUV BS EN/EN62368-1, EAC TP TC 004, AS/NZS62368.1 approved	
EMC standards	BS EN/EN55032 class B, EN61000-3-2,3, EN61000-4-2,3,4,5,6,8,11, EAC TP TC 020	
Connection (screw DIN terminal)	I/P: 3 poles, O/P: 8 poles	
Dimension (LxWxH)(mm)	40x 90x 100	

■ 40W DRC-40

Model No.	Output	Tol.	R&N	Effi.	Max.
DRC-40A	13.8V, 0~2.9A	±1%	120mV	86%	40W
	13.8V, 0~1.0A (Charger)				
DRC-40B	27.6V, 0~1.45A	±1%	200mV	87%	40W
	27.6V, 0~0.5A (Charger)				

■ 60W DRC-60

Model No.	Output	Tol.	R&N	Effi.	Max.
DRC-60A	13.8V, 0~4.3A	±1%	120mV	86%	59W
	13.8V, 0~1.5A (Charger)				
DRC-60B	27.6V, 0~2.15A	±1%	200mV	88%	59W
	27.6V, 0~0.75A (Charger)				

DRC Serie Example of Application

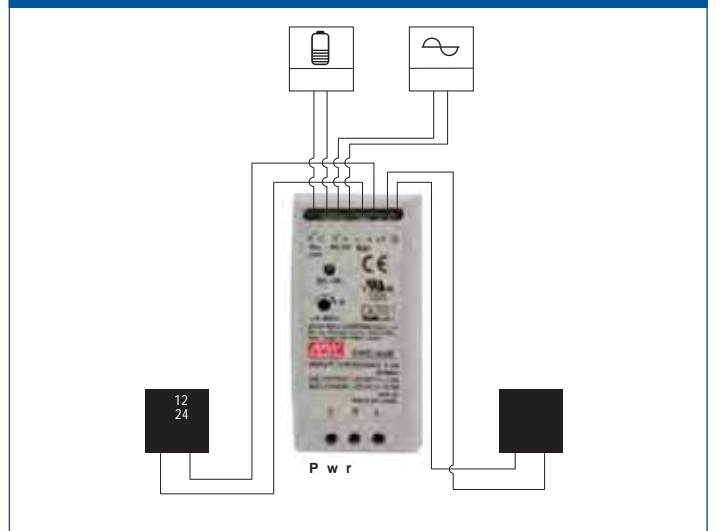



Features

- Single output with built-in battery charger circuit (UPS function)
- Universal AC input / Full range
- Can be installed on DIN rail TS-35/7.5 or 15
- Protections: Short circuit / Overload / Over voltage / Battery low protection / Battery reverse polarity protection by fuse
- Alarm signal for AC OK and battery low via RELAY contact
- Fanless design
- LED indicator for power on
- 3 years warranty

General Specification (Please refer to www.meanwell.com for detail spec.)



Model No.	DRC-100	DRC-180
AC input voltage range	90~264VAC; 127~370VDC	
AC inrush current (max.)	Cold start, 30A at 115VAC, 60A at 230VAC	Cold start, 35A at 115VAC, 70A at 230VAC
DC adjustment range	CH1, 13.8V: 12~15V; 27.6V:24~30V	CH1:13.8V:12~15V; 27.6V:24~29V
Overload protection	105%~150% hiccup mode, auto-recovery	
Over voltage protection	105%~135% rated output voltage	
Setup, rise, hold up time	2400ms, 50ms, 50ms at full load and 230VAC	2000ms, 20ms, 20ms at full load and 230VAC
Withstand voltage	I/P-O/P:3kVAC, I/P-FG: 2kVAC, O/P-FG: 0.5kVAC	
Working temperature	-30~+70°C (refer to output derating curve)	-20~+70°C (refer to output derating curve)
Safety standards	UL62368-1, TUV BS EN/EN62368-1, EAC TP TC 004, AS/NZS62368.1 approved	
EMC standards	BS EN/EN55032 class B, EN61000-3-2,3, EN61000-4-2,3,4,5,6,8,11, EAC TP TC 020	
Connection (screw DIN terminal)	I/P:3 poles, O/P: 10 poles	I/P:3 poles, O/P:8 poles
Dimension (LxWxH)(mm)	55x 90x 100	63x 125.2x 113.5

100W DRC-100

Model No.	Output	Tol.	R&N	Effi.	Max.
DRC-100A	13.8V, 0~7A 13.8V, 0~2.5A (Charger)	±1%	120mV	87%	97W
DRC-100B	27.6V, 0~3.5A 27.6V, 0~1.25A (Charger)	±1%	240mV	89%	97W

180W Coming Soon DRC-180

Model No.	Output	Tol.	R&N	Effi.	Max.
DRC-180A	13.8V, 0~9A 13.8V, 0~4A (Charger)	±1%	150mV	88%	180W
DRC-180B	27.6V, 0~4.5A 27.6V, 0~2A (Charger)	±1%	240mV	90%	180W

Function	Description	Output Alarm
CO		
Battery Lo	11 22	
	11 22	

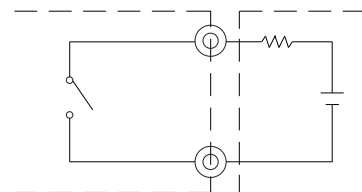

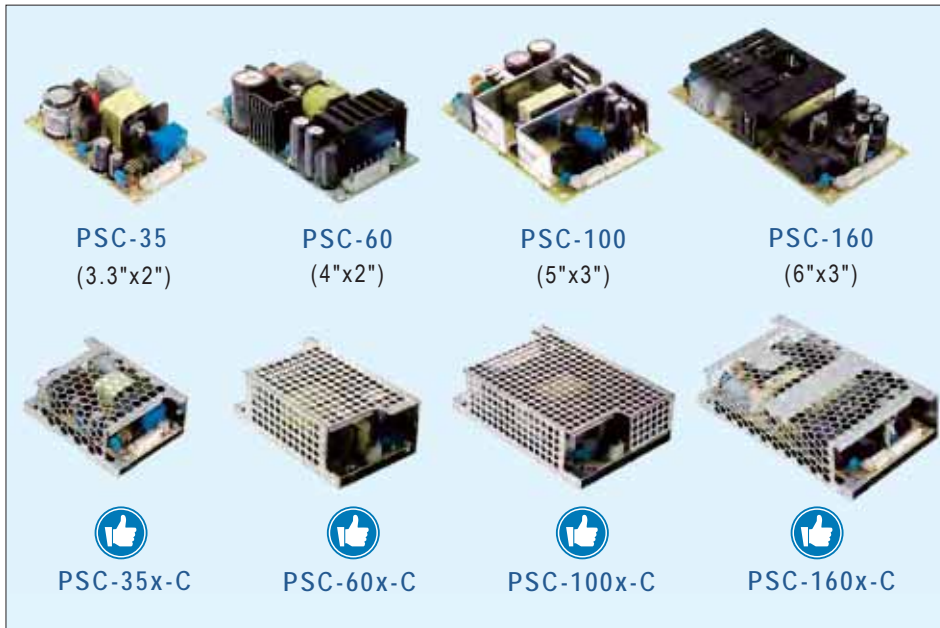

Features

- Single output with built-in battery charger circuit (UPS function)
- Universal AC input / Full range
- PCB and enclosed type with metal case available
- Compact size
- Protections: Short circuit / Overload / Over voltage
- Battery low protection / Battery reverse polarity protection by fuse
- Alarm signal for AC OK and battery low via RELAY contac
- Fanless design
- 100% full load, burn-in test
- 2 years warranty

General Specification (Please refer to www.meanwell.com for detail spec.)



Model No.	PSC-35 <input type="checkbox"/>	PSC-60 <input type="checkbox"/>	PSC-100 <input type="checkbox"/>	PSC-160 <input type="checkbox"/>	
AC input voltage range	90~264VAC; 127~370VDC				
AC inrush current (max.)	Cold start, 40A at 230VAC		60A at 230VAC	70A at 230VAC	
DC adjustment range	CH1, 13.8V: 12~15V; 27.6V: 24~29V				
Overload protection	105%~150% hiccup mode, auto-recovery				
Over voltage protection	CH1, 105%~135%, shut off, re-power on to recover		CH1, 105%~135%, hiccup mode, auto recovery	CH1, 105%~135%, shut off, re-power on to recover	
Withstand voltage	I/P-O/P:3kVAC, I/P-FG: 2kVAC, O/P-FG:0.5kVAC				
Working temperature	-30~+70°C (refer to output derating curve)		-20~+70°C (refer to output derating curve)		
Safety standards	UL62368-1, TUV BS EN/EN62368-1, EAC TP TC 004 approved				
EMC standards	BS EN/EN55032 class B, EN61000-3-2,3, EN61000-4-2,3,4,5,6,8,11, EAC TP TC 020				
Connection	3+6P/3.96mm pitch, JST: B3P/B6P-VH			3+8P/3.96mm pitch, 4P/2.5mm pitch, JST: B3P/B8P-VH, B4B-XH	
Dimension (LxWxH)(mm)	PCB Type	84.6x 50.8x 24	101.6x 50.8x 29	127x 76.2x 31	152.4x 76.2x 32
	Enclosed Type	86.4x 59.6x 30	103.4x 62x 37	130x 85x 37	155.4x 85x 37

35W PSC-35

Model No.	Output	Tol.	R&N	Effi.	Max.
PSC-35A <input type="checkbox"/>	13.8V, 0~2.6A	±1%	120mV	84%	36W
	13.8V, 0~0.9A (Charger)				
PSC-35B <input type="checkbox"/>	27.6V, 0~1.3A	±1%	240mV	86%	36W
	27.6V, 0~0.45A (Charger)				

= blank, -C ; Blank: PCB Type, -C: Enclosed Type

100W PSC-100

Model No.	Output	Tol.	R&N	Effi.	Max.
PSC-100A <input type="checkbox"/>	13.8V, 0~7.0A	±1%	100mV	86%	100W
	13.8V, 0~2.5A (Charger)				
PSC-100B <input type="checkbox"/>	27.6V, 0~3.50A	±1%	100mV	88%	100W
	27.6V, 0~1.25A (Charger)				

= blank, -C ; Blank: PCB Type, -C: Enclosed Type

60W PSC-60

Model No.	Output	Tol.	R&N	Effi.	Max.
PSC-60A <input type="checkbox"/>	13.8V, 0~4.3A	±1%	120mV	84%	59W
	13.8V, 0~1.50A (Charger)				
PSC-60B <input type="checkbox"/>	27.6V, 0~2.15A	±1%	240mV	84%	59W
	27.6V, 0~0.75A (Charger)				

= blank, -C ; Blank: PCB Type, -C: Enclosed Type

160W PSC-160

Model No.	Output	Tol.	R&N	Effi.	Max.
PSC-160A <input type="checkbox"/>	13.8V, 0~11.6A	±1%	150mV	88%	160W
	13.8V, 0~4A (Charger)				
PSC-160B <input type="checkbox"/>	27.6V, 0~5.8A	±1%	240mV	90%	160W
	27.6V, 0~2A (Charger)				

= blank, -C ; Blank: PCB Type, -C: Enclosed Type

Security Series 55~155W Single and Dual Output

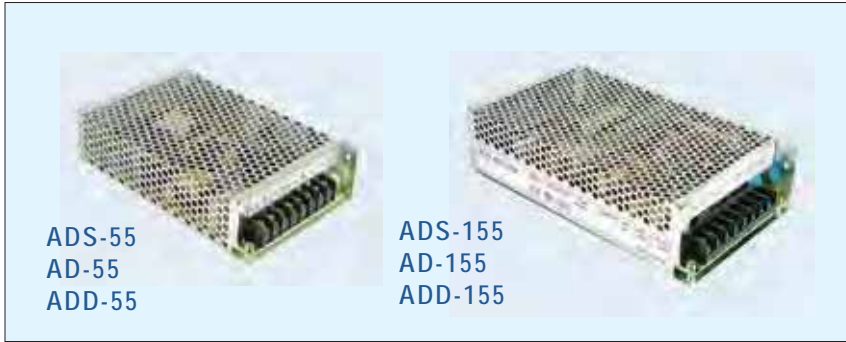

ADS-55
AD-55
ADD-55

ADS-155
AD-155
ADD-155

Features

- Universal AC input / Full range
- PF>0.92@230VAC and full load (155W only)
- Protections:
Short circuit / Overload / Over voltage
- Battery low protection (except for ADS series)
- Fanless design
- 2 years warranty

General Specification (Please refer to www.meanwell.com for detail spec.)



Model No.	ADS-55	AD-55	ADD-55	ADS-155	AD-155	ADD-155
AC input voltage range	88~264VAC; 124~370VDC					
AC inrush current	Cold start, 23A at 115VAC, 45A at 230VAC					
DC adjustment range	12V, 24V, 48V: $\pm 10\%$; 13.8V: 12~14.5V; 27.6V: 24~29V; 54V: 48~58V					
Overload protection	CH1,2: 105%~135%, charger: 0.51~0.9A; constant current limiting, auto-recovery					
Over voltage protection	CH1: 115%~135% rated output voltage					
Setup, rise, hold up time	1000ms, 90ms, 24ms at full load and 230VAC					
Withstand voltage	I/P-O/P:3kVAC, I/P-FG:2kVAC, O/P-FG: 0.5kVAC					
Working temperature	-10~+60°C (refer to output derating curve)					
Safety standards	UL62368-1, TUV BS EN/EN62368-1, EAC TP TC 004 approved					
EMC standards	BS EN/EN55032 class B, EN61000-3-2,3, EN61000-4-2,3,4,5,6,8,11, EAC TP TC 020					
Connection	8P/ 9.5mm pitch terminal block					
Dimension (LxWxH)(mm)	159x 97x 38			199x 110x 50		

Single Output with 5V/4A DC-DC Converter ADS-55

Model No.	Output	Tol.	R&N	Effi.	Max.
ADS-5512	12V, 0~4.0A	$\pm 1\%$	100mV	76%	51W
	5V, 0~4.0A	$\pm 3\%$	100mV		
ADS-5524	24V, 0~2.5A	$\pm 1\%$	100mV	79%	58W
	5V, 0~4.0A	$\pm 3\%$	100mV		

Single Output with Battery Charger(UPS Function) AD-55

Model No.	Output	Tol.	R&N	Effi.	Max.
AD-55A	13.8V, 0~4.0A	$\pm 1\%$	100mV	71%	51W
	13.4V, 0~0.23A (Charger)				
AD-55B	27.6V, 0~2.0A	$\pm 1\%$	100mV	74%	54W
	26.5V, 0~0.16A (Charger)				

Dual Output with Battery Charger(UPS Function) ADD-55

Model No.	Output	Tol.	R&N	Effi.	Max.
ADD-55A	13.8V, 0~3.50A	$\pm 1\%$	100mV	71%	53W
	5V, 0~4.00A	$\pm 3\%$	100mV		
	13.4V, 0~0.23A (Charger)				
ADD-55B	27.6V, 0~2.00A	$\pm 1\%$	150mV	74%	55W
	5V, 0~4.00A	$\pm 3\%$	150mV		
	26.5V, 0~0.16A (Charger)				

Single Output with 5V/3A DC-DC Converter ADS-155

Model No.	Output	Tol.	R&N	Effi.	Max.
ADS-15512	12V, 0~12.5A	$\pm 2\%$	150mV	77%	153W
	5V, 0~3.00A	$\pm 3\%$	100mV		
ADS-15524	24V, 0~6.50A	$\pm 1\%$	150mV	82%	154W
	5V, 0~3.00A	$\pm 3\%$	100mV		
ADS-15548	48V, 0~3.20A	$\pm 1\%$	240mV	82%	154W
	5V, 0~3.00A	$\pm 5\%$	100mV		

Single Output with Battery Charger(UPS Function) AD-155

Model No.	Output	Tol.	R&N	Effi.	Max.
AD-155A	13.8V, 0~11.5A	$\pm 2\%$	150mV	80%	152W
	13.3V, 0~0.50A (Charger)				
AD-155B	27.6V, 0~5.50A	$\pm 1\%$	150mV	84%	152W
	27.1V, 0~0.50A (Charger)				
AD-155C	54.0V, 0~2.70A	$\pm 1\%$	240mV	84%	157W
	53.5V, 0~0.50A (Charger)				

Dual Output with Battery Charger(UPS Function) ADD-155

Model No.	Output	Tol.	R&N	Effi.	Max.
ADD-155A	13.8V, 0~10.5A	$\pm 1\%$	150mV	78%	153W
	5V, 0~3.00A	$\pm 3\%$	100mV		
	13.3V, 0~0.50A (Charger)				
ADD-155B	27.6V, 0~5.00A	$\pm 1\%$	200mV	81%	153W
	5V, 0~3.00A	$\pm 3\%$	100mV		
	27.1V, 0~0.50A (Charger)				
ADD-155C	54.0V, 0~2.50A	$\pm 1\%$	240mV	81%	150W
	5V, 0~3.00A	$\pm 5\%$	100mV		
	53.5V, 0~0.20A (Charger)				

Block Diagram

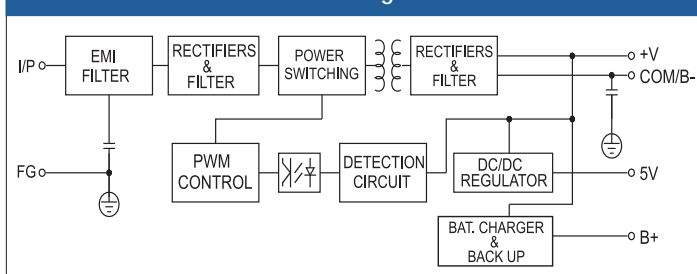



Features

- Universal AC input / Full range
- Protections: Short circuit / Overload / Over voltage / Battery reverse polarity protection by fuse
- Fanless design
- No load power consumption <0.75W
- Suitable for installation in metallic or non-metallic system enclosure
- **Temperature compensation function**
- LED indicator for power on
- 2 years warranty

General Specification (Please refer to www.meanwell.com for detail spec.)



Model No.	SCP-35	SCP-50	SCP-75
AC input voltage range	85~264VAC; 120~370VDC		
DC adjustment range	95%~115% rated output voltage		
Overload protection	120%~165%, hiccup mode, auto-recovery		
Over voltage protection	120%~140%, rated output voltage		
Withstand voltage	I/P-O/P: 3kVAC, I/P-FG:2kVAC, 1minute		
Working temperature	-20~+60°C (refer to output derating curve)		
Safety standards	UL62368-1, EAC TP TC 004 approved		
EMC standards	BS EN/EN55032 class B, EN61000-3-2,3, EN61000-4-2,3,4,5,6,8,11, EAC TP TC 020		
Connection	I/P: 3 poles, O/P: 2 poles screw terminal		
Dimension (LxWxH)(mm)	99x 97x 36	129x 98x 38	159x 97x 38

35W SCP-35

Model No.	Output	Tol.	R&N	Effi.	Max.
SCP-35-12	13.8V, 0~2.6A	±2%	120mV	83%	35W
SCP-35-24	27.6V, 0~1.4A	±1%	200mV	86%	35W

50W SCP-50

Model No.	Output	Tol.	R&N	Effi.	Max.
SCP-50-24	27.6V, 0~1.8A	±1%	200mV	85%	50W

50W SCP-50

Model No.	Output	Tol.	R&N	Effi.	Max.
SCP-50-12	13.8V, 0~3.6A	±2%	120mV	81%	50W

75W SCP-75

Model No.	Output	Tol.	R&N	Effi.	Max.
SCP-75-12	13.8V, 0~5.4A	±2%	120mV	80%	75W
SCP-75-24	27.6V, 0~2.7A	±1%	200mV	84%	75W

Series	Difference	Product Level	Mounting Style	Watt.	Functions							Working Temp.	WTY (years)		
					Built-in Charger	AC OK	DC OK	Bat Low	Bat. Abnormal or Disconnected	UPS	Communication Interface			Charging Curve Adj.	
SCP		Basic	Screw Mounted	35W 50W 75W	×	×	×	×	×	×	×	×	-20~+60	2	
AD/ADD/ADS	55W 155W			√ (AD/ADD)	×	×	×	×	×	×	×	-10~+60			
PSC-C		Advanced	Screw Mounted	35W 60W 100W 160W	√	√ (TTL)	×	√ (TTL)	×	√	×	×	-30~+70		3
PSC				40W 60W 100W 180W	√	√ (TTL)	×	√ (TTL)	×	√	×	×			
DRC		DIN Rail	240W 480W	√	√ (RELAY)	√ (RELAY)	√ (RELAY)	√ (RELAY)	×	√	MODBus (standard) CANBus (option)	√			
DRS		Intelligent and All-in-one													



Features

- EIB / KNX power supply with **Integrated choke**
- Compact size with 3SU/4SU width
- Safety extra low voltage (**SELV**)
- 180~264VAC input
- No load power consumption <0.5W
- Protections: Short circuit / Overload(short-circuit-proof) / Over voltage
- Cooling by free air convection
- Support both **TP1-64 and new TP1-256 topology**, reduce the usage of line repeater
- Isolation class I
- LED indicator for normal operation, bus reset and bus overload
- Installed on DIN rail TS-35/7.5 or 15
- **Over voltage category III**
- Wide operating temperature: -30~+70°C
- 3 years warranty

General Specification (Please refer to www.meanwell.com for detail spec.)



Model No.	KNX-20E-640	KNX-40E-1280 <input type="checkbox"/>
AC input voltage range	180~264VAC; 230~370VDC	180~264VAC; 176~280VDC
AC inrush current (max.)	Cold start, 40A at 230VAC	Cold start, 60A at 230VAC
LED indicators	ON: Green LED, normal operation, no fault; Reset: Red LED, reset of the KNX bus; I _{out} > I _{max} : Red LED, KNX bus overload; KNX-40E-1280D please refer to spec.	
Overload protection	Range	205%~235% rated output power
	Type	constant current limiting, auto-recovery after fault condition is removed
Over voltage protection	Range	33~35V
	Type	Shut down o/p voltage, re-power on to recover
Working temperature	-30~+70°C (refer to output derating curve)	
Safety standards	BS EN/EN61558-1,EN61558-2-16, EN50491-3, EAC TP TC 004 approved	
EMC standards	BS EN/EN50491-5-1,-5-2,-5-3, EN61000-4-2,3,4,5,6,8,11, EAC TP TC 020	
Connection (screw DIN terminal)	I/P: 3 poles; O/P: 2 poles screw DIN terminal & 2 KNX bus terminals (black/red)	
Dimension (WxHxD)(mm)	52.5x 90x 54.5	72x 90x 57

Model No.	V _{out1} (with choke)	V _{out2} (without choke)	I _{out} (I ₁ +I ₂)
KNX-20E-640	Bus, 30VDC	30VDC	640mA

Model No.	V _{out1} (with chock)	V _{out2} (without chock)	I _{out} (I ₁ +I ₂)
KNX-40E-1280 <input type="checkbox"/>	Bus, 30VDC	30VDC	1280mA

: Blank, D ; Blank= Basic function, D=Diagnostic function

▶ MEAN WELL also provide KNX lighting control solution, please check our standard LED driver catalog or visit our website <https://building.meanwell.com/>

Lighting Control	Stair Lighting Control	0-10V/1-10V Dimming	DALI Dimming	Smart Lighting Control
LED Lamp LED Driver	KNX Actuator	Dimmable LED Lamp LED Driver	DALI LED Lamp LED Driver	KNX LED Driver
KNX Dimming Actuator	KNX Dimming Actuator	KNX/DALI Gateway	KNX LED Driver	

KNX Universal Actuator

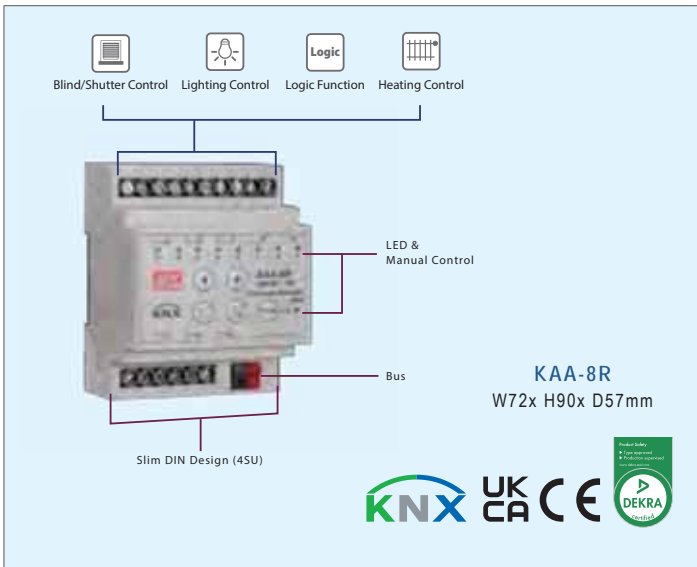

- 8 channel actuator in a compact size
- Suitable for various and mixed applications
- For AX, C-load, capacitive & inductive of loads
- **Capacitive load 220 μ F**
- Program via ETS5.0 software
- Manual control via Push button
- Programmable various time and scene function
- 3 years warranty

Model No.	Channel	Rating current / Channel
KAA-8R	8-Fold	16A
KAA-8R-10	8-Fold	10A

KNX Dimming Actuator

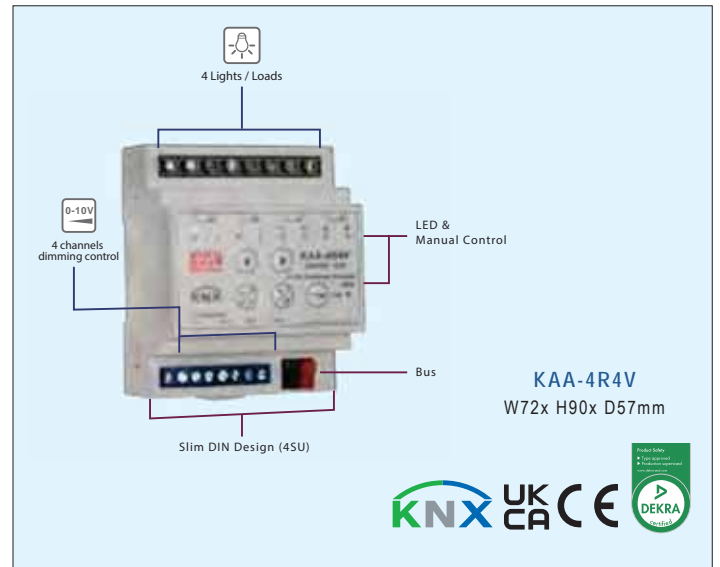

- Dimming and switching LED driver and conventional electronic ballast
- **Capacitive load 220 μ F**
- LED indicator for each channel
- Linear or logarithmic dimming curve programable via ETS software
- Manual control via Push button on panel
- Programmable various time and scene function
- 3 years warranty

Model No.	Channel	Rating current / Channel
KAA-4R4V(optional)	4-Fold	16A
KAA-4R4V-10	4-Fold	10A

Durability of KNX Actuator

All MEAN WELL KNX actuator has been tested more than standard to 220 μ F to ensure long term operation in the system. In case even higher demand is required, the inrush current limiter can be placed between KNX actuator and the loads to further increase the capacitive load to 2500 μ F.

Circuit Breaker **KNX Switching Actuator**
KAA-8R / KAA-4R4V Inrush Current Limiter
ICL-16R Capacitive Load
e.g. LED Driver

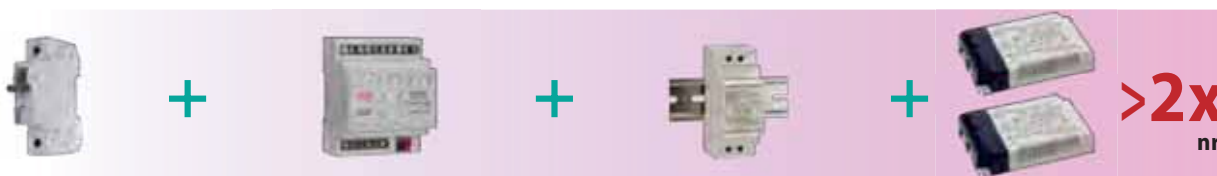

NOTE: The max. number connected load is no more limited by its inrush current.

LED Sign Panel

160~200W Slim Width and Low Profile



Features

- Universal AC input / Full range
- Withstand 300VAC surge input for 5 seconds
- Slim width and low profile
- Built-in active PFC function
- Built in current sharing (LSP-160)
- Fanless design, cooling by free air convection
- Protections: Short circuit / Overload / Over voltage / Over temp.
- DC OK signal
- LED indicator for power on (LSP-160 / UHP-200A)
- Suitable for moving sign applications
- 3 years warranty

General Specification (Please refer to www.meanwell.com for detail spec.)



Model No.	LSP-160	UHP-200A
AC input voltage range	100~264VAC; 141~370VDC	90~264VAC; 141~370VDC
Leakage current	<0.75mA / 240V	Less than 1mA at 240VAC
AC inrush current (max.)	Cold start, 85A at 230VAC	
DC adjustment range	3.2V: 3.2~3.5V, 4.2V:4~4.5V 5V: 4.7~5.3V	4.2V: 4.0~4.4V, 4.5V: 4.3~4.7V, 5V: 4.7~5.3V
Overload protection	110%~140% rated output power/	
Over voltage protection	3.8~6.75V shut down O/P	4.6~7.1V Shut down O/P
Setup, rise, hold up time	2000ms, 80ms, 10ms at 230VAC	2000ms, 200ms, 10ms at 230VAC
Withstand voltage	I/P-O/P:3.75KVAC, I/P-FG:2KVAC, O/P-FG:1.25KVAC	I/P-O/P:3kVAC, I/P-FG:2kVAC, O/P-F/G: 0.5kVDC
Working temperature	-30~+70°C (refer to output derating curve)	
Vibration	10~500Hz, 5G 10min. / 1 cycle, period for 60 min., each along X, Y, Z axes	
Safety standards	UL62368-1, TUV BS EN/EN62368-1, CCC GB4943, EAC TP TC 004, BSMI CNS14336-1 approved, Design refer to EN60335-1	UL62368-1, TUV BS EN/EN62368-1, CCC GB4943, EAC TP TC 004 approved
EMC standards	Compliance to BS EN/EN55032 / EN55035 GB9254, Class B, EN61000-3-2, -3, EAC TP TC 020	BS EN/EN55032 class B, EN61000-3-2,3, EN61000-4-2,3,4,5,6,8,11, EN55024, GB9254, GB17625.1, EAC TP TC 020
Dimension (LxWxH)(mm)	194x 55x 20	167x 55x 26

160W LSP-160

Model No.	Output	Tol.	R&N	Effi.
LSP-160□-3.3○	3.3V, 0~32A	±2%	200mV	87.5%
LSP-160□-4.2○	4.2V, 0~32A	±2%	200mV	88.5%
LSP-160□-5○	5V, 0~32A	±2%	200mV	89.5%
LSP-160-12○	12V, 0~13.5A	±1%	240mV	92.5%
LSP-160-24○	24V, 0~6.75A	±1%	240mV	93.5%
LSP-160-36○	36V, 0~4.5A	±1%	240mV	93.5%

Model No.	Output	Tol.	R&N	Effi.
LSP-160-48○	48V, 0~3.4A	±1%	300mV	93.5%

NOTE: Current sharing function available for < 5 V only
 □ = R with current sharing function
 ○ = T or W, T: For terminal block; W: For wafer connector

200W UHP-200A

Model No.	Output	Tol.	R&N	Effi.
UHP-200A-4.2	4.2V, 0~40A	±4%	200mV	88%
UHP-200A-4.5	4.5V, 0~40A	±4%	200mV	88%
UHP-200A-5	5V, 0~40A	±4%	200mV	88.5%



Features

- ERP-200/350: 180~264VAC input only
ERP-400: 90~264VAC input
(withstand 300VAC surge input for 5 sec.)
- Built-in active PFC function (ERPF-400)
- Semi-potted and design against rain splash
- Fanless design, cooling by free air convection
- Protections: Short circuit / Overload / Over voltage / Over temperature
- LED indicator for power on
- Low cost, high reliability
- Suitable for channel letter, strip lighting and moving sign applications
- 3 years warranty

General Specification (Please refer to www.meanwell.com for detail spec.)

Model No.	ERP-200	ERP-350	ERPF-400
AC input voltage range	180~264VAC; 254~370VDC		90~264VAC; 127~370VDC
AC inrush current (max.)	Cold start, 90A at 230VAC		
Setup, rise, hold up time	1500ms, 200ms, 20ms at 230VAC		2000ms, 100ms, 10ms at 230VAC
DC adjustment range	±10% rated output voltage		
Overload protection	Range	110%~140% rated output power	110%~180% rated output power
	Type	Hiccup mode, auto-recovery	
Over voltage protection	Range	12V: 13.8~16.2V, 24V: 27.6~32.4V	12V: 13.8~16.2V, 24V: 27.6~32.4V, 48V: 55.2~64.8V
	Type	Hiccup mode, auto-recovery	
Withstand voltage	I/P-O/P: 3kVAC, I/P-FG: 2kVAC, O/P-FG: 0.5kVAC		
Working temperature	-30~+60°C (refer to output derating curve)		
Safety standards	IEC/ BS EN/EN62368-1 / CQC GB4943.1(24V),EAC TP TC 004, IS13252(part I) approved	UL62368-1, GB4943.1, EAC TP TC004, IS13252 (part1)	UL62368-1, TUV BS EN/EN62368-1, CCC GB4943.1, EAC TP TC 004, IS13252(part I) approved
EMC standards	Design refer to BS EN/EN55032 class A, EAC TP TC 020, EN61000-4-5		Compliance to GB17625.1, BS EN/EN61000-3-3, EN61000-4-2,3,4,5,6,8,11, EN55032 class A, GB9254 class A, EAC TP TC020
Connection	Input	9P / 9.5mm pitch terminal block	
	Output		
Dimension (LxWxH) (mm)	200x 120x 40	220.4x 130x 48	

ERP-350 Series



Model No.	Output	Tol.	R&N	Effi.
ERP-350-12	12V, 0~26.7A	±1%	150mV	87%
ERP-350-24	24V, 0~14.6A	±1%	150mV	89%
ERP-350-36	36V, 0~9.7A	±1%	240mV	90%
ERP-350-48	48V, 0~7.3A	±1%	240mV	90%

ERP-200 Series



Model No.	Output	Tol.	R&N	Effi.
ERP-200-12	12V, 0~16.8A	±1%	150mV	87%
ERP-200-24	24V, 0~8.33A	±1%	150mV	89%

ERPF-400 Series



Model No.	Output	Tol.	R&N	Effi.
ERPF-400-12	12V, 0~30A	±1%	150mV	89%
ERPF-400-24	24V, 0~16.7A	±1%	150mV	90%
ERPF-400-48	48V, 0~8.3A	±1%	240mV	91%



Features

- 150~1500Vdc 10:1 ultra-wide input range
- Potted with silicone, dust and moisture proof
- 4KVac I/O high isolation (Reinforced isolation)
- Protections: Short circuit / Overload / Over voltage / Over temperature / DC input under voltage / DC input reverse polarity
- Fanless and full encapsulated
- -30~+80°C wide operating temp. (>+55°C de-rating)
- Operating altitude up to 5000 meters
- DC OK relay contact
- Can be installed on DIN rail TS-35/7.5 or 15
- DC output voltage adjustable (+20%)
- Suitable for photovoltaic power generation, 380Vdc DC power distribution system or high voltage convert to low voltage
- 3 years warranty

External Fuse is required

Fuse Brand	Manufacturer Part NO.		MEAN WELL's Order NO.
	Fuse	Fuse Holder	Fuse + Fuse Holder
Walter Fuse	WJ30-4	WJ30-H	DDRH-WJ30-4-H
Littelfuse	SPXV-4A	LFPXV/LPXV	Not provide
Bussmann	PV-4A10F85L	CHPV15L85	Not provide

General Specification (Please refer to www.meanwell.com for detail spec.)



Model No.	DDRH-60
DC input range	150~1500Vdc
DC Output Adj.	5Vo: 5~6V, 12Vo: 12~15V, 24V: 24~29V, 48Vo: 48~54V
Line regulation (1 sec.)	±0.5%
Load regulation (max.)	±0.5% (±1.5% for 5V)
Overload protection	105 ~ 135% rated output power; Hiccup up mode when output voltage < 55%, recovers automatically after condition is removed; Constant current limiting, recovers automatically after fault condition is removed within 55% ~ 100% rated output voltage
Over voltage protection	Hiccup up mode, recovers automatically after fault condition is removed
Withstand voltage	I/P-O/P: 4KVAC, O/P-DC OK: 0.5KVAC
Working temperature (min.)	-30~+80°C (refer to output derating curve)
Safety standards	IEC62109-1(LVD), EAC TP TC 004 approved; Design refer to UL1741 (By request)
EMC standards	BS EN/EN55032 class A, EN61000-4-2,3,4,5,6,8,11
Dimension (LxWxH)(mm)	57x 93.5x 105

60W DDRH-60

Model No.	V _{in} (VDC)	V _{out} (VDC)	I _{out} (A)	R&N (mVp-p)	Effi. (%)
DDRH-60-5	150~1500	5	10	100	81
DDRH-60-12	150~1500	12	5	120	85
DDRH-60-24	150~1500	24	2.5	150	87
DDRH-60-48	150~1500	48	1.25	200	88

Photovoltaic Power System

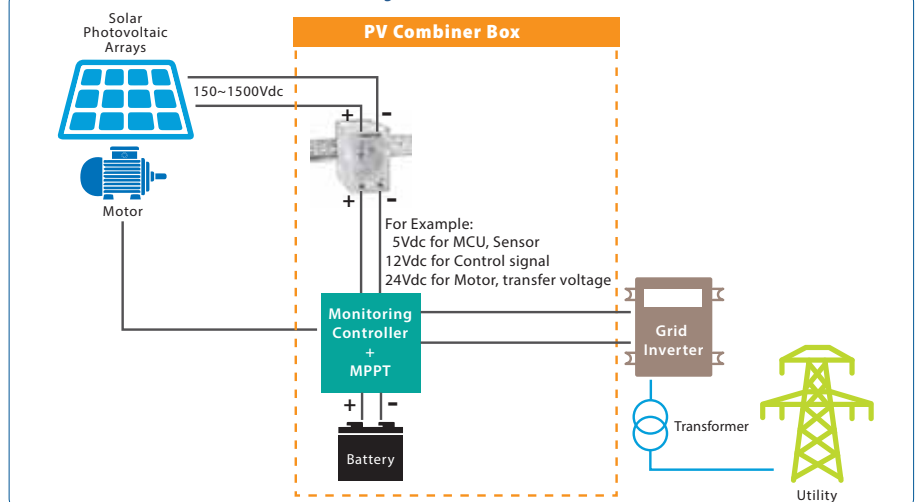



Features

- Compact size with 1SU~3SU width
- 4:1 ultra-wide input range
- Protections: Short circuit / Overload / Over voltage / Input reverse polarity / Input under voltage
- Fanless design
- Can be installed on DIN rail TS-35/7.5 or 15
- 4000VDC I/O isolation (Reinforced isolation)
- -40~+85°C ultra-wide operating temperature
- DC output adjustable ($\pm 10\%$)
- 3 years warranty

General Specification (Please refer to www.meanwell.com for detail spec.)



Model No.	DDR-15	DDR-30	DDR-60
DC input range	G: 9~36V, L: 18~75V		
Line regulation (1 sec.)	$\pm 0.5\%$		
Load regulation (max.)	$\pm 0.5\% \sim 1.5\%$ by model		
Overload protection	110%~150% hiccup mode, recovers automatically after fault condition is removed		
Over voltage protection	115%~135% Shut down O/P voltage, re-power on to recover		
Withstand voltage	I/P-O/P: 4kVDC		
Isolation resistance	100M Ω @500VDC		
Working temperature(min.)	-40~+85°C (refer to output derating curve)		
Safety standards	CB IEC62368-1, UL62368-1, AS/NZS62368.1, EAC TP TC004 approved		
EMC standards	BS EN/EN55032 class B, EN61000-3-3, EN61000-4-2,3,4,5,6,8, EN55024, EN61000-6-2(EN50082-2)		
Dimension (LxWxH)(mm)	17.5x 90x 54.5	35x 90x 54.5	52.5x 90x 54.5

15W DDR-15

Model No.	Vin (VDC)	Vout (VDC)	Iout (A)	R&N (mVp-p)	Effi. (%)
DDR-15G-3.3	9~36	3.3	3.5	50	84
DDR-15G-5	9~36	5	3	50	84
DDR-15G-12	9~36	12	1.25	60	85
DDR-15G-15	9~36	15	1	75	85
DDR-15G-24	9~36	24	0.63	100	86
DDR-15L-3.3	18~75	3.3	4.5	50	84
DDR-15L-5	18~75	5	3	50	85
DDR-15L-12	18~75	12	1.25	60	86
DDR-15L-15	18~75	15	1	75	86
DDR-15L-24	18~75	24	0.63	100	87

30W DDR-30

Model No.	Vin (VDC)	Vout (VDC)	Iout (A)	R&N (mVp-p)	Effi. (%)
DDR-30G-5	9~36	5	6	60	85
DDR-30G-12	9~36	12	2.5	75	86
DDR-30G-15	9~36	15	2	75	87
DDR-30G-24	9~36	24	1.25	100	89

Model No.	Vin (VDC)	Vout (VDC)	Iout (A)	R&N (mVp-p)	Effi. (%)
DDR-30L-5	18~75	5	6	60	86
DDR-30L-12	18~75	12	2.5	75	89
DDR-30L-15	18~75	15	2	75	90
DDR-30L-24	18~75	24	1.25	100	91

60W DDR-60

Model No.	Vin (VDC)	Vout (VDC)	Iout (A)	R&N (mVp-p)	Effi. (%)
DDR-60G-5	9~36	5	10.8	60	87.5
DDR-60G-12	9~36	12	5	75	91
DDR-60G-15	9~36	15	4	75	91
DDR-60G-24	9~36	24	2.5	100	91
DDR-60L-5	18~75	5	12	60	87.5
DDR-60L-12	18~75	12	5	75	91
DDR-60L-15	18~75	15	4	75	92
DDR-60L-24	18~75	24	2.5	100	92

DC/DC Converter 120~480W Railway & ITE DIN Rail Type



Features

- **Railway & ITE dual certification**
- 2:1 wide input range
- **150% peak load capability**
- Protections:
Short circuit / Overload / Over voltage / Over temp. /
DC input reverse polarity / DC input under voltage Lockout
- **Fanless design**
- 4000VDC I/O isolation (**Reinforced isolation**)
- **-40~+70°C wide operating temperature**
- DC output adjustable(+15%)
- DC OK relay contact and Remote ON/OFF (DDR-240/480 only)
- **Current sharing up to 1920W**
(3+1: 960W for DDR-240, 1920W for DDR-480)
- 3 years warranty

General Specification (Please refer to www.meanwell.com for detail spec.)



Model No.	DDR-120	DDR-240	DDR-480
DC input range	A: 9~18V, B: 16.8~33.6V, C: 33.6~67.2V, D: 67.2~154V	B: 16.8~33.6V, C: 33.6~67.2V, D: 67.2~154V	
DC output adj.range	12Vo: 9~14V(120W only), 24Vo: 24~28V, 48Vo: 48~56V		
Line regulation (1 sec.)	±0.5%		
Load regulation (max.)	±1%		
Overload protection	105%~135% rated output power for more than 3 seconds and then shut down O/P voltage with auto-recovery		150% rated output power for more than 5 seconds and then constant current protection 105~135% rated output power with auto-recovery
Over voltage protection	120%~135% Shut down O/P voltage, re-power on to recover		
Withstand voltage	I/P-O/P: 4kVDC, I/P-FG: 2.5kVDC, O/P-FG: 2.5kVDC	I/P-O/P: 4kVDC, I/P-FG: 2.5kVDC, O/P-FG: 0.71kVDC	
Isolation resistance	100MΩ@500VDC		
Working temperature(min.)	-40~+70°C (refer to output derating curve)		-40~+80
Safety standards	Industrial	CB IEC62368-1, UL62368-1, AS/NZS62368.1, EAC TP TC004 approved	
	Railway	BS EN/EN50155: 2007—Comply with S1 level(3ms) and S2 level (10ms), refer to spec for load derating curve 2017—Comply with S1 level; S2 level (DDR-480) IEC60571, IEC61373, EN45545-2 (except for 9~18Vin)	
EMC standards	BS EN/EN55032 class B, EN61000-3,-2,-3, EN61000-4-2,3,4,5,6,8, EAC TP TC 020; EN50121-3-2 (except for 9~18Vin)		BS EN/EN55035, EN61000-4-2,3,4,5,6,8
Dimension (LxWxH)(mm)	32x 125.2x 102	40x 125.2x 113.5	85.5x 125.2x 128.5

120W DDR-120

Model No.	Vin (VDC)	Vout (VDC)	Iout (A)	R&N (mVp-p)	Effi. (%)
DDR-120A-12	9~18	12	8.3	50	88.5
DDR-120A-24	9~18	24	4.2	50	88.5
DDR-120A-48	9~18	48	2.1	50	88.5
DDR-120B-12	16.8~33.6	12	10	50	89.0
DDR-120B-24	16.8~33.6	24	5	50	89.5
DDR-120B-48	16.8~33.6	48	2.5	50	91.0
DDR-120C-12	33.6~67.2	12	10	50	89.5
DDR-120C-24	33.6~67.2	24	5	50	91.0
DDR-120C-48	33.6~67.2	48	2.5	50	92.0
DDR-120D-12	67.2~154	12	10	50	89.5
DDR-120D-24	67.2~154	24	5	50	91.0
DDR-120D-48	67.2~154	48	2.5	50	91.5

240W DDR-240

Model No.	Vin (VDC)	Vout (VDC)	Iout (A)	R&N (mVp-p)	Effi. (%)
DDR-240B-24	16.8~33.6	24	10	80	90
DDR-240B-48	16.8~33.6	48	5	100	90

240W DDR-240

Model No.	Vin (VDC)	Vout (VDC)	Iout (A)	R&N (mVp-p)	Effi. (%)
DDR-240C-24	33.6~67.2	24	10	80	91
DDR-240C-48	33.6~67.2	48	5	100	92
DDR-240D-24	67.2~154	24	10	80	92
DDR-240D-48	67.2~154	48	5	100	92.5

480W NEW DDR-480

Model No.	Vin (VDC)	Vout (VDC)	Iout (A)	R&N (mVp-p)	Effi. (%)
DDR-480B-12	16.8~33.6	12	33.4	100	90
DDR-480B-24	16.8~33.6	24	20	120	91
DDR-480B-48	16.8~33.2	48	10	150	91
DDR-480C-12	33.6~67.2	12	33.4	100	91
DDR-480C-24	33.6~67.2	24	20	120	92
DDR-480C-48	33.6~67.2	48	10	150	92
DDR-480D-12	67.2~154	12	33.4	100	91
DDR-480D-24	67.2~154	24	20	120	92
DDR-480D-48	67.2~154	48	10	150	93

DC/DC Converter 30~150W Railway & ITE Enclosed Type



Features

- **Railway & ITE dual certification**
- **4:1 wide input range (RSD-30/60)**
2:1 wide input range (RSD-100/150)
- **4000VDC I/O isolation**
- **Protections: Short circuit / Overload / Over voltage / DC Input reverse polarity**
- **Fanless design**
- **Built-in constant current limiting circuit**
- **Ultra compact and 1U low profile**
- **All using 105°C long life electrolytic capacitors**
- **Half encapsulated (5G vibration)**
- **3 years warranty**

General Specification (Please refer to www.meanwell.com for detail spec.)



Model No.	RSD-30	RSD-60	RSD-100	RSD-150
DC input range	G: 9~36V, L: 18~72V, H: 40~160V		B: 16.8~31.2V, C: 33.6~62.4V, D: 67.2~143V	
Overload protection	105%~135% constant current limiting, recovers automatically after fault condition is removed			
Over voltage protection	115%~135% Shut down O/P voltage, re-power on to recover			115%~140%
Withstand voltage	I/P-O/P: 4kVDC, I/P-FG: 2.5kVDC, O/P-FG: 2.5kVDC, 1 minute			
Isolation resistance	100MΩ@500VDC			
Working temperature (min.)	-40~+70°C (refer to output derating curve)			
Safety standards	Industrial	CB IEC62368-1, UL62368-1, AS/NZS62368.1, EAC TP TC004		
	Railway	BS EN/EN50155: 2007—Comply with S1 level(3ms) and S2 level (10ms), refer to spec for load derating curve		
		2017—Comply with S1 level IEC60571; EN45545-2		
EMC standards	BS EN/EN55032 class B (class A for conduction), EN61000-3,-2,3, EN61000-4-2,3,4,5,6, EN50121-3-2		BE EN/EN55032 class B (class A for conduction), EN61000-4-2,3,4,5,6,8, EAC TP TC 020, EN50121-3-2	
Dimension (LxWxH)(mm)	113x 60x 25	128x 60x 25	161x 68x 36	189x77x36

30W

RSD-30

Model No.	Vin (VDC) (continuous)	Vout (VDC)	Iout (A)	R&N (mVp-p)	Effi. (%)
RSD-30G-3.3	9~36	3.3	6	70	84
RSD-30G-5	9~36	5	6	70	84
RSD-30G-12	9~36	12	2.5	60	86.5
RSD-30G-24	9~36	24	1.25	50	89
RSD-30L-3.3	18~72	3.3	6	70	84
RSD-30L-5	18~72	5	6	70	86
RSD-30L-12	18~72	12	2.5	60	90
RSD-30L-24	18~72	24	1.25	50	91
RSD-30H-3.3	40~160	3.3	6	70	87
RSD-30H-5	40~160	5	6	70	87
RSD-30H-12	40~160	12	2.5	60	89
RSD-30H-24	40~160	24	1.25	50	89

100W

RSD-100

Model No.	Vin (VDC) (1 sec / continuous)	Vout (VDC)	Iout (A)	R&N (mVp-p)	Effi. (%)
RSD-100B-5	14.4~33.6 / 16.8~31.2	5	20	100	88
RSD-100B-12	14.4~33.6 / 16.8~31.2	12	8.4	120	89
RSD-100B-24	14.4~33.6 / 16.8~31.2	24	4.2	150	89
RSD-100C-5	28.8~67.2 / 33.6~62.4	5	20	100	89
RSD-100C-12	28.8~67.2 / 33.6~62.4	12	8.4	120	91
RSD-100C-24	28.8~67.2 / 33.6~62.4	24	4.2	150	91
RSD-100D-5	57.6~154 / 67.2~143	5	20	100	89.5
RSD-100D-12	57.6~154 / 67.2~143	12	8.4	120	91
RSD-100D-24	57.6~154 / 67.2~143	24	4.2	150	90

60W

RSD-60

Model No.	Vin (VDC) (continuous)	Vout (VDC)	Iout (A)	R&N (mVp-p)	Effi. (%)
RSD-60G-3.3	9~36	3.3	12	60	86.5
RSD-60G-5	9~36	5	12	100	88
RSD-60G-12	9~36	12	5	50	92
RSD-60G-24	9~36	24	2.5	50	90
RSD-60L-3.3	18~72	3.3	12	60	88.5
RSD-60L-5	18~72	5	12	60	89
RSD-60L-12	18~72	12	5	50	93
RSD-60L-24	18~72	24	2.5	50	91.5
RSD-60H-3.3	40~160	3.3	12	80	87.5
RSD-60H-5	40~160	5	12	60	89
RSD-60H-12	40~160	12	5	50	92.5
RSD-60H-24	40~160	24	2.5	50	91.5

150W

RSD-150

Model No.	Vin (VDC) (1 sec / continuous)	Vout (VDC)	Iout (A)	R&N (mVp-p)	Effi. (%)
RSD-150B-5	14.4~33.6 / 16.8~31.2	5	30	100	89
RSD-150B-12	14.4~33.6 / 16.8~31.2	12	12.5	120	90
RSD-150B-24	14.4~33.6 / 16.8~31.2	24	6.3	150	90
RSD-150C-5	28.8~67.2 / 33.6~62.4	5	30	100	90
RSD-150C-12	28.8~67.2 / 33.6~62.4	12	12.5	120	92
RSD-150C-24	28.8~67.2 / 33.6~62.4	24	6.3	150	91
RSD-150D-5	57.6~154 / 67.2~143	5	30	100	90
RSD-150D-12	57.6~154 / 67.2~143	12	12.5	120	92
RSD-150D-24	57.6~154 / 67.2~143	24	6.3	150	91

DC/DC Converter 200~500W Railway & ITE Enclosed Type



Features

- **Railway & ITE dual certification**
- **2:1 wide input range**
- **4000VDC I/O isolation**
- **Protections:**
Short circuit / Overload / Over voltage / **DC input reverse polarity** / Over temperature
- **Fanless design**
- **Built-in constant current limiting circuit**
- **1U low profile**
- **All using 105°C long life electrolytic capacitors**
- **Half encapsulated (5G vibration)**
- **3 years warranty**

General Specification (Please refer to www.meanwell.com for detail spec.)



Model No.	RSD-200	RSD-300	RSD-500
DC input range	B: 16.8~31.2V, C: 33.6~62.4V, D: 67.2~143V, E: 25.2~46.8V, F: 50.4~93.6V		
Line regulation (1 sec.)	±0.5%		
Load regulation (max.)	±1%		
Overload protection	105%~135% constant current limiting, recovers automatically after fault condition is removed		
Over voltage protection	115%~135% Shut down O/P voltage, re-power on to recover	115%~140%	120%~145%
Withstand voltage	I/P-O/P: 4kVDC, I/P-FG: 2.5kVDC, O/P-FG: 2.5kVDC, 1 minute		
Isolation resistance	100MΩ@500VDC		
Working temperature(min.)	-40~+70°C (refer to output derating curve)		-40~+80°C
Safety standards	Industrial	CB IEC62368-1, UL62368-1, AS/NZS62368.1, EAC TP TC004	
	Railway	BS EN/EN50155: 2007—Comply with S1 level(3ms) and S2 level (10ms), please refer to spec for load derating curve	
		2017—Comply with S1 level;S2 level(RSD-500)	
EMC standards	BS EN/EN55032 class B, EN50121-3-2, EN61000-4-2,3,4,5,6,8, EN50121-3-2		
Dimension (LxWxH)(mm)	191x 86x 40	216x 96.5x 40	237x 100x 41

200W RSD-200

Model No.	Vin (VDC) (1 sec / continuous)	Vout (VDC)	Iout (A)	R&N (mVp-p)	Effi. (%)
RSD-200B-12	14.4~33.6 / 16.8~31.2	12	16.7	120	89
RSD-200B-24	14.4~33.6 / 16.8~31.2	24	8.4	150	89
RSD-200B-48	14.4~33.6 / 16.8~31.2	48	4.2	180	89
RSD-200C-12	28.8~67.2 / 33.6~62.4	12	16.7	120	91
RSD-200C-24	28.8~67.2 / 33.6~62.4	24	8.4	150	91
RSD-200C-48	28.8~67.2 / 33.6~62.4	48	4.2	180	91
RSD-200D-12	57.6~154 / 67.2~143	12	16.7	120	91
RSD-200D-24	57.6~154 / 67.2~143	24	8.4	150	91
RSD-200D-48	57.6~154 / 67.2~143	48	4.2	180	91

300W RSD-300

Model No.	Vin (VDC) (1 sec / continuous)	Vout (VDC)	Iout (A)	R&N (mVp-p)	Effi. (%)
RSD-300D-24	57.6~154 / 67.2~143	24	12.5	150	91.5
RSD-300D-48	57.6~154 / 67.2~143	48	6.3	180	91.5
RSD-300E-5	21.6~50.4 / 25.2~46.8	5	42	100	88
RSD-300E-12	21.6~50.4 / 25.2~46.8	12	25	120	90
RSD-300E-24	21.6~50.4 / 25.2~46.8	24	12.5	150	91
RSD-300E-48	21.6~50.4 / 25.2~46.8	48	6.3	180	91
RSD-300F-5	43.2~100.8 / 50.4~93.6	5	42	100	89
RSD-300F-12	43.2~100.8 / 50.4~93.6	12	25	120	91
RSD-300F-24	43.2~100.8 / 50.4~93.6	24	12.5	150	91
RSD-300F-48	43.2~100.8 / 50.4~93.6	48	6.3	180	91.5

300W RSD-300

Model No.	Vin (VDC) (1 sec / continuous)	Vout (VDC)	Iout (A)	R&N (mVp-p)	Effi. (%)
RSD-300B-5	14.4~33.6 / 16.8~31.2	5	42	100	89
RSD-300B-12	14.4~33.6 / 16.8~31.2	12	22.5	120	89.5
RSD-300B-24	14.4~33.6 / 16.8~31.2	24	11.3	150	90
RSD-300B-48	14.4~33.6 / 16.8~31.2	48	5.7	180	91.5
RSD-300C-5	28.8~67.2 / 33.6~62.4	5	42	100	90.5
RSD-300C-12	28.8~67.2 / 33.6~62.4	12	25	120	91
RSD-300C-24	28.8~67.2 / 33.6~62.4	24	12.5	150	91.5
RSD-300C-48	28.8~67.2 / 33.6~62.4	48	6.3	180	92
RSD-300D-5	57.6~154 / 67.2~143	5	42	100	90
RSD-300D-12	57.6~154 / 67.2~143	12	25	120	91.5

500W NEW RSD-500

Model No.	Vin (VDC) (1 sec / continuous)	Vout (VDC)	Iout (A)	R&N (mVp-p)	Effi. (%)
RSD-500B-12	14.4~16.8 / 16.8~33.6	12	35	100	92
RSD-500B-24	14.4~16.8 / 16.8~33.6	24	17.5	120	92
RSD-500B-48	14.4~16.8 / 16.8~33.6	48	8.8	150	92
RSD-500C-12	28.8~33.6 / 33.6~67.2	12	35	100	93
RSD-500C-24	28.8~33.6 / 33.6~67.2	24	19.2	120	93
RSD-500C-48	28.8~33.6 / 33.6~67.2	48	9.6	150	93
RSD-500D-12	57.6~67.2 / 67.2~154	12	35	100	93
RSD-500D-24	57.6~67.2 / 67.2~154	24	20.8	120	93
RSD-500D-48	57.6~67.2 / 67.2~154	48	10.4	150	93

DC/DC Converter

15~100W ITE Enclosed Type



Features

- 2:1 wide input range
- I/O isolation:
1500VAC (2000VAC for 15W)
- Protections:
Short circuit / Overload /
Over voltage
- Cooling by free air convection
- 2 years warranty

General Specification (Please refer to www.meanwell.com for detail spec.)

Model No.	SD-15	SD-25	SD-50	SD-100
DC input range	A: 9.2~18V(9.5~15.6 for SD-100A only), B: 19~36V(18~36V for SD-15), C: 36~72V; D: 72~144V (SD-100 only)			
DC adjustment range	5V: 4.5~5.5V, 12V: 11~16V, 24V: 23~30V (5V: 4.75~5.5V, 12V: 10.8~13.2V, 24V: 21.6~26.4V for SD-15)			
Line and load regulation (max.)	±0.5% (±0.2%~±0.5% for SD-100A only)			
Overload protection	105%~160% hiccup mode, auto-recovery	105%~150% hiccup mode, auto-recovery		105%~135% hiccup mode, auto-recovery
Over voltage protection	115%~135% rated output voltage	115%~165% rated output voltage		
Withstand voltage	I/P-O/P: 2kVAC, I/P-FG: 1.5kVAC, 1 minute		I/P-O/P: 1.5kVAC, I/P-FG: 2kVAC, 1 minute	
Working temperature	-10~+60°C (refer to output derating curve)			
Safety standards	AS/NZ62368.1, EAC TP TC 004; CB TUV BS EN/EN62368-1 approved(SD-100 D type only); design refer to IEC62368-1(SD-100 A type only)			
EMC standards	AS/NZS62368.1(SD-50 only), BS EN/EN55032 class B, EN61000-4-2,3,4,6,8, EAC TP TC 020			
Dimension (LxWxH) (mm)	78x 51x 28	99x 97x 36	159x 97x 38	199x 98x 38

15W



Model No.	Vin (VDC)	Vout (VDC)	Iout (A)	R&N (mVp-p)	Effi. (%)
SD-15A-5	9.2~18	5	3	100	68
SD-15A-12	9.2~18	12	1.25	120	72
SD-15A-24	9.2~18	24	0.625	150	70
SD-15B-5	18~36	5	3	100	76
SD-15B-12	18~36	12	1.25	120	76
SD-15B-24	18~36	24	0.625	150	77
SD-15C-5	36~72	5	3	100	75
SD-15C-12	36~72	12	1.25	120	79
SD-15C-24	36~72	24	0.625	150	78

50W



Model No.	Vin (VDC)	Vout (VDC)	Iout (A)	R&N (mVp-p)	Effi. (%)
SD-50A-5	9.2~18	5	10	100	70
SD-50A-12	9.2~18	12	4.2	120	72
SD-50A-24	9.2~18	24	2.1	150	74
SD-50B-5	19~36	5	10	100	73
SD-50B-12	19~36	12	4.2	120	75
SD-50B-24	19~36	24	2.1	150	80
SD-50C-5	36~72	5	10	100	76
SD-50C-12	36~72	12	4.2	120	78
SD-50C-24	36~72	24	2.1	150	83

25W



Model No.	Vin (VDC)	Vout (VDC)	Iout (A)	R&N (mVp-p)	Effi. (%)
SD-25A-5	9.2~18	5	5	100	71
SD-25A-12	9.2~18	12	2.1	120	72
SD-25A-24	9.2~18	24	1.1	150	75
SD-25B-5	19~36	5	5	100	72
SD-25B-12	19~36	12	2.1	120	75
SD-25B-24	19~36	24	1.1	150	78
SD-25C-5	36~72	5	5	100	74
SD-25C-12	36~72	12	2.1	120	78
SD-25C-24	36~72	24	1.1	150	81

100W



Model No.	Vin (VDC)	Vout (VDC)	Iout (A)	R&N (mVp-p)	Effi. (%)
SD-100A-5	9.5~18	5	18	100	78
SD-100A-12	9.5~18	12	8.5	120	82
SD-100A-24	9.5~18	24	4.2	150	84
SD-100B-5	19~36	5	20	100	74
SD-100B-12	19~36	12	8.5	120	75
SD-100B-24	19~36	24	4.2	150	78
SD-100C-5	36~72	5	20	100	75
SD-100C-12	36~72	12	8.5	120	77
SD-100C-24	36~72	24	4.2	150	81
SD-100D-5	72~144	5	20	100	76
SD-100D-12	72~144	12	8.5	120	80
SD-100D-24	72~144	24	4.2	150	83

DC/DC Converter

150~1000W ITE Enclosed Type



Features

- 2:1 wide input range (4:1 input for SD-500/1000)
- I/O Isolation: 1500VAC, 2000VAC (SD-500/1000)
- Protections: Short circuit / Overload / Over voltage / Over temperature (except for SD-150) / Input polarity (SD-500 only)
- Fanless design, cooling by free air convection (SD-150/200), forced air cooling by built-in DC fan (SD-350/500/1000)
- DC input active surge current limiting (SD-500)
- Output OK signal (SD-500/1000)
- 1U low profile 41mm (SD-1000)
- 12V / 0.25A auxiliary output (SD-500/1000)
- Built-in remote ON/OFF control and remote sense (SD-500/1000)
- 2 years warranty, 3 years warranty (SD-500/1000)

General Specification (Please refer to www.meanwell.com for detail spec.)

Model No.	SD-150	SD-200	SD-350	SD-500	SD-1000
DC input range	B: 19~36V, C: 36~72V, D: 72~144V			L: 19~72V, H: 72~144V	
Vout adjustment range	12V: 11~16V, 24V: 23~30V	5V: 4.5~5.5V, 12V: 11~16V, 24V: 23~30V, 48V: 43~53V		12V: 11~15V, 24V: 23~30V, 48V: 46~60V	
Line and load regulation (max.)	±0.5%		±0.2%~±0.5%	±0.5%	
Overload protection	105%~135% hiccup mode, auto-recovery	105%~135% shut off, re-power on to recover		105%~125% constant current limiting, shut off after 5 sec., re-power on to recover	
Over voltage protection	130%~165%	110%~167% rated output voltage		130%~160% rated output voltage	
Withstand voltage	I/P-O/P: 1.5kVAC, I/P-FG: 2kVAC, O/P-FG: 0.5kVAC			I/P-O/P: 2kVAC, I/P-FG: 2kVAC, O/P-FG: 0.5kVAC	
Working temperature	-10~+60°C	-20~+60°C			
Safety standards	CB IEC62368-1(D type only), TUV BS EN/EN62368-1 (D Type only) AS/NZS62368.1, EAC TP TC004 approved			CB IEC62368-1, TUV BS EN/EN62368-1, AS/NZ62368.1 EAC TP TC004 approved	
EMC standards	BS EN/EN55032 class B, EN61000-4-2,3,4,6,8, EAC TP TC 020				
Dimension (LxWxH) (mm)	199x 110x 50	215x 115x 50			295x 127x 41

150W



Model No.	Vin (VDC)	Vout (VDC)	Iout (A)	R&N (mVp-p)	Effi. (%)
SD-150B-12	19~36	12	12.5	120	75
SD-150B-24	19~36	24	6.3	150	77
SD-150C-12	36~72	12	12.5	120	77
SD-150C-24	36~72	24	6.3	150	80
SD-150D-12	72~144	12	12.5	120	79
SD-150D-24	72~144	24	6.3	150	82

350W

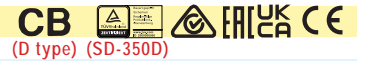

Model No.	Vin (VDC)	Vout (VDC)	Iout (A)	R&N (mVp-p)	Effi. (%)
SD-350B-5	19~36	5	57	100	74
SD-350B-12	19~36	12	27.5	120	80
SD-350B-24	19~36	24	14.6	150	80
SD-350B-48	19~36	48	7.3	200	84
SD-350C-5	36~72	5	60	100	76
SD-350C-12	36~72	12	27.5	120	81
SD-350C-24	36~72	24	14.6	150	81
SD-350C-48	36~72	48	7.3	200	82
SD-350D-5	72~144	5	60	100	78
SD-350D-12	72~144	12	29.2	120	83
SD-350D-24	72~144	24	14.6	150	87
SD-350D-48	72~144	48	7.3	200	89

200W



Model No.	Vin (VDC)	Vout (VDC)	Iout (A)	R&N (mVp-p)	Effi. (%)
SD-200B-5	19~36	5	34	100	79
SD-200B-12	19~36	12	16.7	120	82
SD-200B-24	19~36	24	8.4	150	85
SD-200B-48	19~36	48	4.2	200	86
SD-200C-5	36~72	5	40	100	81
SD-200C-12	36~72	12	16.7	120	84
SD-200C-24	36~72	24	8.4	150	86
SD-200C-48	36~72	48	4.2	200	86
SD-200D-5	72~144	5	40	100	82
SD-200D-12	72~144	12	16.7	120	82
SD-200D-24	72~144	24	8.4	150	84
SD-200D-48	72~144	48	4.2	200	90

500W



Model No.	Vin (VDC)	Vout (VDC)	Iout (A)	R&N (mVp-p)	Effi. (%)
SD-500L-12	19~72	12	40	150	86
SD-500L-24	19~72	24	21	150	88
SD-500L-48	19~72	48	10.5	150	89
SD-500H-12	72~144	12	40	150	87
SD-500H-24	72~144	24	21	150	89
SD-500H-48	72~144	48	10.5	150	90

1000W



Model No.	Vin (VDC)	Vout (VDC)	Iout (A)	R&N (mVp-p)	Effi. (%)
SD-1000L-12	19~72	12	60	150	84
SD-1000L-24	19~72	24	40	150	88
SD-1000L-48	19~72	48	21	150	90
SD-1000H-12	72~144	12	60	150	85
SD-1000H-24	72~144	24	40	150	89
SD-1000H-48	72~144	48	21	150	92

DC/DC Converter 8~10W Railway DIP Module Type



RSDW08/RDDW08
(1.25"x 0.8"x 0.4")



RSDW10/RDDW10
(1.25"x 0.8"x 0.4")



RSDW08/10 & RDDW08/10 Series

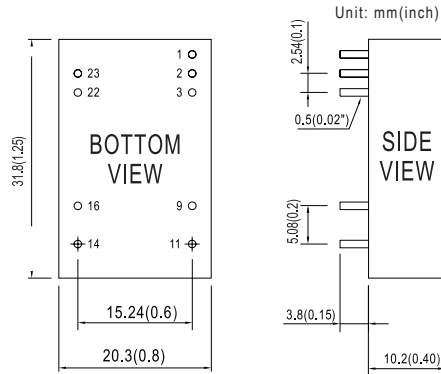

Pin No.	Pin-Out	
	Single	Dual
1	R.C	R.C
2,3	-Vin	-Vin
9	N.P.	Common
11	N.C.	-Vout
14	+Vout	+Vout
16	-Vout	Common
22,23	+Vin	+Vin

DIP24 Package, Regulated 8W, 4:1 V_{in} , Single V_{out}

RSDW08 (EN55015/EN55032)

Model No.	V_{in}	V_{out}	I_{out}	Isolation voltage	Operating temperature
RSDW08F-03		3.3V	2000mA		
RSDW08F-05	12V, 24V	5V	1600mA	1.5KVDC	-40~+85°C
RSDW08F-12	(9~36V)	12V	666mA		
RSDW08F-15		15V	530mA		
RSDW08G-03		3.3V	2000mA		
RSDW08G-05	24V, 48V	5V	1600mA	1.5KVDC	-40~+85°C
RSDW08G-12	(18~75V)	12V	666mA		
RSDW08G-15		15V	530mA		

DIP24 Package, Regulated 8W, 4:1 V_{in} , Dual V_{out}

RDDW08 (EN55015/EN55032)

Model No.	V_{in}	V_{out}	I_{out}	Isolation voltage	Operating temperature
RDDW08F-05	12V, 24V	±5V	±800mA	1.5KVDC	-40~+85°C
RDDW08F-12	(9~36V)	±12V	±333mA		
RDDW08F-15		±15V	±265mA		
RDDW08G-05	24V, 48V	±5V	±800mA	1.5KVDC	-40~+85°C
RDDW08G-12	(18~75V)	±12V	±333mA		
RDDW08G-15		±15V	±265mA		

DIP24 Package, Regulated 10W, 4:1 V_{in} , Single V_{out}

RSDW10 (EN55015/EN55032)

Model No.	V_{in}	V_{out}	I_{out}	Isolation voltage	Operating temperature
RSDW10H-03		3.3V	2500mA		
RSDW10H-05	72V, 96V, 110V	5V	2000mA	3KVDC	-40~+85°C
RSDW10H-12	(43~160V)	12V	835mA		
RSDW10H-15		15V	666mA		

DIP24 Package, Regulated 10W, 4:1 V_{in} , Dual V_{out}

RDDW10 (EN55015/EN55032)

Model No.	V_{in}	V_{out}	I_{out}	Isolation voltage	Operating temperature
RDDW10H-05	72V, 96V, 110V	±5V	±1000mA	3KVDC	-40~+85°C
RDDW10H-12	(43~160V)	±12V	±416mA		
RDDW10H-15		±15V	±333mA		

DC/DC Converter

20W Railway 2"x1" Module Type



RSDW20/RDDW20
(2"x 1"x 0.4")



NEW
RSDW20UW/RDDW20UW
(2"x 1"x 0.4")



RSDW20F&G / RDDW20F&G Series

RSDW20H / RDDW20H / RSDW20UW / RDDW20UW Series

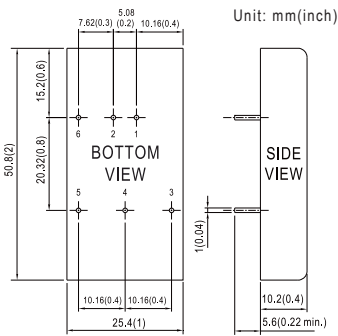

Pin No.	Pin-Out	
	Single	Dual
1	+Vin	
2	-Vin	
3	+Vout	
4	Trim	Common
5	-Vout	
6	Remote ON/OFF	

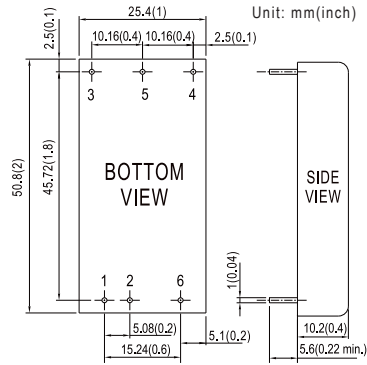

Pin No.	Pin-Out	
	Single	Dual
1	+Vin	
2	-Vin	
3	+Vout	
4	Trim	-Vout
5	-Vout	Common
6	Remote ON/OFF	

2"x1" Package, Regulated 20W, 4:1 V_{in}, Single V_{out}

RSDW20



(EN50155/EN55032)

Model No.	V _{in}	V _{out}	I _{out}	Isolation voltage	Operating temperature
RSDW20F-03		3.3V	5500mA		
RSDW20F-05	12V, 24V	5V	4000mA	1.5KVDC	-40~+85°C
RSDW20F-12	(9~36V)	12V	1670mA		
RSDW20F-15		15V	1330mA		
RSDW20G-03		3.3V	5500mA		
RSDW20G-05	24V, 48V	5V	4000mA	1.5KVDC	-40~+85°C
RSDW20G-12	(18~75V)	12V	1670mA		
RSDW20G-15		15V	1330mA		
RSDW20H-05	22V, 96V, 110V	5V	4000mA	3KVDC	-40~+85°C
RSDW20H-12	(43~160V)	12V	1670mA		
RSDW20H-15		15V	1330mA		

2"x1" Package, Regulated 20W, 4:1 V_{in}, Dual V_{out}

RDDW20



(EN50155/EN55032)

Model No.	V _{in}	V _{out}	I _{out}	Isolation voltage	Operating temperature
RDDW20F-05	12V, 24V	±5V	±2000mA	1.5KVDC	-40~+85°C
RDDW20F-12	(9~36V)	±12V	±835mA		
RDDW20F-15		±15V	±666mA		
RDDW20G-05	24V, 48V	±5V	±2000mA	1.5KVDC	-40~+85°C
RDDW20G-12	(18~75V)	±12V	±835mA		
RDDW20G-15		±15V	±666mA		
RDDW20H-12	72V, 96V, 110V	±12V	±1833mA	3KVDC	-40~+85°C
RDDW20H-15	(43~160V)	±15V	±667mA		

2"x1" Package, Regulated 20W, 18:1 V_{in}, Single V_{out}

NEW

RSDW20UW



(EN50155)

Model No.	V _{in}	V _{out}	I _{out}	Isolation voltage	Operating temperature
RSDW20UW-05	12V, 24V, 48V	5V	4000mA	3KVAC	-40~+90°C
RSDW20UW-12	72V, 96V, 110V	12V	1670mA		
RSDW20UW-15	(8.5~160V)	15V	1330mA		

2"x1" Package, Regulated 20W, 18:1 V_{in}, Dual V_{out}

NEW

RDDW20UW



(EN50155)

Model No.	V _{in}	V _{out}	I _{out}	Isolation voltage	Operating temperature
RDDW20UW-12	12V, 24V, 48V	±12V	±833mA	3KVAC	-40~+90°C
RDDW20UW-15	72V, 96V, 110V	±15V	±667mA		
RDDW20UW-24	(8.5~160V)	±24V	±417mA		

DC/DC Converter

40~60W Railway 2"x1" Module Type



RSDW40/RDDW40
(2"x 1"x 0.41")



RSDW60/RDDW60
(2"x 1"x 0.41")



NEW

RSDW40/60 & RDDW40/60 Series

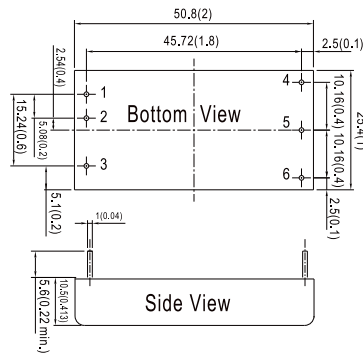

Pin No.	Pin-Out	
	Single	Dual
1	+Vin	
2	-Vin	
3	Remote ON/OFF	
4	+Vout	
5	-Vout	Common
6	Trim	-Vout

2"x1" Package, Regulated 40W, 4:1 V_{in}, Single V_{out}

RSDW40



(EN50155/EN55032)

Model No.	V _{in}	V _{out}	I _{out}	Isolation voltage	Operating temperature
RSDW40F-03	12V, 24V (9~36V)	3.3V	10A	1.6KVDC	-40~+90°C
RSDW40F-05		5V	8A		
RSDW40F-12		12V	3333mA		
RSDW40F-15		15V	2666mA		
RSDW40G-03	24V, 48V (18~75V)	3.3V	10A	1.6KVDC	-40~+90°C
RSDW40G-05		5V	8A		
RSDW40G-12		12V	3333mA		
RSDW40G-15		15V	2666mA		
RSDW40H-05	72V, 96V, 110V (40~160V)	5V	8A	3KVDC	-40~+90°C
RSDW40H-12		12V	3333mA		
RSDW40H-24		24V	1667mA		
RSDW40H-48		48V	833mA		

2"x1" Package, Regulated 40W, 4:1 V_{in}, Dual V_{out}

RDDW40



(EN50155/EN55032)

Model No.	V _{in}	V _{out}	I _{out}	Isolation voltage	Operating temperature
RDDW40F-12	12V, 24V (9~36V)	±12V	±1666mA	1.6KVDC	-40~+90°C
RDDW40F-15		±15V	±1333mA		
RDDW40G-12	24V, 48V (18~75V)	±12V	±1666mA	1.6KVDC	-40~+90°C
RDDW40G-15		±15V	±1333mA		

2"x1" Package, Regulated 60W, 4:1 V_{in}, Single V_{out}

RSDW60



(EN50155/EN55032)

Model No.	V _{in}	V _{out}	I _{out}	Isolation voltage	Operating temperature
RSDW60F-03	12V, 24V (9~36V)	3.3V	12A	1.6KVDC	-40~+85°C
RSDW60F-05		5V	12A		
RSDW60F-12		12V	5A		
RSDW60F-15		15V	4A		
RSDW60F-24	24V	2.5A			
RSDW60G-03	24V, 48V (18~75V)	3.3V	12A	1.6KVDC	-40~+85°C
RSDW60G-05		5V	12A		
RSDW60G-12		12V	5A		
RSDW60G-15		15V	4A		
RSDW60G-24	24V	2.5A			
RSDW60H-05	72V, 96V, 110V (40~160V)	5V	12A	3KVDC	-40~+85°C
RSDW60H-12		12V	5A		
RSDW60H-24		24V	2.5A		
RSDW60H-48		48V	1.25A		

2"x1" Package, Regulated 60W, 4:1 V_{in}, Dual V_{out}

RDDW60



(EN50155/EN55032)

Model No.	V _{in}	V _{out}	I _{out}	Isolation voltage	Operating temperature
RDDW60F-12	12V, 24V (9~36V)	±12V	±2.5A	1.6KVDC	-40~+85°C
RDDW60F-15		±15V	±2.0A		
RDDW60G-12	24V, 48V (18~75V)	±12V	±2.5A	1.6KVDC	-40~+85°C
RDDW60G-15		±15V	±2.0A		

DC/DC Converter 1~2W Medical Grade SIP Module Type



MDS01
(0.77"x 0.39"x 0.49")



MDD01
(0.77"x 0.39"x 0.49")

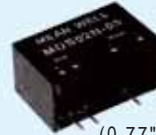

MDS02
(0.77"x 0.39"x 0.49")



MDD02
(0.77"x 0.39"x 0.49")

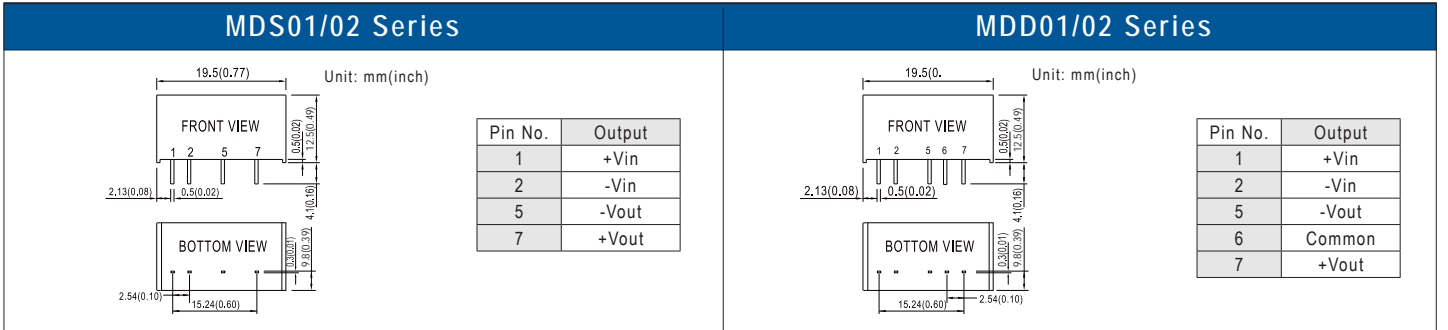

SIP7, Medical Grade Unregulated 1W, ±10% V_{in}, Single V_{out} MDS01

Model No.	V _{in}	V _{out}	I _{out}	Isolation voltage	Operating temperature
MDS01L-03		3.3V	303mA		
MDS01L-05	5V	5V	200mA		
MDS01L-12	(4.5~5.5V)	12V	84mA	6KVDC	-40~+85°C
MDS01L-15		15V	67mA		
MDS01M-05	12V	5V	200mA		
MDS01M-12	(10.8~13.2V)	12V	84mA	6KVDC	-40~+85°C
MDS01M-15		15V	67mA		
MDS01N-05	24V	5V	200mA		
MDS01N-12	(21.6~26.4V)	12V	84mA	6KVDC	-40~+85°C
MDS01N-15		15V	67mA		

SIP7, Medical Grade Unregulated 1W, ±10% V_{in}, Dual V_{out} MDD01

Model No.	V _{in}	V _{out}	I _{out}	Isolation voltage	Operating temperature
MDD01L-05		±5V	±100mA		
MDD01L-09	5V	±9V	±56mA		
MDD01L-12	(4.5~5.5V)	±12V	±42mA	6KVDC	-40~+85°C
MDD01L-15		±15V	±34mA		
MDD01M-05	12V	±5V	±100mA		
MDD01M-09		±9V	±56mA		
MDD01M-12	(10.8~13.2V)	±12V	±42mA	6KVDC	-40~+85°C
MDD01M-15		±15V	±34mA		
MDD01N-05	24V	±5V	±100mA		
MDD01N-09		±9V	±56mA		
MDD01N-12	(21.6~26.4V)	±12V	±42mA	6KVDC	-40~+85°C
MDD01N-15		±15V	±34mA		

SIP7, Medical Grade Unregulated 2W, ±10% V_{in}, Single V_{out} MDS02

Model No.	V _{in}	V _{out}	I _{out}	Isolation voltage	Operating temperature
MDS02L-05		5V	400mA		
MDS02L-12	5V	12V	167mA		
MDS02L-15	(4.5~5.5V)	15V	133mA	6KVDC	-40~+85°C
MDS02M-05	12V	5V	400mA		
MDS02M-12	(10.8~13.2V)	12V	167mA		
MDS02M-15		15V	133mA	6KVDC	-40~+85°C
MDS02N-05	24V	5V	400mA		
MDS02N-12	(21.6~26.4V)	12V	167mA		
MDS02N-15		15V	133mA	6KVDC	-40~+85°C

SIP7, Medical Grade Unregulated 2W, ±10% V_{in}, Dual V_{out} MDD02

Model No.	V _{in}	V _{out}	I _{out}	Isolation voltage	Operating temperature
MDD02L-05		±5V	±200mA		
MDD02L-09	5V	±9V	±111mA		
MDD02L-12	(4.5~5.5V)	±12V	±83mA	6KVDC	-40~+85°C
MDD02L-15		±15V	±67mA		
MDD02M-05	12V	±5V	±200mA		
MDD02M-09		±9V	±111mA		
MDD02M-12	(10.8~13.2V)	±12V	±83mA	6KVDC	-40~+85°C
MDD02M-15		±15V	±67mA		
MDD02N-05	24V	±5V	±200mA		
MDD02N-09		±9V	±111mA		
MDD02N-12	(21.6~26.4V)	±12V	±83mA	6KVDC	-40~+85°C
MDD02N-15		±15V	±67mA		

DC/DC Converter 3~6W Medical Grade DIP Module Type



MDS03
(1.25"x 0.8"x 0.48")



MDD03
(1.25"x 0.8"x 0.48")



MDS06
(1.25"x 0.8"x 0.48")



MDD06
(1.25"x 0.8"x 0.48")



NEW

MDS03/06 Series

MDD03/06 Series

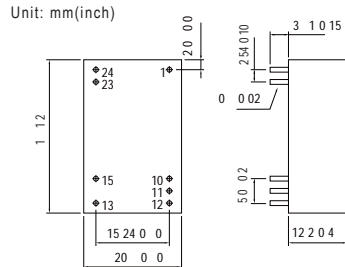

Pin No.	Pin-Out	
	MDS03/06 (Single output)	MDD03/06 (Dual output)
1	+Vin	+Vin
10	No pin	No pin
11	No pin	Common
12	-Vout	No pin
13	+Vout	-Vout
15	No pin	+Vout
23,24	-Vin	-Vin

DIP 24, Medical Grade Regulated 3W, 4:1 V_{in} , Single V_{out} MDS03 EMI UK CE

Model No.	V_{in}	V_{out}	I_{out}	Isolation voltage	Operating temperature
MDS03F-05	12V, 48V (9~36V)	5V	600mA	6KVDC	-40~+90
MDS03F-12		12V	250mA		
MDS03F-15		15V	200mA		
MDS03G-05	24V, 48V (18~75V)	5V	600mA	6KVDC	-40~+90
MDS03G-12		12V	250mA		
MDS03G-15		15V	200mA		

DIP 24, Medical Grade Regulated 3W, 4:1 V_{in} , Dual V_{out} MDD03 EMI UK CE

Model No.	V_{in}	V_{out}	I_{out}	Isolation voltage	Operating temperature
MDD03F-05	12V, 24V (9~36V)	±5V	±300mA	6KVDC	-40~+90
MDD03F-12		±12V	±125mA		
MDD03F-15		±15V	±100mA		
MDD03G-05	24V, 48V (18~75V)	±5V	±300mA	6KVDC	-40~+90
MDD03G-12		±12V	±125mA		
MDD03G-15		±15V	±100mA		

DIP 24, Medical Grade Regulated 6W, 4:1 V_{in} , Single V_{out} MDS06 EMI UK CE

Model No.	V_{in}	V_{out}	I_{out}	Isolation voltage	Operating temperature
MDS06F-05	12V, 24V (9~36V)	5V	1200mA	6KVDC	-40~+90
MDS06F-12		12V	500mA		
MDS06F-15		15V	400mA		
MDS06G-05	24V, 28V (18~75V)	5V	1200mA	6KVDC	-40~+90
MDS06G-12		12V	500mA		
MDS06G-15		15V	400mA		

DIP 24, Medical Grade Regulated 6W, 4:1 V_{in} , Dual V_{out} MDD06 EMI UK CE

Model No.	V_{in}	V_{out}	I_{out}	Isolation voltage	Operating temperature
MDD06F-05	12V, 24V (9~36V)	±5V	±600mA	6KVDC	-40~+90
MDD06F-12		±12V	±250mA		
MDD06F-15		±15V	±200mA		
MDD06G-05	24V, 48V (18~75V)	±5V	±600mA	6KVDC	-40~+90
MDD06G-12		±12V	±250mA		
MDD06G-15		±15V	±200mA		

DC/DC Converter 15~20W Medical Grade 2"x1" Module Type



NEW



MDS15
(2"x 1"x 0.47")



MDS20
(2"x 1"x 0.47")



MDS15/20 Series

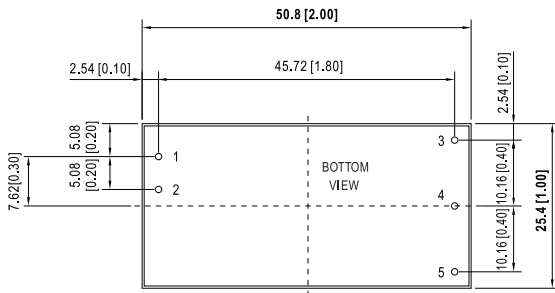

Unit: mm(inch)

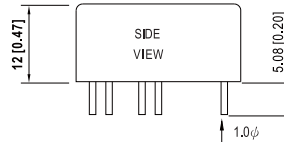

Pin No.	Output
1	+Vin
2	-Vin
3	+Vout
4	No Pin
5	-Vout

DIP7, Medical Grade Regulated 15W, 2:1 V_{in} , Single V_{out}

MDS15

Model No.	V_{in}	V_{out}	I_{out}	Isolation voltage	Operating temperature
MDS15A-05	12V (9~18V)	5V	3000mA	4KVAC	-40~+90°C
MDS15A-12		12V	1250mA		
MDS15A-15		15V	1000mA		
MDS15A-24		24V	625mA		
MDS15B-05	24V (18~36V)	5V	3000mA	4KVAC	-40~+90°C
MDS15B-12		12V	1250mA		
MDS15B-15		15V	1000mA		
MDS15B-24		24V	625mA		
MDS15C-05	48V (36~75V)	5V	3000mA	4KVAC	-40~+90°C
MDS15C-12		12V	1250mA		
MDS15C-15		15V	1000mA		
MDS15C-24		24V	625mA		

DIP7, Medical Grade Regulated 20W, 2:1 V_{in} , Single V_{out}

MDS20

Model No.	V_{in}	V_{out}	I_{out}	Isolation voltage	Operating temperature
MDS20A-05	12V (9~18V)	5V	4000mA	4KVAC	-40~+90°C
MDS20A-12		12V	1670mA		
MDS20A-15		15V	1333mA		
MDS20A-24		24V	833mA		
MDS20B-05	24V (18~36V)	5V	4000mA	4KVAC	-40~+90°C
MDS20B-12		12V	1670mA		
MDS20B-15		15V	1333mA		
MDS20B-24		24V	833mA		
MDS20C-05	48V (36~75V)	5V	4000mA	4KVAC	-40~+90°C
MDS20C-12		12V	1670mA		
MDS20C-15		15V	1333mA		
MDS20C-24		24V	833mA		

DC/DC Converter

Non-Isolated 1A&12A Ultra Compact SMD Type



NEW



SPOL-01
(12.4x 12.4x 4mm)



SPOL-12P
SPOL-12N
(12.19x 12.19x 3.1mm)



SPOL-01 Series

Unit: mm(inch)

Pin-Out			
Pin No	Function	Pin No.	Function
1	R.C	4	Vout
2	Vin	5,8,9,10,12	N.C
3,7,11	GND	6	Trim

SPOL-12 Series

Unit: mm(inch)

Pin-Out			
Pin No	Single	Pin No.	Single
1	ON/OFF	8,14,15,16,17	NC
2	Vin	9	SEQ
3,7	GND	10	P.G
4	Vout	11	SYNC
5	VS+(sense)	12	VS-(sense)
6	Trim	13	SIG_GND

1A, Non-isolated **SPOL-01**

Model No.	V _{in}	V _{out}	I _{out}	Operating temperature
SPOL-01	Nom. 12V (3~14V)	Nom. 5V (0.9~5.5V) Programmable	1A	-40~+82°C

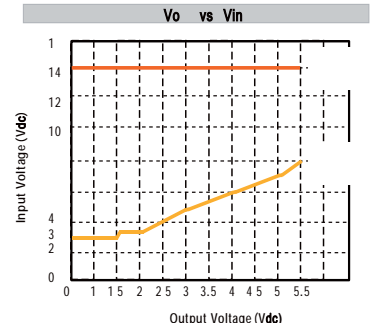

1A, Non-isolated **SPOL-12**

Model No.	V _{in}	V _{out}	I _{out}	Operating temperature
SPOL-12□	Nom. 12V (3~14V)	Nom. 5V (0.6~5.5V) Programmable	12A	-40~+90°C

□ = P,N;
P:Positive, N:Negative

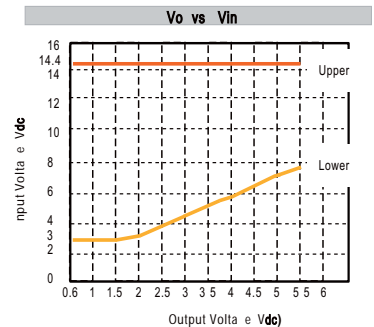

ack n	eel ack n		
	M er eel CS	S OL 01	0
		S OL 12	0

NEW



N78-PV
(16x 10.5x 7.5mm)



N78-PH
(16x 10.5x 7.5mm)



N78-C
(17.5x 11.5x 9mm)



N78-CW
(17.5x 11.5x 9mm)

N78 Series

※ V type

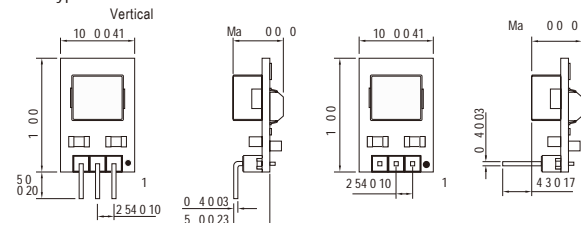

Pin-Out		
Pin No.	N78xx - PV/PH	
	+Output	-Output
1	+Vin	+Vin
2	GND	-Vout
3	+Vout	GND

※ C type

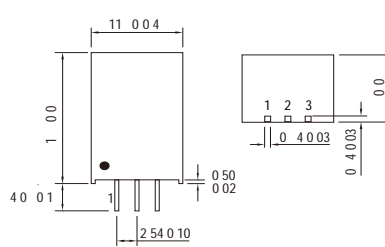

Pin-Out		
Pin No.	N78xx-C	
	+Output	-Output
1	+Vin	+Vin
2	GND	-Vout
3	+Vout	GND

※ C type

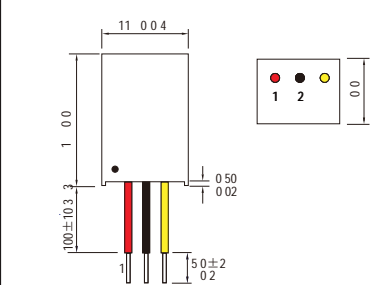

Pin-Out		
Pin No.	N78xx - CW	
	+Output	-Output
1(Red)	+Vin	+Vin
2(Black)	GND	-Vout
3(Yellow)	+Vout	GND

N78



Model No.	V_{in}	V_{out}	I_{out}	Operating temperature
N7803-1□	12V (6~36V)	3.3V	1000mA	-40~+85°C
N7805-1□	12V (8~36V)	5V	1000mA	
	12V (8~27V)	-5V	500mA	
N7809-1□	24V (13~36V)	9V	1000mA	
N7812-1□	24V (16~36V)	12V	1000mA	
	12V (8~20V)	-12V	1000mA	
N7815-1□	24V (20~36V)	15V	1000mA	
	12V (8~18V)	-15V	300A	

□ = PV, PH, C, CW

Typical Applications

Positive output application circuit

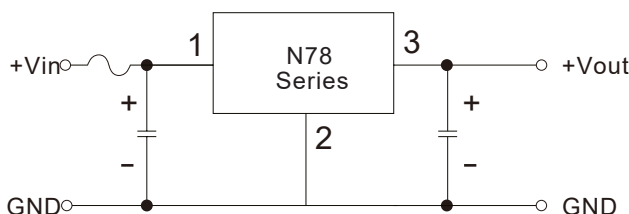

Negative output application circuit

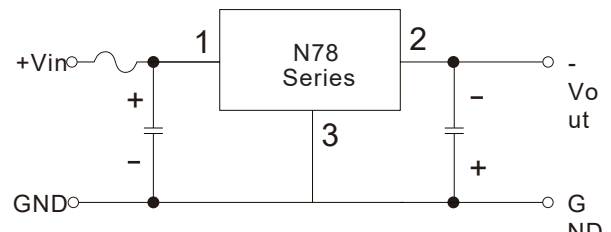

DC/DC Converter

1W SMD Module Type



NEW

SMT01

(0.6" x 0.43" x 0.28")



SBTN01

(0.5" x 0.43" x 0.28")



SFTN01

(0.6" x 0.42" x 0.28")

SMT01 Series	SBTN01 Series	SFTN01 Series																																				
 <table border="1"> <thead> <tr> <th>Pin No.</th> <th>Output</th> </tr> </thead> <tbody> <tr><td>1</td><td>-Vin</td></tr> <tr><td>5</td><td>-Vout</td></tr> <tr><td>6</td><td>+Vout</td></tr> <tr><td>12</td><td>+Vin</td></tr> <tr><td>2,3,7,8,10,11</td><td>N.C.</td></tr> </tbody> </table>	Pin No.	Output	1	-Vin	5	-Vout	6	+Vout	12	+Vin	2,3,7,8,10,11	N.C.	 <table border="1"> <thead> <tr> <th>Pin No.</th> <th>Output</th> </tr> </thead> <tbody> <tr><td>1</td><td>-Vin</td></tr> <tr><td>2</td><td>+Vin</td></tr> <tr><td>4</td><td>-Vout</td></tr> <tr><td>5</td><td>+Vout</td></tr> <tr><td>8</td><td>N.C.</td></tr> </tbody> </table>	Pin No.	Output	1	-Vin	2	+Vin	4	-Vout	5	+Vout	8	N.C.	 <table border="1"> <thead> <tr> <th>Pin No.</th> <th>Output</th> </tr> </thead> <tbody> <tr><td>1</td><td>-Vin</td></tr> <tr><td>2</td><td>+Vin</td></tr> <tr><td>5</td><td>-Vout</td></tr> <tr><td>8</td><td>+Vout</td></tr> <tr><td>3,6,7,10,11,12</td><td>N.C.</td></tr> </tbody> </table>	Pin No.	Output	1	-Vin	2	+Vin	5	-Vout	8	+Vout	3,6,7,10,11,12	N.C.
Pin No.	Output																																					
1	-Vin																																					
5	-Vout																																					
6	+Vout																																					
12	+Vin																																					
2,3,7,8,10,11	N.C.																																					
Pin No.	Output																																					
1	-Vin																																					
2	+Vin																																					
4	-Vout																																					
5	+Vout																																					
8	N.C.																																					
Pin No.	Output																																					
1	-Vin																																					
2	+Vin																																					
5	-Vout																																					
8	+Vout																																					
3,6,7,10,11,12	N.C.																																					

Regulated 1W, 2:1 V_{in} , Single V_{out} **NEW** SMT01

Model No.	V_{in}	V_{out}	I_{out}	Isolation voltage	Operating temperature
SMT01A-05	12V (9~18V)	5V	200mA	1.5KVDC	-40~+90°C
SMT01A-12		12V	83mA		
SMT01A-15		15V	67mA		
SMT01B-05	24V (18~36V)	5V	200mA	1.5KVDC	-40~+90°C
SMT01B-12		12V	83mA		
SMT01B-15		15V	67mA		
SMT01C-05	48V (36~72V)	5V	200mA	1.5KVDC	-40~+90°C
SMT01C-12		12V	83mA		
SMT01C-15		15V	67mA		

Unregulated 1W, $\pm 10\%$ V_{in} , Single V_{out} SBTN01

Model No.	V_{in}	V_{out}	I_{out}	Isolation voltage	Operating temperature
SBTN01L-05	5V (4.5~5.5V)	5V	200mA	1.5KVDC	-40~+90°C
SBTN01L-09		9V	111mA		
SBTN01L-12		12V	84mA		
SBTN01L-15		15V	67mA		
SBTN01M-05	12V (10.8~13.2V)	5V	200mA	1.5KVDC	-40~+90°C
SBTN01M-09		9V	111mA		
SBTN01M-12		12V	84mA		
SBTN01M-15		15V	67mA		
SBTN01N-05	24V (21.6~26.4V)	5V	200mA	1.5KVDC	-40~+90°C
SBTN01N-09		9V	111mA		
SBTN01N-12		12V	84mA		
SBTN01N-15		15V	67mA		

▶-40~+105°C operating temperature with continuous short protection (optional model for SBTN01x-xxSC).

Unregulated 1W, $\pm 10\%$ V_{in} , Single V_{out} SFTN01

Model No.	V_{in}	V_{out}	I_{out}	Isolation voltage	Operating temperature
SFTN01L-05	5V (4.5~5.5V)	5V	200mA	3KVDC	-40~+90°C
SFTN01L-09		9V	111mA		
SFTN01L-12		12V	84mA		
SFTN01L-15		15V	67mA		
SFTN01M-05	12V (10.8~13.2V)	5V	200mA	3KVDC	-40~+90°C
SFTN01M-09		9V	111mA		
SFTN01M-12		12V	84mA		
SFTN01M-15		15V	67mA		
SFTN01N-05	24V (21.6~26.4V)	5V	200mA	3KVDC	-40~+90°C
SFTN01N-09		9V	111mA		
SFTN01N-12		12V	84mA		
SFTN01N-15		15V	67mA		

▶-40~+105°C operating temperature with continuous short protection (optional model for SFTN01x-xxSC).



DETNO1
(0.6"x 0.43"x 0.28")



SFTN02
(0.6"x 0.43"x 0.28")



DETNO2
(0.6"x 0.43"x 0.28")

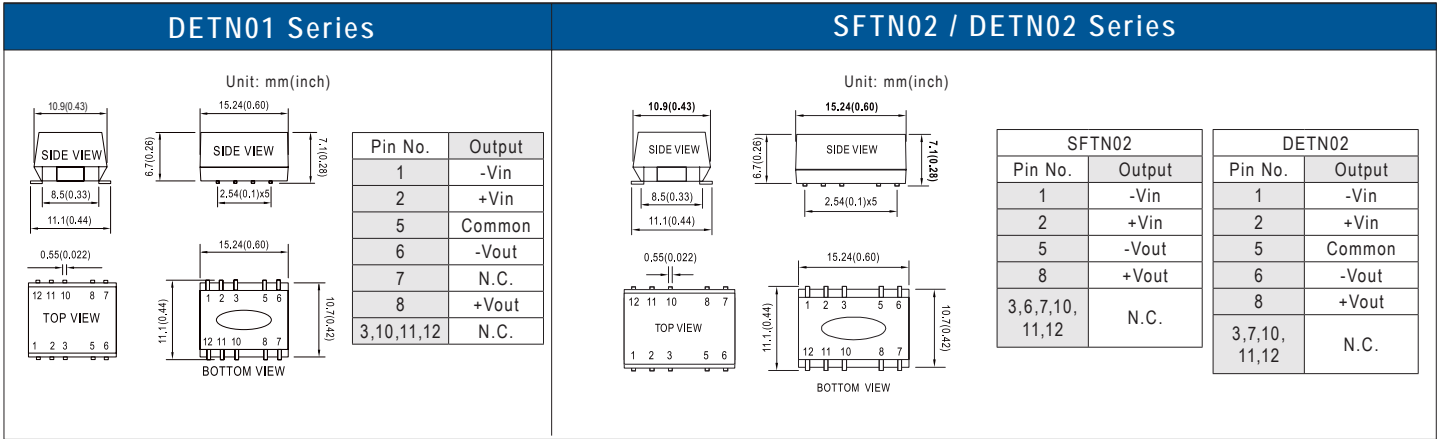

Unregulated 1W, ±10% V _{in} , Dual V _{out}				DETNO1	us EAC CB UK CA CE
Model No.	V _{in}	V _{out}	I _{out}	Isolation voltage	Operating temperature
DETNO1L-05	5V (4.5~5.5V)	±5V	±100mA	3KVDC	-40~+90°C
DETNO1L-12		±12V	±42mA		
DETNO1L-15		±15V	±34mA		
DETNO1M-05	12V (10.8~13.2V)	±5V	±100mA	3KVDC	-40~+90°C
DETNO1M-12		±12V	±42mA		
DETNO1M-15		±15V	±34mA		
DETNO1N-05	24V (21.6~26.4V)	±5V	±100mA	3KVDC	-40~+90°C
DETNO1N-12		±12V	±42mA		
DETNO1N-15		±15V	±34mA		

▶ -40~+105°C operating temperature with continuous short protection (optional model for DETNO1x-xxSC).

Unregulated 2W, ±10% V _{in} , Single V _{out}				SFTN02	EAC UK CA CE
Model No.	V _{in}	V _{out}	I _{out}	Isolation voltage	Operating temperature
SFTN02L-05	5V (4.5~5.5V)	5V	400mA	3KVDC	-40~+100°C
SFTN02L-12		12V	167mA		
SFTN02L-15		15V	133mA		
SFTN02M-05	12V (10.8~13.2V)	5V	400mA	3KVDC	-40~+100°C
SFTN02M-12		12V	167mA		
SFTN02M-15		15V	133mA		
SFTN02N-05	24V (21.6~26.4V)	5V	400mA	3KVDC	-40~+100°C
SFTN02N-12		12V	167mA		
SFTN02N-15		15V	133mA		

▶ -40~+105°C operating temperature with continuous short protection (optional model for SFTN02-x-xxSC).

Unregulated 2W, ±10% V _{in} , Dual V _{out}				DETNO2	EAC UK CA CE
Model No.	V _{in}	V _{out}	I _{out}	Isolation voltage	Operating temperature
DETNO2L-05	5V (4.5~5.5V)	±5V	±200mA	3KVDC	-40~+100°C
DETNO2L-12		±12V	±84mA		
DETNO2L-15		±15V	±67mA		
DETNO2M-05	12V (10.8~13.2V)	±5V	±200mA	3KVDC	-40~+100°C
DETNO2M-12		±12V	±84mA		
DETNO2M-15		±15V	±67mA		
DETNO2N-05	24V (21.6~26.4V)	±5V	±200mA	3KVDC	-40~+100°C
DETNO2N-12		±12V	±84mA		
DETNO2N-15		±15V	±67mA		

▶ -40~+105°C operating temperature with continuous short protection (optional model for DETNO2x-xxSC).

DC/DC Converter 1~2W SIP Unregulated Module Type



SMU01
(0.46"x 0.24"x 0.4")



SMU02
(0.46"x 0.3"x 0.4")



SPU01
(0.77"x 0.24"x 0.4") 5/12V_{in}
(0.77"x 0.28"x 0.4") 24V_{in}



DPU01
(0.77"x 0.24"x 0.4") 5/12V_{in}
(0.77"x 0.28"x 0.4") 24V_{in}

SMU01 / SMU02 Series

SPU01 / DPU01 Series

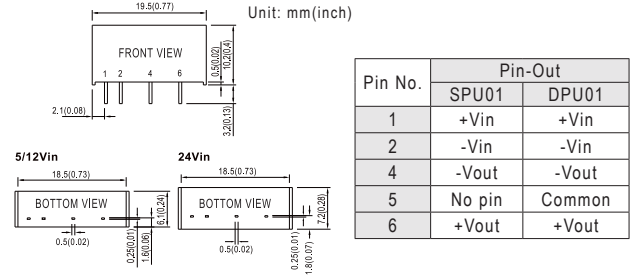
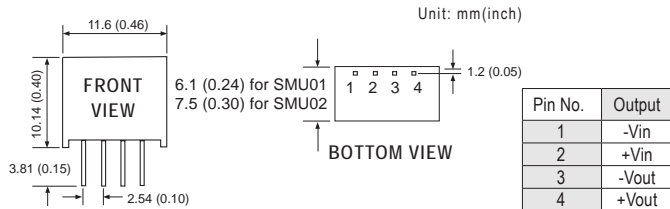

SIP4, Unregulated 1W, ±10% V_{in}, Single V_{out}

SMU01



Model No.	V _{in}	V _{out}	I _{out}	Isolation voltage	Operating temperature
SMU01L-05	5V (4.5~5.5V)	5V	200mA	1.5KVDC	-40~+90°C
SMU01L-09		9V	110mA		
SMU01L-12		12V	84mA		
SMU01L-15		15V	67mA		
SMU01M-05	12V (10.8~13.2V)	5V	200mA	1.5KVDC	-40~+90°C
SMU01M-09		9V	110mA		
SMU01M-12		12V	84mA		
SMU01M-15		15V	67mA		
SMU01N-05	24V (21.6~26.4V)	5V	200mA	1.5KVDC	-40~+90°C
SMU01N-09		9V	110mA		
SMU01N-12		12V	84mA		
SMU01N-15		15V	67mA		

SIP4, Unregulated 2W, ±10% V_{in}, Single V_{out}

SMU02



Model No.	V _{in}	V _{out}	I _{out}	Isolation voltage	Operating temperature
SMU02L-05	5V (4.5~5.5V)	5V	400mA	1.5KVDC	-40~+85°C
SMU02L-12		12V	167mA		
SMU02L-15		15V	133mA		
SMU02M-05	12V (10.8~13.2V)	5V	400mA	1.5KVDC	-40~+85°C
SMU02M-12		12V	167mA		
SMU02M-15		15V	133mA		
SMU02N-05	24V (21.6~26.4V)	5V	400mA	1.5KVDC	-40~+85°C
SMU02N-12		12V	167mA		
SMU02N-15		15V	133mA		

SIP6, Unregulated 1W, ±10% V_{in}, Single V_{out}

SPU01



Model No.	V _{in}	V _{out}	I _{out}	Isolation voltage	Operating temperature
SPU01L-05	5V (4.5~5.5V)	5V	200mA	1.5KVDC	-40~+90°C
SPU01L-12		12V	84mA		
SPU01L-15		15V	67mA		
SPU01M-05	12V (10.8~13.2V)	5V	200mA	1.5KVDC	-40~+90°C
SPU01M-12		12V	84mA		
SPU01M-15		15V	67mA		
SPU01N-05	24V (21.6~26.4V)	5V	200mA	1.5KVDC	-40~+90°C
SPU01N-12		12V	84mA		
SPU01N-15		15V	67mA		

SIP6, Unregulated 1W, ±10% V_{in}, Dual V_{out}

DPU01



Model No.	V _{in}	V _{out}	I _{out}	Isolation voltage	Operating temperature
DPU01L-05	5V (4.5~5.5V)	±5V	±100mA	1.5KVDC	-40~+90°C
DPU01L-12		±12V	±42mA		
DPU01L-15		±15V	±33mA		
DPU01M-05	12V (10.8~13.2V)	±5V	±100mA	1.5KVDC	-40~+90°C
DPU01M-12		±12V	±42mA		
DPU01M-15		±15V	±33mA		
DPU01N-05	24V (21.6~26.4V)	±5V	±100mA	1.5KVDC	-40~+90°C
DPU01N-12		±12V	±42mA		
DPU01N-15		±15V	±33mA		

DC/DC Converter 2~3W SIP Unregulated Module Type



SPUN02
(0.77"x 0.28"x 0.4")

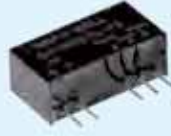

DPUN02
(0.77"x 0.28"x 0.4")



SPU03
(0.77"x 0.3"x 0.4")

SPUN02 / DPUN02 Series

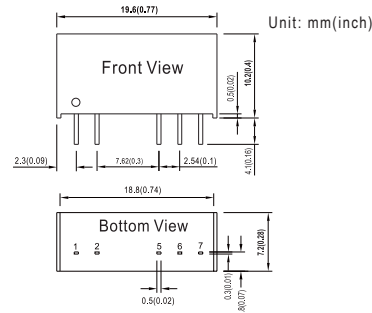

Pin No.	Pin-Out	
	SPUN02	DPUN02
1	+Vin	+Vin
2	-Vin	-Vin
4	-Vout	-Vout
5	No pin	Common
6	+Vout	+Vout

SPU03 Series

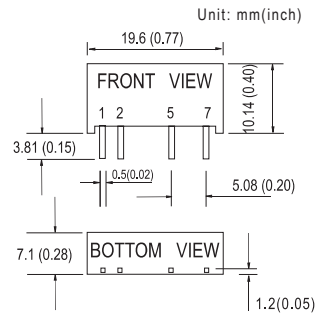

Pin No.	Output
1	+Vin
2	-Vin
5	-Vout
7	+Vout

SIP7, Unregulated 2W, ±10% V_{in}, Single V_{out} SPUN02

Model No.	V _{in}	V _{out}	I _{out}	Isolation voltage	Operating temperature
SPUN02L-05	5V (4.5~5.5V)	5V	400mA	3KVDC	-40~+105°C
SPUN02L-12		12V	167mA		
SPUN02L-15		15V	134mA		
SPUN02M-05	12V (10.8~13.2V)	5V	400mA	3KVDC	-40~+105°C
SPUN02M-12		12V	167mA		
SPUN02M-15		15V	134mA		
SPUN02N-05	24V (21.6~26.4V)	5V	400mA	3KVDC	-40~+105°C
SPUN02N-12		12V	167mA		
SPUN02N-15		15V	134mA		

SIP7, Unregulated 2W, ±10% V_{in}, Dual V_{out} DPUN02

Model No.	V _{in}	V _{out}	I _{out}	Isolation voltage	Operating temperature
DPUN02L-05	5V (4.5~5.5V)	±5V	±200mA	3KVDC	-40~+105°C
DPUN02L-12		±12V	±83mA		
DPUN02L-15		±15V	±67mA		
DPUN02M-05	12V (10.8~13.2V)	±5V	±200mA	3KVDC	-40~+105°C
DPUN02M-12		±12V	±83mA		
DPUN02M-15		±15V	±67mA		
DPUN02N-05	24V (21.6~26.4V)	±5V	±200mA	3KVDC	-40~+105°C
DPUN02N-12		±12V	±83mA		
DPUN02N-15		±15V	±67mA		

SIP7, Unregulated 3W, ±10% V_{in}, Single V_{out} SPU03

Model No.	V _{in}	V _{out}	I _{out}	Isolation voltage	Operating temperature
SPU03L-05	5V (4.5~5.5V)	5V	600mA	3KVDC	-40~+90°C
SPU03L-12		12V	250mA		
SPU03L-15		15V	200mA		
SPU03M-05	12V (10.8~13.2V)	5V	600mA	3KVDC	-40~+90°C
SPU03M-12		12V	250mA		
SPU03M-15		15V	200mA		
SPU03N-05	24V (21.6~26.4V)	5V	600mA	3KVDC	-40~+90°C
SPU03N-12		12V	250mA		
SPU03N-15		15V	200mA		

DC/DC Converter

1W SIP Regulated Module Type



SPRN01
(0.77"x 0.28"X0.4")



DPRN01
(0.77"x 0.28"X0.4")



SPA01
(0.69"x 0.3"X0.44")

SPRN01 / DPRN01 Series

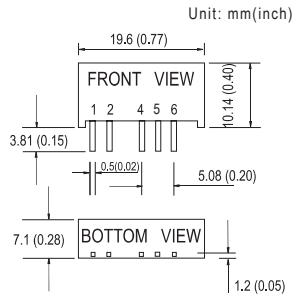

Pin No.	Pin-Out	
	SPRN01	DPRN01
1	+Vin	+Vin
2	-Vin	-Vin
4	-Vout	-Vout
5	No pin	Common
6	+Vout	+Vout

SPA01 Series

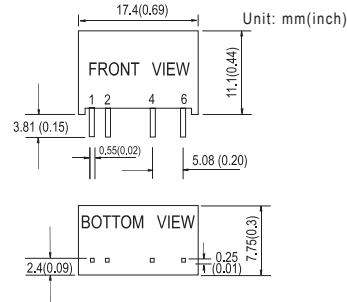

Pin No.	Output
1	-Vin
2	+Vin
4	+Vout
6	-Vout

Regulated 1W, $\pm 10\%$ V_{in} , Single V_{out}

SPRN01



Model No.	V_{in}	V_{out}	I_{out}	Isolation voltage	Operating temperature
SPRN01L-05	5V (4.75~5.5V)	5V	200mA	1.5KVDC	-40~+90°C
SPRN01L-12		12V	84mA		
SPRN01L-15		15V	67mA		
SPRN01M-05	12V (11.4~13.2V)	5V	200mA	1.5KVDC	-40~+90°C
SPRN01M-12		12V	84mA		
SPRN01M-15		15V	67mA		
SPRN01N-05	24V (22.8~26.4V)	5V	200mA	1.5KVDC	-40~+90°C
SPRN01N-12		12V	84mA		
SPRN01N-15		15V	67mA		
SPRN01O-05	48V (45.6~52.8V)	5V	200mA	1.5KVDC	-40~+90°C
SPRN01O-12		12V	84mA		
SPRN01O-15		15V	67mA		

Regulated 1W, $\pm 10\%$ V_{in} , Dual V_{out}

DPRN01



Model No.	V_{in}	V_{out}	I_{out}	Isolation voltage	Operating temperature
DPRN01L-12	5V (4.75~5.5V)	$\pm 12V$	42mA	1.5KVDC	-40~+90°C
DPRN01L-15		$\pm 15V$	34mA		
DPRN01M-12	12V (11.4~13.2V)	$\pm 12V$	42mA	1.5KVDC	-40~+90°C
DPRN01M-15		$\pm 15V$	34mA		
DPRN01N-12	24V (22.8~26.4V)	$\pm 12V$	42mA	1.5KVDC	-40~+90°C
DPRN01N-15		$\pm 15V$	34mA		
DPRN01O-12	48V (45.6~52.8V)	$\pm 12V$	42mA	1.5KVDC	-40~+90°C
DPRN01O-15		$\pm 15V$	34mA		

Regulated 1W, 2:1 V_{in} , Single V_{out}

SPA01



Model No.	V_{in}	V_{out}	I_{out}	Isolation voltage	Operating temperature
SPA01A-05	12V (9~18V)	5V	200mA	1.5KVDC	-40~+90°C
SPA01A-12		12V	83mA		
SPA01A-15		15V	67mA		
SPA01B-05	24V (18~36V)	5V	200mA	1.5KVDC	-40~+90°C
SPA01B-12		12V	83mA		
SPA01B-15		15V	67mA		
SPA01C-05	48V (36~72V)	5V	200mA	1.5KVDC	-40~+90°C
SPA01C-12		12V	83mA		
SPA01C-15		15V	67mA		

DC/DC Converter 2~9W SIP Regulated Module Type

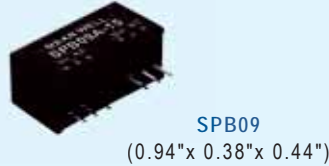

SPAN02 / DPAN02 Series

SPB09 / DPB09 Series

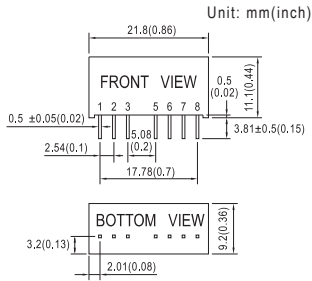

Pin No.	Pin-Out	
	SPAN02	DPAN02
1	-Vin	-Vin
2	+Vin	+Vin
3	R.C.	R.C.
5	N.C.	N.C.
6	+Vout	+Vout
7	-Vout	Common
8	N.C.	-Vout

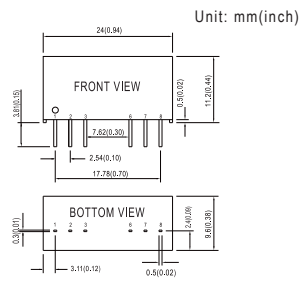

Pin No.	Pin-Out	
	SPB09	DPB09
1	-Vin	-Vin
2	+Vin	+Vin
3	R.C.	R.C.
6	+Vout	+Vout
7	-Vout	Common
8	N.C.	-Vout

SIP8, Regulated 2W, 2:1 V_{in}, Single V_{out} SPAN02

Model No.	V _{in}	V _{out}	I _{out}	Isolation voltage	Operating temperature
SPAN02E-03	5V (4.5~9V)	3.3V	500mA	1.5KVDC	-40~+90°C
SPAN02E-05		5V	400mA		
SPAN02E-12		12V	167mA		
SPAN02E-15		15V	134mA		
SPAN02A-03	12V (9~18V)	3.3V	500mA	1.5KVDC	-40~+90°C
SPAN02A-05		5V	400mA		
SPAN02A-12		12V	167mA		
SPAN02A-15		15V	134mA		
SPAN02B-03	24V (18~36V)	3.3V	500mA	1.5KVDC	-40~+90°C
SPAN02B-05		5V	400mA		
SPAN02B-12		12V	167mA		
SPAN02B-15		15V	134mA		
SPAN02C-03	48V (36~75V)	3.3V	500mA	1.5KVDC	-40~+90°C
SPAN02C-05		5V	400mA		
SPAN02C-12		12V	167mA		
SPAN02C-15		15V	134mA		

SIP8, Regulated 9W, 2:1 V_{in}, Single V_{out} SPB09

Model No.	V _{in}	V _{out}	I _{out}	Isolation voltage	Operating temperature
SPB09A-03	12V (9~18V)	3.3V	2000mA	1.5KVDC	-40~+90°C
SPB09A-05		5V	1600mA		
SPB09A-12		12V	750mA		
SPB09A-15		15V	600mA		
SPB09A-24	24V (18~36V)	24V	375mA	1.5KVDC	-40~+90°C
SPB09B-03		3.3V	2000mA		
SPB09B-05		5V	1600mA		
SPB09B-12		12V	750mA		
SPB09B-15	24V	15V	600mA	1.5KVDC	-40~+90°C
SPB09B-24		24V	375mA		
SPB09C-03		3.3V	2000mA		
SPB09C-05		5V	1600mA		
SPB09C-12	48V (36~75V)	12V	750mA	1.5KVDC	-40~+90°C
SPB09C-15		15V	600mA		
SPB09C-24		24V	375mA		

SIP8, Regulated 2W, 2:1 V_{in}, Dual V_{out} DPAN02

Model No.	V _{in}	V _{out}	I _{out}	Isolation voltage	Operating temperature
DPAN02E-05	5V (4.5~9V)	±5V	±200mA	1.5KVDC	-40~+90°C
DPAN02E-12		±12V	±83mA		
DPAN02E-15		±15V	±67mA		
DPAN02A-05	12V (9~18V)	±5V	±200mA	1.5KVDC	-40~+90°C
DPAN02A-12		±12V	±83mA		
DPAN02A-15		±15V	±67mA		
DPAN02B-05	24V (18~36V)	±5V	±200mA	1.5KVDC	-40~+90°C
DPAN02B-12		±12V	±83mA		
DPAN02B-15		±15V	±67mA		
DPAN02C-05	48V (36~75V)	±5V	±200mA	1.5KVDC	-40~+90°C
DPAN02C-12		±12V	±83mA		
DPAN02C-15		±15V	±67mA		

SIP8, Regulated 9W, 2:1 V_{in}, Dual V_{out} DPB09

Model No.	V _{in}	V _{out}	I _{out}	Isolation voltage	Operating temperature
DPB09A-05	12V (9~18V)	±5V	±800mA	1.5KVDC	-40~+90°C
DPB09A-12		±12V	±375mA		
DPB09A-15		±15V	±300mA		
DPB09B-05	24V (18~36V)	±5V	±800mA	1.5KVDC	-40~+90°C
DPB09B-12		±12V	±375mA		
DPB09B-15		±15V	±300mA		
DPB09C-05	48V (36~75V)	±5V	±800mA	1.5KVDC	-40~+90°C
DPB09C-12		±12V	±375mA		
DPB09C-15		±15V	±300mA		

DC/DC Converter 3~6W SIP Regulated Module Type



SPBW03
(0.86"x 0.36"x 0.44")



DPBW03
(0.86"x 0.36"x 0.44")



SPBW06
(0.86"x 0.36"x 0.44")



DPBW06
(0.86"x 0.36"x 0.44")

SPBW03 / DPBW03 Series

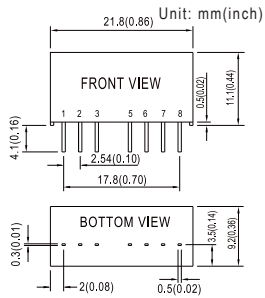

Pin No.	Pin-Out	
	SPBW03	DPBW03
1	-Vin	-Vin
2	+Vin	+Vin
3	R.C.	R.C.
5	N.C.	N.C.
6	+Vout	+Vout
7	-Vout	Common
8	N.C.	-Vout

SPBW06 / DPBW06 Series

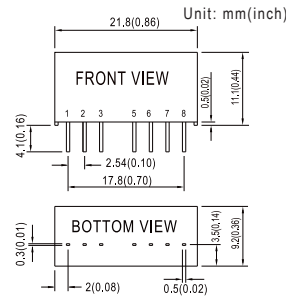

Pin No.	Pin-Out	
	SPBW06	DPBW06
1	-Vin	-Vin
2	+Vin	+Vin
3	R.C.	R.C.
5	N.C.	N.C.
6	+Vout	+Vout
7	-Vout	Common
8	N.C.	-Vout

SIP8, Regulated 3W, 4:1 V_{in} , Single V_{out}

SPBW03

Model No.	V_{in}	V_{out}	I_{out}	Isolation voltage	Operating temperature
SPBW03F-03		3.3V	700mA		
SPBW03F-05	12V, 24V	5V	600mA	1.5KVDC	-40~+85°C
SPBW03F-12	(9~36V)	12V	250mA		
SPBW03F-15		15V	200mA		
SPBW03G-03		3V	700mA		
SPBW03G-05	24V, 48V	5V	600mA	1.5KVDC	-40~+85°C
SPBW03G-12	(18~75V)	12V	250mA		
SPBW03G-15		15V	200mA		

SIP8, Regulated 3W, 4:1 V_{in} , Dual V_{out}

DPBW03

Model No.	V_{in}	V_{out}	I_{out}	Isolation voltage	Operating temperature
DPBW03F-05		±5V	±300mA		
DPBW03F-12	12V, 24V	±12V	±125mA	1.5KVDC	-40~+85°C
DPBW03F-15	(9~36V)	±15V	±100mA		
DPBW03G-05		±5V	±300mA		
DPBW03G-12	24V, 48V	±12V	±125mA	1.5KVDC	-40~+85°C
DPBW03G-15	(18~75V)	±15V	±100mA		
DPBW03G-15		±15V	±100mA		

SIP8, Regulated 6W, 4:1 V_{in} , Single V_{out}

SPBW06

Model No.	V_{in}	V_{out}	I_{out}	Isolation voltage	Operating temperature
SPBW06F-03		3.3V	1500mA		
SPBW06F-05	12V, 24V	5V	1200mA	1.5KVDC	-40~+85°C
SPBW06F-12	(9~36V)	12V	500mA		
SPBW06F-15		15V	400mA		
SPBW06G-03		3.3V	1500mA		
SPBW06G-05	24V, 48V	5V	1200mA	1.5KVDC	-40~+85°C
SPBW06G-12	(18~75V)	12V	500mA		
SPBW06G-15		15V	400mA		

SIP8, Regulated 6W, 4:1 V_{in} , Dual V_{out}

DPBW06

Model No.	V_{in}	V_{out}	I_{out}	Isolation voltage	Operating temperature
DPBW06F-05		±5V	±600mA		
DPBW06F-12	12V, 24V	±12V	±250mA	1.5KVDC	-40~+85°C
DPBW06F-15	(9~36V)	±15V	±200mA		
DPBW06G-05		±5V	±600mA		
DPBW06G-12	24V, 48V	±12V	±250mA	1.5KVDC	-40~+85°C
DPBW06G-15	(18~75V)	±15V	±200mA		
DPBW06G-15		±15V	±200mA		

DC/DC Converter 0.5~1W DIP Unregulated Module Type



SRS
(0.89"x 0.39"x 0.33")



SUS01
(0.89"x 0.39"x 0.33")



SMA01
(0.5"x 0.4"x 0.28")

SRS / SUS01 Series

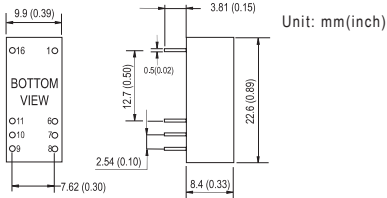

Pin No.	Output
1 & 16	+Vin
6 & 11	-Vout
7 & 10	+Vout
8 & 9	-Vin

SMA01 Series

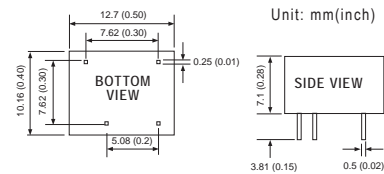

Pin No.	Output
1	-Vin
4	+Vin
5	+Vout
7	-Vout

DIP16 Package, Unregulated 0.5W, ±10% V_{in} / Single V_{out}

SRS



Model No.	V _{in}	V _{out}	I _{out}	Isolation voltage	Operating temperature
SRS-0505	5V (4.5~5.5V)	5V	100mA	1KVDC	-25~+71°C
SRS-0509		9V	56mA		
SRS-0512		12V	42mA		
SRS-0515		15V	34mA		
SRS-1205	12V (10.8~13.2V)	5V	100mA	1KVDC	-25~+71°C
SRS-1209		9V	56mA		
SRS-1212		12V	42mA		
SRS-1215		15V	34mA		
SRS-2405	24V (21.6~26.4V)	5V	100mA	1KVDC	-25~+71°C
SRS-2409		9V	56mA		
SRS-2412		12V	42mA		
SRS-2415		15V	34mA		
SRS-4805	48V (43.2~52.8V)	5V	100mA	1KVDC	-25~+71°C
SRS-4809		9V	56mA		
SRS-4812		12V	42mA		
SRS-4815		15V	34mA		

DIP16 Package, Unregulated 1W, ±10% V_{in}, Single V_{out}

SUS01



Model No.	V _{in}	V _{out}	I _{out}	Isolation voltage	Operating temperature
SUS01L-05	5V (4.5~5.5V)	5V	200mA	1KVDC	-25~+71°C
SUS01L-09		9V	111mA		
SUS01L-12		12V	84mA		
SUS01L-15		15V	67mA		
SUS01M-05	12V (10.8~13.2V)	5V	200mA	1KVDC	-25~+71°C
SUS01M-09		9V	111mA		
SUS01M-12		12V	84mA		
SUS01M-15		15V	67mA		
SUS01N-05	24V (21.6~26.4V)	5V	200mA	1KVDC	-25~+71°C
SUS01N-09		9V	111mA		
SUS01N-12		12V	84mA		
SUS01N-15		15V	67mA		
SUS01O-05	48V (43.2~52.8V)	5V	200mA	1KVDC	-25~+71°C
SUS01O-09		9V	111mA		
SUS01O-12		12V	84mA		
SUS01O-15		15V	67mA		

DIP7 Package, Unregulated 1W, ±10% V_{in}, Single V_{out}

SMA01



Model No.	V _{in}	V _{out}	I _{out}	Isolation voltage	Operating temperature
SMA01L-05	5V (4.5~5.5V)	5V	200mA	1.5KVDC	-40~+90°C
SMA01L-09		9V	110mA		
SMA01L-12		12V	84mA		
SMA01L-15		15V	67mA		
SMA01M-05	12V (10.8~13.2V)	5V	200mA	1.5KVDC	-40~+90°C
SMA01M-09		9V	110mA		
SMA01M-12		12V	84mA		
SMA01M-15		15V	67mA		
SMA01N-05	24V (21.6~26.4V)	5V	200mA	1.5KVDC	-40~+90°C
SMA01N-09		9V	110mA		
SMA01N-12		12V	84mA		
SMA01N-15		15V	67mA		

DC/DC Converter 3W DIP Regulated Module Type

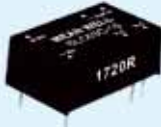

SLC03 / DLC03
(0.87"x 0.54"x 0.34")



SCWN03 / DCWN03
(1.25"x 0.8"x 0.4")

SLC03 / DLC03 Series		SCWN03 / DCWN03 Series																																															
<p>Unit: mm (inch)</p> <p>BOTTOM VIEW: 22.1(0.87) mm, 1.77(0.07) mm, 10.16(0.4) mm, 13.7(0.54) mm, 0.5(0.02) mm, 0.5(0.02) mm, 22.1(0.87) mm, 1.81(0.07) mm, 2.16(0.09) mm, 15.24(0.6) mm, 2.54(0.1) mm, 8.55(0.34) mm, 0.5(0.02) mm.</p> <p>SIDE VIEW: 22.1(0.87) mm, 1.81(0.07) mm, 2.16(0.09) mm, 15.24(0.6) mm, 2.54(0.1) mm, 8.55(0.34) mm, 0.5(0.02) mm.</p> <table border="1"> <thead> <tr> <th rowspan="2">Pin No.</th> <th colspan="2">Pin-Out</th> </tr> <tr> <th>SLC03</th> <th>DLC03</th> </tr> </thead> <tbody> <tr> <td>1</td> <td>-Vin</td> <td>-Vin</td> </tr> <tr> <td>7</td> <td>N.C.</td> <td>N.C.</td> </tr> <tr> <td>8</td> <td>N.C.</td> <td>Common</td> </tr> <tr> <td>9</td> <td>+Vout</td> <td>+Vout</td> </tr> <tr> <td>10</td> <td>-Vout</td> <td>-Vout</td> </tr> <tr> <td>16</td> <td>+Vin</td> <td>+Vin</td> </tr> </tbody> </table>		Pin No.	Pin-Out		SLC03	DLC03	1	-Vin	-Vin	7	N.C.	N.C.	8	N.C.	Common	9	+Vout	+Vout	10	-Vout	-Vout	16	+Vin	+Vin	<p>Unit: mm (inch)</p> <p>BOTTOM VIEW: 23 mm, 22 mm, 2 mm, 3 mm, 16 mm, 9 mm, 14 mm, 11 mm, 15.24(0.6) mm, 20.3(0.8) mm, 31.8(1.25) mm.</p> <p>SIDE VIEW: 2.54(0.1) mm, 1.0(0.04) mm, 5.08(0.2) mm, 3.8(0.15) mm, 10.2(0.4) mm.</p> <table border="1"> <thead> <tr> <th rowspan="2">Pin No.</th> <th colspan="2">Pin-Out</th> </tr> <tr> <th>SCWN03</th> <th>DCWN03</th> </tr> </thead> <tbody> <tr> <td>2&3</td> <td>-Vin</td> <td>-Vin</td> </tr> <tr> <td>9</td> <td>N.C.</td> <td>Common</td> </tr> <tr> <td>11</td> <td>N.C.</td> <td>-Vout</td> </tr> <tr> <td>14</td> <td>+Vout</td> <td>+Vout</td> </tr> <tr> <td>16</td> <td>-Vout</td> <td>Common</td> </tr> <tr> <td>22&23</td> <td>+Vin</td> <td>+Vin</td> </tr> </tbody> </table>		Pin No.	Pin-Out		SCWN03	DCWN03	2&3	-Vin	-Vin	9	N.C.	Common	11	N.C.	-Vout	14	+Vout	+Vout	16	-Vout	Common	22&23	+Vin	+Vin
Pin No.	Pin-Out																																																
	SLC03	DLC03																																															
1	-Vin	-Vin																																															
7	N.C.	N.C.																																															
8	N.C.	Common																																															
9	+Vout	+Vout																																															
10	-Vout	-Vout																																															
16	+Vin	+Vin																																															
Pin No.	Pin-Out																																																
	SCWN03	DCWN03																																															
2&3	-Vin	-Vin																																															
9	N.C.	Common																																															
11	N.C.	-Vout																																															
14	+Vout	+Vout																																															
16	-Vout	Common																																															
22&23	+Vin	+Vin																																															

DIP16 Package, Regulated 3W, 2:1 V_{in}, Single V_{out} SLC03



Model No.	V _{in}	V _{out}	I _{out}	Isolation voltage	Operating temperature
SLC03A-05	12V (9~18V)	5V	600mA	1.5KVDC	-40~+85°C
SLC03A-12		12V	250mA		
SLC03A-15		15V	200mA		
SLC03B-05	24V (18~36V)	5V	600mA	1.5KVDC	-40~+85°C
SLC03B-12		12V	250mA		
SLC03B-15		15V	200mA		
SLC03C-05	48V (36~75V)	5V	600mA	1.5KVDC	-40~+85°C
SLC03C-12		12V	250mA		
SLC03C-15		15V	200mA		

DIP16 Package, Regulated 3W, 2:1 V_{in}, Dual V_{out} DLC03



Model No.	V _{in}	V _{out}	I _{out}	Isolation voltage	Operating temperature
DLC03A-05	12V (9~18V)	±5V	±300mA	1.5KVDC	-40~+85°C
DLC03A-12		±12V	±125mA		
DLC03A-15		±15V	±100mA		
DLC03B-05	24V (18~36V)	±5V	±300mA	1.5KVDC	-40~+85°C
DLC03B-12		±12V	±125mA		
DLC03B-15		±15V	±100mA		
DLC03C-05	48V (36~75V)	±5V	±300mA	1.5KVDC	-40~+85°C
DLC03C-12		±12V	±125mA		
DLC03C-15		±15V	±100mA		

DIP24 Package, Regulated 3W, 2:1 V_{in}, Single V_{out} SCWN03



Model No.	V _{in}	V _{out}	I _{out}	Isolation voltage	Operating temperature
SCWN03E-03	5V (4.5~9V)	3.3V	600mA	3KVDC	-40~+90°C
SCWN03E-05		5V	600mA		
SCWN03E-12		12V	250mA		
SCWN03E-15		15V	200mA		
SCWN03A-03	12V (9~18V)	3.3V	600mA	3KVDC	-40~+90°C
SCWN03A-05		5V	600mA		
SCWN03A-12		12V	250mA		
SCWN03A-15		15V	200mA		
SCWN03B-03	24V (18~36V)	3.3V	600mA	3KVDC	-40~+90°C
SCWN03B-05		5V	600mA		
SCWN03B-12		12V	250mA		
SCWN03B-15		15V	200mA		
SCWN03C-03	48V (36~72V)	3.3V	600mA	3KVDC	-40~+90°C
SCWN03C-05		5V	600mA		
SCWN03C-12		12V	250mA		
SCWN03C-15		15V	200mA		

DIP24 Package, Regulated 3W, 2:1 V_{in}, Dual V_{out} DCWN03



Model No.	V _{in}	V _{out}	I _{out}	Isolation voltage	Operating temperature
DCWN03E-05	5V (4.5~9V)	±5V	±300mA	3KVDC	-40~+90°C
DCWN03E-12		±12V	±125mA		
DCWN03E-15		±15V	±100mA		
DCWN03A-05		±5V	±300mA		
DCWN03A-12	12V (9~18V)	±12V	±125mA	3KVDC	-40~+90°C
DCWN03A-15		±15V	±100mA		
DCWN03B-05		±5V	±300mA		
DCWN03B-12	24V (18~36V)	±12V	±125mA	3KVDC	-40~+90°C
DCWN03B-15		±15V	±100mA		
DCWN03C-05		±5V	±300mA		
DCWN03C-12	48V (36~72V)	±12V	±125mA	3KVDC	-40~+90°C
DCWN03C-15		±15V	±100mA		

DC/DC Converter 6~8W DIP Regulated Module Type



SCWN06 / DCWN06
(1.25"x 0.8"x 0.4")



SCW08 / DCW08
(1.25"x 0.8"x 0.48")

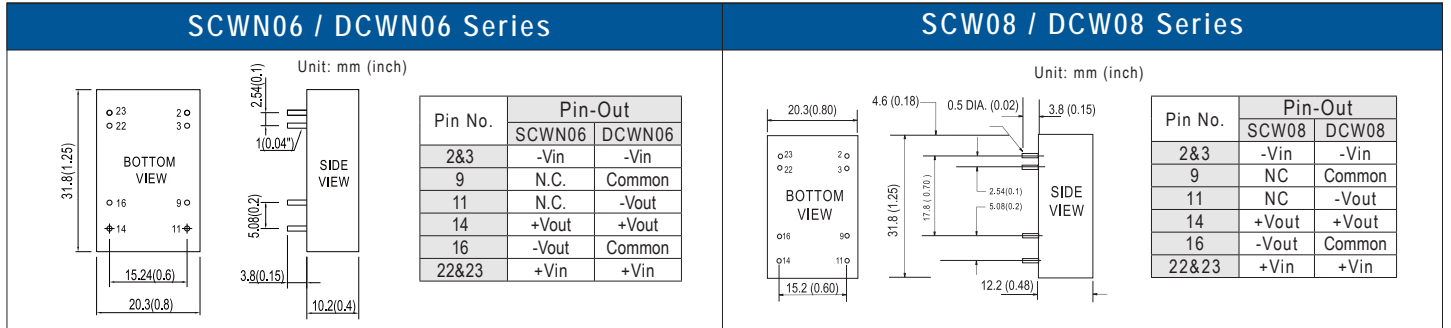

DIP24 Package, Regulated 6W, 2:1 V_{in}, Single V_{out} SCWN06

Model No.	V _{in}	V _{out}	I _{out}	Isolation voltage	Operating temperature
SCWN06A-03	12V (9~18V)	3.3V	1200mA	3KVDC	-40~+90°C
SCWN06A-05		5V	1000mA		
SCWN06A-12		12V	500mA		
SCWN06A-15		15V	400mA		
SCWN06B-03	24V (18~36V)	3.3V	600mA	3KVDC	-40~+90°C
SCWN06B-05		5V	600mA		
SCWN06B-12		12V	250mA		
SCWN06B-15		15V	200mA		
SCWN06C-03	48V (36~72V)	3.3V	1200mA	3KVDC	-40~+90°C
SCWN06C-05		5V	1000mA		
SCWN06C-12		12V	500mA		
SCWN06C-15		15V	400mA		

DIP24 Package, Regulated 6W, 2:1 V_{in}, Dual V_{out} DCWN06

Model No.	V _{in}	V _{out}	I _{out}	Isolation voltage	Operating temperature
DCWN06A-05	12V (9~18V)	±5V	±500mA	3KVDC	-40~+90°C
DCWN06A-12		±12V	±250mA		
DCWN06A-15		±15V	±200mA		
DCWN06B-05	24V (18~36V)	±5V	±500mA	3KVDC	-40~+90°C
DCWN06B-12		±12V	±250mA		
DCWN06B-15		±15V	±200mA		
DCWN06C-05	48V (36~72V)	±5V	±500mA	3KVDC	-40~+90°C
DCWN06C-12		±12V	±250mA		
DCWN06C-15		±15V	±200mA		

DIP24 Package, Regulated 8W, 2:1 V_{in}, Single V_{out} SCW08

Model No.	V _{in}	V _{out}	I _{out}	Isolation voltage	Operating temperature
SCW08A-05	12V (9~18V)	5V	1600mA	1KVDC	-40~+71°C
SCW08A-12		12V	670mA		
SCW08A-15		15V	533mA		
SCW08B-05	24V (18~36V)	5V	1600mA	1KVDC	-40~+71°C
SCW08B-12		12V	670mA		
SCW08B-15		15V	533mA		
SCW08C-05	48V (36~72V)	5V	1600mA	1KVDC	-40~+71°C
SCW08C-12		12V	670mA		
SCW08C-15		15V	533mA		

DIP24 Package, Regulated 8W, 2:1 V_{in}, Dual V_{out} DCW08

Model No.	V _{in}	V _{out}	I _{out}	Isolation voltage	Operating temperature
DCW08A-05	12V (9~18V)	±5V	±800mA	1KVDC	-40~+71°C
DCW08A-12		±12V	±335mA		
DCW08A-15		±15V	±267mA		
DCW08B-05	24V (18~36V)	±5V	±800mA	1KVDC	-40~+71°C
DCW08B-12		±12V	±335mA		
DCW08B-15		±15V	±267mA		
DCW08C-05	48V (36~72V)	±5V	±800mA	1KVDC	-40~+71°C
DCW08C-12		±12V	±335mA		
DCW08C-15		±15V	±267mA		

DC/DC Converter 12~20W DIP Regulated Module Type



SCW12/DCW12
(1.25"x 0.8"x 0.48")



SCW20
(1.25"x 0.8"x 0.48")

SCW12 / DCW12 Series

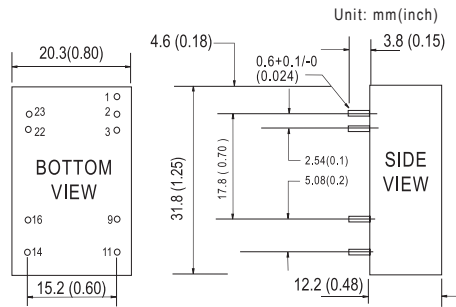

Pin No.	Pin-Out	
	SCW12	DCW12
1	R.C	R.C
2&3	-Vin	-Vin
9	N.C.	Common
11	N.C.	-Vout
14	+Vout	+Vout
16	-Vout	Common
22&23	+Vin	+Vin

SCW20 Series

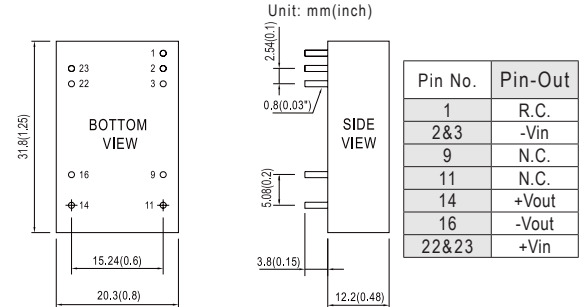

Pin No.	Pin-Out
1	R.C.
2&3	-Vin
9	N.C.
11	N.C.
14	+Vout
16	-Vout
22&23	+Vin

DIP24 Package, Regulated 12W, 2:1 V_{in}, Single V_{out}

SCW12



Model No.	V _{in}	V _{out}	I _{out}	Isolation voltage	Operating temperature
SCW12A-05	12V (9~18V)	5V	2400mA	1.5KVDC	-40~+71°C
SCW12A-12		12V	1000mA		
SCW12A-15		15V	800mA		
SCW12B-05	24V (18~36V)	5V	2400mA	1.5KVDC	-40~+71°C
SCW12B-12		12V	1000mA		
SCW12B-15		15V	800mA		
SCW12C-05	48V (36~72V)	5V	2400mA	1.5KVDC	-40~+71°C
SCW12C-12		12V	1000mA		
SCW12C-15		15V	800mA		

DIP24 Package, Regulated 12W, 2:1 V_{in}, Dual V_{out}

DCW12



Model No.	V _{in}	V _{out}	I _{out}	Isolation voltage	Operating temperature
DCW12A-05	12V (9~18V)	±5V	±1200mA	1.5KVDC	-40~+71°C
DCW12A-12		±12V	±500mA		
DCW12A-15		±15V	±400mA		
DCW12B-05	24V (18~36V)	±5V	±1200mA	1.5KVDC	-40~+71°C
DCW12B-12		±12V	±500mA		
DCW12B-15		±15V	±400mA		
DCW12C-05	48V (36~72V)	±5V	±1200mA	1.5KVDC	-40~+71°C
DCW12C-12		±12V	±500mA		
DCW12C-15		±15V	±400mA		

DIP24 Package, Regulated 20W, 2:1 V_{in}, Single V_{out}

SCW20



Model No.	V _{in}	V _{out}	I _{out}	Isolation voltage	Operating temperature
SCW20A-05	12V (9~18V)	5V	4000mA	1.5KVDC	-40~+80°C
SCW20A-12		12V	1660mA		
SCW20A-15		15V	1333mA		
SCW20B-05	24V (18~36V)	5V	4000mA	1.5KVDC	-40~+80°C
SCW20B-12		12V	1666mA		
SCW20B-15		15V	1333mA		
SCW20C-05	48V (36~75V)	5V	4000mA	1.5KVDC	-40~+80°C
SCW20C-12		12V	1660mA		
SCW20C-15		15V	1333mA		

DC/DC Converter

6~10W 1"x1" Module Type

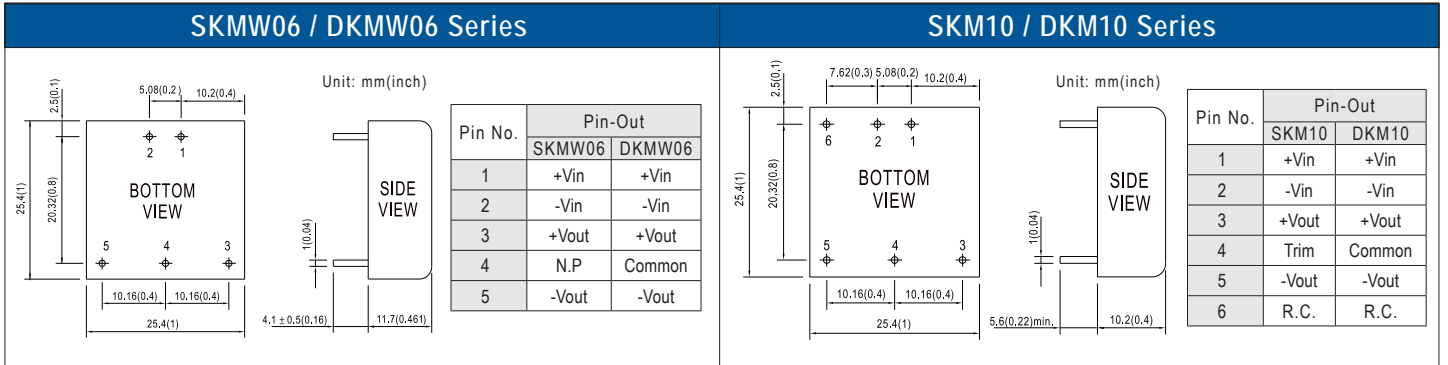

1"x1", Regulated 6W, 4:1 V_{in}, Single V_{out}

SKMW06 **NEW**

Model No.	V _{in}	V _{out}	I _{out}	Isolation voltage	Operating temperature
SKMW06F-03		3.3V	1500mA		
SKMW06F-05		5V	1200mA		
SKMW06F-09	12V, 24V (9~36V)	9V	667mA	1.5KVDC	-40~+85°C
SKMW06F-12		12V	500mA		
SKMW06F-15		15V	400mA		
SKMW06F-24		24V	250mA		
SKMW06G-03		3.3V	1500mA		
SKMW06G-05		5V	1200mA		
SKMW06G-12	24V, 48V (18~75V)	12V	500mA	1.5KVDC	-40~+85°C
SKMW06G-15		15V	400mA		
SKMW06G-24		24V	250mA		

1"x1", Regulated 10W, 2:1 V_{in}, Single V_{out}

SKM10

Model No.	V _{in}	V _{out}	I _{out}	Isolation voltage	Operating temperature
SKM10E-03		3.3V	2500mA		
SKM10E-05	5V (4.7~9V)	5V	2000mA	1.5KVDC	-40~+85°C
SKM10E-12		12V	833mA		
SKM10E-15		15V	666mA		
SKM10A-03		3.3V	2500mA		
SKM10A-05	12V (9~18V)	5V	2000mA	1.5KVDC	-40~+85°C
SKM10A-12		12V	833mA		
SKM10A-15		15V	666mA		
SKM10B-03		3.3V	2500mA		
SKM10B-05	24V (18~36V)	5V	2000mA	1.5KVDC	-40~+85°C
SKM10B-12		12V	833mA		
SKM10B-15		15V	666mA		
SKM10C-03		3.3V	2500mA		
SKM10C-05	48V (36~75V)	5V	2000mA	1.5KVDC	-40~+85°C
SKM10C-12		12V	833mA		
SKM10C-15		15V	666mA		

1"x1", Regulated 6W, 4:1 V_{in}, Dual V_{out}

DKMW06 **NEW**

Model No.	V _{in}	V _{out}	I _{out}	Isolation voltage	Operating temperature
DKMW06F-05		±5V	±600mA		
DKMW06F-12	12V, 24V (9~36V)	±12V	±250mA	1.5KVDC	-40~+85°C
DKMW06F-15		±15V	±200mA		
DKMW06F-24		±24V	±125mA		
DKMW06G-05		±5V	±600mA		
DKMW06G-12	24V, 48V (18~75V)	±12V	±250mA	1.5KVDC	-40~+85°C
DKMW06G-15		±15V	±200mA		

1"x1", Regulated 10W, 2:1 V_{in}, Dual V_{out}

DKM10

Model No.	V _{in}	V _{out}	I _{out}	Isolation voltage	Operating temperature
DKM10E-05		±5V	±1000mA		
DKM10E-12	5V (4.7~9V)	±12V	±416mA	1.5KVDC	-40~+85°C
DKM10E-15		±15V	±333mA		
DKM10A-05		±5V	±1000mA		
DKM10A-12	12V (9~18V)	±12V	±416mA	1.5KVDC	-40~+85°C
DKM10A-15		±15V	±333mA		
DKM10B-05		±5V	±1000mA		
DKM10B-12	24V (18~36V)	±12V	±416mA	1.5KVDC	-40~+85°C
DKM10B-15		±15V	±333mA		
DKM10C-05		±5V	±1000mA		
DKM10C-12	48V (36~75V)	±12V	±416mA	1.5KVDC	-40~+85°C
DKM10C-15		±15V	±333mA		

DC/DC Converter

15~20W 1"x1" Module Type



NEW

SKMW15/DKMW15
(1"x 1"x 0.4")



SKMW20/DKMW20
(1"x 1"x 0.4")

SKMW15/DKMW15

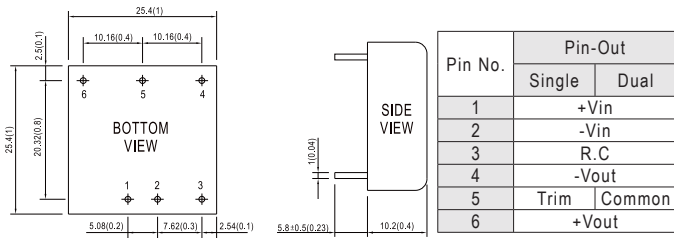

SKMW20/DKMW20

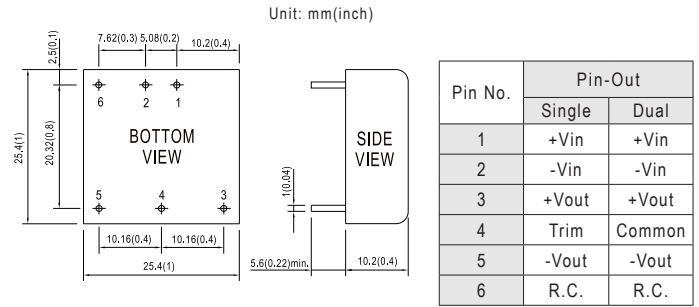

DIP 1"x1" Package, Regulated 15W, 4:1 V_{in} , Single V_{out}

NEW SKMW15



Model No.	V_{in}	V_{out}	I_{out}	Isolation voltage	Operating temperature
SKMW15F-03		3.3V	3000mA		
SKMW15F-05	12V, 24V	5V	3000mA	3KVDC	-40~+85°C
SKMW15F-12	(9~36V)	12V	1250mA		
SKMW15F-15		15V	1000mA		
SKMW15G-03		3.3V	3000mA		
SKMW15G-05	24V, 48V	5V	3000mA	3KVDC	-40~+85°C
SKMW15G-12	(18~75V)	12V	1250mA		
SKMW15G-15		15V	1000mA		

DIP 1"x1" Package, Regulated 15W, 4:1 V_{in} , Dual V_{out}

NEW DKMW15



Model No.	V_{in}	V_{out}	I_{out}	Isolation voltage	Operating temperature
DKMW15F-05		±5V	±1500mA		
DKMW15F-12	12V, 24V	±12V	±625mA	3KVDC	-40~+85°C
DKMW15F-15	(9~36V)	±15V	±500mA		
DKMW15G-05		±5V	±1500mA		
DKMW15G-12	24V, 48V	±12V	±625mA	3KVDC	-40~+85°C
DKMW15G-12	(18~75V)	±12V	±625mA		
DKMW15G-15		±15V	±500mA		

DIP 1"x1" Package, Regulated 20W, 4:1 V_{in} , Single V_{out}

SKMW20



Model No.	V_{in}	V_{out}	I_{out}	Isolation voltage	Operating temperature
SKMW20F-03		3.3V	4500mA		
SKMW20F-05	12V, 24V	5V	4000mA	1.5KVDC	-40~+85°C
SKMW20F-12	(9~36V)	12V	1670mA		
SKMW20F-15		15V	1330mA		
SKMW20G-03		3.3V	4500mA		
SKMW20G-05	24V, 48V	5V	4000mA	1.5KVDC	-40~+85°C
SKMW20G-12	(18~75V)	12V	1670mA		
SKMW20G-15		15V	1330mA		

DIP 1"x1" Package, Regulated 20W, 4:1 V_{in} , Dual V_{out}

DKMW20



Model No.	V_{in}	V_{out}	I_{out}	Isolation voltage	Operating temperature
DKMW20F-12	12V, 24V	±12V	±830mA	1.5KVDC	-40~+85°C
DKMW20F-15	(9~36V)	±15V	±660mA		
DKMW20G-12	24V, 48V	±12V	±830mA		
DKMW20G-15	(18~75V)	±15V	±660mA	1.5KVDC	-40~+85°C



SKMW30/DKMW30
(1"x 1"x 0.4")

SKMW30 & DKMW30 Series

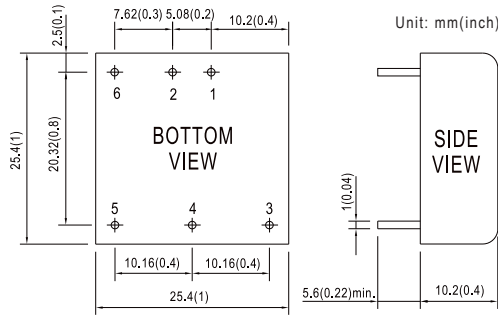

Pin No.	Pin-Out	
	Single	Dual
1	+Vin	+Vin
2	-Vin	-Vin
3	+Vout	+Vout
4	Trim	Common
5	-Vout	-Vout
6	R.C.	R.C.

DIP 1"x1" Package, Regulated 30W, 4:1 V_{in} , Single V_{out} SKMW30

Model No.	V_{in}	V_{out}	I_{out}	Isolation voltage	Operating temperature
SKMW30F-03		3.3V	7500mA		
SKMW30F-05	12V, 24V (9~36V)	5V	6000mA	1.5KVDC	-40~+85°C
SKMW30F-12		12V	2500mA		
SKMW30F-15		15V	2000mA		
SKMW30G-03		3.3V	7500mA		
SKMW30G-05	24V, 48V (18~75V)	5V	6000mA	1.5KVDC	-40~+85°C
SKMW30G-12		12V	2500mA		
SKMW30G-15		15V	2000mA		

DIP 1"x1" Package, Regulated 30W, 4:1 V_{in} , Dual V_{out} DKMW30

Model No.	V_{in}	V_{out}	I_{out}	Isolation voltage	Operating temperature
DKMW30F-12	12V, 24V (9~36V)	$\pm 12V$	$\pm 1250mA$	1.5KVDC	-40~+85°C
DKMW30F-15		$\pm 15V$	$\pm 1000mA$		
DKMW30G-12	24V, 48V (18~75V)	$\pm 12V$	$\pm 1250mA$	1.5KVDC	-40~+85°C
DKMW30G-15		$\pm 15V$	$\pm 1000mA$		

DC/DC Converter

5~10W 2"x1" Module Type



SLW05/DLW05
(2"x 1"x 0.44")



SKE10/DKE10
(2"x 1"x 0.44")

SLW05 / DLW05 Series

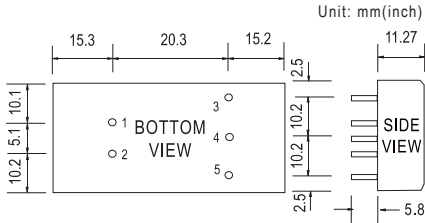

Pin No.	Pin-Out	
	SLW05	DLW05
1	+Vin	+Vin
2	-Vin	-Vin
3	+Vout	+Vout
4	No Pin	Common
5	-Vout	-Vout

SKE10 / DKE10 Series

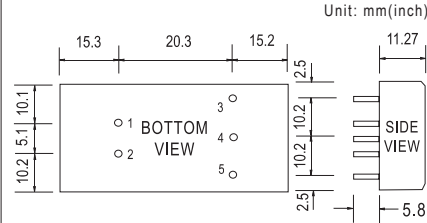

Pin No.	Pin-Out	
	SKE10	DKE10
1	+Vin	+Vin
2	-Vin	-Vin
3	+Vout	+Vout
4	No Pin	Common
5	-Vout	-Vout

2"x1", Regulated 5W, 2:1 Vin, Single Vout SLW05 EMI FC UK CE

Model No.	V _{in}	V _{out}	I _{out}	Isolation voltage	Operating temperature
SLW05A-05	12V (9~18V)	5V	1000mA	1KVDC	-25~+71°C
SLW05A-09		9V	556mA		
SLW05A-12		12V	417mA		
SLW05A-15		15V	333mA		
SLW05B-05	24V (18~36V)	5V	1000mA	1KVDC	-25~+71°C
SLW05B-09		9V	556mA		
SLW05B-12		12V	417mA		
SLW05B-15		15V	333mA		
SLW05C-05	48V (36~72V)	5V	1000mA	1KVDC	-25~+71°C
SLW05C-09		9V	556mA		
SLW05C-12		12V	417mA		
SLW05C-15		15V	333mA		

2"x1", Regulated 10W, 2:1 Vin, Single Vout SKE10 EMI FC UK CE

Model No.	V _{in}	V _{out}	I _{out}	Isolation voltage	Operating temperature
SKE10A-05	12V (9~18V)	5V	2000mA	1KVDC	-25~+71°C
SKE10A-12		12V	840mA		
SKE10A-15		15V	660mA		
SKE10A-24		24V	420mA		
SKE10B-05	24V (18~36V)	5V	2000mA	1KVDC	-25~+71°C
SKE10B-12		12V	840mA		
SKE10B-15		15V	660mA		
SKE10B-24		24V	420mA		
SKE10C-05	48V (36~72V)	5V	2000mA	1KVDC	-25~+71°C
SKE10C-12		12V	840mA		
SKE10C-15		15V	660mA		
SKE10C-24		24V	420mA		

2"x1", Regulated 5W, 2:1 Vin, Dual Vout DLW05 EMI FC UK CE

Model No.	V _{in}	V _{out}	I _{out}	Isolation voltage	Operating temperature
DLW05A-05	12V (9~18V)	±5V	±500mA	1KVDC	-25~+71°C
DLW05A-12		±12V	±208mA		
DLW05A-15		±15V	±167mA		
DLW05B-05	24V (18~36V)	±5V	±500mA	1KVDC	-25~+71°C
DLW05B-12		±12V	±208mA		
DLW05B-15		±15V	±167mA		
DLW05C-05	48V (36~72V)	±5V	±500mA	1KVDC	-25~+71°C
DLW05C-12		±12V	±208mA		
DLW05C-15		±15V	±167mA		

2"x1", Regulated 10W, 2:1 Vin, Dual Vout DKE10 EMI FC UK CE

Model No.	V _{in}	V _{out}	I _{out}	Isolation voltage	Operating temperature
DKE10A-05	12V (9~18V)	±5V	±1000mA	1KVDC	-25~+71°C
DKE10A-12		±12V	±420mA		
DKE10A-15		±15V	±333mA		
DKE10A-24		±24V	±210mA		
DKE10B-05	24V (18~36V)	±5V	±1000mA	1KVDC	-25~+71°C
DKE10B-12		±12V	±420mA		
DKE10B-15		±15V	±333mA		
DKE10B-24		±24V	±210mA		
DKE10C-05	48V (36~72V)	±5V	±1000mA	1KVDC	-25~+71°C
DKE10C-12		±12V	±420mA		
DKE10C-15		±15V	±333mA		
DKE10C-24		±24V	±210mA		

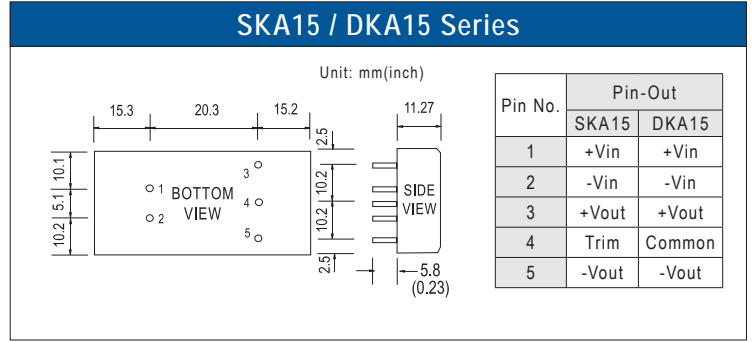

2"x1" Package, Regulated 15W, 2:1 V_{in} , Single V_{out} SKA15 ERI FC UK CA CE

Model No.	V_{in}	V_{out}	I_{out}	Isolation voltage	Operating temperature
SKA15A-033		3.3V	3000mA		
SKA15A-05	12V (9~18V)	5V	3000mA	1KVDC	-40~+71°C
SKA15A-12		12V	1250mA		
SKA15A-15		15V	1000mA		
SKA15B-033		3.3V	3000mA		
SKA15B-05	24V (18~36V)	5V	3000mA	1KVDC	-40~+71°C
SKA15B-12		12V	1250mA		
SKA15B-15		15V	1000mA		
SKA15C-033		3.3V	3000mA		
SKA15C-05	48V (36~72V)	5V	3000mA	1KVDC	-40~+71°C
SKA15C-12		12V	1250mA		
SKA15C-15		15V	1000mA		

2"x1" Package, Regulated 15W, 2:1 V_{in} , Dual V_{out} DKA15 ERI FC UK CA CE

Model No.	V_{in}	V_{out}	I_{out}	Isolation voltage	Operating temperature
DKA15A-05		±5V	±1500mA		
DKA15A-12	12V (9~18V)	±12V	±625mA	1KVDC	-40~+71°C
DKA15A-15		±15V	±500mA		
DKA15B-05		±5V	±1500mA		
DKA15B-12	24V (18~36V)	±12V	±625mA	1KVDC	-40~+71°C
DKA15B-15		±15V	±500mA		
DKA15C-05		±5V	±1500mA		
DKA15C-12	48V (36~72V)	±12V	±625mA	1KVDC	-40~+71°C
DKA15C-15		±15V	±500mA		



SKA20
(2"x 1"x 0.44")



SKM30
(2"x 1"x 0.44")



SKM50
(2"x 1"x 0.54")

SKA20 Series

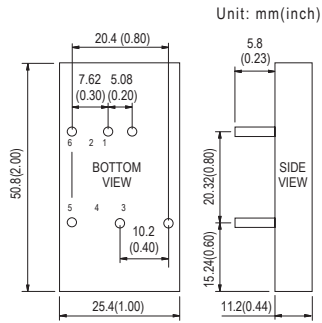

Pin No.	Output
1	+Vin
2	-Vin
3	+Vout
4	Trim
5	-Vout
6	R.C.

SKM30 / SKM50 Series

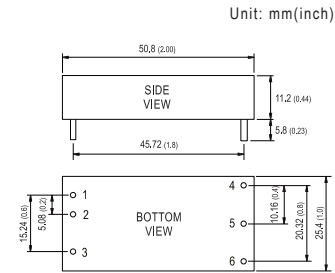

Pin No.	Output
1	+Vin
2	-Vin
3	R.C.
4	+Vout
5	-Vout
6	Trim

2"x1" Package, Regulated 20W, 2:1 V_{in} , Single V_{out}

SKA20

Model No.	V_{in}	V_{out}	I_{out}	Isolation voltage	Operating temperature
SKA20A-05	12V	5V	4000mA	1.5KVDC	-40~+85°C
SKA20A-12	(9~18V)	12V	1666mA		
SKA20A-15		15V	1333mA		
SKA20B-05	24V	5V	4000mA	1.5KVDC	-40~+85°C
SKA20B-12	(18~36V)	12V	1666mA		
SKA20B-15		15V	1333mA		
SKA20C-05	48V	5V	4000mA	1.5KVDC	-40~+85°C
SKA20C-12	(36~75V)	12V	1666mA		
SKA20C-15		15V	1333mA		

2"x1" Package, Regulated 30W, 2:1 V_{in} , Single V_{out}

SKM30

Model No.	V_{in}	V_{out}	I_{out}	Isolation voltage	Operating temperature
SKM30A-05	12V	5V	6000mA	1.5KVDC	-40~+75°C
SKM30A-12	(9~18V)	12V	2500mA		
SKM30A-15		15V	2000mA		
SKM30B-05	24V	5V	6000mA	1.5KVDC	-40~+75°C
SKM30B-12	(18~36V)	12V	2500mA		
SKM30B-15		15V	2000mA		
SKM30C-05	48V	5V	6000mA	1.5KVDC	-40~+75°C
SKM30C-12	(36~75V)	12V	2500mA		
SKM30C-15		15V	2000mA		

2"x1" Package, Regulated 50W, 2:1 V_{in} , Single V_{out}

SKM50

Model No.	V_{in}	V_{out}	I_{out}	Isolation voltage	Operating temperature
SKM50B-05	24V	5V	10A	1.5KVDC	-40~+75°C
SKM50B-12	(18~36V)	12V	4170mA		
SKM50B-15		15V	3330mA		
SKM50C-05	48V	5V	10A	1.5KVDC	-40~+75°C
SKM50C-12	(36~75V)	12V	4170mA		
SKM50C-15		15V	3330mA		



SKE15
(2"x 2"x 0.43")



DKE15
(2"x 2"x 0.43")

SKE15 Series

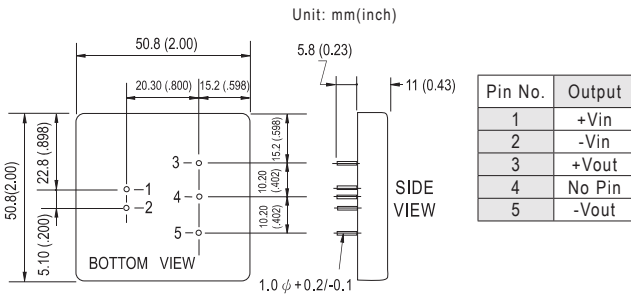

DKE15 Series

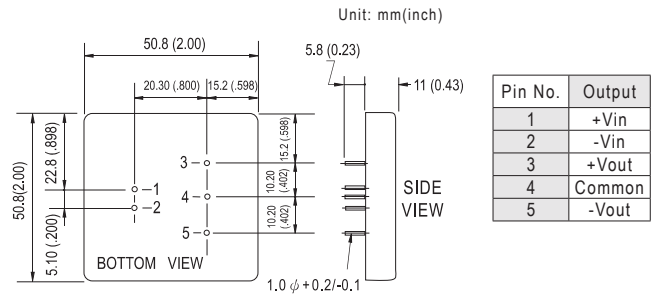

2"x 2" Package, Regulated 15W, 2:1 V_{in}, Single V_{out}

SKE15 EMI FC UK CE

Model No.	V _{in}	V _{out}	I _{out}	Isolation voltage	Operating temperature
SKE15A-05		5V	3000mA		
SKE15A-12	12V	12V	1250mA	1KVDC	-25~+71°C
SKE15A-15	(9~18V)	15V	1000mA		
SKE15A-24		24V	625mA		
SKE15B-05		5V	3000mA		
SKE15B-12	24V	12V	1250mA	1KVDC	-25~+71°C
SKE15B-15	(18~36V)	15V	1000mA		
SKE15B-24		24V	625mA		
SKE15C-05		5V	3000mA		
SKE15C-12	48V	12V	1250mA	1KVDC	-25~+71°C
SKE15C-15	(36~72V)	15V	1000mA		
SKE15C-24		24V	625mA		

2"x 2" Package, Regulated 15W, 2:1 V_{in}, Dual V_{out}

DKE15 EMI FC UK CE

Model No.	V _{in}	V _{out}	I _{out}	Isolation voltage	Operating temperature
DKE15A-05		±5V	±1500mA		
DKE15A-12	12V	±12V	±625mA	1KVDC	-25~+71°C
DKE15A-15	(9~18V)	±15V	±500mA		
DKE15A-24		±24V	±313mA		
DKE15B-05		±5V	±1500mA		
DKE15B-12	24V	±12V	±625mA	1KVDC	-25~+71°C
DKE15B-15	(18~36V)	±15V	±500mA		
DKE15B-24		±24V	±313mA		
DKE15C-05		±5V	±1500mA		
DKE15C-12	48V	±12V	±625mA	1KVDC	-25~+71°C
DKE15C-15	(36~72V)	±15V	±500mA		
DKE15C-24		±24V	±313mA		



SDM30
(2"x 2" x 0.63")

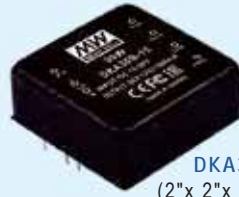

DKA30
(2"x 2" x 0.82")



TKA30
(2"x 2" x 0.82")

SDM30 Series

DKA30 / TKA30 Series

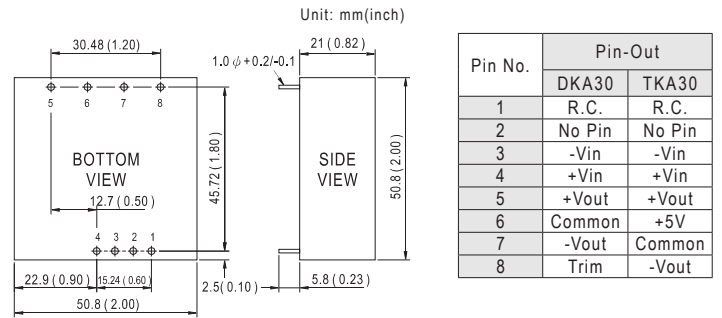
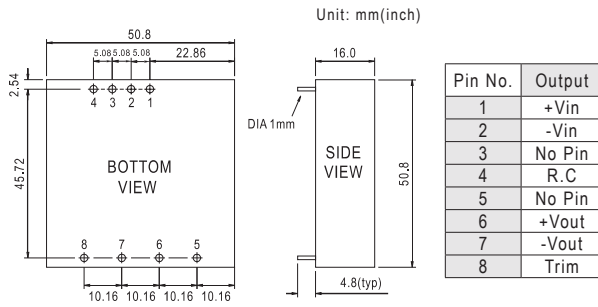

2"x 2" Package, Regulated 30W, 2:1 V_{in} , Single V_{out} SDM30

Model No.	V_{in}	V_{out}	I_{out}	Isolation voltage	Operating temperature
SDM30-12S3	12V (9.2~18V)	3.3V	5000mA	1KVDC	-25~+85°C
SDM30-12S5		5V	5000mA		
SDM30-12S12		12V	2100mA		
SDM30-12S15		15V	1700mA		
SDM30-24S3	24V (18~36V)	3.3V	5000mA	1KVDC	-25~+85°C
SDM30-24S5		5V	5000mA		
SDM30-24S12		12V	2100mA		
SDM30-24S15		15V	1700mA		
SDM30-48S3	48V (36~72V)	3.3V	5000mA	1KVDC	-25~+85°C
SDM30-48S5		5V	5000mA		
SDM30-48S12		12V	2100mA		
SDM30-48S15		15V	1700mA		

2"x 2" Package, Regulated 30W, 2:1 V_{in} , Dual V_{out} DKA30

Model No.	V_{in}	V_{out}	I_{out}	Isolation voltage	Operating temperature
DKA30A-05	12V (9~18V)	±5V	±2500mA	1KVDC	-40~+85°C
DKA30A-12		±12V	±1250mA		
DKA30A-15		±15V	±1000mA		
DKA30B-05	24V (18~36V)	±5V	±2500mA	1KVDC	-40~+85°C
DKA30B-12		±12V	±1250mA		
DKA30B-15		±15V	±1000mA		
DKA30C-05	48V (36~72V)	±5V	±2500mA	1KVDC	-40~+85°C
DKA30C-12		±12V	±1250mA		
DKA30C-15		±15V	±1000mA		

2"x 2" Package, Regulated 30W, 2:1 V_{in} , Triple V_{out} TKA30

Model No.	V_{in}	V_{out}	I_{out}	Isolation voltage	Operating temperature
TKA30A-B	12V (9~18V)	5V / ±12V	3500mA / ±310mA	1KVDC	-40~+85°C
TKA30A-C		5V / ±15V	3500mA / ±250mA		
TKA30B-B	24V (18~36V)	5V / ±12V	3500mA / ±310mA	1KVDC	-40~+85°C
TKA30B-C		5V / ±15V	3500mA / ±250mA		
TKA30C-B	48V (36~72V)	5V / ±12V	3500mA / ±310mA	1KVDC	-40~+85°C
TKA30C-C		5V / ±15V	3500mA / ±250mA		



SKA40
(2"x2"x0.43")



SKA60
(2"x2"x0.43")

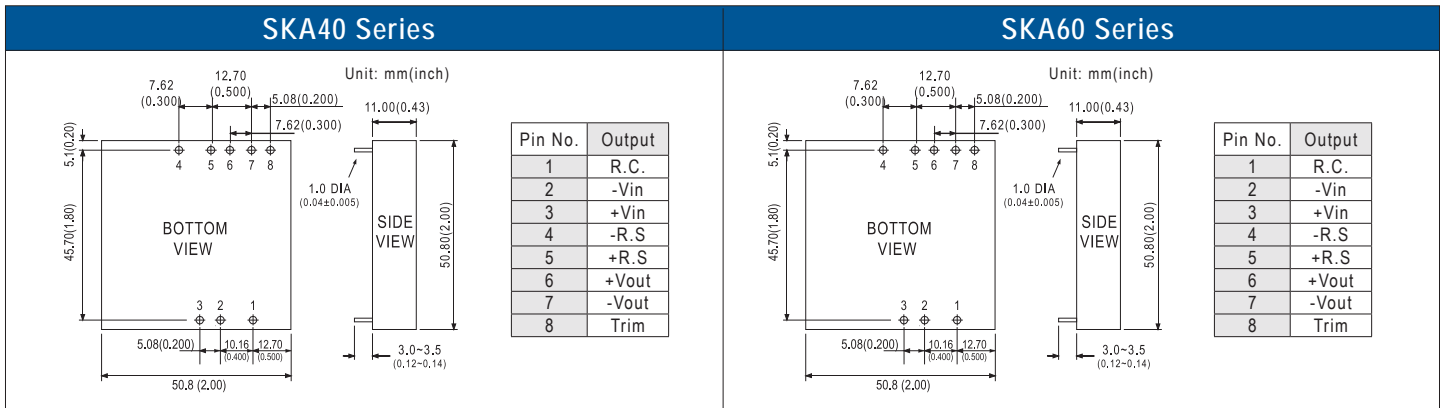

2"x 2" Package, Regulated 40W, 2:1 V_{in}, Single V_{out} SKA40 EMI FC UK CE

Model No.	V _{in}	V _{out}	I _{out}	Isolation voltage	Operating temperature
SKA40A-05		5V	7A		
SKA40A-12	12V (9~18V)	12V	3330mA	1.5KVDC	-40~+80°C
SKA40A-15		15V	2670mA		
SKA40B-05		5V	7A		
SKA40B-12	24V (18~36V)	12V	3330mA	1.5KVDC	-40~+80°C
SKA40B-15		15V	2670mA		
SKA40C-05		5V	7A		
SKA40C-12	48V (36~75V)	12V	3330mA	1.5KVDC	-40~+80°C
SKA40C-15		15V	2670mA		

2"x 2" Package, Regulated 60W, 2:1 V_{in}, Single V_{out} SKA60 EMI FC UK CE

Model No.	V _{in}	V _{out}	I _{out}	Isolation voltage	Operating temperature
SKA60A-05		5V	12A		
SKA60A-12	12V (9~18V)	12V	5A	1.5KVDC	-40~+70°C
SKA60A-15		15V	4A		
SKA60B-05		5V	12A		
SKA60B-12	24V (18~36V)	12V	5A	1.5KVDC	-40~+70°C
SKA60B-15		15V	4A		
SKA60C-05		5V	12A		
SKA60C-12	48V (36~75V)	12V	5A	1.5KVDC	-40~+70°C
SKA60C-15		15V	4A		



MHB75
(2.28"x2.4"x0.5")



MHB100
(2.28"x2.4"x0.5")



MHB150
(2.28"x2.4"x0.5")

MHB75 / MHB100 / MHB150 Series

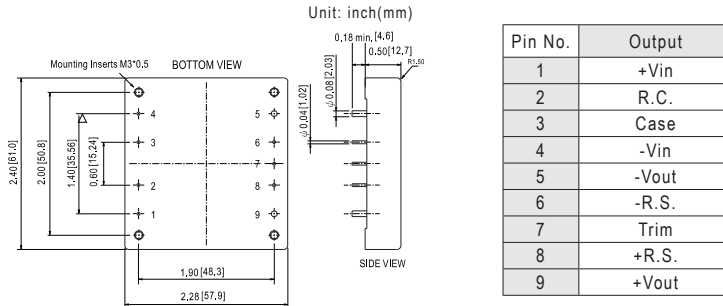

Half-brick, Regulated 75W, 2:1 V_{in} , Single V_{out}

MHB75

Model No.	V_{in}	V_{out}	I_{out}	Isolation voltage	Operating temperature
MHB75-12S05	12V (9~18V)	5V	15A	1.5KVDC	-40~+100°C
MHB75-12S12		12V	6.25A		
MHB75-12S24		24V	3.13A		
MHB75-24S05	24V (18~36V)	5V	15A	1.5KVDC	-40~+100°C
MHB75-24S12		12V	6.25A		
MHB75-24S24		24V	3.13A		
MHB75-48S05	48V (36~75V)	5V	15A	1.5KVDC	-40~+100°C
MHB75-48S12		12V	6.25A		
MHB75-48S24		24V	3.13A		

Half-brick, Regulated 100W, 2:1 V_{in} / Single V_{out}

MHB100

Model No.	V_{in}	V_{out}	I_{out}	Isolation voltage	Operating temperature
MHB100-24S05	24V (18~36V)	5V	20A	1.5KVDC	-40~+100°C
MHB100-24S12		12V	8.3A		
MHB100-24S24		24V	4.17A		
MHB100-48S05	48V (36~75V)	5V	20A	1.5KVDC	-40~+100°C
MHB100-48S12		12V	8.3A		
MHB100-48S24		24V	4.17A		

Half-brick, Regulated 150W, 2:1 V_{in} , Single V_{out}

MHB150

Model No.	V_{in}	V_{out}	I_{out}	Isolation voltage	Operating temperature
MHB150-48S05	48V (36~75V)	5V	30A	1.5KVDC	-40~+100°C
MHB150-48S12		12V	12.5A		
MHB150-48S24		24V	6.25A		

Heat Sink for MHB Series

Order No.	M-C308 (Vertical Fins)	M-C091 (Horizontal Fins)	M-C092 (Horizontal Fins)
Mechanical			

Note: Power module and heat sink should be ordered separately. The heat sinks can be used with MHB75/100/150 series.

DC/DC Converter 5~15W Isolated On Board Type



NSD05-S
(1.6"x1"x0.327")



NSD10-S/D
(2"x1"x0.394")



NSD15-S/D
(2"x1.5"x0.387")

NSD05-S Series

Unit: mm(inch)

Pin No.	Output
1	+Vin
2	-Vin
3	+Vout
4	-Vout
5	R.C.

NSD10-S/D Series

Unit: mm(inch)

Pin No.	Output	
	NSD10-S	NSD10-D
1	+Vin	+Vin
2	-Vin	-Vin
3	+Vout	-Vout
4	N.C.	Common
5	-Vout	-Vout
6	R.C.	R.C.

NSD15-S/D Series

Unit: mm(inch)

Pin No.	Output	
	NSD15-S	NSD15-D
1	+Vin	+Vin
2	-Vin	-Vin
3	No Pin	No Pin
4	Control	Control
5	No Pin	+Vout
6	+Vout	Common
7	-Vout	-Vout
8	Trim	Trim

5W, Isolated, Single V_{out} NSD05

Model No.	V _{in}	V _{out}	I _{out}	Isolation voltage	Operating temp.
NSD05-12S3		3.3V	1200mA		
NSD05-12S5	12V, 24V (9.2~36V)	5V	1000mA	1KVDC	-25~+70°C
NSD05-12S12		12V	420mA		
NSD05-12S15		15V	330mA		
NSD05-48S3		3.3V	1200mA		
NSD05-48S5	24V, 48V (18~72V)	5V	1000mA	1KVDC	-25~+70°C
NSD05-48S12		12V	420mA		
NSD05-48S15		15V	330mA		

10W, Isolated, Single V_{out} NSD10-S

Model No.	V _{in}	V _{out}	I _{out}	Isolation voltage	Operating temp.
NSD10-12S3		3.3V	2500mA		
NSD10-12S5	12V, 24V (9.8~36V)	5V	2000mA	1KVDC	-25~+70°C
NSD10-12S9		9V	1100mA		
NSD10-12S12		12V	830mA		
NSD10-12S15		15V	670mA		
NSD10-48S3		3.3V	2500mA		
NSD10-48S5	24V, 48V (22~72V)	5V	2000mA	1KVDC	-25~+70°C
NSD10-48S9		9V	1100mA		
NSD10-48S12		12V	830mA		
NSD10-48S15		15V	670mA		

10W, Isolated, Dual V_{out} NSD10-D

Model No.	V _{in}	V _{out}	I _{out}	Isolation voltage	Operating temp.
NSD10-12D5	12V, 24V (9.8~36V)	±5V	±1000mA	1KVDC	-25~+70°C
NSD10-12D12		±12V	±420mA		
NSD10-12D15		±15V	±330mA		
NSD10-48D5	24V, 48V (22~72V)	±5V	±1000mA	1KVDC	-25~+70°C
NSD10-48D12		±12V	±420mA		
NSD10-48D15		±15V	±330mA		

15W, Isolated, Single V_{out} NSD15-S

Model No.	V _{in}	V _{out}	I _{out}	Isolation voltage	Operating temp.
NSD15-12S3		3.3V	3750mA		
NSD15-12S5	12V (9.4~36V)	5V	3000mA	1.5KVDC	-25~+70°C
NSD15-12S12		12V	1250mA		
NSD15-12S15		15V	1000mA		
NSD15-48S3		3.3V	3750mA		
NSD15-48S5	48V (18~72V)	5V	3000mA	1.5KVDC	-25~+70°C
NSD15-48S12		12V	1250mA		
NSD15-48S15		15V	1000mA		

15W, Isolated, Dual V_{out} NSD15-D

Model No.	V _{in}	V _{out}	I _{out}	Isolation voltage	Operating temp.
NSD15-12D5		±5V	±1500mA		
NSD15-12D12	12V (9.4~36V)	±12V	±620mA	1.5KVDC	-25~+70°C
NSD15-12D15		±15V	±500mA		
NSD15-48D5		±5V	±1500mA		
NSD15-48D12	48V (18~72V)	±12V	±620mA	1.5KVDC	-25~+70°C
NSD15-48D15		±15V	±500mA		

DC/DC Converter 35~100W Non-Isolated Low Cost On Board Type



NID35
(2"x0.512"x0.433")



NID65
(2"x1.024"x0.433")



NID100
(2"x1.082"x0.427")

NID35 Series	NID65 Series	NID100 Series																																										
<p>Unit: mm(inch)</p> <p>50.8 [2] 4.5 [0.18] 11 [0.433] max. 8 [0.315] 13 [0.512] 4 [0.16] 1 2 3 4 5 6 7 8 9 10 11 0.64 [0.025] 10.2 [0.402] 25.4 [1] 1.3 [0.051] 2.54 [0.1]</p> <table border="1"> <thead> <tr> <th>Pin No.</th> <th>Output</th> </tr> </thead> <tbody> <tr> <td>1,2,3,4</td> <td>+Vout</td> </tr> <tr> <td>5,6</td> <td>Common</td> </tr> <tr> <td>7,8</td> <td>+Vin</td> </tr> <tr> <td>9</td> <td>N.C.</td> </tr> <tr> <td>10</td> <td>Trim (optional)</td> </tr> <tr> <td>11</td> <td>R.C.</td> </tr> </tbody> </table>	Pin No.	Output	1,2,3,4	+Vout	5,6	Common	7,8	+Vin	9	N.C.	10	Trim (optional)	11	R.C.	<p>Unit: mm(inch)</p> <p>50.8 [2] 4.5 [0.18] 11 [0.433] max. 9 [0.315] 28 [1.024] 4 [0.16] 1 2 3 4 5 6 7 8 9 10 11 0.64 [0.025] 10.2 [0.402] 25.4 [1] 1.3 [0.051] 2.54 [0.1]</p> <table border="1"> <thead> <tr> <th>Pin No.</th> <th>Output</th> </tr> </thead> <tbody> <tr> <td>1,2,3,4</td> <td>+Vout</td> </tr> <tr> <td>5,6</td> <td>Common</td> </tr> <tr> <td>7,8</td> <td>+Vin</td> </tr> <tr> <td>9</td> <td>N.C.</td> </tr> <tr> <td>10</td> <td>Trim (optional)</td> </tr> <tr> <td>11</td> <td>R.C.</td> </tr> </tbody> </table>	Pin No.	Output	1,2,3,4	+Vout	5,6	Common	7,8	+Vin	9	N.C.	10	Trim (optional)	11	R.C.	<p>Unit: mm(inch)</p> <p>50.8 [2] 4.5 [0.18] 12 [0.472] max. 9 [0.315] 27.5 [1.082] 4 [0.16] 1 2 3 4 5 6 7 8 9 10 11 12 13 0.64 [0.025] 10.2 [0.402] 25.4 [1] 1.3 [0.051] 2.54 [0.1]</p> <table border="1"> <thead> <tr> <th>Pin No.</th> <th>Output</th> </tr> </thead> <tbody> <tr> <td>1,2,3,4</td> <td>+Vout</td> </tr> <tr> <td>5,6,7,8</td> <td>Common</td> </tr> <tr> <td>9,10</td> <td>+Vin</td> </tr> <tr> <td>11</td> <td>N.C.</td> </tr> <tr> <td>12</td> <td>Trim (optional)</td> </tr> <tr> <td>13</td> <td>R.C.</td> </tr> </tbody> </table>	Pin No.	Output	1,2,3,4	+Vout	5,6,7,8	Common	9,10	+Vin	11	N.C.	12	Trim (optional)	13	R.C.
Pin No.	Output																																											
1,2,3,4	+Vout																																											
5,6	Common																																											
7,8	+Vin																																											
9	N.C.																																											
10	Trim (optional)																																											
11	R.C.																																											
Pin No.	Output																																											
1,2,3,4	+Vout																																											
5,6	Common																																											
7,8	+Vin																																											
9	N.C.																																											
10	Trim (optional)																																											
11	R.C.																																											
Pin No.	Output																																											
1,2,3,4	+Vout																																											
5,6,7,8	Common																																											
9,10	+Vin																																											
11	N.C.																																											
12	Trim (optional)																																											
13	R.C.																																											

35W, Non-isolated

NID35 EAC UK CA CE

Model No.	V _{in}	V _{out}	I _{out}	Operating temperature
NID35-05	12V, 24V, 48V (10.5~53V)	5V	3.5A	-30~+85°C
NID35-12	24V, 48V (20~53V)	12V	2.9A	
NID35-15	24V, 48V (20~53V)	15V	2.4A	
NID35-24	48V (30~53V)	24V	1.5A	

65W, Non-isolated

NID65 EAC UK CA CE

Model No.	V _{in}	V _{out}	I _{out}	Operating temperature
NID65-05	12V, 24V, 48V (10.5~53V)	5V	6.5A	-30~+85°C
NID65-12	24V, 48V (20~53V)	12V	4.9A	
NID65-15	24V, 48V (20~53V)	15V	4.3A	
NID65-24	48V (30~53V)	24V	2.7A	

100W, Non-isolated

NID100 EAC UK CA CE

Model No.	V _{in}	V _{out}	I _{out}	Operating temperature
NID100-05	12V, 24V, 48V (10.5~53V)	5V	11A	-30~+85°C
NID100-12	24V, 48V (20~53V)	12V	7.5A	
NID100-15	24V, 48V (20~53V)	15V	6.5A	
NID100-24	48V (30~53V)	24V	4.2A	

DC/DC Converter 15~45W Single Output Open Frame Type



PSD-15
(94x 49x 25mm)

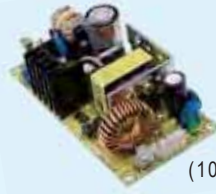

PSD-30
(101.6x 50.8x 30mm)



PSD-45
(127x 76x 30mm)

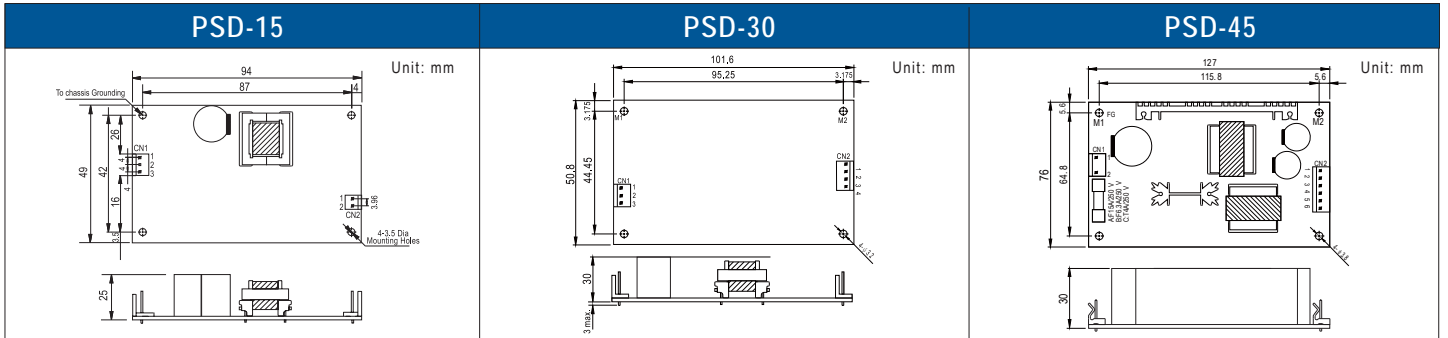

15W, Isolated, Regulated

PSD-15

Model No.	V_{in}	V_{out}	I_{out}	Isolation voltage	Operating temperature
PSD-15A-05	12V (9.2~18V)	5V	3A	1.5KVAC	-10~+60°C
PSD-15A-12		12V	1.25A		
PSD-15A-24		24V	0.6A		
PSD-15B-05	24V (18~36V)	5V	3A	1.5KVAC	-10~+60°C
PSD-15B-12		12V	1.25A		
PSD-15B-24		24V	0.6A		
PSD-15C-05	48V (36~72V)	5V	3A	1.5KVAC	-10~+60°C
PSD-15C-12		12V	1.25A		
PSD-15C-24		24V	0.6A		

30W, Isolated, Regulated

PSD-30

Model No.	V_{in}	V_{out}	I_{out}	Isolation voltage	Operating temperature
PSD-30A-05	12V (9~18V)	5V	5A	1.5KVAC	-20~+60°C
PSD-30A-12		12V	2.5A		
PSD-30A-24		24V	1.25A		
PSD-30B-05	24V (18~36V)	5V	5A	1.5KVAC	-20~+60°C
PSD-30B-12		12V	2.5A		
PSD-30B-24		24V	1.25A		
PSD-30C-05	48V (36~72V)	5V	5A	1.5KVAC	-20~+60°C
PSD-30C-12		12V	2.5A		
PSD-30C-24		24V	1.25A		

45W, Isolated, Regulated

PSD-45

Model No.	V_{in}	V_{out}	I_{out}	Isolation voltage	Operating temperature
PSD-45A-05	12V (9.2~18V)	5V	6A	1.5KVAC	-10~+60°C
PSD-45A-12		12V	2.5A		
PSD-45A-24		24V	1.25A		
PSD-45B-05	24V (18~36V)	5V	9A	1.5KVAC	-10~+60°C
PSD-45B-12		12V	3.75A		
PSD-45B-24		24V	1.875A		
PSD-45C-05	48V (36~72V)	5V	9A	1.5KVAC	-10~+60°C
PSD-45C-12		12V	3.75A		
PSD-45C-24		24V	1.875A		

DIN Rail Accessories

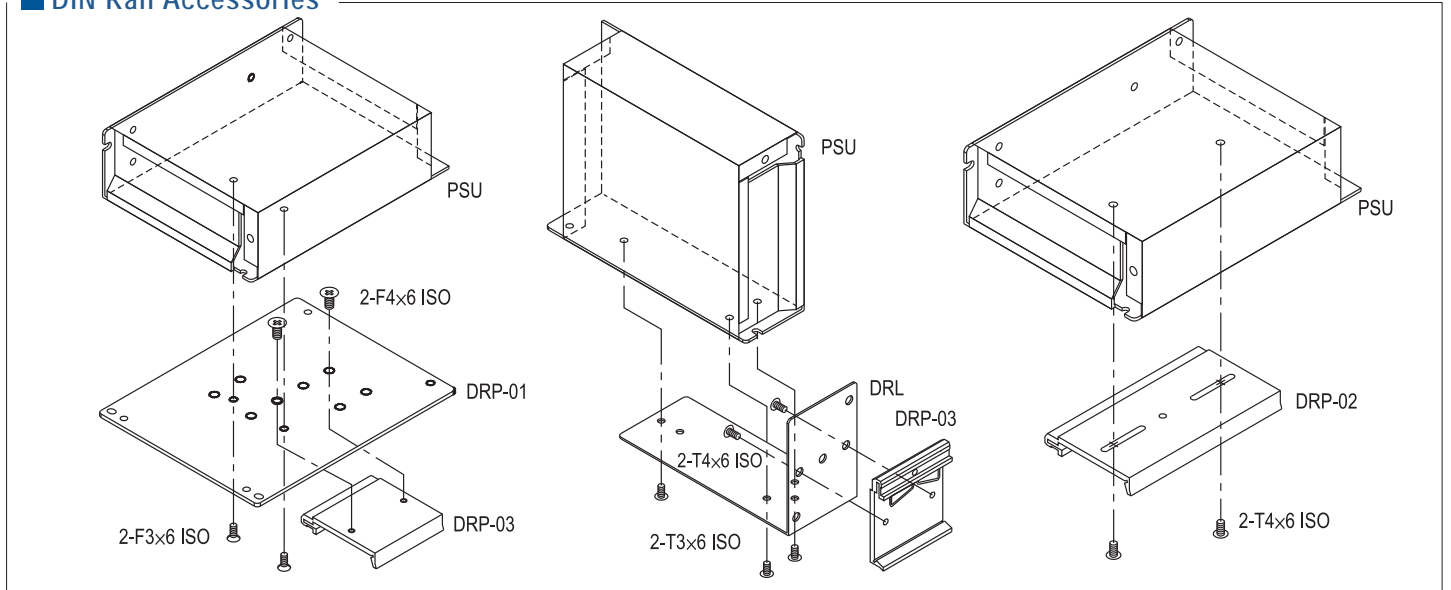

Mounting Accessories

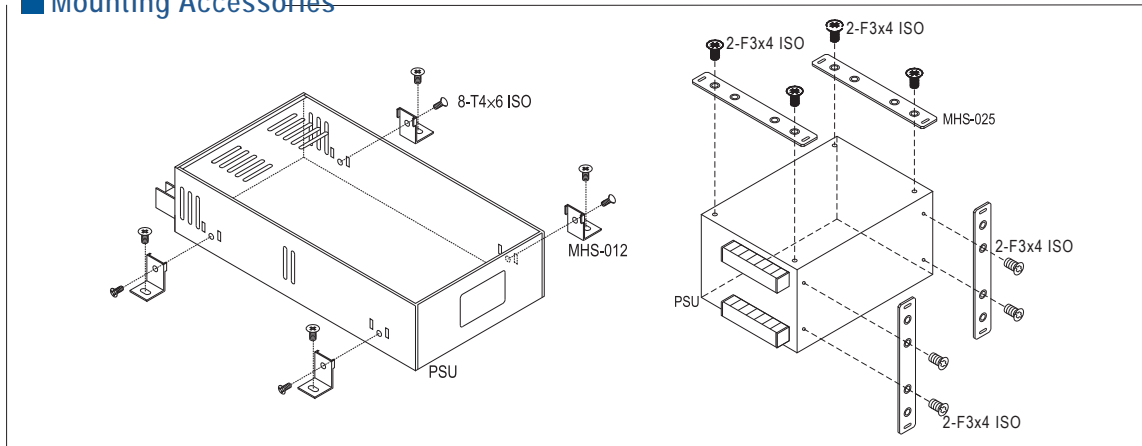

Photo

Order No.

DH12A40V

Power Schottky Rectifier
12A/40V
(26.97x 17.28x 13.98mm)

Photo	Order No.	Case	Model
	DRL-01	238, 239, 240 903 905 931 932 971	LRS-35/50/75/100 RS-25 RS-35 RS-15
	DRL-02	241 901 902 906 915 916 920	LRS-150/150F SD-100/150....
	DRL-03A	980 987	SP-240, HRP(G)-300
	DRP-01	238, 239, 241 901, 902 903, 906 931, 932, 946	LRS-35/50/100/150/150F All models
	DRP-01A	203 205 978 999	RSD-100 / 150 / 200 / 300
	DRP-02	240 905 / 915 916 / 920 928	LRS-75
	DRP-03	DRP-01 DRL-01-03	All models
	DRP-04	203 205 978 999	RSD-100 / 150 / 200 / 300

Photo	Order No.	Case	Model
	MHS012	206, 207 215A 912, 915 916, 935 939, 940 977, 980 982, 986 987, 995	HDP-190 RSP-200/320/500 LRS-200/350 RSP-150 SE-450/1000 MP450/650/1000 HRP-300/450/600 RSP-2400/3000
	MHS013	919 926	PSP-500 SE-600
	MHS014	212 952	RSP-750 RSP-1000, SD-1000
	MHS025	910	PSP-600.....
	MHS026	943	RSP-1500
	MHS027	971 931	RS-15 RS-25
	TBC-05	901 903 905 932 220 239A 240A	SD-50 RS-75 RS-50 RS-35 RSP-75 LRS-35/50 LRS-75
	TBC-07	901 902 903 905 906 215A 227A 238A 241A	RD-85, RS-100 RD-125 RS-150, SD-100, RD/RID-65 RD-50 SD-150 RSP-150 RSP-100 LRS-100 LRS-150, LRS-150F
	TBC-08	901 906	AD-155, ADD/ADS-155
	TBC-09	207	RSP-200/320, LRS-200/350

MEAN WELL Suzhou Intelligent Campus

As a pioneer in standard power supply industry, MEAN WELL targeting the trend of Intelligent Technology, Energy Conservation, and Renewable Energy. Together with our PBM partners and MEAN WELL's innovative solutions, we believe in creating a better future.



Production Management System

- MES
- Burn-in Power Recycling
- BLDC Motor Driver
- Sharewell Automation
- Cable Assembly Service



Building Automation Control Technology

- KNX
- CANBUS
- PMBUS
- PoE
- DALI



Environmental Monitoring System

- Gas Detection
- Temperature and Humidity Monitoring
- Air Quality Monitoring
- Regenerative Catalyst Oxidizer



Energy Management System

- Smart Power Meter
- Centralized Power System
- DC House
- UPS System
- Charging Station
- Solar Panel Applications
- Burn-in Power Recycling



◀ Visit

<https://expo.meanwell.com/future.html>



Property Management System

- Landscape Lighting
- Building Lighting
- Smart Light Poles
- Automatic Irrigation
- Rainwater Recycling



Security Monitoring System

- Fire Fighting System
- Broadcast Alert System
- Guard Tour Patrol System
- NVR Surveillance System



Access Control System

- All-in-one Access Card
- Facial Recognition
- Guest System
- Health Code
- Lane Gate and License Plate Recognition



Information & Telecom System

- Data Center
- Video conferencing
- Multimedia Advertising Kiosk
- Wi-Fi and 5G Networks
- Internal Display
- VOIP



Taiwan

明緯企業股份有限公司 (總部)
MEAN WELL ENTERPRISES CO., LTD. (HQ)
 24891 新北市五股區五權三路28號
 No.28, Wuquan 3rd Rd., Wugu Dist.,
 New Taipei City 24891, Taiwan (R.O.C.)
 統一編號 : 34491075
 Tel : +886-2-2299-6100(rep.)
 Fax: +886-2-2299-6200(rep.) +886-2-2298-0818(sales)
 E-mail: info@meanwell.com www.meanwell.com

China

明緯(廣州)電子有限公司
MEAN WELL (GUANGZHOU) ELECTRONICS CO., LTD.
 廣州市花都區花東鎮金谷南路11號
 No.11, Jingu South Road, Huadong Town,
 Huadu District, Guangzhou, Guangdong, China
 Tel : +86-20-3773-7100 / 400-800-3608(sales)
 +86-755-2359-1630(Shenzhen Office)
 +86-28-8546-8628(Chengdu Office)
 E-mail: info@meanwell.com.cn
 www.meanwell.com.cn

蘇州明緯科技有限公司
SUZHOU MEAN WELL TECHNOLOGY CO., LTD.
 江蘇省蘇州市相城區東橋鎮健民路77號
 No.77, Jian-Min Rd. Dong-Qiao Town,
 Xiang-Cheng District, Suzhou, Jiang-Su, China
 Post Code: 215152
 Tel : +86-512-6508-8600
 +86-10-5200-1817(Beijing Office)
 Fax: +86-512-6508-8700
 E-mail: info@meanwell.cc
 www.meanwell.cc

U.S.A.

MEAN WELL USA, INC.
 44030 Fremont Blvd., Fremont,
 CA 94538, U.S.A.
 Tel : +1-510-683-8886
 Fax: +1-510-683-8899
 E-mail: info@meanwellusa.com
 www.meanwellusa.com

Europe

MEAN WELL EUROPE B.V.
 Langs de Werf 8,1185XT Amstelveen,
 The Netherlands
 Tel : +31-20-758-6000
 Fax: +31-20-758-6001
 E-mail: info@meanwell.eu
 www.meanwell.eu



Please Contact Your Local Distributor



ІННОВАЦІЇ ТА
ПАРТНЕРСТВО

м. Київ, вул. Краківська, 13-Б
 +38 044 291-00-41
 info@sea.com.ua
 www.sea.com.ua

Офіційний дистриб'ютор MEAN WELL та TRACO POWER в Україні



This catalog is printed
with soy ink